



X1-Retro Fit User Manual

3.7kw - 5.0kw



EN



Solax Power Network Technology(Zhe jiang) Co., Ltd.

No.288 Shizhu Road, Tonglu Economic Development Zone,
Tonglu City, Zhejiang province, China.

Tel: +86 0571-56260011

E-mail: info@solaxpower.com

614.00204.04

Copyright Declaration

The copyright of this manual belongs to Solax Power Network Technology(Zhe jiang) Co., Ltd.. Any corporation or individual should not plagiarize, partially or fully copy (including software,etc.), and no reproduction or distribution of it in any form or by any means. All rights reserved. Solax Power Network Technology (Zhe jiang) Co.,Ltd. (SolaX Power Co.,Ltd.). reserves

www.solaxpower.com

Contents

1 Note on this Manual	03
1.1 Scope of Validity	03
1.2 Target Group	03
1.3 Symbols Used	03
2 Safety	04
2.1 Important Safety Instructions	04
2.2 Explanation of Symbols	08
2.3 EC Directives	09
3 Introduction	10
3.1 Basic Features	10
3.2 Work Status	12
3.3 Dimension	13
3.4 Terminals of Inverter	14
4 Technical Data	15
4.1 AC output/input (apply to version E, I, C)	15
4.2 Internal Charger (apply to version E, I, C)	15
4.3 Efficiency, Safety and Protection (apply to version E, I, C)	16
4.4 EPS output (apply to version E, I)	16
4.5 General Data (apply to version E, I, C)	17
5. Installation	18
5.1 Check for Transport Damage	18
5.2 Packing List	18
5.3 Mounting	19
6 Electrical Connection	22
6.1 Grid Connection	22
6.2 EPS Connection(apply to I Version and E Version)	24
6.3 Battery Connection	28
6.4 Earth Connection	31

6.5 Meter Connection..... 32
 6.6 485 Connection 34
 6.7 LAN Connection..... 36
 6.8 DRM Connection..... 38
 6.9 Other Communication Connection 40
 6.10 Monitoring Connection(optional)..... 41
 6.11 Inverter Manipulation..... 42

7. Firmware Upgrading 44

8. Setting 46

8.1 Control Panel 46
 8.2 Menu Structure 47
 8.3 LCD Operation 48

9 Troubleshooting 67

9.1 Trouble Shooting 67
 9.2 Routine Maintenance 71

10 Decommissioning 72

10.1 Dismantling the Inverter 72
 10.2 Packaging 72
 10.3 Storage and Transportation 72

1 Notes on this Manual

1.1 Scope of Validity

This manual is an integral part of X1-Retro Fit, It describes the assembly, installation, commissioning, maintenance and failure of the product. Please read it carefully before operating.

X1-Fit-3.7E	X1-Fit-4.6E	X1-Fit-5.0E
X1-Fit-3.7I	X1-Fit-4.6I	X1-Fit-5.0I
X1-Fit-3.7C	X1-Fit-4.6C	X1-Fit-5.0C

Note: **“3.7”** means 3.7kW.

“E” means “EPS function” will be available with an external changeover device installed.

“I” means “EPS function” available as unit already content an internal changeover device.

“C” means without “EPS function”.

Store this manual where it will be accessible at all times.

1.2 Target Group

This manual is for qualified electricians. The tasks described in this manual only can be performed by qualified electricians.

1.3 Symbols Used

The following types of safety instructions and general information appear in this document as described below:



Danger!
 “Danger” indicates a hazardous situation which, if not avoided, will result in death or serious injury.



Warning!
 “Warning” indicates a hazardous situation which, if not avoided, could result in death or serious injury.



Caution!
 “Caution” indicates a hazardous situation which, if not avoided, could result in minor or moderate injury.



Note!
 “Note” provides tips that are valuable for the optimal operation of our product.

2 Safety

2.1 Important Safety Instructions



Danger!

Danger to life due to high voltages in the inverter!

- All work must be carried out by qualified electrician.
- The appliance is not to be used by children or persons with reduced physical sensory or mental capabilities, or lack of experience and knowledge, unless they have been given supervision or instruction.
- Children should be supervised to ensure that they do not play with the appliance.



Caution!

Danger of burn injuries due to hot enclosure parts!

- During operation, the upper lid of the enclosure and the enclosure body may become hot.
- Only touch the lower enclosure lid during operation.



Caution!

Possible damage to health as a result of the effects of radiation!

- Do not stay closer than 20 cm to inverter for any length of time.



Warning!

- Authorized service personnel must disconnect AC power from inverter before attempting any maintenance or cleaning or working on any circuits connected to inverter.



WARNING !

- Do not operate the inverter when the device is running.



WARNING !

- Risk of electric shock!

- Prior to the application, please read this section carefully to ensure correct and safe application. Please keep the user manual properly.
- Accessories only together with the inverter shipment are recommended here. Otherwise may result in a risk of fire, electric shock, or injury to person.
- Make sure that existing wiring is in good condition and that wire is not undersized.
- Do not disassemble any parts of inverter which are not mentioned in installation guide. It contains no user-serviceable parts. See Warranty for instructions on obtaining service. Attempting to service the inverter yourself may result in a risk of electric shock or fire and will void your warranty.
- Keep away from flammable, explosive materials to avoid fire disaster.
- The installation place should be away from humid or corrosive substance.
- Authorized service personnel must use insulated tools when installing or working with this equipment.
- The unit contains capacitors that remain charged to a potentially lethal voltage after the MAINS and battery has been disconnected.
- Hazardous voltage will present for up to 5 minutes after disconnection from power supply.
- CAUTION-RISK of electric shock from energy stored in capacitor, Never operate on the inverter couplers, the MAINS cables or Battery cables when power is applied. After switching off the battery and Mains, always wait for 5 minutes to let the intermediate circuit capacitors discharge before unplugging battery inplug and MAINS couplers.
- When accessing the internal circuit of inverter, it is very important to wait 5 minutes before operating the power circuit or demounting the electrolyte capacitors inside the device. Do not open the device before hand since the capacitors require time to sufficiently discharge!
- Measure the voltage between terminals UDC+ and UDC- with a multi-meter (impedance at least 1Mohm) to ensure that the device is discharged before beginning work (35VDC) inside the device.
- Lightning will cause a damage either from a direct strike or from surges due to a nearby strike.
- Specialists in lightning protection should be consulted during the end use application.
- Using appropriate external lightning protection, the effect of a direct lightning strike into a building can be mitigated in a controlled way, and the lightning current can be discharged into the ground.
- Installation of SPDs to protect the inverter against mechanical damage and excessive stress include a surge arrester in case of a building with external lightning protection system (LPS) when separation distance is kept.
- To protect the AC system, surge suppression devices (SPD type2) should be fitted at the main incoming point of AC supply (at the consumer's cutout), located between the inverter and the meter/distribution system; SPD (test impulse D1) for signal line according to EN 61632-1.

► Anti-Islanding Effect

- Islanding effect is a special phenomenon that grid-connected system still supply power to the nearby grid when the voltage loss is happened in the power system. It is dangerous for maintenance personnel and the public.
- X1-Retro Fit series inverter provide Active Frequency Drift(AFD) to prevent islanding effect.

► PE Connection and Leakage Current

- The inverter incorporates a certified internal Residual Current Device (RCD) in order to protect against possible electrocution and fire hazard in case of a malfunction in the cables or the inverter. There are two trip thresholds for the RCD as required for certification (IEC 62109-2:2011). The default value for electrocution protection is 30mA, and for slow rising current is 300mA.
- If an external RCD is required by local regulations, check which type of RCD is required for relevant electric code. It recommends using a type-A RCD. The recommended RCD values is 100mA or 300mA unless a lower value is required by the specific local electric codes. When required by local regulations, the use of an RCD type B is permitted.



WARNING !

High leakage current!
Earth connection essential before connecting supply.

- Incorrect grounding can cause physical injury, death or equipment malfunction and increase electromagnetic.
- Make sure that grounding conductor is adequately sized as required by safety regulations.
- Do not connect the ground terminals of the unit in series in case of a multiple installation. This product can cause current with a d.c component, where a residual current operated protective (RCD) or monitoring (RCM) device is used for protection in case of direct or indirect contact, only an RCD or RCM of type B is allowed on the supply side of this product.

For United Kingdom

- The installation that connects the equipment to the supply terminals shall comply with the requirements of BS 7671.
- No protection settings can be altered.
- User shall ensure that equipment is so installed, designed and operated to maintain at all times compliance with the requirements of ESQCR22(1)(a).

For Australia and New Zealand

- Electrical installation and maintenance shall be conducted by licensed electrician and shall comply with Australia National Wiring Rules.

► Battery Safety Instructions

SolaX X1-Retro Fit series inverter should be worked with high voltage battery, for the specific parameters such as battery type, nominal voltage and nominal capacity etc., please refer to section 4.2.



As accumulator batteries may contain potential electric shock and short-circuit current danger, to avoid accidents that might be thus resulted, the following warnings should be observed during battery replacement:

- 1: Do not wear watches, rings or similar metallic items.
- 2: Use insulated tools.
- 3: Put on rubber shoes and gloves.
- 4: Do not place metallic tools and similar metallic parts on the batteries.
- 5: Switch off load connected to the batteries before dismantling battery connection terminals.
- 6: Only personal with proper expertise can carry out the maintenance of accumulator batteries.









2.2 Explanation of Symbols



This section gives an explanation of all the symbols shown on the inverter and on the type label.

• Symbols on the Inverter

Symbol	Explanation
	Operating Display.
	Battery communication is active.
	An error has occurred, please inform your installer immediately.

• Symbols on the Type Label

Symbol	Explanation
	CE mark. The inverter complies with the requirements of the applicable CE guidelines.
	TUV certified.
	RCM remark.
	SAA certification.
	Beware of hot surface. The inverter can become hot during operation. Avoid contact during operation.
	Danger of high voltages. Danger to life due to high voltages in the inverter!
	Danger. Risk of electric shock!
	Observe enclosed documentation.

	The inverter can not be disposed together with the household waste. Disposal information can be found in the enclosed documentation.
	Do not operate this inverter until it is isolated from battery and mains
	Danger to life due to high voltage. • There is residual voltage existing in the inverter after powering off, which needs 5 min to discharge. • Wait 5 min before you open the upper lid.

2.3 CE Directives

This chapter follows the requirements of the European low voltage directives, which contains the safety instructions and conditions of acceptability for the endues system, which you must follow when installing, operating and servicing the unit. If ignored, physical injury or death may follow, or damage may occur to the unit. Read this instructions before you work on the unit. If you are unable to understand the dangers, warnings, cautions or instructions, please contact an authorized service dealer before installing. Operating and servicing the unit.

The Grid connected inverter meets the requirement stipulated in Low Voltage Directive (LVD) 2014/35/EU and Electromagnetic Compatibility (EMC) Directive 2014/30/EU. The unit is based on:

EN 62109-1:2010 ; EN 62109-2:2011 ; IEC 62109-1(ed.1) ; IEC62109-2(ed.1)
EN 61000-6-3:2007+A:2011 ; EN 61000-6-1:2007 ; EN 61000-6-2:2005 ; EN 62477
The grid connected inverter leave the factory completely connecting device and ready for connection to the mains,the unit shall be installed in accordance with national wiring regulations. Compliance with safety regulations depends upon installing and configuring system correctly, including using the specified wires. The system must be installed only by professional assemblers who are familiar with requirements for safety and EMC. The assembler is responsible for ensuring that the end system complies with all the relevant laws in the country where it is to be used.

The individual subassembly of the system shall be interconnected by means of the wiring methods outlined in national/international such as the national electric code (NFPA) No.70 or VDE regulation 0107.

3. Introduction

3.1 Basic features

X1-Retro Fit Series is a high-quality inverter which can store energy into battery. The inverter can be used to optimize self consumption, store in the battery for future use or feed-in to public grid. Work mode depends on the battery and user's preference. It can provide power for emergency use during the grid lost by using the energy from battery.

► System Diagram

X1-Retro Fit Series is designed with two EPS versions for customer to choose based on the local rules.

EVersion applies to the wiring rules that requires the Live line and Neutral line of EPS must be disconnected with the Live line and Neutral line of grid. (applies to most countries)

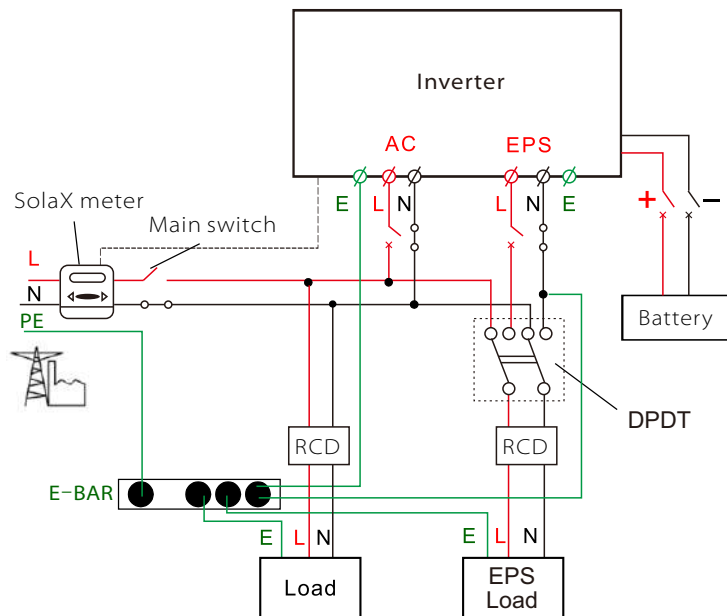

IVersion applies to the wiring rules that requires Neutral line of alternative supply must NOT be isolated or switched (applies to wiring rules AS/NZS_3000:2012 for Australia and New Zealand).

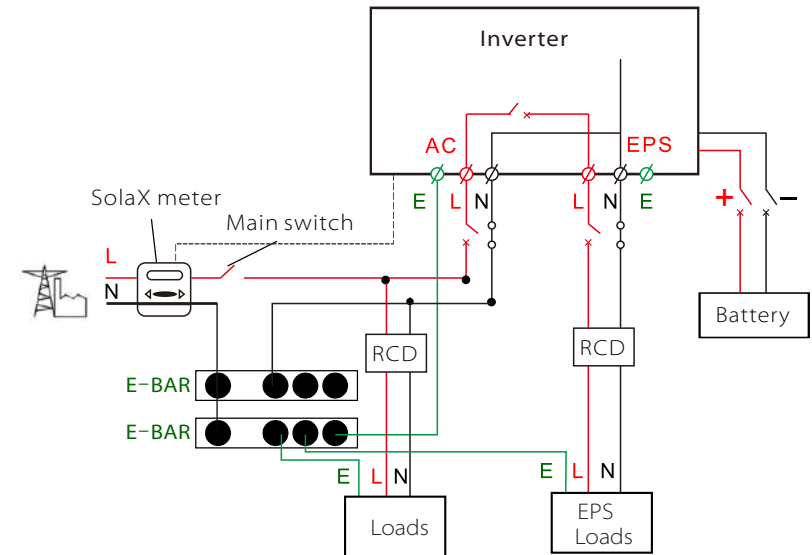

Note!

- Please control the home loads, and make sure it's within the "EPS output rating" under EPS mode, otherwise the inverter will shutdown with an "overload fault" warning.
- Please confirm with the mains grid operator whether there is any special regulations for grid connection.

3.2 Work Modes

X1-Retro Fit Series inverter provides multiple work modes based on different requirements.

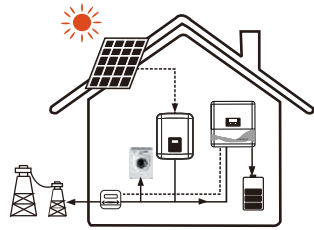

Work modes: **Self-use**

Priority: load>battery>grid

This mode applies the area that has low feed-in tariff and high energy price.

In the case of the external generator, the power generated will be used to supply the local loads firstly, then to charge the battery. The redundant power will export to the public grid.

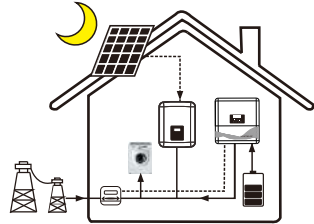

In the absence of the external generator, or the power is not enough, battery will discharge for local loads firstly, and grid will supply power when the battery capacity is not enough.

Work modes: **Force time use**

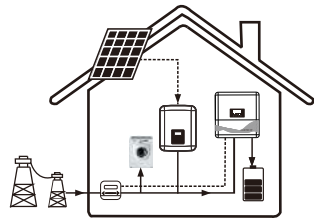

Priority:battery>load>grid(when charging)
Priority:load>battery>grid(when discharging)

This mode applies the area that has electricity price between peak and valley. User can use off-peak electricity to charge the battery.

The charging and discharging time can be set flexibly.

Work modes: **Feed in Priority**

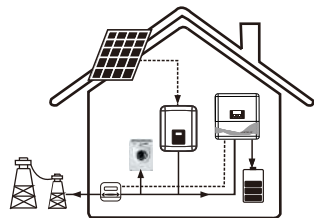

Priority:load>grid>battery

This mode applies the area that has high feed-in tariff and export control.

In the case of the external generator, the power generated will be used to supply the local loads firstly, then export to the public grid. The redundant power will charge the battery.

In the absence of the external generator, or

the power is not enough, battery will discharge for local loads firstly, and grid will supply power when the battery capacity and power generation is not enough.

Work modes: **Back up mode**

Priority:battery>load>grid

This mode applies the area that has frequent power outages. And this mode ensures the battery will have enough energy to supply when the grid is off.

In the case of external power generation equipment, the power generated will be used to charge the battery fully firstly, then supply the local loads. The redundant power will export to the public grid.

In the absence of an external power generation device, charge the battery with the public grid.

The inverter will switch to EPS mode only when the grid is abnormal.

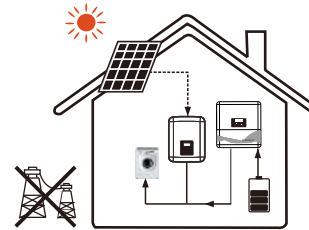
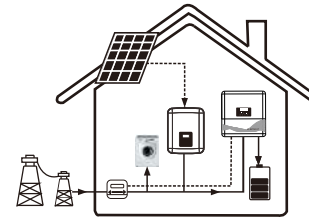

*** EPS Status**

When the grid is off, system will supply emergency power from battery to supply the home loads. (Battery is necessary in EPS mode.)

3.3 Dimension

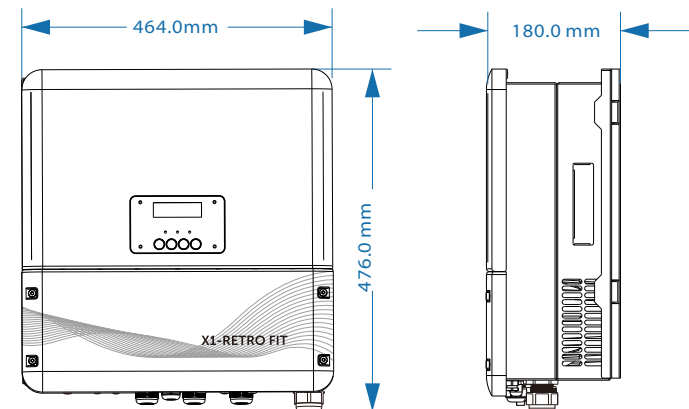

3.4 Terminals of inverter

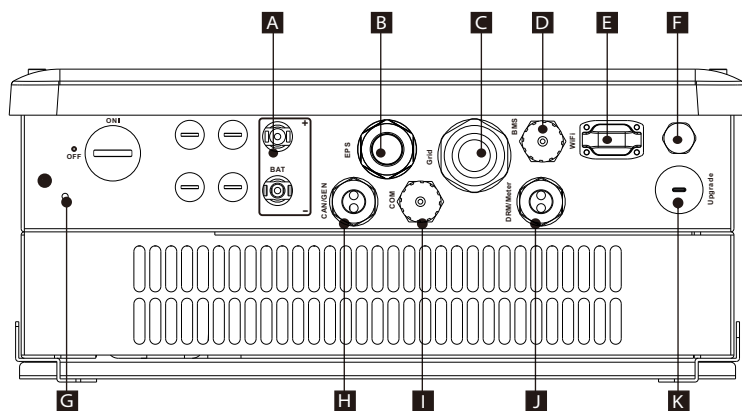

Object	Description
A	Battery connection area
B	EPS output
C	Grid output
D	Battery communication
E	Communication port for external Pocket WiFi/LAN/GPRS
F	Waterproof valve
G	Earthing screw
H	CAN/GEN communication port (reserved)
I	COM port for Ethernet/485 communication
J	DRM port / External meter port
K	USB port for upgrading

**WARNING !**

Qualified electrician will be required for the installation.

4. Technical Data

4.1 AC output/input (apply to version E, I,C)

Model	X1-Fit-3.7E X1-Fit-3.7I X1-Fit-3.7C	X1-Fit-4.6E X1-Fit-4.6I X1-Fit-4.6C	X1-Fit-5.0E X1-Fit-5.0I X1-Fit-5.0C
AC output			
Normal AC power[VA]	3680	4600	4999
Max. apparent AC power[VA]	3680	4600	4999
Rated grid voltage(range)[V]	220/230/240 VAC(180 to 270 VAC)		
Rated grid frequency[Hz]	50/60		
Normal AC current[A]	16	20	21.7
Max.AC current[A]	16	21	21.7
Displacement power factor	0.8 leading...0.8 lagging		
Total harmonic distortion(THDi)	< 2%		
Parallel operation	Being developed		
Load control	Being developed(optional)		
AC input			
Normal AC power[VA](E&C Version)	3680	4600	4999
Normal AC power[VA](I Version)	3680+4000(bypass)	4600+5000(bypass)	4999+5000(bypass)
Rated grid voltage(range)[V]	220/230/240 VAC (180 to 270 VAC)		
Rated grid frequency[Hz]	50/60		
Max.AC current[A](E&C Version)	16	21	21.7
Max. AC current[A](I Version)	16+21.7(bypass)	21+26.0(bypass)	21.7+26.0(bypass)
Displacement power factor	0.8 leading...0.8 lagging		
Normal AC current[A](E&C Version)	16	20	21.7
Normal AC current[A](I Version)	16+17.4(by pass)	20+17.4(by pass)	21.7+17.4(by pass)
AC inrush current[A]	35	35	35
AC maximum output fault current[A]	80	80	80

4.2 Internal Charger (apply to version E, I,C)

Model	X1-Fit-3.7E X1-Fit-3.7I X1-Fit-3.7C	X1-Fit-4.6E X1-Fit-4.6I X1-Fit-4.6C	X1-Fit-5.0E X1-Fit-5.0I X1-Fit-5.0C
Battery type	Lithium battery		
Battery voltage range[V]	85-400		
Recommended battery voltage[V]	300VDC		
Recommended battery capacity[kWh]	4.8-16.8		
Max. charge/discharge current[A]	20A(adjustable)		
Peak charge/discharge current[A]	30A		
Communication interfaces	CAN/RS485		
Reverse connect protection	Yes		

4.3 Efficiency, Safety and Protection (apply to version E, I,C)

Model	X1-Fit-3.7E X1-Fit-3.7I X1-Fit-3.7C	X1-Fit-4.6E X1-Fit-4.6I X1-Fit-4.6C	X1-Fit-5.0E X1-Fit-5.0I X1-Fit-5.0C
Max. Battery charge efficiency AC to BAT)(@full load)	95.60%	95.60%	95.60%
Max. Battery discharge efficiency (BAT to AC)(@full load)	97.00%	97.00%	97.00%
Max. efficiency	97.00%	97.00%	97.00%

Safety & Protection	
Over/under voltage protection	YES
DC isolation protection	YES
Monitoring ground fault protection	YES
Grid protection	YES
DC injection monitoring	YES
Residual current detection	YES
Anti-islanding protection	YES
Over load protection	YES
Over heat protection	YES

4.4 EPS output (apply to version E, I)

Model	X1-Fit-3.7E X1-Fit-3.7I	X1-Fit-4.6E X1-Fit-4.6I	X1-Fit-5.0E X1-Fit-5.0I
EPS rated power[VA]	4000	5000	5000
Max. EPS power[VA]	5000	6000	6000
EPS rated voltage[V], Frequency[Hz]	230VAC, 50/60		
EPS rated current[A]	17.4	21.7	21.7
Max. EPS current[A]	21.7	26.0	26.0
EPS peak power[W]	6000,10s	8000,10s	
Switch time[s]	<500ms(for verstion E), <20ms(for version I)		
Total harmonic distortion(THDv)	<2%		
Changeover device(E Version)	external		
Changeover device(I Version)	internal		

4.5 General Data (apply to version E, I, C)

Model	X1-Fit-3.7E X1-Fit-3.7I X1-Fit-3.7C	X1-Fit-4.6E X1-Fit-4.6I X1-Fit-4.6C	X1-Fit-5.0E X1-Fit-5.0I X1-Fit-5.0C
Dimension [W/H/D](mm)	476*464*180		
Dimension of packing [W/H/D](mm)	600*540*350		
Net weight [kg]	23		
Gross weight [kg]	26		
Operating temperature range[°C]	-20~+60 (derating at 45)		
Storage temperature [°C]	-20~+60		
Storage/Operation relative humidity	4%~95% (without condensing)		
Altitude [m]	<2000		
Ingress Protection	IP65		
Protective Class	I		
Over Voltage Category	III(electric supply side), II(battery side)		
Cooling	Nautral		
Noise emission(typical)	<40dB		
Inverter Topology	Transformerless		
Communication interface	485,Ethernet, Meter, pocket WIFI/LAN/GPRS(optional), DRM, USB		
LCD display	Backlight 20*4 character		
Installation	Wall-mounted		
Night-time consumption	<3W		
Pollution Degree	III		

5. Installation

5.1 Check for Physical Damage

Make sure the inverter is intact during transportation. If there is any visible damage, such as cracks, please contact your dealer immediately.

5.2 Packing List

Open the package and take out the product, please check the accessories first. The packing list shown as below.

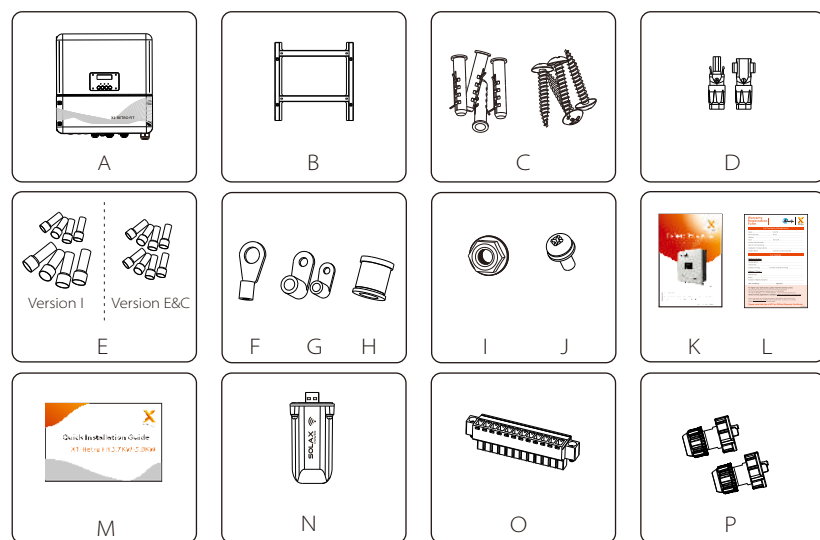

Object	Description
A	Inverter
B	Bracket
C	Expansion tubes & Expansion screws
D	Battery connectors (1*positive, 1*negative)
E	4 6AWG AC terminals and 4 10AWG AC terminals for Version I 8 10AWG AC terminals for Version E and Version C
F	Ring terminal(1*for external enclosure grounding)
G	Ring terminal(2*for internal enclosure grounding)

Object	Description
H	gasket(for using thin cable to connect on the AC port)
I	Grounding nut
J	Set screw(for mounting)
K	User manual
L	Warranty card
M	Quick installation guide
N	Pocket wifi/LAN/GPRS (optional)
O	12 pin positive terminal
P	cable connector*2

5.3 Mounting

➤ Installation Precaution

X1-Retro Fit Series inverter is designed for outdoor installation (IP 65). Make sure the installation site meets the following conditions:

- Not in direct sunlight.
- Not in areas where highly flammable materials are stored.
- Not in potential explosive areas.
- Not in the cool air directly.
- Not near the television antenna or antenna cable.
- Not higher than altitude of about 2000m above sea level.
- Not in environment of precipitation or humidity (>95%).
- Under good ventilation condition.
- The ambient temperature in the range of -20°C to +60°C.
- The slope of the wall should be within $\pm 5^\circ$.
- The wall hanging the inverter should meet conditions below:
 - 1.solid brick/concrete, or strength equivalent mounting surface;
 - 2.Inverter must be supported or strengthened if the wall's strength isn't enough(such as wooden wall, the wall covered by thick layer of decoration)

Please AVOIDE direct sunlight, rain exposure, snow laying up during installation and operation.

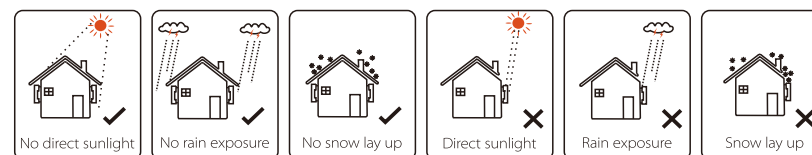

➤ Space Requirement

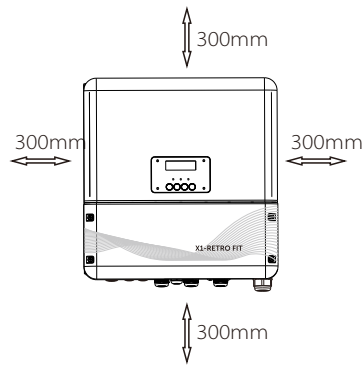

Table Available Space Size

Position	Min.size
Left	300mm
Right	300mm
Top	300mm
Bottom	300mm
Front	300mm

➤ Mounting Steps

Tools required for installation.

Installation tools : crimping pliers for binding post and RJ 45, screwdriver, manual wrench and $\varnothing 10$ drill.



Step 1: Screw the wall bracket on the wall

- 1.1 Place the bracket on the wall and mark down the position of the 4 holes.
- 1.2 Drill holes with driller, make sure the holes are deep enough (at least 60mm) to support the inverter.
- 1.3 Install the expansion tubes in the holes, and tighten them. Then install the wall bracket with the expansion screws.

Step 2: Place the inverter on the wall mounted bracket by holding the handle on the side.

Step 3: Screw the set screw on the left-bottom of inverter tightly.

Step 4: If necessary, customer can install an anti-theft lock on the left-bottom of the inverter.

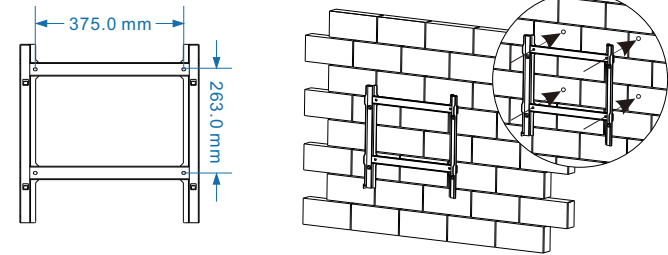

Step 1

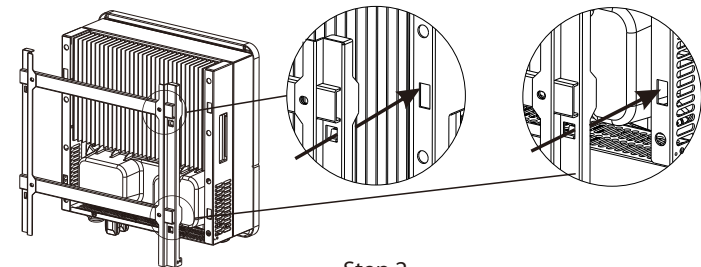

Step 2

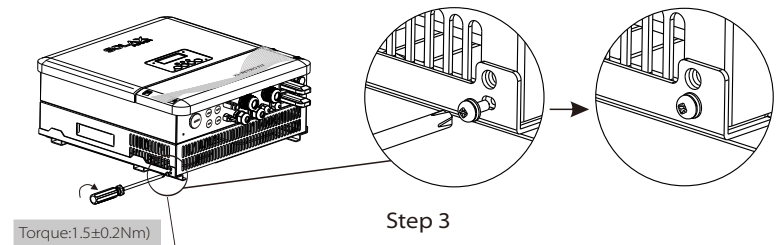

Step 3

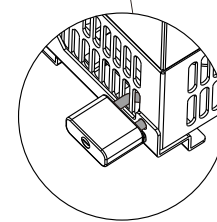

Step 4

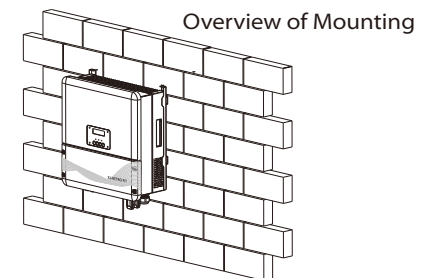

6. Electrical Connection

6.1 Grid Connection

X1-Retro Fit series inverter are designed for single phase grid. Voltage is 220/230/240V, frequency is 50/60Hz. Other technical requests should comply with the requirement of the local public grid.

Table 4 Cable and Micro-breaker recommended

Model	X1-Fit-3.7E X1-Fit-3.7I X1-Fit-3.7C	X1-Fit-4.6E X1-Fit-4.6I X1-Fit-4.6C	X1-Fit-5.0E X1-Fit-5.0I X1-Fit-5.0C
E Version & C Version			
Cable	4-5mm ²	5-6mm ²	5-6mm ²
Micro-breaker	20A	32A	32A
I Version			
Cable	8-10mm ²	10-13mm ²	10-13mm ²
Micro-breaker	50A	63A	63A

Micro-breaker should be installed between inverter and grid, any load should not be connected with inverter directly.

Connection Steps:

Step1. Check the grid voltage.

- 1.1 Check the grid voltage and compare with the permissive voltage range (Please refer to technical data).
- 1.2 Disconnect the circuit-breaker from all the phases and secure against re-connection.

Step2. Remove the top-down cover from the inverter.

Step3. Make AC wires.

- 3.1 Choose the appropriate wire(Cable size: refer to Table 4).
- 3.2 Reserve about 60mm of conductor material sectional area.
- 3.3 Remove 12mm of insulation from the end of wire.
- 3.4 Insert stripped wires into AC terminal and insure all conductor strands are captured in the AC terminal.
- 3.5 Compress the AC terminal head by using a crimping pliers and screw down screw cap tightly.

Step4. Insert AC cable into Grid port through screw cap and then tighten the screw cap. Insert L wire and N wire into corresponding ports of AC terminal. Compress the PE wire with earth terminal, then screw it on the grounding stud.

Step2.

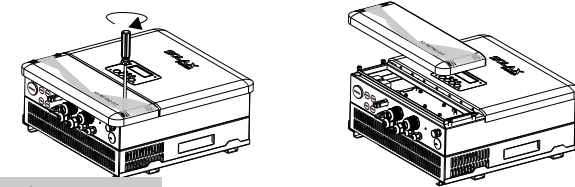

Φ4 hexagon wrench.torque:3+0.1Nm

Step3.

Cable Size: Refer to Tabel 4(page 24)

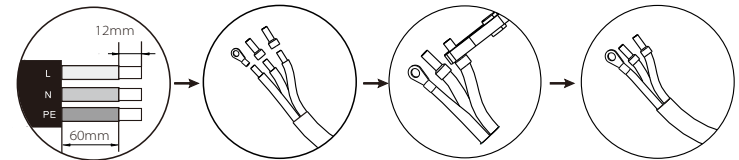

Step4.

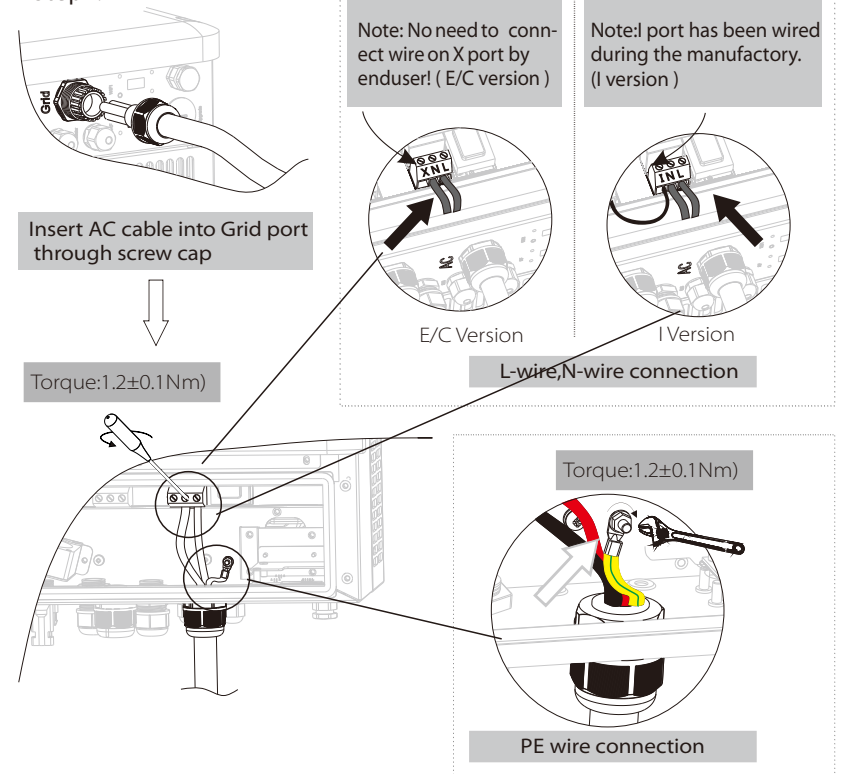

6.2 EPS Connection(apply to I Version and E Version only)

X1-Retro Fit series inverter has On and Off grid function, the inverter will deliver output power through AC port when the grid is on, and it will deliver output power through EPS port when the the grid is off.

➤ I Version & E Version

X1-Retro Fit series inverter provides two versions for customer to choose based on the local rules.

“**I Version**” means inverter has an build-in changeover switch. This version applies to the wiring rules which requires Neutral line of alternative supply must not be isolated or switched.(applies to wiring rules AS/NZS3000:2014 of Australia and New Zealand.)

“**E Version**” means inverter needs to install an external changeover device for EPS function. This version applies to the wiring rules which allows Neutral line of alternative supply can be isolated or switched.(applies to most of the countries)

➤ Auto & Manual

EPS function can be achieved automatically or manually according to user’s wishes. For “**I Version**” inverter, EPS function can only be triggered automatically.

For “**E Version**” inverter, EPS function can be triggered either automatically or manually according to user’s preference.

If user wants to use this function manually, it will need to be installed an external switch. Please refer to specific wiring diagram below. For automatical solution, please contact our sales.

• I Version • Auto • Do not required for Changeover Switch

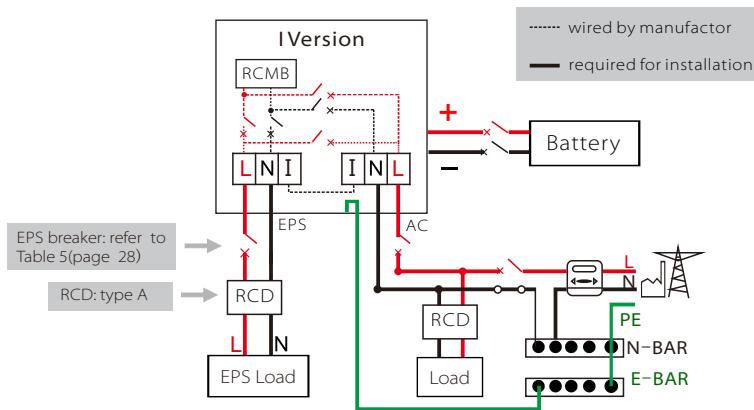

• E Version • Manual • Required for Changeover Switch

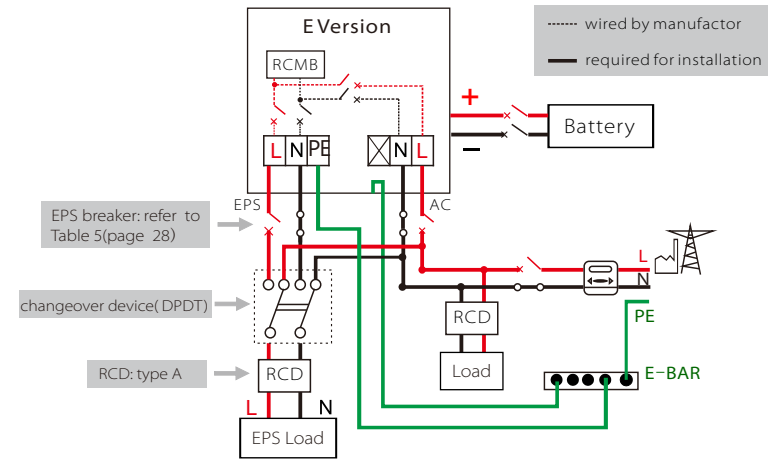

• E Version • Auto • Required for Changeover Switch

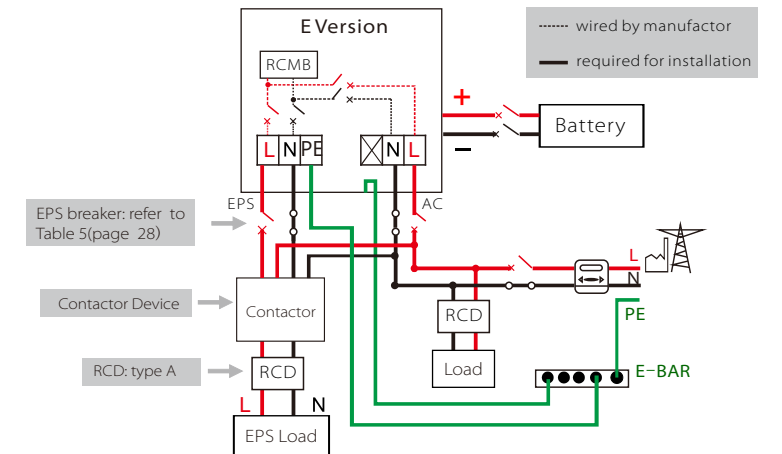

Please contact our sales for any compatible contactor purchase requirement .



Note!

In case of discrepancies between wiring mode of local policy and the operation guide above, especially for the wiring of neutral line, grounding and RCD, please contact us before any operation!

➤ Connection Steps:

Step1. Make EPS wires.

- 3.1 Choose the appropriate wire (cable size: refer to picture below).
- 3.2 Reserve about 60mm of conductor material sectional area.
- 3.3 Remove 12mm of insulation from the end of wire.
- 3.4 Insert stripped wires into AC terminal and insure all conductor strands are captured in the AC terminal.
- 3.5 Compress the AC terminal head by using a crimping pliers and screw down screw cap tightly.

Step2. Insert EPS cable into EPS port through screw cap and then tighten the screw cap. Insert L wire, N wire and PE wire (PE wire applies to E Version only) into corresponding ports of EPS terminal and screw them tightly.

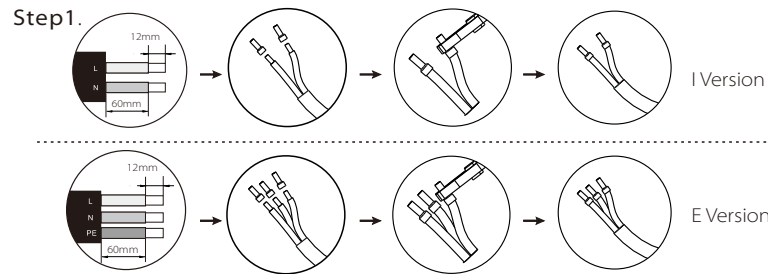
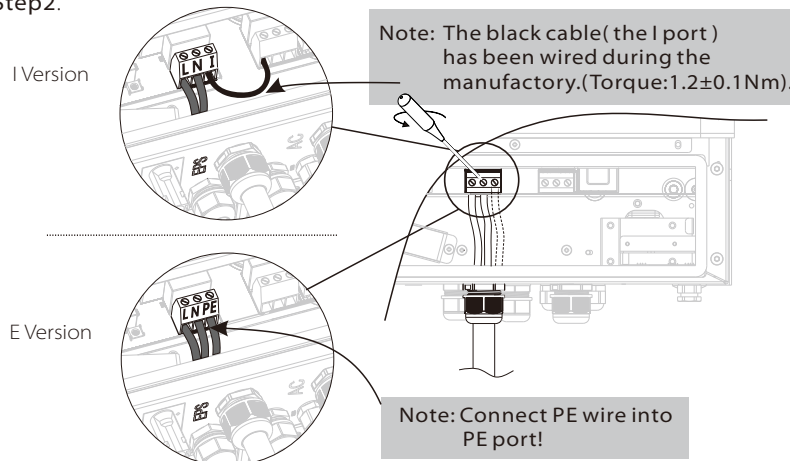

Table 5 Cable and Micro-breaker recommended

Model	X1-Fit-3.7E X1-Fit-3.7I X1-Fit-3.7C	X1-Fit-4.6E X1-Fit-4.6I X1-Fit-4.6C	X1-Fit-5.0E X1-Fit-5.0I X1-Fit-5.0C
EPS Cable	≥5mm ²	≥5mm ²	≥5mm ²
EPS breaker	25A	32A	32A

Step2.



➤ Requirements for EPS load

WARNING !
Make sure the EPS load power rating is within EPS output rating, otherwise the inverter will shutdown with an "over load" warning.



When an "over load" is appeared, adjust the load power to make sure it is within the EPS output power range, then turn the inverter back on.

For the nonlinear load, please make sure the inrush power should be within the EPS output power range.

Configuration current less than the maximum dc input current, generally lithium and lead acid capacity and voltage are linear decline.

Below table shows some common feasible loads for you reference.

Note: Please check with the manufacturer for high power inductive load.

Type	Power		Common equipment	Example		
	Start	Rated		Equipment	Start	Rated
Resistive load	X 1	X 1	Incandescent lamp TV	Incandescent lamp 100W	100VA (W)	100VA (W)
Capacitive load	X 2	X 1.5	Fluorescent lamp	Fluorescent lamp 40W	80VA (W)	60VA (W)
Inductive load	X 3~5	X 2	Fan Fridge	Fridge 150W	450-750VA (W)	300VA (W)

6.3 Battery Connection

Charging & discharging system of X1-Retro Fit series inverter is designed for **high-voltage lithium battery**.

Before choosing battery, please note the maximum voltage of battery can not exceed **400V** and the rated voltage of battery can not exceed **350V**, and the battery communication should be compatible with X1-Retro Fit inverter.

➤ Battery breaker

Before connecting to battery, please install a nonpolarized DC breaker to make sure inverter can be securely disconnected during maintenance.

Model	X1-Fit-3.7E X1-Fit-3.7I X1-Fit-3.7C	X1-Fit-4.6E X1-Fit-4.6I X1-Fit-4.6C	X1-Fit-5.0E X1-Fit-5.0I X1-Fit-5.0C
Voltage	Nominal voltage of DC breaker should be larger than maximum voltage of battery.		
Current[A]	32A		

➤ Battery connection diagram

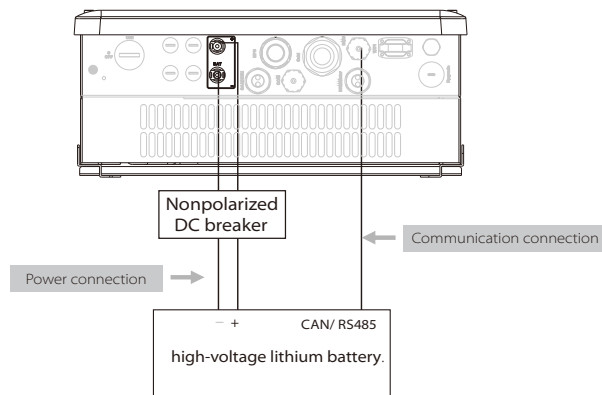

➤ Configuration table between inverter and battery

X1-Retro fit inverter (BAT voltage range is 80V - 400V)

Battery brand	Number of manager system	Number of battery module
SOLAX triple power (43AH, 63AH)	1 pcs(necessary) (model: MC0500)	1-3 pcs (model: HV10045/HV10063)
SOLAX triple power (50AH)	1 pcs(necessary) (model: T-BAT H5.8)	0-2 pcs (model: HV11550)
Pylontech	1 pcs(necessary) (model: SC0500A-100S)	2-7 pcs (model: H48050-15S)
other brand	Please contact SOLAX	

➤ BMS PIN Definition

Communication interface between inverter and battery is RS485 or CAN with a RJ45 connector.

PIN	1	2	3	4	5	6	7	8
Definition	X	GND	GND	BMS_CANH	BMS_CANL	X	BMS_485A	BMS_485B

➤ Power Connection Steps:

- Step1.** Choose the 9 AWG wire and strip the cable to 15mm.
- Step2.** Insert the stripped cable up to the stop (negative cable for DC plug(-) and positive cable for DC socket(+) are live). Hold the housing on the screw connection.
- Step3.** Press down spring until it clicks audibly into place.(The live wire must be visible in the chamber)
- Step4.** Tighten the screw connection(tighten torque:2.0Nm)
- Step5.** Plug the battery connectors into the corresponding BAT port of inverter.

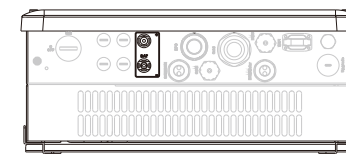
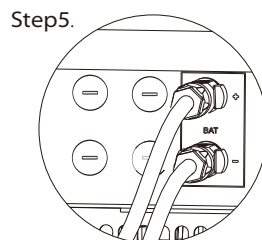
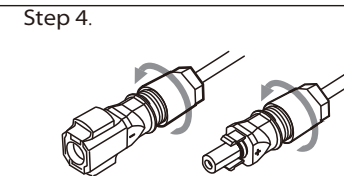
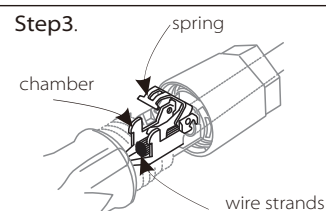
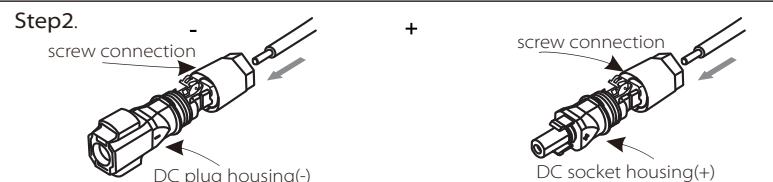

Note: The positive line and negative line are not allowed to access anti-Line.

➤ **Communication Connection Steps:**

Step1. Prepare a standard network cable (without sheath) and find the cable connector in the accessories package .

Step2. Insert the network cable through the cable connector, then crimp the cable with a Rj45 plug which is inside of the cable connector.

Step3. Insert the cable connector into BMS port inside of inverter and screw it tightly. Then insert other side of communication cable into RS485 or Can port on the battery.

Battery BMS module (Pylontech: RS485 port; Triple Power: CAN port; Please check the battery manual for more details)

Step1

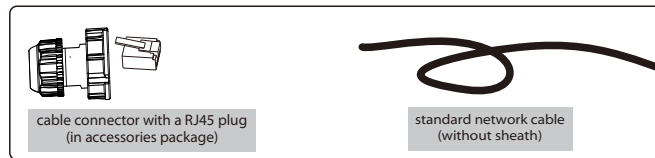

Step2

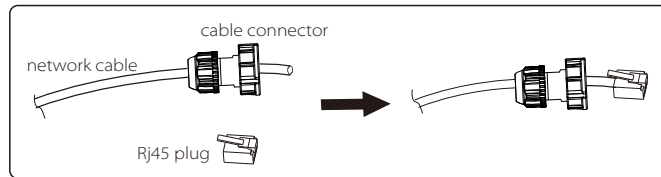

Step3

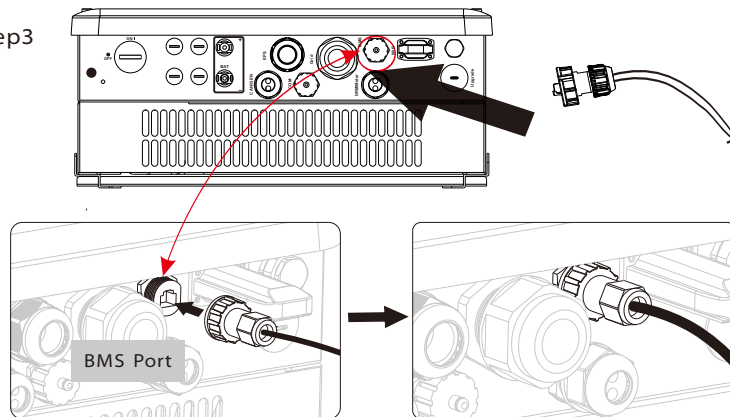

6.4 Earth Connection (mandatory)

Users must additionally earth the inverter to the enclosure of a second earthing or equipotential bonding. This prevents electric shock if the original protective conductor fails.

➤ **Earth Connection Steps:**

Step1. Strip the earthing cable insulation and insert the stripped cable into the ring terminal, then clamp it .

Step2. Place the ring terminal into the earthing rod and screw the earthing screw tightly.

Step1

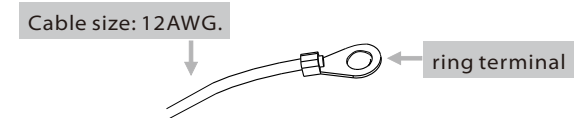

Step2

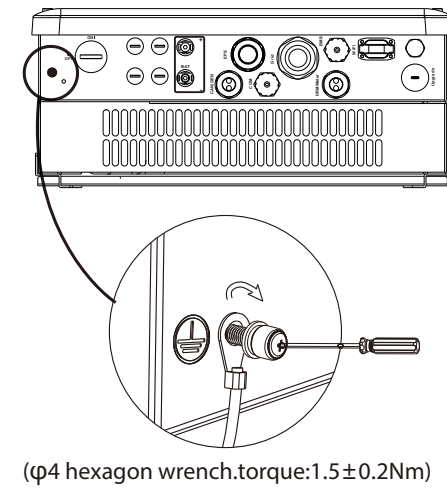

6.5 Meter Connection

X1-Retro fit inverter should work with a Meter for monitoring the power usage. A meter could deliver the data to inverter to achieve the export control function. Please note that it is necessary to use the meter brand recommended by SOLAX.

Note!
 It is necessary to connect meter to inverter otherwise inverter will shutdown with a "Meter fault" alert, unless the meter function is shut down though LCD operation. The smart meter must be authorized by Solax, any third party or non-authorized meter may not match with the inverter.
 Solax will not take the responsibility if the meter is unavailable.

➤ Meter connection diagram

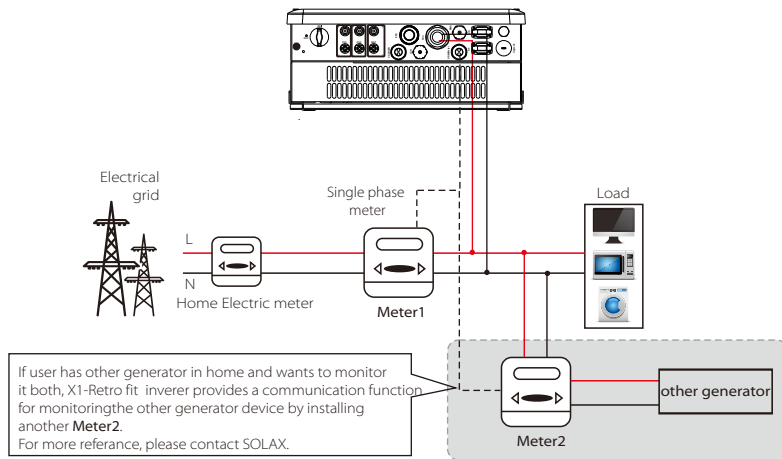

➤ Meter PIN Definition

Communication interface between inverter and meter is RS485 with two wires. Note: please make sure meterA and meterB is connected to port RS485A and RS485B on the meter.

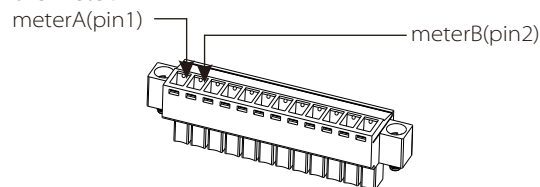

➤ Meter Connection Steps:

- Step1.** Prepare a connector and two communication wires.
- Step2.** Unscrew the nut of Meter connector and insert two communication wires through it.
- Step3.** Strip the insulation from the communication wires, then insert one side of wires into pin1 and pin2 holes of the 12 pin positive terminal which can be found in accessories package. And then screw them tightly.
- Step4.** Insert the positive terminal into the corresponding negative terminal block inside of the inverter. And then screw it tightly.

Step1

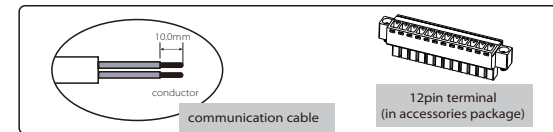

Step2

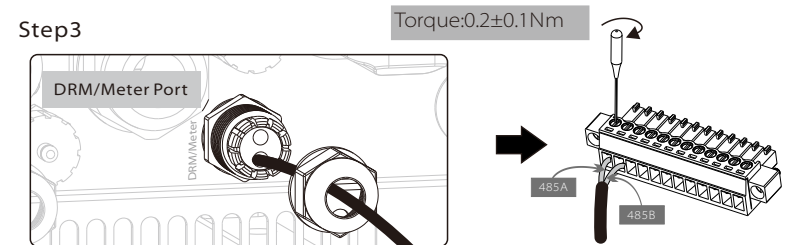

Step3

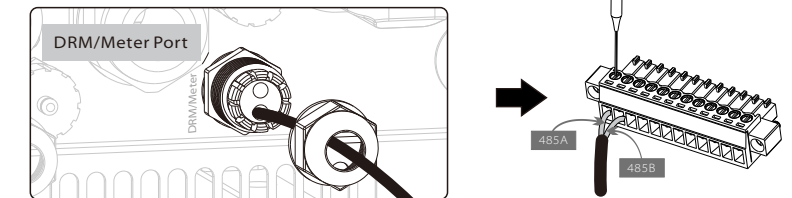

Step4

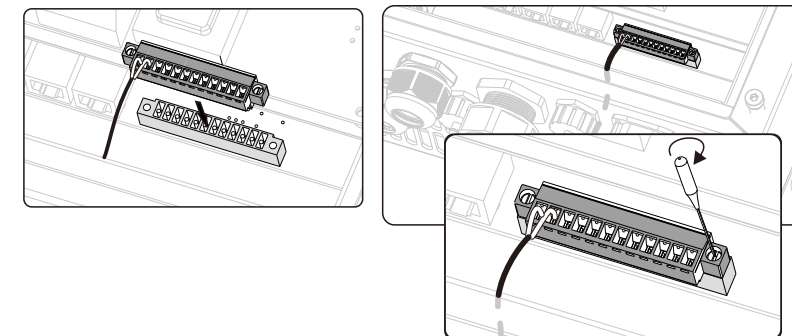

6.6 485 Connection

485 communication is the standard communication interface. It can transmit the data from inverter to PC or other monitoring equipments.



➤ 485 PIN Definition

	1	2	3	4	5	6	7	8
	X	X	GND	485A	485B	X	X	X

➤ Communication Connection Steps:

Step1. Prepare a standard network cable (without sheath) and find the cable connector in the accessories package .

Step2. Insert the network cable through the cable connector, then crimp the cable with a RJ45 plug which is inside of the cable connector.

Step3. Insert the cable connector into COM port at the bottom of inverter and screw it tightly. Then insert other side of the network cable into PC or other device.

Step1



Step2

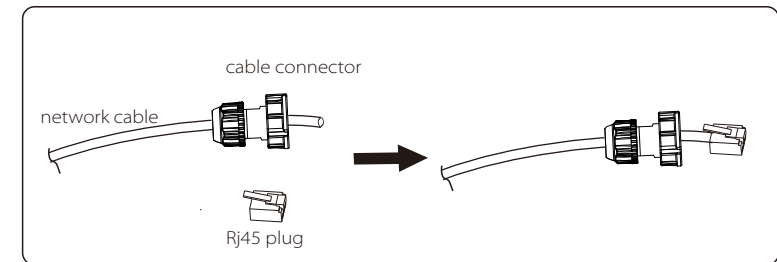

Step3

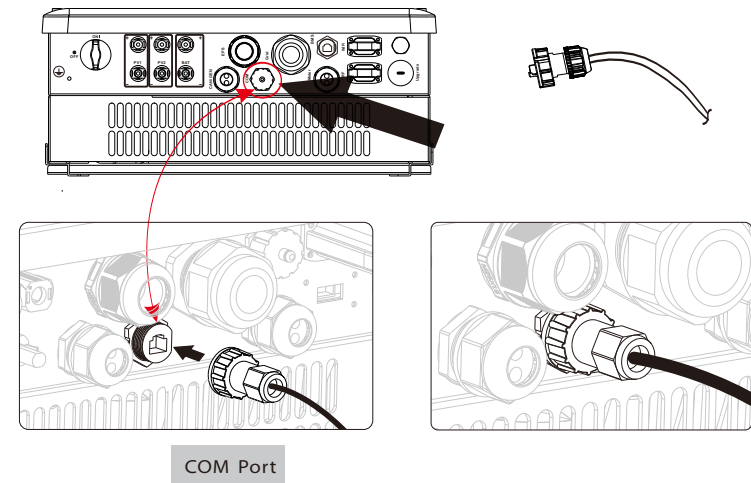

6.7 LAN Connection

LAN communication is the standard communication interface.

➤ Application Occasion

This function is applicable for the below situation:

I) for data transmission: It can transmit the inverter data from inverter to PC or other monitoring equipments.

II) for monitoring: It can transmit the inverter data from inverter to SOLAX monitoring website/APP through home router connected.

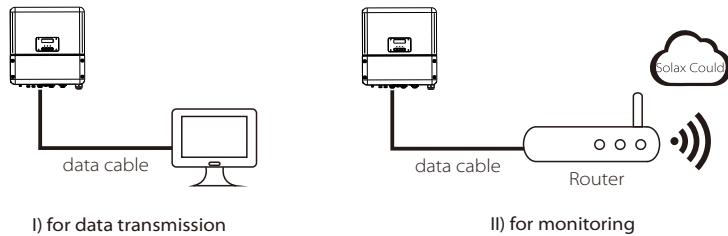

➤ LAN PIN Definition

	1	2	3	4	5	6	7	8
	TX+	TX-	RX+	X	X	RX-	X	X

➤ Communication Connection Steps:

Note!
 485 communication and LAN communication have respective RJ45 port interface inside of the inverter. But they share the same connection port (COM port) on the bottom of the inverter. 485 communication is default, if user wants to use LAN function, it needs to open the lid cover to operate

Step1. Open the lid cover, then it can be seen that a network cable has been inserted in the 485 RJ45 port.

Step2. Pull out the network cable, then insert it into the LAN RJ45 Port tightly.

Step3. for the external network cable operation, please refer to 485 connection steps.

Step1

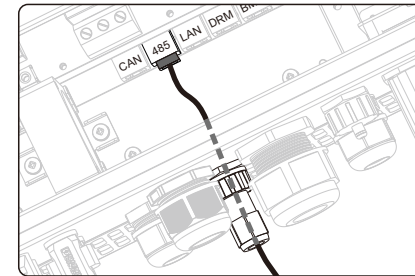

Step2

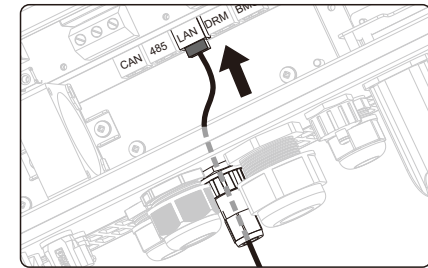

Step3

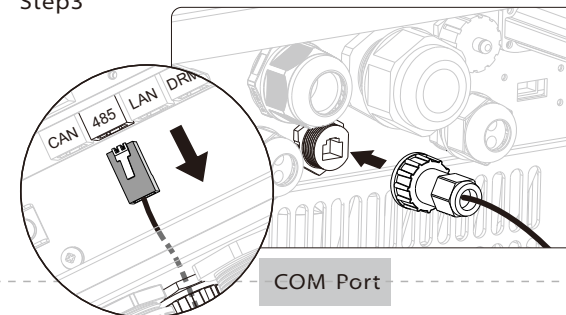

6.8 DRM Connection

DRM is provided to support several demand response modes by emitting control signals as below.

Mode	Requirement
DRM0	Operate the disconnection device
DRM1	Do not consume power
DRM2	Do not consume at more than 50% of rated power
DRM3	Do not consume at more than 75% of rated power AND Source reactive power if capable
DRM4	Increase power consumption (subject to constraints from other active DRMs)
DRM5	Do not generate power
DRM6	Do not generate at more than 50% of rated power
DRM7	Do not generate at more than 75% of rated power AND Sink reactive power if capable
DRM8	Increase power generation (subject to constraints from other active DRMs)

➤ DRM PIN Definition

	1	2	3	4	5	6	7	8
	DRM1/5	DRM2/6	DRM3/7	DRM4/8	+3.3V	DRM0	GND	GND

Note: Only PIN6(DRM0) and PIN1(DRM1/5)are available now, and other PIN functions are being developed.

➤ DRM Connection Steps:

- Step1.** Prepare a standard network cable (without sheath) and a RJ45 plug.
- Step2.** Insert the network cable through the DRM/Meter port on the bottom of the inverter.
- Step3.** Crimp the network cable with the RJ45 plug by using a cable clamp.
- Step3.** Insert the RJ45 plug into the DRM port, and screw the cable nut tightly.

Step1



Step2

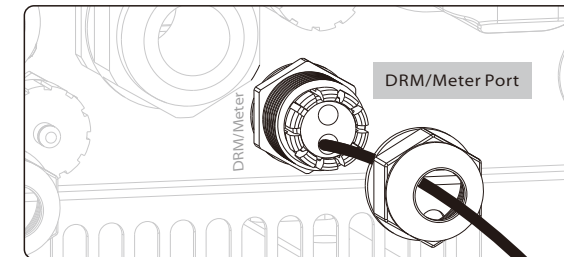

Step3

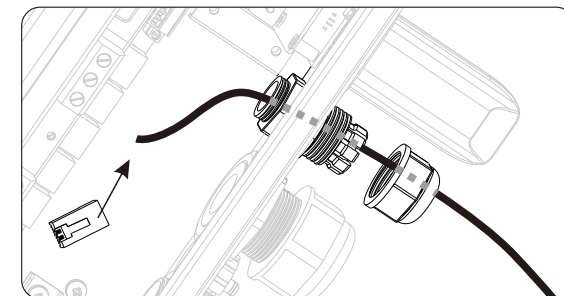

Step4

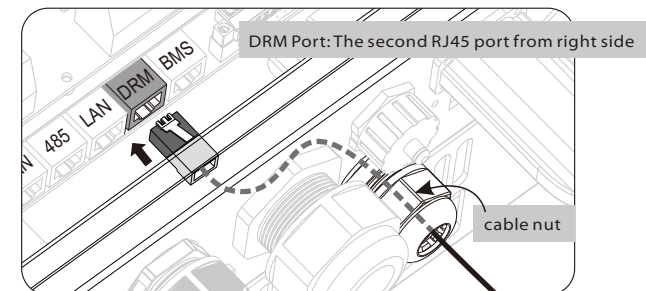

6.9 Other Communication Connection

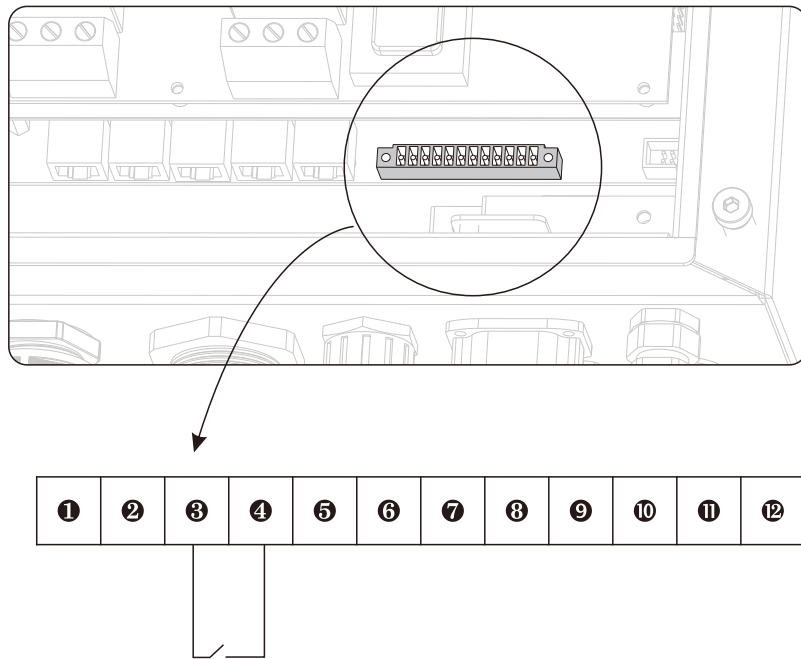

1&2 for meter connection(refer to page X)

3&4 Turn off the switch to shut down the inverter remotely.

5 & 6 & 7 & 8 & 9 & 10 & 11 & 12 Seven ports are reserved.

6.10 Monitoring Connection(optional)

Inverter provides a monitoring port which can collect data from inverter and transmit it to monitoring-website via an external monitoring data collector. SolaX could provide three type monitoring data collector, and they are Pocket wifi, Pocket LAN and Pocket GPRS. User could choose an appropriate Pocket according to network environment. (Purchase the product from supplier if needed)

➤ Pocket Wifi Connection Diagram

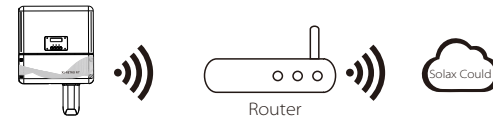

➤ Pocket LAN Connection Diagram

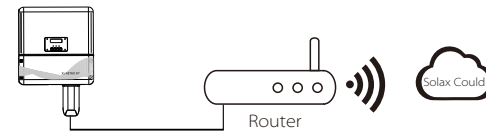

➤ Pocket GPRS Connection Diagram



➤ WiFi Connection Steps:

Step1. Plug Pocket Wifi into "WiFi" port at the bottom of the inverter.

Step2. Build the connection between the inverter and router.

Step3. Create a user account online.(Please check the Pocket WiFi user manual for more details.)

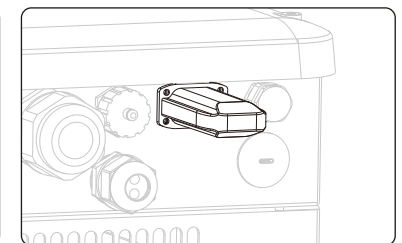
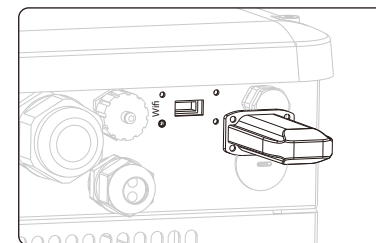

6.11 Inverter Manipulation

➤ Start inverter after checking all below steps:

- ❶ Ensure the inverter fixed well on the wall.
- ❷ Make sure all the AC wirings are completed.
- ❸ Make sure the meter is connected well.
- ❹ Make sure the battery is connected well.
- ❺ Make sure the external EPS contactor is connected well. (if needed)
- ❻ Turn on the AC breaker, EPS breaker and battery breaker.
- ❼ Long-press the "Enter" key for five seconds to exit Off Mode.(The mode is Off Mode when you use it for the first time; Factory default: Off Mode)

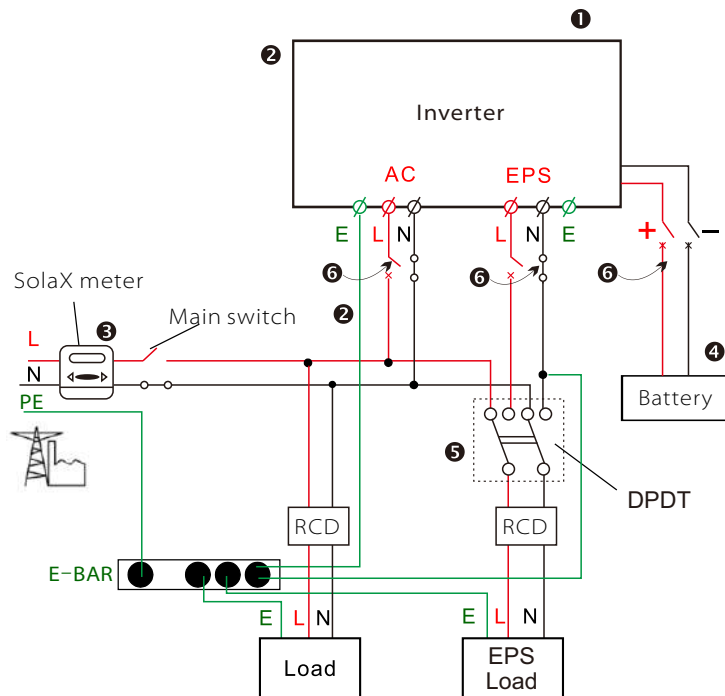

➤ Check the inverter:

Step1. Check the status of indicators and LCD screen. The left indicator should be blue and the indicator screen should display the main interface.

Note!  If the left indicator is not blue please check below the two points:
 - All the connections are correct.
 - All the external breakers are switched on.

Step2. There is a setting guide on the LCD screen if it is the first time to start up, pls follow it. For specific setting, please refer to section 8 (Setting).

Step3. Set WiFi according to wifi user manual.

Step4. Operate "Self Test". (applies to Italy only)

➤ Self-test in accordance with CEI 0-21 (applies to Italy only)

The self-test is only required for inverters, which are commissioned in Italy. The Italian standard requires that all inverters feeding into the utility grid are equipped with a self-test function in accordance with CEI 0-21. During the self-test, the inverter will consecutively check the protection reaction times and values for overvoltage, undervoltage, overfrequency and underfrequency.

Selftest function is available at any time, and the test report will show on the LCD display for end-user.

➤ Shut down the inverter :

Step1. Press the "Enter" key for five seconds to enter Off Mode.

Step2. Turn off the AC breaker, EPS breaker and battery breaker.

Step3. Wait 5 min before you open the upper lid.(if in need of repair)

7. Firmware Upgrading

User can upgrade inverter’s firmware via an U-disk.

➤ Preparation

Please ensure the inverter is steadily powered on.
 Inverter must keep the battery on through whole procedure of upgrading.
 Please prepare a PC and make sure the size of U-disk is under 32G, and the format is fat 16 or fat 32.

➤ Upgrading Steps:

Step1. Please contact our service support to get the update files, and extract it into your U-disk as follow:

“update\ARM\618.00050.00_Hybrid_X1G3_Manager_VX.XX_XX-XX.usb”;

“update\DSP\618.00084.00_Hybrid_X1G3_Master_VX.XX_XXXXXXX”;

(Vx.xx is version number, xxxxxxx is file completion date)



Warning!

Make sure the directory is in accordance with above form strictly!
 Do not modify the program file name, or it may cause the inverter not work anymore!

Step2. Press the “Enter” key for 5 seconds to enter Off Mode. Then unscrew the waterproof lid and insert U-disk into the “upgrade” port at the bottom of the inverter.

Step3. The LCD will be shown as picture 3-1. Then press up and down to select the one that you want to upgrade and press “OK” to confirm to upgrade.

Step4. After the upgrade is finished, the LCD will display “succeed”(only for DSP upgrades), please remember to pull off the U-disk, screw the waterproof lid and press the “Esc” to return to the Main interface. Then press the “Enter” key to exit Off Mode.

Step2

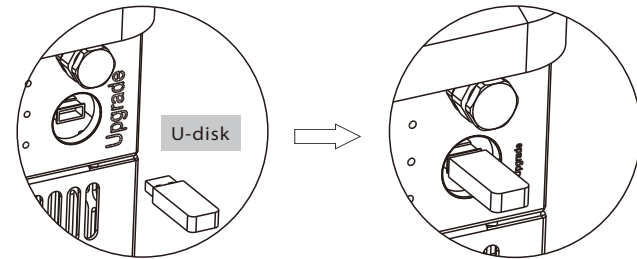

Step3

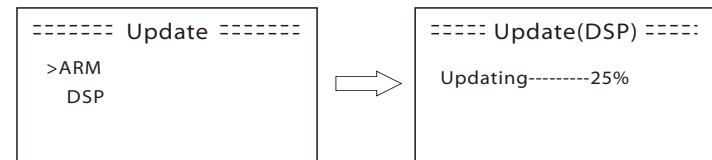

Warning!

If the upgrading is broken off during operation, please ensure the inverter is steadily powered on and reinsert the U-disk.

8. Setting

8.1 Control Panel

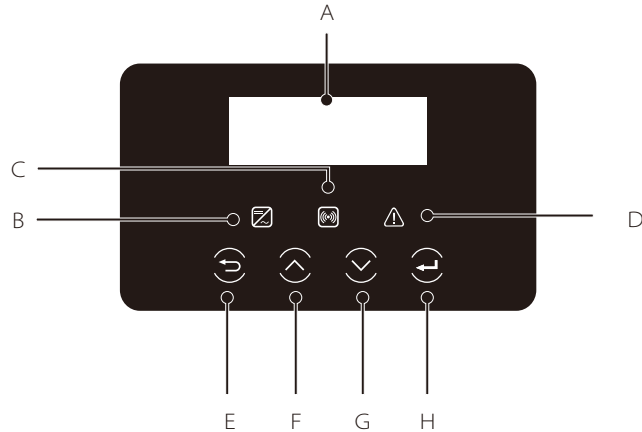

Object	Name	Description
A	LCD Screen	Display the information of the inverter.
B	Indicator LED	lit in blue: The inverter is in normal status or in EPS mode. flash in blue: The inverter is in waiting status. Off: The inverter is in fault status.
C		lit in green: The battery communication is normal. flash in green: The battery is in idle mode. Off: The communication between inverter and battery is failed.
D		lit in red: The inverter is in fault status. Off: The inverter has no errors.
E		ESC button: Return from current interface or function.
F	Function Button	Up button: Move cursor to upside or increase value.
G		Down button: Move cursor to downside or decrease value.
H		OK button: Confirm the selection.

8.2 Menu Structure (maybe changed without notice)

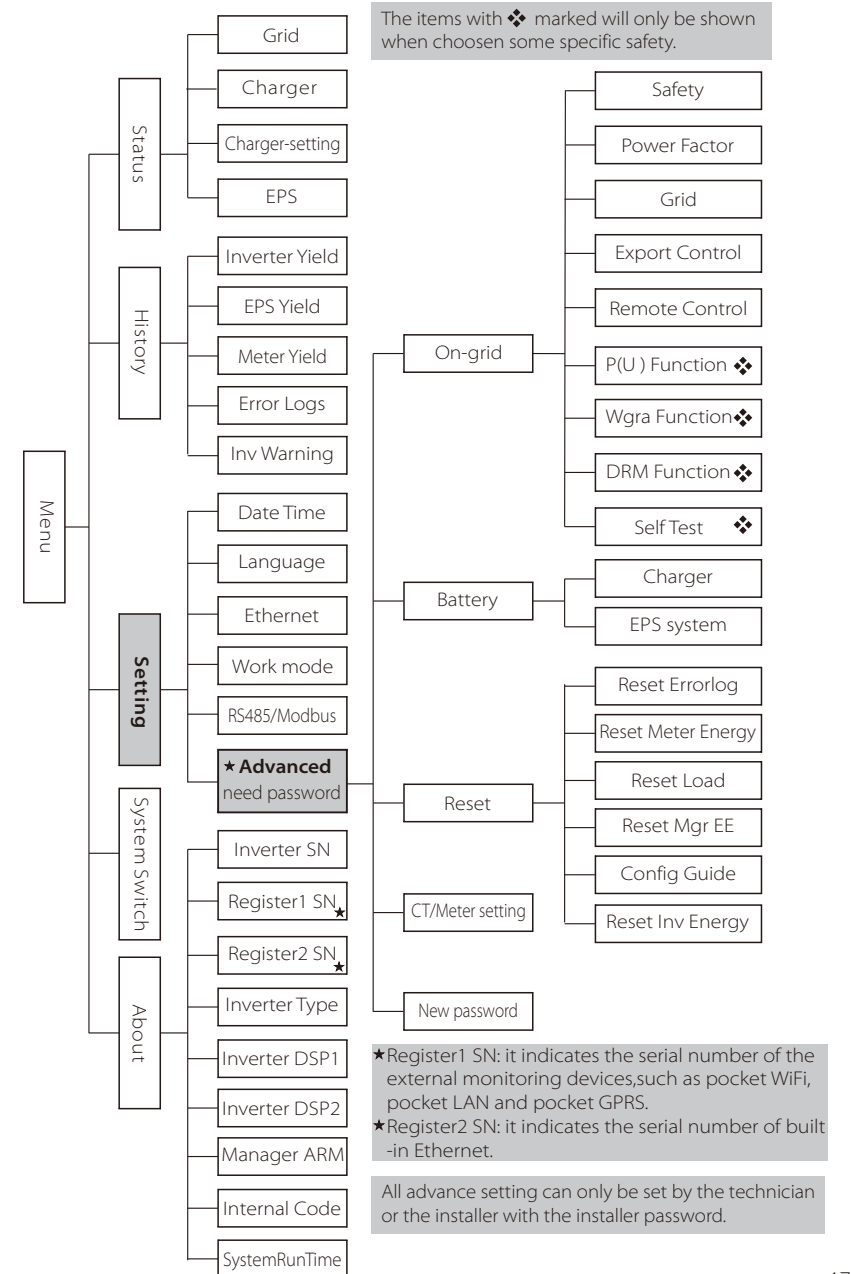

8.3 LCD Operation

LCD Digital Display

The main interface is the default interface, the inverter will automatically jump to this interface when the system started up successfully or not operated for a period of time.

The information of the interface is as below. "Power" means the instant output power; "Today" means the power generated within the day. "Battery" means the left capacity of battery energy.

Power	0W
Today	0.0KWh
Battery	%
Normal	

Menu interface

The menu interface is a transfer interface for user to get into another interface to change the setting or getting the information.

-User can get into this interface by pressing "OK" button when LCD displays the main interface.

-User can select interface by moving the cursor with function button, and press "OK" to confirm.

Menu
Status
History
Settings

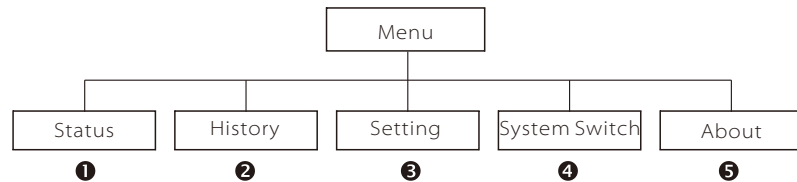

1 Status

The status function contains four items of the inverter: grid, charger, eps and Load. Press up and down to select and press "OK" to confirm the selection, press "ESC" to return to Menu.

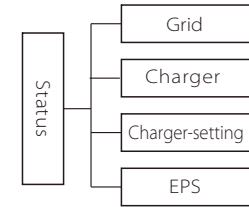

1-1) Grid

This status shows the current grid condition such as voltage, current, output power and the local consumed power.

Pout measures the output of the inverter;

Pgrid measures power export to or import from grid.

Positive value means the energy feeds into grid, negative value means the energy used from the grid.

Grid	
U	000.0V
I	00.0A
P	00.0W

1-2) Charger

This status shows the charger situation of the system. Include the battery voltage, charge or discharge current. Charge or discharge power, battery capacity and battery temperature. "+" means in charging; "-" means in discharging.

Charger	
U	100.0V
I	+1.0A
P	+100W

1-3) Charger setting

This status shows the charger setting values.

User can get the setting values easily here, such as Min capacity, Max charge current, Max discharge current.

Charger Setting	
Min Capacity	20%
MaxChrCut	25A
MaxDischCut	25A

1-4) EPS

EPS will only have data when the inverter is working in EPS mode, it will show the real time data of the EPS output such as voltage, current, power, frequency.

EPS	
U	220V
I	12A
P	2640VA

History

The history function contains five items of the information: Inverter yield, EPS yield, Meter yield ,error logs and inverter warning information. Press up and down to select ,and press "OK" to confirm the selection, press "ESC" to return to Menu.

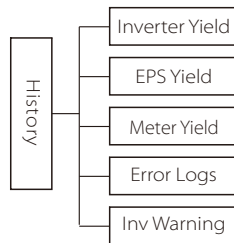

2-1) Inverter Yield

This Inverter Yield contains four items: OutputGridToday, OutputGridTotal, InputGridToday and InputGridTotal.

Inverter Yield	
>OutputGridToday	0.8KWH

2-2) EPS Yield

The EPS Yield function contains EPS yield for today and total.

EPS Yield	
>Today:	0.0KWH

2-3) Meter Yield

The Meter Yield contains four items: FeedInToday, FeedInTotal, ConsumeToday and ConsumeTotal.

Meter Yield	
>FeedInToday:	0.0KWH

2-4) Error Logs

The Error logs record the lastest six error messages happened.

Error logs	
>	No error

2-5) Inv Warning

The Inv warning records inverter warning information here.

Inv Warning	
>	DRM0 OFF

3 Setting

This function is used for setting of the inverter time, connection, battery, grid and so on.
 Enduser can set Date Time, Language, Ethernet ,work mode, RS485/modbus directly.
 But for advance setting, it requires installer password to operate most of the professional settings.

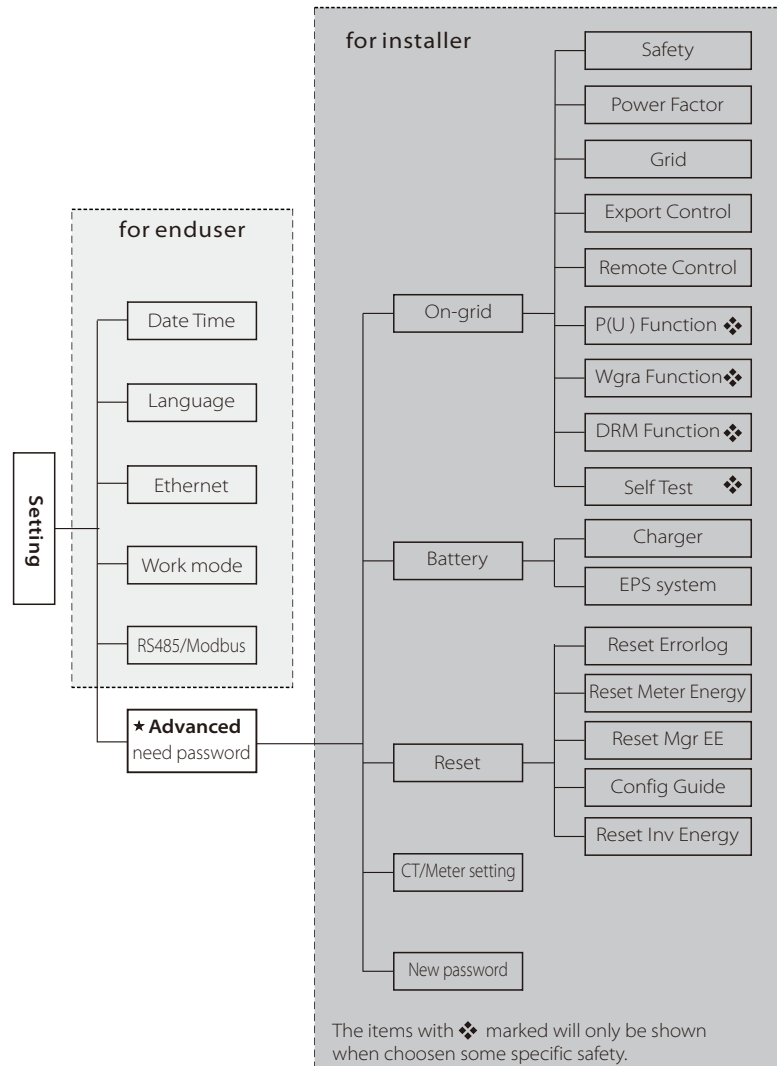

3-1) Date Time

This interface is for user to set the system date and time.

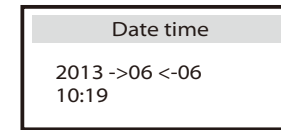

3-2) Language

This inverter provides several languages for customer to select.

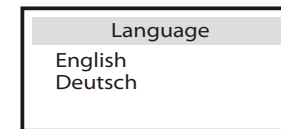

3-3) Ethernet

There are two modes to obtain IP address: static and DHCP.
 User can set the information about ethernet such as IP address, subnet mask number and default gateway number.

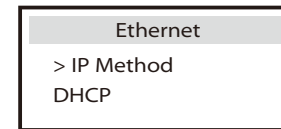

3-4) Work mode

There are 4 work modes for choice.
 All these work modes is available for on-grid condition only:

Parameter	Comment
Self Use (default)	The PV generated power will be used to supply the local loads first, then to charge the battery. The redundant power will export to the public grid. When there is no PV supplied, battery will discharge for local loads first, and grid will supply power when the battery capacity is not enough. The priority of inverter output power is: supplying the load → charging the battery → feeding to the grid
Back Up Mode	Battery will stop discharging to keep higher capacity when the grid is on. when the power generated by PV is not enough, the battery will discharge to supply the local loads too. And if still not enough, the grid will power the local loads together. This work mode applies to the area where suffering from blackout regularly.

Feed in Priority	The priority of inverter output power is: feeding to the grid → supplying the load → charging the battery. This work mode applies to the area with high feed-in tariff.
Force Time Use	In this work mode the charging and discharging time can be set flexibly, and it also allows to choose whether charge from the grid or not. Other time it follows the priority of Self Use mode.

- For "Force Time Use" mode, there are 4 parameters that needs to be set.

Work Mode >Mode Select Force time use	Work Mode >Charger period 1 Charge From Grid	Work Mode > Charge Start time 1 08:00
--	---	---

Parameter
Charger start time1
Charger end time1
Charger start time2
Charger end time2

3-5) RS485/Modbus

X1-Retro fit allow user to obtain inverter data via Rs485 interface. If user chooses this method, user should set baud rate and address here.

RS485/Modbus Baud Rate	115200
----------------------------------	--------

RS485/Modbus RS 485 Addr	1
------------------------------------	---

3-6) Advanced

All the advance setting can be set here, such as battery, grid, EPS and so on. "Advanced" is divided four parts: On-grid, Battery, Reset, User-define. And every part has lower level parts. Please contact with your installer or factory for the installer password to enter.

* Please note that when inverter has DSP communication failed, all the advanced setting will be hidden and invalid expect battery awaken.

Advanced DSP-COMM failed >Battery	Charger >Battery Awaken NO
--	---

The items with ❖ marked will only be shown when chosen some specific safety.

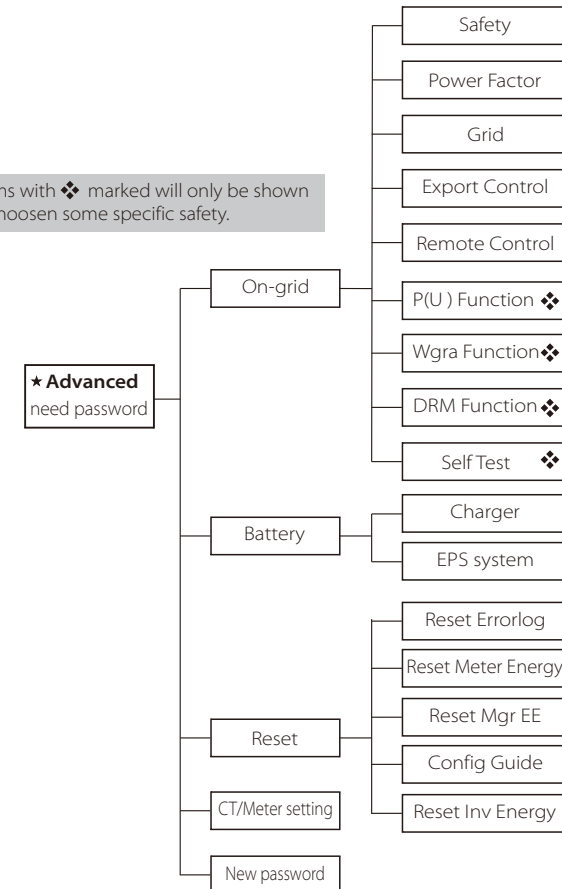

3-6-1-1) safety

User can set safety standard according to different countries and grid tied standards. **(May be changed or added without notice)**

Item	Standard	Country
1	ARN 4015	German
2	AS 4777	Australia
3	G98	UK
4	G99	UK
5	EN 50549	Netherland
6	CEI 0-21	Italy

3-6-1-2) Power Factor (For specific country if required by the local grid.)

There are 5 modes for selecting: Off , Under-Excited, Over-Excited, Curve, Q(u). **(May be changed or added without notice)**

Mode	Comment
Off	-
Under-Excited	PF value
Over-Excited	PF value
Curve	Upper limit
	Lower limit
	Power Upper
	Power Lower
	PFLockInPoint (CEI 0-21 only)
PFLockOutPoint (CEI 0-21 only)	
Q(u)	QuVupRate (EN50438_NL only)
	QuVlowRate (EN50438_NL only)

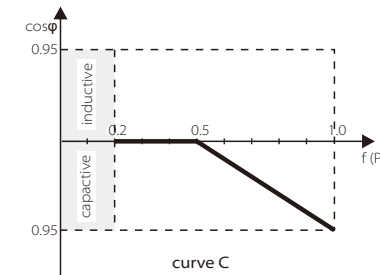
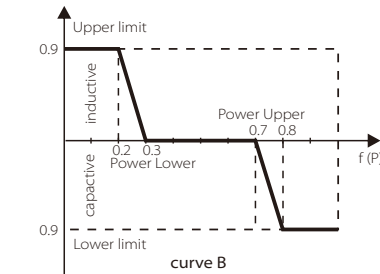
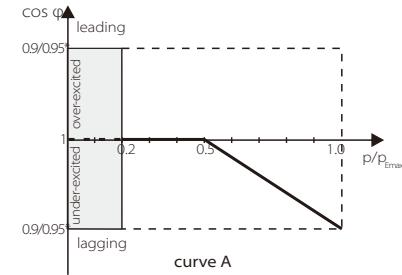

Reactive power control, Reactive standard curve $\cos \phi = f(P)$

For VDE ARN 4105, curve $\cos \phi = f(P)$ should refer to curve A. default value of setting is as shown in curve A.

For E 8001, curve $\cos \phi = f(P)$ should refer to curve B. default value of setting is as shown in curve B.

For CEI 0-21, default value of PFLockInPoint is 1.05, when $V_{ac} > 1.05V_n$, and $P_{ac} > 0.2 P_n$, curve $\cos \phi = f(P)$ should refer to curve C. Default value of PFLockOutPoint is 1 when $V_{ac} < 1 V_n$, $\cos \phi = f(P)$ will exit curve C.

Reactive power control, Reactive standard curve $Q = f(V)$

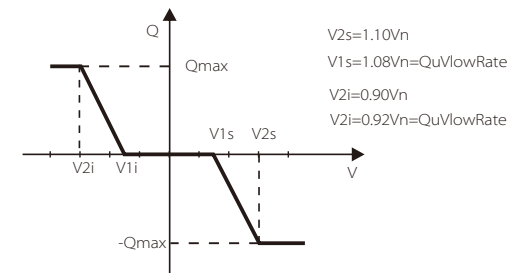

3-6-1-3) Grid

The enduser do not need to set the grid parameters. All default value has set on factory according to safety rules.

If need to reset, any changes should according to the requirement of local grid.

Parameter	Comment
Normally	
Vac upper	Voltage high protect
Vac lower	Voltage low protect
Vac upper slow	Voltage high slow protect
Vac lower slow	Voltage low slow protect
Fac upper	Frequency high protect
Fac lower	Frequency low protect
Fac upper slow	Frequency high slow protect
Fac lower slow	Frequency low slow protect
Vac 10m avg	10 min voltage high protect
Apply to Italy(CEI0-21) only.	
Tuvp_Fast	Overvoltage protect fast time
Tovp_Fast	Undervoltage protect fast time
Tufp_Fast	Overfrequency protect fast time
Tofp_Fast	Underfrequency protect fast time
Tuvp_Slow	Overvoltage protect slow time
Tovp_Slow	Undervoltage protect slow time
Tufp_Slow	Overfrequency protect slow time
Tofp_Slow	Underfrequency protect slow time
FreDrpDlyTime	Frequency droop delay time
Apply to EN50438_NL only.	
FreqSetPoint	Frequency set point
FreqDropRate	Frequency droop rate
Apply to EN50549_EU only.	
T-Start	Chacking time set
FreqDropRate	Frequency droop rate
UFPL_StartPiont	Under Frequency power limit start point
UFPL_Startting	Under Frequency power limit switch set
OFPL_Startting	Over Frequency power limit switch set

3-6-1-4) Export control

This function allows the inverter able to control energy. There are user value and factory value. The factory value is default which can not be changed by user. The user value setting by installer must be less than the factory value.

Choose "Disable" means the function will be shut off.

The meaning of the set number is the max. output power allowed. If the user do not want feed any power into grid, please set it to 0.



3-6-1-5) Remote Control

Remote control function allows external control device to make the inverters remote cluster control through LAN port on the inverter. And it can control the inverter's active power output and reactive power output.

The default value is "enable". Choose "disable" means the function is turn off.

If this function is used, the current work mode will be invalid.

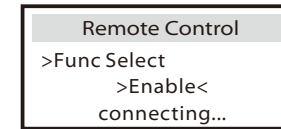

3-6-1-6) P(u) Function(applies to NZS4777.2)

P(U) function is Volt-watt response mode which is required by standard NZS4777.2 .and applies to NZS4777.2 only.

The default value is "enable". Choose "disable" means the funciton is turn off.

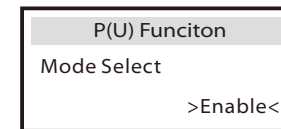

3-6-1-7) W(Gra) Function(applies to NZS4777.2)

W(Gra) is Gradient of power rate limit which is required by standard NZS4777.2 .and applies to NZS4777.2 only. This function is defined as a percentage of rated power per minute.

The default value is "enable". Choose "disable" means the funciton is turn off.

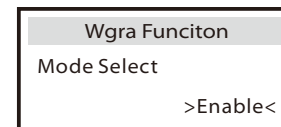

3-6-1-8) DRM Function(applies to NZS4777.2)

DRM function is Demand Response Mode which is required by standard NZS4777.2 .and applies to NZS4777..2 only.

The default value is "enable". Choose "disable" means the funciton is turn off.

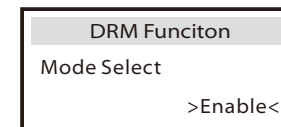

3-6-1-9)Self Test (applies to CEI 0-21 only)

The self test function allows user to test the following items"ALL test", "Ovp(59.S2) test", "Uvp(27.S1) test", "Uvp(27.S2) test", "Ofp(81>.S1) test", "Ufp(81<.S1) test", "Ofp(81>.S2) test", "Ufp(81<.S2) test", "Ovp10(59.S1) test".

In the self test interface, user can test choose "ALL test" or individual test item. Please make sure the inverter is grid-tied before testing test. For all test, it needs about 6 minutes. And it will display "success" then "Pass" on the display. For individual test item, it needs about several seconds or minutes. Click test report to obtain all items test result.

<p style="text-align: center;">Self Test</p> <p>ALL Test Test report Uvp(27.S1) test</p>	
<p>>Ofp2(81>.S2)result Ft: 51.50Hz Tt:1000ms Fs: 0.00Hz To: 998ms F0: 0.00Hz pass</p>	<p>>Ovp2(59.S2)result Vt: 264.5V Tt: 300ms Vs: 0.0V To: 200ms V0: 0.0V pass</p>
<p>>Ofp2(27.S2)result Vt: 92.0V Tt:200ms Vs: 0.0V To: 196ms V0: 0.2V pass</p>	<p>>Uvp2(27.S1)result Vt: 195.5V Tt: 400ms Vs: 0.0V To: 200ms V0: 0.0V pass</p>
<p>>Ofp2(81>.S1)result Ft: 50.50Hz Tt: 100ms Fs: 0.00Hz To: 96ms F0: 0.2Hz pass</p>	<p>>Ufp2(81<.S1)result Ft: 49.50Hz Tt: 100ms Fs: 0.00Hz To: 98ms F0: 0.02Hz pass</p>
<p>>Ufp2(81<.S2)result Ft: 47.50Hz Tt:400ms Fs: 0.00Hz To: 3999ms F0: 0.02Hz pass</p>	<p>>Ovp10(59.S1)result Vt: 253.0V Tt:600ms Vs: 0.0V To: 598ms V0: 0.0V pass</p>

3-6-2-1) Charger

Here the user can set the parameters of charger on this page. Users can set the charge & discharge parameters, min capacity and awaken function. For the detailed parameters, please refer to below table.

 **NOTE !**

- Please confirm the Inverter setting for maximum charge/discharge current is within the range of battery rated charge/discharge current.

 **NOTE!**

- If user wants to use lead acid battery, please contact SOLAX for future reference.

<p style="text-align: center;">Charger</p> <p>>Min Capacity 20%</p>	<p style="text-align: center;">Charger</p> <p>Charge Max Current 25A</p>	<p style="text-align: center;">Charger</p> <p>Discharge Max Current 25A</p>
<p style="text-align: center;">Charger</p> <p>>Battery Awaken NO</p>	<p style="text-align: center;">Charger</p> <p>>Grid-tied Min Limit</p>	

Parameter	Comment
Min capacity *	The remaining minimum capacity of the battery.
Charge Max Current	The charge current can be set for 0-30A.
Discharge Max Current	The discharge current can be set for 0-30A.
Battery Awaken	When the battery voltage drops too low to work, choose this option "Yes" to make battery charging from PV or grid forcibly.
Grid-tied Min Limit	The remaining minimum capacity of the battery when grid is on.

➤ Min capacity

When the battery capacity reaches the min capacity in **on-grid** mode(no PV power), battery will stop discharging and the system will go into IDLE mode.

When the battery capacity reaches the min capacity in **off-grid** mode, battery will stop discharging and the inverter will stop exporting power from EPS port with showing "BAT power low" on LCD display.

There are two ways to exit from "BAT power low".

-Press ESC button can exit from "BAT power low" manually.

-Enter EPS system setting page(refer to 3-6-2-2 section) to exit from "BAT power low" automatically.

➤ Grid-tied Min Limit

If user want to distinguish min capacity between on-grid mode and off-grid mode and reserve some capacity specially for off-grid usage, user can enable this function.
 -Enter Grid-tied Min Limit interface, choose this funtion "enable", then set "Min capacity".

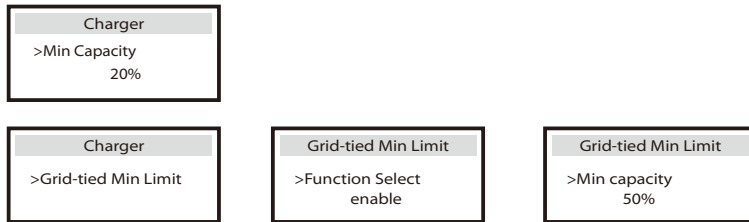

For example:
 If user set charger- Min capacity "20%", and set grid-tied min limit-min capacity "50%":
 When the battery capacity reaches 50% when grid is on, the battery will stop discharging. When grid is off, the battery can continues to discharge the load to 20% capacity.

➤ Battery awaken

-When the battery is very low and stop working, user can restart the battery manually by choosing this functin "YES".
 Inverter will charge the battery when the PV input power > 1KW or inverter is connected to the grid.
 Inverter will exit the Battery Awaken when battery voltage > discharge cut-off voltage + 10V or Battery Awaken last > 2 hours.
 -When inverter is in normal operation, and the battery power is sufficient, start the Battery Awaken function, the inverter will exit the Battery Awaken automatically.

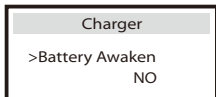

3-6-2-2) EPS system (For I/E Version only)

X1-Retro fit inverter with I/E Version can work on the EPS mode.

EPS parameters can be set as below.

"Mute" means you can set the warning of system which has entered EPS mode.

- "No" means there will be a buzzing and it is the default value.

- "Yes" means you choose to shut down the warning function.

Besides ,if the buzzing is sharp, it means EPS output is "over loads."

Frequency "here can be set 50Hz or 60Hz please based on correlative loads.

➤ EPS auto restart

"EPS auto restart" is used for restarting EPS output power manually or automatically.

When the battery capacity reaches to min capacity or battery voltage reaches discharge cut voltage in off-grid mode, battery will stop discharging and the inverter will stop exporting power from eps port with showing "BAT power low" on LCD display.

- Choose "disable" means the EPS output power can only be restarted by pressing ESC button manually and it is the default value.

- Choose "enable" means the EPS output power can be restarted automatically through setting the "Min ESC Soc".

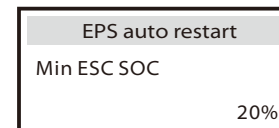
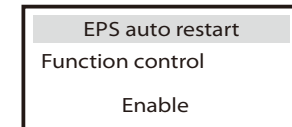
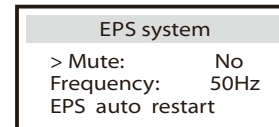

3-6-3-1) Reset Errorlog

User can reset all inverter errorlog record here.

Reset Errorlog	
Reset	>No<

3-6-3-2) Reset Meter Energy

User can reset the meter energy record here.

Reset Met Energy	
>Reset Meter1	No

3-6-3-3) Reset MgrEE

User can reset MgrEE here.

Reset MgrEE	
>Reset MgrEE	No

3-6-3-4) Config guide

This interface will trigger the initial setting guide re-play again.

Config Guide	
>Start	

3-6-3-5) Reset Inv energy

User can reset all inverter errorlog record here.

Reset Inv Energy	
>Reset	NO

3-6-4) CT/Meter Setting

X1-Retro fit inverter need to work with Energy meter to achieve hybrid functions. In hybrid system, if there is other power device in the system which is also wanted to be monitored, It can install two meters to monitor both solax inverter and other power device. These two meters need to be set different to address. Address 001 and address 002 are default and will be written to meters in factory. So user do not need to change the address except specific situation.

MeterSetting	MeterSetting	MeterSetting
>MeterFunction	>Meter1Addr	>Meter2Addr
Enable	1	2



NOTE!

- X1-Retro fit inverter can not work with a current sensor(CT) directly.
- X1-Retro fit inverter should keep the meter function"enable" all the time. (meterfunction-disable is for other SOLAX hybrid inverter")

3-6-5) New Password

User can set the new password here.

4 System Switch

"System Switch" can be selected from "ON" or "OFF".
 "ON" means the inverter is on working condition and it is inverter default status.
 "OFF" means the inverter stop delivering all power, but the LCD remains on.

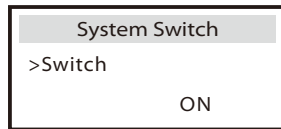

Long press "Enter" key can also switch on "System Switch" "ON" or "OFF".

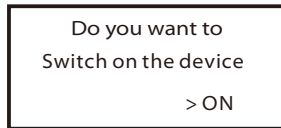

5 About

This interface shows information of the inverter including inverter serial number, Register1 serial number, Register2 serial number, inverter type, master DSP1, manager ARM, internal code and battery version information.

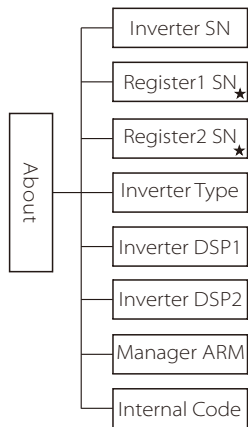

★ Register1 SN: it indicates the serial number of the external monitoring devices, such as pocket WiFi, pocket LAN and pocket GPRS.
 ★ Register2 SN: it indicates the serial number of built-in Ethernet.

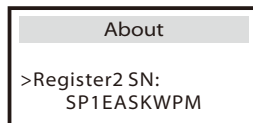
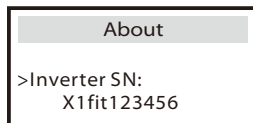

9. Troubleshooting

9.1 Trouble shooting(maybe updated without notice)

This section contains information and procedures for solving possible problems with X1-Retro Fit inverters, and provides you with troubleshooting tips to identify and solve most problems that could occur with the X1-Retro Fit inverters. This section will help you narrow down the source of any problems you may encounter. Please read the following troubleshooting steps. Check warnings or fault messages on System Control Panel or Fault codes on the inverter information panel. If a message is displayed, record it before doing anything further. Attempt the solution indicated in below table.

Faults	Diagnosis and solution
AC10M Volt Fault	The grid voltage is out of range for the last 10 Minutes. • The system will back to normal if the grid is back. • Or seek for help from us.
AC HCT Fault	AC Current Sensor Fault • Turn off the PV, battery and grid , reconnect them. • Or seek help from us, if can not go back to normal state.
BatConDir Fault	Battery Reverse Connection Fault • Check if the positive pole and negative pole of battery are connected in a contrary way • Or seek help from us.
Bat Volt Fault	Battery Voltage Fault • Check if the battery input voltage.is within the normal range • Or seek help from us.
BMS_CellImblance	Battery Fault-cell imbalance fault • Please contact battery supplier.
BMS_ChargeOCP	Battery Fault-charge overcurrent fault • Please contact battery supplier.
BMS_DischargeOCP	Battery Fault-discharge overcurrent fault • Please contact battery supplier.

Faults	Diagnosis and solution
BMS_External_Err	Battery Fault-external fault • Please contact battery supplier.
Bus Volt Fault	Bus Voltage Out of Normal Range • Disconnect PV+ , PV- and battery, reconnect them. • Check if the PV input is within the range of the inverter. • Or seek help from us, if can not go back to normal state.
BMS_Internal_Err	Battery Fault-internal fault • Please contact battery supplier.
BMS Lost	BMS Communication Lost • Check if the BMS cable is loose or broken. • Or seek help from us, if can not go back to normal state.
BMS_LowerVoltage	Battery Fault-undervoltage fault • Please contact battery supplier.
BMS_OverVoltage	Battery Fault-overvoltage fault • Please contact battery supplier.
BMS_TemHigh	Battery Fault-over-temperature fault • Please contact battery supplier.
BMS_TemLow	Battery Fault-under-temperature fault • Please contact battery supplier.
EPS Relay Fault	EPS Relay Fault • Disconnect PV+ , PV- , grid and battery, reconnect them. • Or seek help from us, if can not go back to normal state.
EPS OCP Fault	Over Current in EPS Mode. • Make sure the load power is within the EPS power range. • Check if any nonlinear load is connect on the EPS. Remove this load to check if can recover. • Or seek help from us, if can not go back to normal state.
Fan Fault	Fan Fault • Turn off the PV, battery and grid , reconnect them. • Or seek help from us, if can not go back to normal state.
Grid Freq Fault	Grid Frequency Out of Range • System will reconnect if the utility is back to normal. • Or seek help from us.
Grid Lost Fault	Grid is Lost. • Please wait for a while and system will reconnect if the utility is back to normal. • Please check whether the cable connection at AC side is normal or not. • Or seek help from us.

Faults	Diagnosis and solution
Grid Relay Fault	EPS Relay Fault • Disconnect PV+ , PV- , grid and battery, reconnect them. • Or seek help from us, if can not go back to normal state.
Grid Volt Fault	Grid Voltage Out of Range • Please wait for a while and system will reconnect if the utility is back to normal. • Please check whether the grid voltage is in the normal range. • Or seek help from us.
Input Cnf Fault	PV Panel connection abnormal • Check if two MPPTs connect in a parallel mode. Please connect the two MPPTs independently. • Or seek help from us, if can not go back to normal state.
Inter Com Fault	Internal Communication Fault • Turn off the PV, battery and grid , reconnect them. • Or seek help from us, if can not go back to normal state.
Inv EEPROM Fault	Inverter EEPROM Fault • Turn off the PV, battery and grid , reconnect them. • Or seek help from us, if can not go back to normal state.
Isolation Fault	Isolation Fault • Please check if the insulation of electric wires are damaged. • Wait for a while to check if back to normal. • Or seek for help from us.
Meter Fault	Meter Fault. • Please check if the meter is in normal working. • Or seek for help from us if can not back to normal.
Mgr EEPROM Fault	Manager EEPROM Fault. • Turn off the PV, battery and grid , reconnect them. • Or seek for help from us if can not back to normal.
OtherDevideFault	Other Devide Fault • Disconnect PV+ , PV- , grid and battery, reconnect them. • Or seek help from us, if can not go back to normal state.
OverLoad Fault	Over Load in EPS Mode. • Turn off high power device , press"ESC" to restart the inverter. • Or seek help from us, if can not go back to normal state.
PV Volt Fault	PV Voltage Out of Range • Check the output voltage of the PV panels. • Or seek for help from us.
RCD Fault	Residual Current Device Fault • Check the impedance of DC input and AC output. • Disconnect PV+ , PV- and battery, reconnect them. • Or seek help from us, if can not go back to normal state.

Faults	Diagnosis and solution
RC OCP Fault	DCI over current protection Fault. <ul style="list-style-type: none"> • Please check if the insulation of electric wires are damaged. • Wait for a while to check if back to normal. • Or seek for help from us.
Sample Fault	The detection circuit Fault <ul style="list-style-type: none"> • Disconnect PV+ , PV- and battery, reconnect them. • Or seek help from us.
SW OCP Fault	Over current fault detected by software. <ul style="list-style-type: none"> • Wait for a while to check if back to normal. • Turn off the PV, battery and grid , reconnect them. • Or seek for help from us.
Temp Over Fault	Temperature over the limitation <ul style="list-style-type: none"> • Check if the environment temperature is over limitation. • Or seek help from us.
TZ Protect Fault	Over current Fault. <ul style="list-style-type: none"> • Wait for a while to check if go back to normal status. • Disconnect PV+ , PV- and battery, reconnect them. • Or seek help from us, if can not go back to normal state.

- If your inverter's information panel is not displaying a Fault light, check the following list to make sure that the present state of the installation allows proper operation of the unit.
 - Is the inverter located in a clean, dry, adequately ventilated place?
 - Are the cables adequately sized and short enough?
 - Are the input and output connections and wiring in good condition?
 - Are the configurations settings correct for your particular installation?
 - Are the display panel and the communications cable properly connected and undamaged?

Contact SolaX Customer Service for further assistance. Please be prepared to describe details of your system installation and provide model and serial number of the unit.

9.2 Routine maintenance

Inverters do not need any maintenance or correction in most condition, but if the inverter often loses power due to overheating, this can be the following reason:

- The cooling fins on the rear of house are covered by dirt. Clean the cooling fins with a soft dry cloth or brush if necessary.

Only trained and authorized professional personnel who are familiar with the requirements of safety was allowed to perform servicing and maintenance work.

➤ Safety checks

Safety checks should be performed at least every 12 months, please contact manufacturer to arrange qualified person who has adequate training, knowledge, and practical experience to perform these tests. (Please kindly note this action is not covered by warranty). The data should be recorded in an equipment log. If the device is not functioning properly or fails any of test, the device has to be repaired. For safety check details, refer to this manual, section 2 Safety instruction and EC Directives.

➤ Maintain Periodically

Only qualified person may perform the following works.

During the process of using the inverter, the manager shall examine and maintain the machine regularly. The concrete operations are follow.

- 1: Check that if the cooling fins on the rear of house are covered by dirt, and the machine should be cleaned and absorbed dust when necessary. This work shall be check time to time.
- 2: Check that if the indicators of the inverter are in normal state, check if the keys of the inverter are in normal state, check if the display of the inverter is normal. This check should be performed at least every 6 months.
- 3: Check that if the input and output wires are damaged or aged. This check should be performed at least every 6 months.
- 4: You should keep the inverter panels clean and their security checked at least every 6 months.

10. Decommissioning

10.1 Remove the Inverter

- Disconnect the inverter from AC output.
- Wait for 5 minutes for de-energizing.
- Disconnect communication and optional connection wirings.
- Remove the inverter from the bracket.
- Remove the bracket if necessary.

10.2 Packaging

Please pack the inverter with the original packaging.

If the original package is no longer available, you can also use an equivalent carton that meets the following requirements.

- Suitable for loads more than 30 kg.
- With handle.
- Can be fully closed.

10.3 Storage and Transportation

Store the inverter in a dry environment where ambient temperature keep always between -20 °C - +60 °C. Take care of the inverter during the storage and transportation,keep less than 4 cartons in one stack.

When the inverter or other related components need to be disposed. Have it carried out according to local waste handling regulations. Please be sure to deliver wasted inverters and packing materials to certain site, where can assist relevant department to dispose and recycle.