



X-Hybrid Series User Manual



EN

Copyright Declaration

The copyright of this manual belongs to SolaX Power Co., Ltd. . Any corporation or individual should not plagiarize, partially copy or fully copy it (including software, etc.), and no reproduction or distribution of it in any form or by any means. All rights reserved. SolaX Power Co., Ltd. reserves the right of final interpretation. This information is subject to changes without notice.

Contents

1 NOTES ON THIS MANUAL	03
1.1 SCOPE OF VALIDITY	03
1.2 TARGET GROUP	03
1.3 SYMBOLS USED	03
2 SAFETY	04
2.1 APPROPRIATE USAGE	04
2.2 IMPORTANT SAFETY INSTRUCTIONS	05
2.3 EXPLANATION OF SYMBOLS	06
2.4 EC DIRECTIVES	09
3 INTRODUCTION	10
3.1 BASIC FEATURE AND DIFFERENT WORKING MODES	10
3.2 TERMINALS OF X-HYBRID READY INVERTER, HYBRID INVERTER AND BMU	10
3.3 DIMENSION	12
3.4 IDENTIFICATION OF X-HYBRID	13
4 TECHNICAL DATA FOR X-HYBRID INVERTER	13
4.1 DC INPUT	13
4.2 AC OUTPUT	14
4.3 EPS OUTPUT WITH INTERNAL CHARGER(E VERSION FOR SK-SU)	14
4.4 EFFICIENCY, SAFETY AND PROTECTION	15
4.5 INTERNAL CHARGER (FOR SK-SU).....	15
4.6 GENERAL DATA	16
5 TECHNICAL DATA FOR X-HYBRID BMU	16
5.1 ELECTRICAL DATA	16
5.2 GENERAL DATA	17
6 INSTALLATION	17
6.1 UN PACKING	17
6.2 CHECK FOR TRANSPORT DAMAGE	19
6.3 INSTALLATION PRECAUTION	19
6.4 PREPARATION	21
6.5 INSTALLATION STEPS	22
6.6 CONNECTIONS OF X-HYBRID SYSTEM	23
6.6.1 THE MAIN STEPS TO CONNECT THE X-HYBRID SYSTEM	23



6.6.2 COMMUNICATION INTERFACE	34
6.7 INVERTER MANIPULATION	35
7 OPERATION METHOD	36
7.1 CONTROL PANEL	36
7.2 LCD FUNCTION	37
7.3 LCD OPERATION	38
8 TROUBLESHOOTING	48
8.1 TROUBLE SHOOTING	48
8.2 ROUTINE MAINTENANCE	52
9 DECOMMISSIONING	53
9.1 DISMANTLING THE INVERTER	53
9.2 PACKAGING	53
9.3 STORAGE	53
9.4 DISPOSAL	53

1 Notes on This Manual

1.1 Scope of Validity

This manual is an integral part of inverter, and it describes the assembly, installation, commissioning, maintenance and failure search of the below inverters. Please read it carefully before operating.

SK-TL3000	SK-TL3700	SK-TL5000
SK-SU3000	SK-SU3700	SK-SU5000
SK-BMU1300	SK-BMU2500	SK-BMU5000

The X-hybrid has E version and C version.

The C version is provided with suffix "C" and is mainly for city solution, without EPS function. All model number of the C version inverter will be provided with suffix "C".

The E version is mainly for country solution, with EPS function.

Store this manual where it will be accessible at all times.

1.2 Target Group

This manual is for qualified electricians. The tasks described in this manual only can be performed by qualified electricians.

1.3 Symbols Used

The following types of safety instructions and general information appear in this document as described below:



DANGER !

"Danger" indicates a hazardous situation which, if not avoided, will result in death or serious injury.



WARNING !

"Warning" indicates a hazardous situation which, if not avoided, could result in death or serious injury.



CAUTION !

"Caution" indicates a hazardous situation which, if not avoided, could result in minor or moderate injury.



NOTE !

"Note" provides tips that are valuable for the optimal operation of your product.

2 Safety

2.1 Appropriate Usage

The X-hybrid includes :

- Hybrid ready inverter SK-TL which can convert the DC current of the PV generator into AC current for on grid or off grid usage.
- Hybrid inverter SK-SU, which can store the energy in the battery for self-use and also can convert the DC current of the PV generator into AC current for on grid or off grid usage.
- Hybrid battery management unit (BMU), which can work together with the SK-TL to implement a battery storage system.
- X-hybrid E version with EPS can supply the energy from battery and PV generator when the grid is lost.

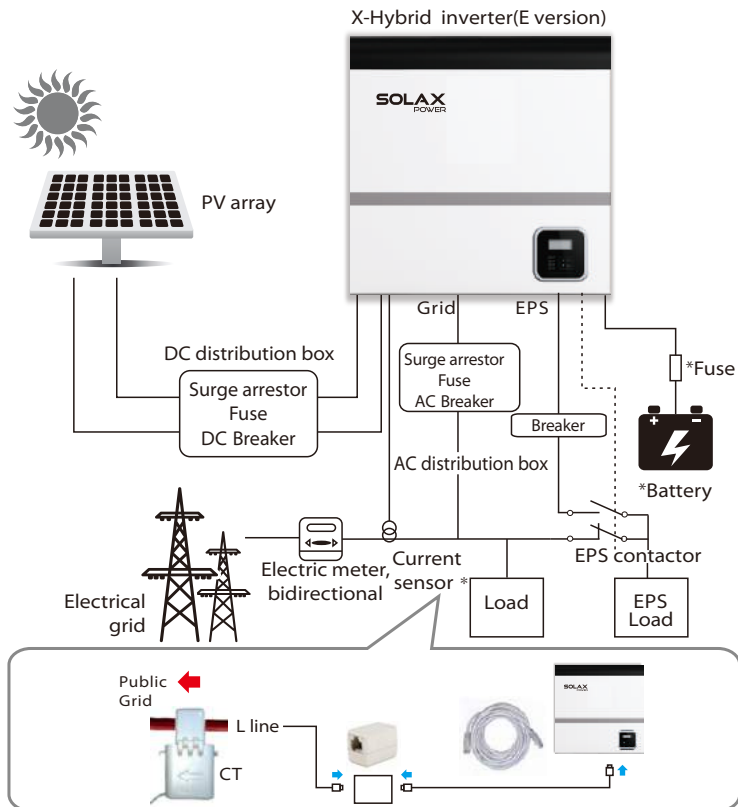

- Note:
- * For SK-TL series , the fuse and battery are not used
 - * The CT can be replaced with meter if necessary.
 - * The EPS function is only for E version

Surge protection devices (SPDs) for PV installation



WARNING !

Over-voltage protection with surge arresters should be provided when the PV power system installed.
The grid connected inverter is not fitted with SPDs in both PV input side and MAINS side.

Lighting can cause damage either from direct strike or from surges due to a nearby strike.

Induced surges are the more likely cause of lighting damage in majority of installations, especially in rural areas where electricity is usually by long overhead lines. Surge may be included on both the PV array conduction and the a.c. cables leading to the building.

Specialists in lightning protection should be consulted during the end use application. Using appropriate external lightning protection, the effect of a direct lightning strike into a building can be mitigated in a controlled way, and the lightning current can be discharged into the ground.

Installation of SPDs to protect the inverter against mechanical damage and excessive stress include a surge arrester in case of a building with external lightning protection system (LPS) when separation distance is kept.

To protect the d.c. system, surge suppression device (SPD type2) should be fitted at the inverter end of the d.c. cabling and at the array, located between the inverter and the PV generator, if the voltage protection level (VP) of the surge arresters is greater than 1100V, a additional SPD type 3 required for surge protection for electrical devices.

To protect the a.c system, surge suppression devices (SPD type2) should be fitted at the main incoming point of a.c supply (at the consumer's cutout), located between the inverter and the meter/distribution system; SPD (test impulse D1) for signal line according to EN 61632-1.

All d.c cables should be installed to provide as short runs as possible, and positive and negative cables of the same string or main d.c supply should be bundled together. Avoiding the creation of loops in the system. This requirement for short runs and bundling includes any associated earth/bundling conductors.

Spark gap devices are not suitable to be used in d.c circuits as once conducting, they won't stop conducting until the voltage across their terminals is typically more than 30 volts.

2.2 Important Safety Instructions



DANGER !

DANGER TO LIFE DUE TO HIGH VOLTAGES IN THE INVERTER !

- All work on the inverter must be carried out by qualified electrician.
- The appliance is not to be used by children or persons with reduced physical sensory or mental capabilities, or lack of experience and knowledge, unless they have been given supervision or instruction.
- Children should be supervised to ensure that they do not play with the appliance.

CAUTION !
DANGER OF BURN INJURIES DUE TO HOT ENCLOSURE PARTS !
 During operation, the upper lid of the enclosure and the enclosure body may become hot.
 • Only touch the lower enclosure lid during operation.





CAUTION !
POSSIBLE DAMAGE TO HEALTH AS A RESULT OF THE EFFECTS OF RADIATION !
 • Do not stay closer than 20 cm to the inverter for any length of time.

NOTE !
 Grounding the PV generator.
 Comply with the local requirements for grounding the PV modules and the PV generator. SolaX recommends connecting the generator frame and other electrically conductive surfaces in a manner which ensures continuous conduction and ground these in order to have optimal protection of the system and persons.

2.3 Explanation of Symbols











This section gives an explanation of all the symbols shown on the inverter and on the type label.

• Symbols on the Inverter

Symbol	Explanation
	Operating Display.
	The battery is in charging or discharging.
	Communication is active.
	An error has occurred, please inform your installer immediately.

• Symbols on the Type Label

Symbol	Explanation
	CE mark. The inverter complies with the requirements of the applicable CE guidelines.

	TUV certified.
	RCM remark.
	SAA certification.
	Beware of hot surface. The inverter can become hot during operation. Avoid contact during operation.
	Danger of high voltages. Danger to life due to high voltages in the inverter!
	Danger. Risk of electric shock!
	Observe enclosed documentation.
	The inverter can not be disposed of together with the household waste. Disposal information can be found in the enclosed documentation.
	Don't work on this inverter until it is isolated from battery, mains and on-site PV generation suppliers.
	Danger to life due to high voltage. There is residual voltage in the inverter which needs 5 min to discharge. • Wait 5 min before you open the upper lid or the DC lid.

• **Important Safety Instructions**

When using the product, please do remember the below information to avoid the fire, lightning or other personal injury:



WARNING !
Ensure input DC voltage \leq Max. DC voltage . Over voltage may cause permanent damage to inverter or other losses, which will not be included in warranty! This chapter contains important safety and operating instructions. Read and keep this Operation Guide for future reference.



WARNING !
Authorized service personnel must disconnect both AC and DC power from the X-hybrid inverter before attempting any maintenance or cleaning or working on any circuits connected to the X-hybrid inverter.

- Read all instructions, cautionary markings on the inverter, and all appropriate sections of this manual before using this inverter.

- Use only attachments recommended or sold by SolaX.
- Make sure that existing wiring is in good condition and that wire is not undersized. Do not operate the X-Hybrid Series inverter with damaged or substandard wiring.
- Do not disassemble the X-Hybrid Series inverter. It contains no user-serviceable parts. See Warranty for instructions on obtaining service. Attempting to service the X-Hybrid Series inverter yourself may result in a risk of electric shock or fire and will void your warranty.
- Keep away from flammable, explosive materials to avoid fire disaster.
- The installation place should be away from humid or corrosive substance.
- Authorized service personnel must use insulated tools when installing or working with this equipment.
- PV modules shall have an IEC 61730 class A rating.

● PE Connection and Leakage Current

- The end-use application shall monitoring of the protective conductor by residual current operated protective device (RCD) with rated fault current $I_{fn} \leq 240\text{mA}$ which automatically disconnects the device in case of a fault.
- DC differential currents are created (caused by insulation resistance and through capacities of the PV generator). In order to prevent unwanted triggering during operation, the rated residual current of the RCD has to be min 240mA. The device is intended to connect to a PV generator with a capacitance limit of approx 700nf.



WARNING !

High leakage current!
Earth connection essential before connecting supply.

- Incorrect grounding can cause physical injury, death or equipment malfunction and increase electromagnetic.
- Make sure that grounding conductor is adequately sized as required by safety regulations.
- Do not connect the ground terminals of the unit in series in case of a multiple installation. This product can cause current with a d.c component, Where a residual current operated protective (RCD) or monitoring (RCM) device is used for protection in case of direct or indirect contact, only an RCD or RCM of type B is allowed on the supply side of this product.
- For Australia and New Zealand:
The installation of inverter must fulfill Australia national Wiring rules AS/NZS3000, AS/NZS4777.1 and AS/NZS5033.



WARNING !

Do not work on the inverter when the device is running.

- Never touch either the positive or negative pole of PV or battery connecting device. And never ever touch both at the same time.



WARNING !

Risk of electric shock!

- The unit contains capacitors that remain charged to a potentially lethal voltage after the MAINS , battery and PV supply has been disconnected.
- Hazardous voltage will present for up to 5 minutes after disconnection from power supply.
- CAUTION-RISK of electric shock from energy stored in capacitor, never work on the solar inverter couplers. The MAINS cable, Battery cable, PV cables or the PV generator when power is applied. After switching off the PV , battery and Mains, always wait for 5minutes to let the intermediate circuit capacitors discharge before you unplug DC ,battery inplug and MAINS couplers.
- When access to internal circuit of solar inverter, it is very important to wait 45 minutes before working on power circuit or demounting the electrolyte capacitors inside the device. Do not open the device before hand since the capacitors require this long to discharge sufficiently!
- Measure the voltage between terminals UDC+ and UDC- with a multi-meter (impedance at least 1Mohm) to ensure that the device is discharged before beginning work (35VDC) inside the device.

2.4 EC Directives

This chapter follows the requirements of the European low voltage Directives, which contains the safety instructions and conditions of acceptability for the endues system, which you must follow when installing, operating and servicing the unit. If ignored, physical injury or death may follow, or damage may occur to the unit. Read this instructions before you work on the unit. If you are unable to understand the dangers, warnings, cautions or instructions, contact the manufacturer if an authorized service dealer before installing. Operating and servicing the unit.

The X-Hybrid inverter meets the requirement stipulated in Low voltage Directive (LVD) 2006/95/EC and Electromagnetic compatibility (EMC) Directive 2004/108/EC. The unit is tested based on:

EN 50178:1997
 EN 62109-1:2010
 EN 62109-2:2011
 VDE 0126-1-1:2006
 VDE 4105:2011

In case of installation in PV system, startup of the unit (i.e. start of designated operation) is prohibited until it is determined that the full system meets the requirements stipulated in EC Directive (2006/95/EC,2004/108/EC, etc.)

The X-Hybrid inverter leaves the factory completely connecting device and ready for connection to the mains , Battery and PV supply. The unit shall be installed in accordance with national wiring regulations. Compliance with safety regulations depends upon installing and configuring system correctly, including using the specified wirings. The system must be installed only by professional assemblers who are familiar with requirements for safety and EMC. The assembly is responsible for ensuring that the end system complies with all the relevant laws in the country where it is to be used.

The individual subassembly of the system shall be interconnected by means of the wiring methods outlined in national/international such as the national electric cod (NFPA) No.70 or VDE regulation 0107.

3 Introduction

3.1 Basic Feature and Different Working Modes

The X-Hybrid series including X-Hybrid ready inverter, X-Hybrid inverter and X-Hybrid battery management unit. With all these function modules, you can design your own PV Hybrid storage system as you needed. The Hybrid system need to be build with either a X-Hybrid ready inverter, a battery management unit and a battery system or a X-Hybrid inverter and a battery system. We have the below working modes for your home made energy storage system.

- **Self Use**
In the "Self Use" mode the priority of the PV generated power will be : local load> battery> public grid. It means the PV generated power will be used in local load then the battery charging and the redundancy power will be delivered to the public grid.
- **Force Time Use**
In the "Force Time Use" mode, user can set the charging and discharging time according to his wishes and also can chose if charge from grid if allowed.
- **Export control**
When the user set the export control value, the inverter can limit the energy feed in to the grid.
- **EPS mode**
The X-Hybrid E version integrated with EPS function. The inverter will automatically switch to EPS output when the grid is off. User need to set the battery remaining value for the EPS. When use the EPS function, need to fit the load power rating with the EPS power rating.

WARNING !



- Make sure the load powering rating is within the EPS's output rating, Or the inverter will shutdown with an "over load" warning .
- When an "over load" is appeared, adjust the load power make sure it is with the rang of the EPS output, and turn the inverter on.
- For the nonlinear load ,please pay attention to the inrush power make sure it is within the range of the EPS output.

3.2 Terminals of X-Hybrid Ready Inverter, X-Hybrid Inverter and BMU

X-Hybrid Inverter (SK-SU)

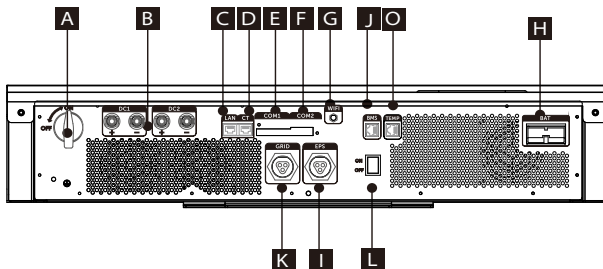

X-Hybrid Ready Inverter (SK-TL)

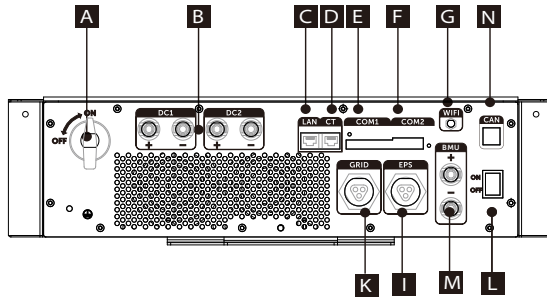

Hybrid Battery Management Unit (SK-BMU)

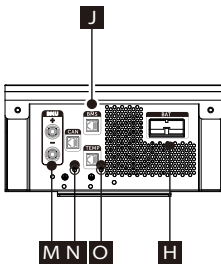

SK-BMU1300/SK-BMU2500

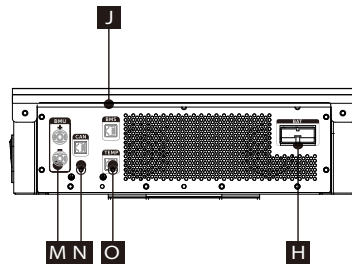

SK-BMU5000

Object	Description
A	DC switch
B	DC connector area
C	Ethernet connector
D	Outside current sensor or meter port
E	Communication port for dry contact.
F	Communication port for update.
G	Wifi antenna connector
H	Battery connector
I	EPS output
J	Battery communication port
K	Grid output
L	ON/OFF button
M	External BMU connector
N	Can communication port with external BMU
O	Temperature port for battery



WARNING !

Only qualified electricians can operate the connection.

3.3 Dimension

Dimension for SK-SU Series

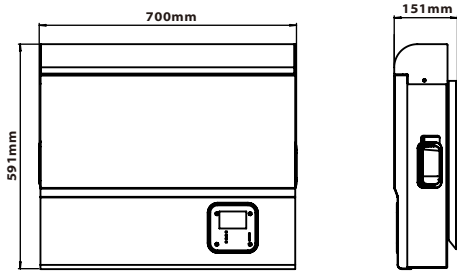

Dimension for SK-TL Series

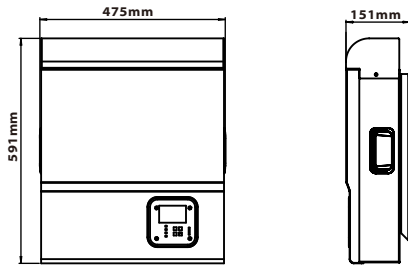

Dimension for SK-BMU Series

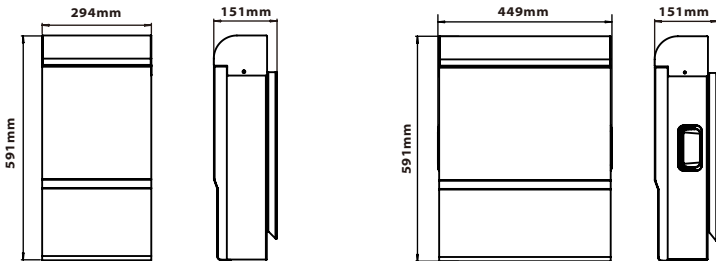

SK-BMU1300/SK-BMU2500

SK-BMU 5000

3.4 Identification of X-Hybrid

Model Name

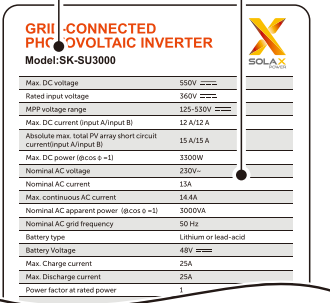

Parameter

Max. DC voltage	550V
Rated input voltage	360V
MPP voltage range	125-530V
Max. DC current (input A/input B)	12 A/12 A
Absolute max. total PV array short circuit current(input A/input B)	15 A/15 A
Max. DC power (8cos φ =1)	3300W
Nominal AC voltage	230V~
Nominal AC current	15A
Max. continuous AC current	14.4A
Nominal AC apparent power (8cos φ =1)	3000VA
Nominal AC grid frequency	50 Hz
Battery type	Lithium or lead-acid
Battery Voltage	48V
Max. Charge current	25A
Max. Discharge current	25A
Power factor at rated power	1

Series Number

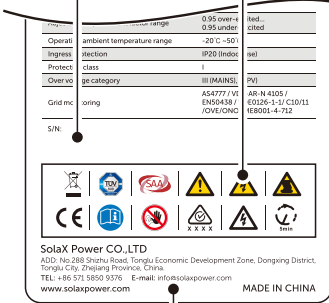

Labels

Technical specifications and safety labels from the back panel, including ambient temperature range, protection class, and various safety icons (CE, UL, IEC, etc.).

Manufacture Info

4 Technical Data for X-Hybrid Inverter

4.1 DC Input

Model	SK-TL(SU)3000	SK-TL(SU)3700	SK-TL(SU)5000
Max. DC input power (W)	3300	4000	5000
DC input Voltage range(V)	100-550	100-550	100-550
MPP voltage range(V)	125-530	125-530	125-530
Rated input voltage(V)	360	360	360
Start input voltage(V)	100	100	100
Max. DC input current per input (A)	12	12/12	12/12
Max. short-circuit current per input (A)	15	15/15	15/15
No. of MPP inputs	1	2	2
No. of strings per MPP input	1	1	1
DC Disconnection switch	Optional	Optional	Optional

4.2 AC Output

Model	SK-TL(SU)3000	SK-TL(SU)3700	SK-TL(SU)5000
Rated output power@cosφ=1(W)	3000	3680	4600
Max. apparent AC power(VA)	3000	3680	4600
Rated grid voltage(V)	230	230	230
AC voltage range(V)	180~270	180~270	180~270
AC nominal current(A)	13	16	20
Max. output current(A)	14.4	16	22.1
Max. short-circuit current(A)	40	40	50
The harmonic factor if output Current at AC THD voltage<2% AC power>0.5 nominal AC power	<3%	<3%	<3%
Rated AC frequency(Hz)	50/60	50/60	50/60
Rated AC frequency range(Hz)	44-55/55-65	44-55/55-65	44-55/55-65
Max. inverter backfeed current to the array(mA)	500	500	500
Inrush current(A)	60	60	60
Maximum output fault current(A)	150	150	150
Maximum output overcurrent protection(A)	25	25	25
Displacement power factor, adjustable	0.9 leading...0.9 lagging		
Feed in phase	Single-phase		
Over voltage category	III (electric supply side), II (PV side)		

4.3 EPS Output With Internal Charger (E Version for SK-SU)

Model	SK-SU3000	SK-SU3700	SK-SU5000
EPS rated power [VA]	2000		
Rated voltage (V)	230		
Rated frequency(Hz)	50/60		
Rated current (A)	11		
EPS Peak power[VA]	1.5xPrated, 10s		
Total harmonic distortion (THD)	<3%		
Switch time(s)	<5		

4.4 Efficiency, Safety and Protection

Model	SK-TL(SU)3000	SK-TL(SU)3700	SK-TL(SU)5000
Max. Efficiency	97.6%	97.6%	97.6%
Euro Efficiency	97.0%	97.0%	97.0%
MPPT Efficiency	99.9%	99.9%	99.9%
Safety & Protection			
Over voltage/under voltage protection	YES	YES	YES
DC isolation impedance	YES	YES	YES
Monitoring ground fault protection	YES	YES	YES
Grid monitoring	YES	YES	YES
Ground fault current monitoring	YES	YES	YES
DC injection monitoring	YES	YES	YES
Back feed current monitoring	YES	YES	YES
Residual current detection	YES	YES	YES
Anti-islanding protection	YES	YES	YES
Over load protection	YES	YES	YES
Over heat protection	YES	YES	YES

4.5 Internal Charger (for SK-SU)

Model	SK-SU3000	SK-SU3700	SK-SU5000
Battery type	Lead-acid battery/Lithium battery		
Battery nominal voltage [V]	48		
Battery voltage range [V]	40-60		
Max. charge/discharge current [A]	50(adjustable)		
Discharge depth (%)	80%(adjustable)		
Charging curve	3-stage adaptive with maintenance		
Communication interfaces	Can/RS232		
Battery temperature sensor	Yes		
Winter mode	Yes		



4.6 General Data

Model	SK-TL(SU)3000	SK-TL(SU)3700	SK-TL(SU)5000
Dimension (W/H/D) (mm)	475*591*151 (700*591*151)		
Dimension of packing (W/H/D) (mm)	724*609*282 (850*724*282)		
Weight (kg)	21(27.7)		
Gross weight (kg)	26(35)		
Cooling concept	Forced airflow		
Noise emission(dB)	<40		
Operating temperature range (°C)	-10~+50 (derating at 40)		
Store temperature (°C)	-20~+60		
Max.permissible relative humidity (non-condensing)	95%		
Pollution degree	II		
Altitude (Km)	<2000		
Degree of protection	IP20 (for indoor use)		
Topology	Transformer-less		
Internal consumption (W)	<7		
LCD display	Backlight 16*4 character		
Communication interface	Ethernet/Dry contact /wifi		
Standard Warranty	Standard 5 years		

5 Technical Data for X-Hybrid BMU

5.1 Electrical Data

Model	SK-BMU1300	SK-BMU2500	SK-BMU5000
Charger input Voltage(V)	360-460		
Charger communication with inverter	CAN		
Battery type	Lead-acid battery/lithium battery		
Battery nominal voltage [V]	48		
Battery voltage range [V]	40-60		
Discharge depth (%)	80%(adjustable)		
Max. charge/discharge current [A]	25	50	100
Charger communicate with bat.	Can/RS232		
Charging curve	3-stage adaptive with maintenance		
Battery temperature sensor	Yes		
Winter mode	Yes		

5.2 General Data

Model	SK-BMU1300	SK-BMU2500	SK-BMU5000
Dimension (W/H/D) (mm)	592*290*140		592*450*140
Dimension of packing (W/H/D) (mm)	724*409*282		724*579*282
Weight (kg)	12	12	16
Gross weight (kg)	16	16	21
Cooling concept	Forced airflow		
Noise emission(dB)	<40		
Operating temperature range (°C)	-20~+50 (derating at 40)		
Store temperature (°C)	-20~+60		
Altitude (Km)	<2000		
Degree of protection	IP20 (for indoor use)		

6 Installation

6.1 Unpacking

Check the delivery for completeness. Contact your dealer at once if anything is missing.

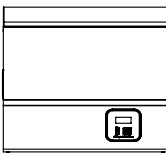

A

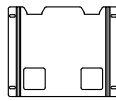

B



C



D



E



F

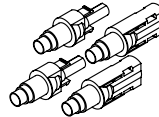

G

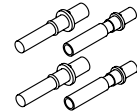

H



I

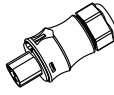

J

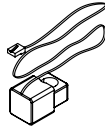

K



L

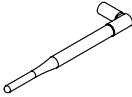

M



N

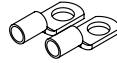

O

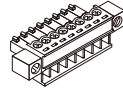

P

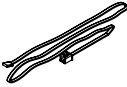

Q



R



S



T

Object	Quantity	Description
A	1	X-hybrid series inverter
B	1	Bracket
C	1	Warranty card
D	1	User manual
E	4	Expansion tubes
F	4	Expansion screws
G	2/4	DC connectors 2 units (1* positive ,1* negative) for SK-TL3000/SK-SU3000 4 units (2* positive ,2* negative)
H	2/4	DC Pin contact 2 units (1* positive ,1* negative) for SK-TL3000/SK-SU3000 4 units (2* positive ,2* negative)
I	1	AC connector
J	1	EPS connector(only for E-version)
K	1	Current sensor
L	1	RJ 45 extend port for current sensor
M	1	WIFI antenna
N	1	Battery connector (for SK-SU only)
O	2	Circuit cord end terminal for battery(for SK-SU only)
P	1	8 pin terminal block male connector for dry connector.
Q	1	Battery thermal sensor (for SK-SU only)
R	1	Wrench tool for separate DC connector
S	1	Quick installation guide
T	1	WIFI setting guide

Open the package and pick the product, check that if there is any distortion or impaired during the transportation. Meanwhile, check that if the relating accessories and the materials are here, you can see the accessories list in the table.

The instruction manual is an integral part of the unit and should therefore be read and kept carefully.

It is recommended that the packaging should not be removed until the unit is located in the installation site.

6.2 Check for Transport Damage

Check if the X-hybrid series inverter has some visible external damage , such as cracks in the housing or display please contact with your dealer if you find any damage.

6.3 Installation Precaution

The X-hybrid series inverter is designed for indoor installation (IP20)
Make sure the installation site does not fall into one of the following conditions:

- Do not install the inverter in direct sunlight.
- Do not install the inverter on flammable construction material.
- Do not install the inverter in areas where highly flammable materials are stored.
- Do not install the inverter in potentially explosive areas.
- Do not install the inverter during periods of precipitation or high humidity (>95%); Moisture trapped within the location may cause corrosion and damage to the electric components.
- Provide adequate ventilation when using batteries, and also read the warning label on the bottom of the inverter.
- Install the inverter in a location that maintains an ambient air temperature that is less than 40°C; That is to maintain a safe internal component temperature, the inverter would reduce power if the ambient air temperature exceeds 40°C.
- The inverter should be installed in a location that is not accessible for children.
- The inverter emits a slight vibrating noise when operating, which is normal and no effect on performance.
- The slope of the wall should be within $\pm 5^\circ$.
- The inverter is heavy, ensure the mounting place is strong enough to hold the weight of the inverter.
- If you install the inverter in a cabinet, closet or other small enclosed area, sufficient air circulation must be provided in order to dissipate the heat generated by the unit.

Available Space Size

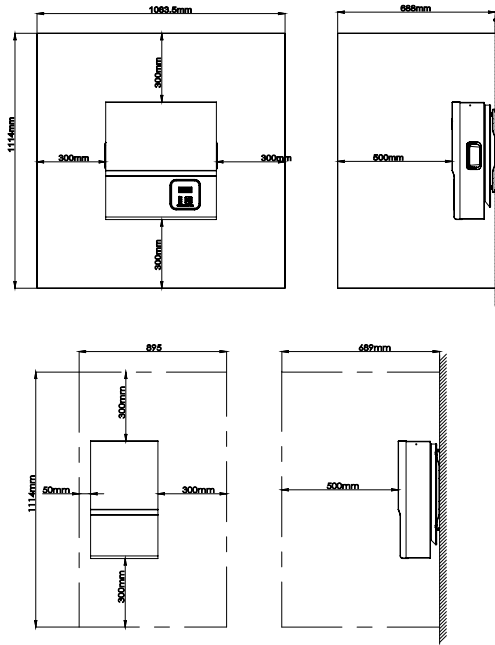

WARNING !

Before installation and maintenance, AC and DC side doesn't carry electricity, but if DC side is just disconnected, capacitance still contains electricity, so please wait for at least 5 minutes to ensure the capacitors completely release the energy and inverter is not electrified.



NOTE !

Inverters should be installed by technicians.

6.4 Preparation

Below tools are needed before installation.



Installation Tools

Installation Tools: crimping pliers for binding post and RJ45, screwdriver, manual wrench, ϕ 6 drill and rubber hammer.

Lifting and Handling

The unit is heavy. Do not lift it alone.

- During lifting procedures ensure that the unit is firmly secured to avoid the risk of accidental tipping or dropping.
- Parts serving for support or immobilization of unit shall be designed and manufactured so as to minimize the risk of physical injuries and of accidental loosening of fixing.
- Ensure that the method of lifting will not allow the unit to slip from chains and slings or turn-over or slide from lifting devices.
- Transportation must be carried by specialized person (truck operators, Hook-up personal), equipped with the necessary protection equipments (overalls, safety shoes, protective gloves, helmets, goggles)
- Do not walk or stand beneath or in the proximity of the load.
- Avoid sudden movements and jolts when unloading and positioning the unit. Internal handling procedures must be conducted with care. Do not exert leverage on the components of the machine.
- If the unit is not balanced apply ballast. Any protruding parts should not be supported by hand.
- The inverter should be installed so that the operating panel shall be easily accessible- easy access to the electrical power connection point.
- Accessible for maintenance and repair work.
- Parts serving for support or immobilization of unit shall be designed and manufactured so as to minimize the risk of physical injuries and accidental loosening of fixings.
- Loading capacity and hardness of the supporting surface, load rating of mounting bracket should be at least four times the weight of the devices according to IEC62109-1. and supporting characteristics will be impaired by wear, corrosion, material fatigue or ageing, This should be calculated by inspection of the design data of supporting material and consulting construction engineer.

6.5 Installation Steps

Step1: Screw The Wall Bracket on The Wall

- Use the wall bracket as a template to mark the position of the 4 holes.
- Drill holes with $\phi 6$ driller carefully, make sure the holes are deep enough (at least 50mm) for install and tight the expansion tubes.
- Install the expansion tubes in the holes, and tight them . Install the wall bracket using the expansion screws in the screw package.

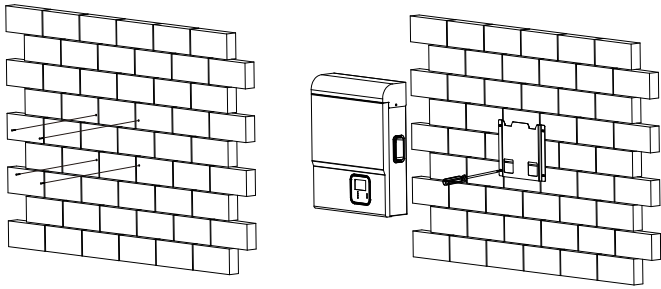

Step2: Hang the X-hybrid Inverter On the Wall Bracket.

- Transportation of the inverter needs at least 2 people, each one needs to use the handles at the sides of the inverter.
- Hang the inverter over the bracket, move the inverter close to it, slightly lay down the inverter make sure the 4 mounting bars on the back of the inverter is fixed well with the 4 grooves on the bracket.

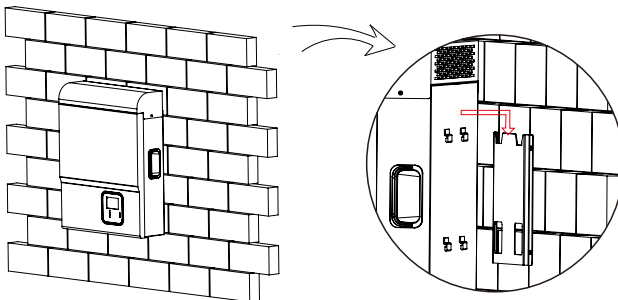

Note:The installation of SK-BMU is the same as above.

6.6 Connections of The X-hybrid System

6.6.1 The Main Steps to Connect The X-Hybrid System

- PV string connection
- AC output connection
- Battery connection (for SK-SU series)
 - Battery power connection
 - Battery communication connection
 - Battery thermal sensor connection
- Current sensor connection
- EPS connection (for E version)
- Earth connection
- Wifi connection

- PV string connection



WARNING!

PV module voltage is very high which belongs to dangerous voltage range, please comply with electric safety rules when connecting.



WARNING!

When the photovoltaic array is exposed to light, it supplies a D.C voltage to the P.CE.



WARNING!

When there is something wrong with the modules arrays. Modules can be connected with inverter only after eliminating these problems.

X-hybrid series inverters can be connected in series into 2-strings PV modules for 3.7KW and 5KW, and 1-string PV module for 3KW.

Please select PV modules with excellent function and reliable quality.

Open-circuit voltage of module arrays connected in series should be <Max. DC input voltage; Operating voltage should be conformed to MPPT voltage range.

Table 3 Max. DC Voltage Limitation

Model	SK-TL(SU)3000	SK-TL(SU)3700	SK-TL(SU)5000
Max. DC Voltage(V)	550		
MPPT voltage range(V)	125-530		



NOTE!

The following requirements of PV modules need to be applied for each input area;

- Same type
- Same quantity
- Identical alignment
- Identical tilt

Please use PV cable to connect modules to inverter. From junction box to inverter, voltage drop is about 1-2%. So we suggest the inverter install near PV module, in order to save cable and reduce DC loss. (No longer than 30m)



NOTE!

Please do not make PV positive or negative ground!

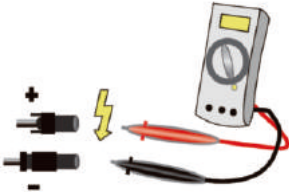

- Use multimeter to measure module array voltage
- Check the PV+ and PV- from the PV string combiner box correctly. Make sure the PV+ and PV- connected correctly.

• Connection Step:

1. Disconnect the DC switch.
2. Choose 12 AWG wire to connect the PV module.
3. Strip 6mm of insulation from the Wire end.

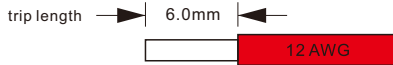

4. Separate the DC connector as below.

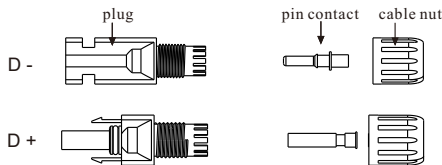

5. Insert striped cable into pin contact and ensure all conductor strands are captured in the pin contact.
6. Crimp pin contact by using a crimping pliers. Put the pin contact with striped cable into the corresponding crimping pliers and crimp the contact.

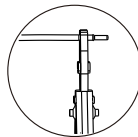

7. Insert pin contact through the cable nut to assemble into back of the male or female plug. When you feel or heard a "click" the pin contact assembly is seated correctly.

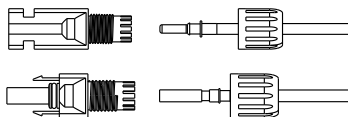

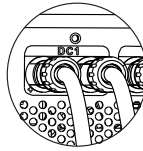

10. Separate the DC connector
 - a. Use the specified wrench tool.
 - b. When separate the DC+ connector, push the tool down from up side.
 - c. When separate the DC- connector, push the tool down from the bottom side.
 - d. Separate the connectors by hands.



WARNING!

Before connecting, disconnecting the connection between solar generator and inverter and locked it to the open position during installation. Place a warning sign “do not turn on maintenance in progress” on the external disconnect switch when it is shut down, and make sure that on-off remote controls are inhibited.

• AC Output Connection



WARNING!

Must comply with the connection requirement of your distribution grid.

X-hybrid series inverters are designed for single phase grid. Voltage range is typical 230V according to different countries. The typical frequency is 50Hz/60Hz. Other technical requests should comply with the requirements of local public grid. For the terminal and cable design please follow below requirements.

Terminal capacity and Identification.

	Connection type	Rated connecting capacity and rating	Tightening torque	Stripping length
Protective earthing connection	Torx-head Screw(m5)	-----	1.8-2Nm	11mm
DC input connection	Amphenol(MC4)		1.8-2Nm	-----
AC output connection	Wieland		1.8-2Nm	-----
EPS output connection	Wieland	-----	-----	-----
RS485	Connector			

Earth conductor: PE screw terminal designed for clamping a cable lug or bar by means of a screw, nut and locking washer, before PE connection, strip the conductor end 12mm long to fit them into a cable lug or bar. For PE connection, the length of conductors between the cord anchorage and the terminal, shall be such that the current-carrying conductors became taut before the earthing conductor if the cable slips out of the cord anchorage.

Model	SK-TL(SU)3000	SK-TL(SU)3700	SK-TL(SU)5000
Cable(Cu)	4-5mm ²	4-5mm ²	5mm ²
Micro-Breaker	20A	20A	25A



WARNING!

Make sure you select the correct specification cables for installation. Otherwise the power will make the cable hot or burnt, it could result in death or serious injury

Connection Step:

1. Check the grid voltage and compare with the permissible voltage range. (see technical data).
2. Disconnect the circuit-breaker from all the phases and secure against re-connection.
3. Trip the wires:
 - a. Trip all the wires to 52.5mm and the PE wire to 55mm.
 - b. Use the crimping pliers to trip 12mm of insulation from all wire ends as below.

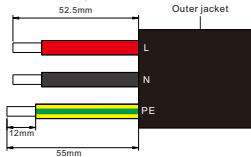

4. Separate the AC plug into three parts as below.
 - a: Hold the middle part of the female insert, rotate the back shell to loosen it, and detach it from female insert.
 - b: Remove the cable nut (with rubber insert) from the back shell.

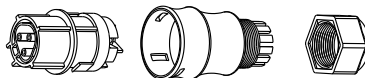

- 5: Slide the cable nut and then back shell onto the cable.

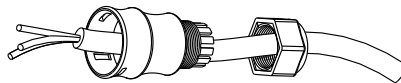

6. Insert the tripped end of each three wires into the appropriate hole in the female insert, and then tight each screw (to tight each wire in place).

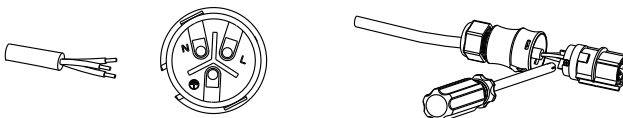

7. Screw down the threaded sleeve the pressure screw.

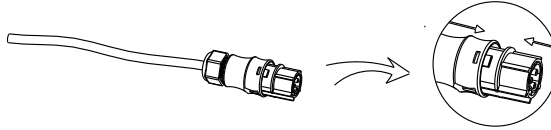

8. Screw down the pressure screw.

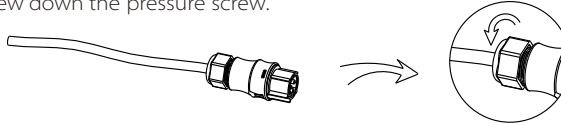

9. Connect the AC plug to the inverter.



Selection of Fuse and Cables

Mains cable (AC line cable) shall be short circuit protected and thermal overload protected.

Always fit the input cable with fuse. Normal gG(US:CC or T) fuses will protect the input cable in short circuit situation. They will also prevent damage to adjoining equipment.

Dimension the fuses according to local safety regulations. Appropriate input voltage and the related current of the solar inverter.

AC output protected by external fuse (gG rated current 20A/250VAC for 3KW and 3.7KW; 25A/250VAC for 5KW) provide in all live connections to the AC supply. The rated short circuit breaking capacity of the above protective device shall be at least equal to the prospective fault current at the point of installation. See section technical data of this manual for details.

Ac output cable: Cu, L, N+PE,2*5 .0+5.0mm² @40°C ambient with a max length of 5m with operating time of the fuse is less than 5seconds, installation method B2 according to EN60204-1:2006, annex D: cable in conduit cable trunking system, number of loaded circuit only one . Use H07RNF (cord designation 60245 IEC66) for an ambient temperature between 40°C and 60°C.

Note1: For conditions differing form those mentioned above ,dimension the cables according to local safety regulations, appropriate input voltage and the load and the load current of the unit.(You can choose a thicker cable but the fuses must rated according to the cable.)

Note2: Fuses must be approved by Notified Body.

Inverter is not provided galvanic isolation from the mains to the PV array, backfeed current to the array is 20A/250VAC for 3KW and 3.7KW; 25A/250VAC for 5KW, based on the fuse provided in the mains. Also in the worst case .the reverse current comprises the sum of the short-circuit currents of all intact lines.

There for the current-carrying capacity of the components and sub-assemblies provided in the end-use system(connectors ,cables, junction box, switch ger,etc.), and the reverse current PV module shall be considered based on the backfeed current and reverse current. The direct current (DC) circuit breaker or fuse between each solar generator and inverter shall be provided based on solar inverter input ratings.

Select DC cables based on the above inverter back-feed current and Isc PV rating and Vmax ratings.

• **Battery Connection (for SK-SU Series)**

When you want to build a self-use storage system , the battery is a necessary part.The X-hybrid E SK-SU series inverter provide the necessary part of the interfaces to connect the battery to the inverter.



WARNING!

Make sure you select the correct specification cables for installation. Otherwise the Power will make the cable hot or burnt, it could result in death or serious injury.

① **Battery power connection .**

1. Connect one side of the battery connect wire to the inverter.
2. Fit a fuse (63A slow blow) in the both positive and negative battery cable as close as possible to the battery.
3. Connect the positive side of the battery connect wire to the positive side of the battery , the negative side of the battery connect wire to the negative side of the battery.
4. Make sure the positive and negative of the battery are correct.

② **Battery communication connection .**

Communication

The communication interface between battery and inverter is RS232 or CAN with a RJ45 connector. The Pin definition is as below.

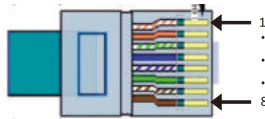

Pin	1	2	3	4	5	6	7	8
Function	CANH	CANL	GND	RS232_TXD	RS232_RXD	GND	X	X

Connection steps

1. Prepare RJ45 connectors and a communication cable.
2. Strip the insulation from the communication cable.
3. Insert the communication cable into the RJ45 connector following the PIN definition rule at both sides.
4. Crimp the RJ45 connector with the crimping plier.
5. Insert one RJ45 side of the cable into BMS port on the inverter and another into RS232 port to the battery.

Note: The battery communication can only work when the battery BMS is compatible with the inverter.

③ Battery thermal sensor connection

The thermal sensor is used to monitor the temperature of the environment, to do the temperature compensation and be ready for the winter mode for the winter. The winter mode is used to prevent the battery from the low temperature injury.

Connection Step:

1. Set the RJ45 connector of the thermal sensor to the "TEMP" port of the inverter or the BMU.
2. Place the other side ring of the thermal sensor near the battery for sampling the ambient temperature of battery.

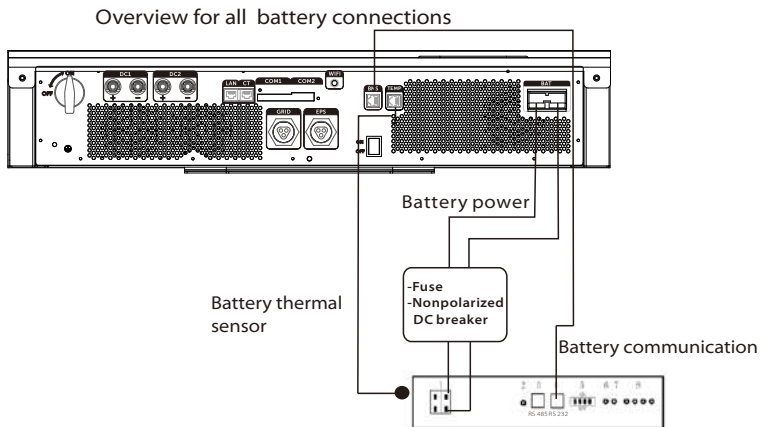

• Current sensor connection

The current sensor measures the current on the phase wire that runs between the inverter and the grid. This enables the inverter to determine the Power requirements of the connected consumer. The current sensor is connected to the CT port on the inverter.

Connection Step:

1. Insert the RJ45 terminal on the current sensor into the CT port on the inverter.
2. Place the current sensor around the phase wire L which the inverter is connected.
3. Place the current sensor around the phase wire L to measure the current going to or coming from the grid.
4. Make sure the current sensor is installed in the right direction: The arrow on the current sensor must point to the public grid.

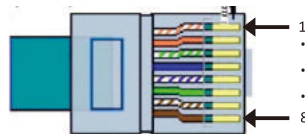
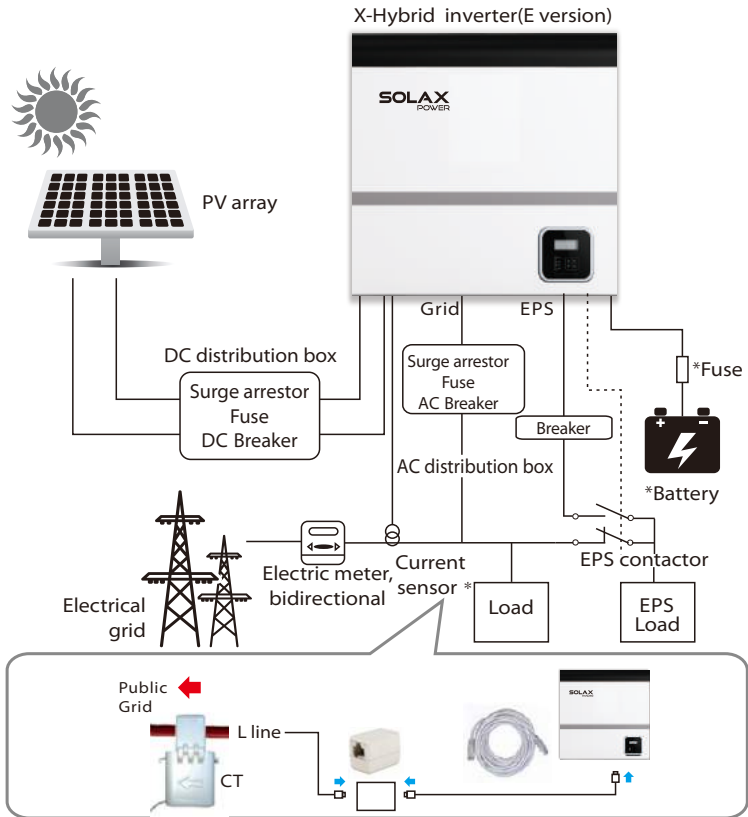

When connecting the RJ45 connector with the wire of the CT or Meter, please follow the below sequence:

Pin	1	2	3	4	5	6	7	8
CT	Red wire	X	X	X	X	X	X	Green wire
Meter	X	X	X	Blue wire	White wire	X	X	X



NOTE!

- Do not place the sensor on the N Wire or the earth wire.
- Do not place the sensor on the N and L wire simultaneously.
- Do not place the sensor on the L wire going to the consumer.
- Do not place the sensor with the arrow pointing to the generation meter.
- Do not place the sensor on the non-insulated wires.
- Do not use the wire over 25m.



NOTE!

- The sensor can be upgraded to meter.
- With a one phase meter provided by SolaX can monitoring the 24hr usage of electric.
- With a three phase meter provided by SolaX can implement three phase compensation.

• EPS connection

The X-hybrid E inverter has on and off grid function, the inverter will have output through the grid output when the grid is on, and will have output through the EPS output when the grid is off.

When user want to use the off grid function , need to switch the load to the EPS output manually. or install an external EPS contactor to do the automatical Switch.

Connection Steps:

- 1:For tripping the wires ,please refer to the steps of AC connection.
- 2.Separate the EPS plug into three parts as below.
 - a: Hold the middle part of the female insert,rotate the back shell to loosen it, and datach it from female insert.
 - b:Remove the cable nut(with rubber insert) from the back shell.



- 5:Slide the cable through back shell and cable nut.(Here only needs two cables,L and N.)

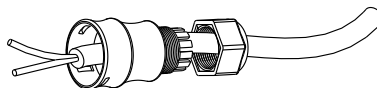

6. Insert the tripped end of each two wires(L and N) into the appropriate hole in the female insert,and then tight each screw(to tight each wire in place).

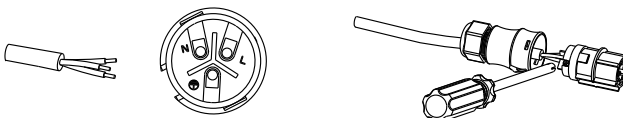

7. Screw down the threaded sleeve the pressure screw.

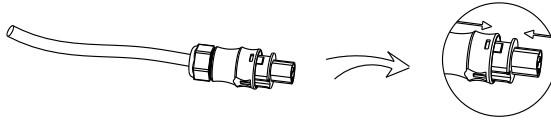

8. Screw down the pressure screw.

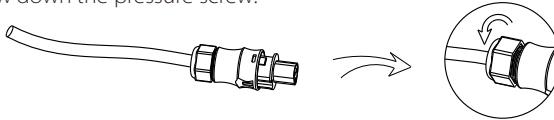

9. Connect the EPS plug to the inverter.





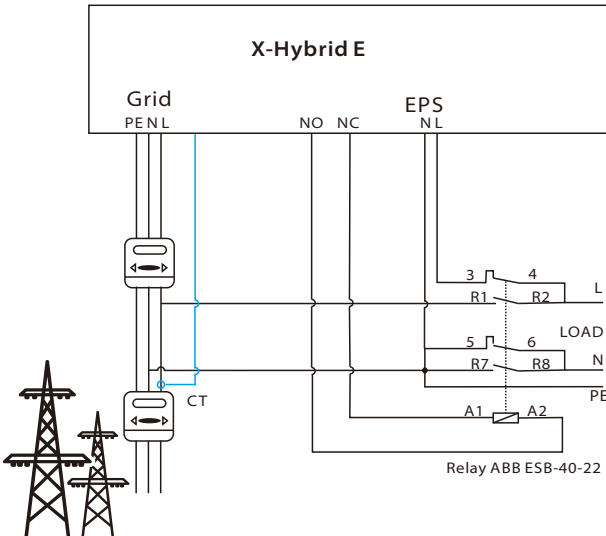





The connection for wiring the EPS contactor is as below.



WARNING!

Usually the capacitive load and inductive load will cause large current. Please consider the inrush current of the load when connect the EPS load.

Below table shows some conventional and reasonable loads for you reference.

Type	Power		Common equipment	Example		
	Start	Rated		Equipment	Start	Rated
Resistive load	X 1	X 1	  Incandescent lamp TV	 100W Incandescent lamp	100VA (W)	100VA (W)
Capacitive load	X 2	X 1.5	 Fluorescent lamp	 40W Fluorescent lamp	80VA (W)	60VA (W)
Inductive load	X 3~5	X 2	  Fan Fridge	 150W Fridge	450-750VA (W)	300VA (W)

●Earth connection.

You can additionally earth the inverter enclosure of a second earthing or equipotential bonding is required locally. This prevents touch current if the original protective conductor fails.

Cable size: 12AWG.

Connection step:

1. Strip the earthing cable insulation.
2. Insert the stripped cable into the ring terminal.
3. Clamp the end of the ring terminal.
4. Unscrew the screw of the earthing connector.
5. Suit the ring terminal on the earthing connector. Suit the gasket on the earthing connector.
6. Screw the screw of the earthing connector.

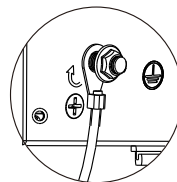
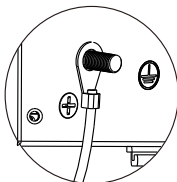

• Wifi connection

Wifi communication interface is a standard interface, you can read the real time data in the local network by your smartphone or check the details from the internet either from PC or smartphone with the wifi monitoring.

Connection steps :

1. Install the antenna on the inverter.
2. Connect the wifi with the router. (as described in the wifi setting guide)
3. Set the station account on the solax web.(as described in the wifi setting guide)

6.6.2 Communication Interface

This product has a series communication interfaces besides WIFI , LAN, Dry contact and extend port and for human and machine communication. Operating information like output voltage, current, frequency, fault information, etc., can be delivered to PC or other monitoring equipments via these interfaces.

① LAN

• Communication

LAN communication is one standard communication interface. It transmits the data between the router and X hybrid series inverters in the local area network. User can set the parameters with specialized software provided by Solax. The pin definition of the connector is as below.

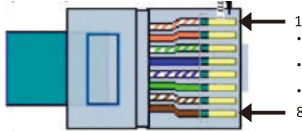

Pin	1	2	3	4	5	6	7	8
Function	TPTX+	TPTX-	2.5V	GND	GND	2.5V	TPTX+	TPTX-

• Connection steps

1. Prepare two RJ45 connectors and a communication cable.
2. Strip the insulation from the communication cable.
3. Insert the communication cable into the RJ45 connector following the PIN definition rule.
4. Crimp the RJ45 connector with the crimping plier.
5. Repeat the above steps to fix the other head of the communication cable.
6. Insert one side of the cable into the LAN port on the inverter, and the other side of the cable into the router or into the PC if you want to set the parameters or upgrade the software with Solax-3S.

② Dry contact

• Communication

Dry contact is provided to give a remote monitor and remote control with the optional accessory. The remote monitor function provides an indication on the inverter's working status. The remote control function provides a contact signal to operate the inverter. The dry contact communication uses terminal blocks. The PIN definitions and the circuit connection are as below.

Pin	1	2	3	4	5	6	7	8
Definition	Remote control for reactive power regulation						EPS control	

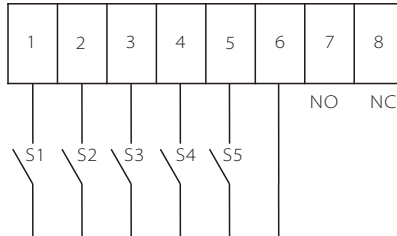

• Connection steps

1. Choose at least 1mm² wire. Trip the insulation from the wire ends.
2. Insert the tripped wire into the holeS of the terminal block.
3. Screw down the screws on the terminal block.

6.7 Inverter Manipulation

Start inverter after checking all below steps:

- Check that the device is fixed well on the wall.
- Make sure all the DC wirings and the AC wirings are completed.
- Make sure the CT is connected well.
- Make sure the battery is connected correctly.
Make sure the external EPS contactor is connected. (if needed)
- Turn on the external AC ,DC switch.
- Turn on the DC switch to the “ON” position.
- Turn on the on/off Button on the inverter.

Start inverter

- Inverter will start automatically when the PV panel generate enough energy or the battery is charged.
- Check the status of LED and LCD screen, first LED should be green and the LCD screen should display the main interface.
- If first LED is not green, please check the below:
 - All the connections are right.
 - All the external disconnect switches are closed.
 - The DC switch of the inverter is in the “ON” position.
- Enter the setting interface.
- Set the safety standard as page 41.
- Set the system time as page 41.
- PV connection mode as page 42.
- Set the work mode as page 43.
- Set charger as page 44.
- Set the EPS as page 46.
- Set WIFI according to the wifi manual.



NOTE !

Please set the inverter if it is the first time to start up.

Above steps is for the regular start up of the inverter. If it is the first time to start up the inverter, you need to setup the inverter .

7 Operation Method

7.1 Control Panel

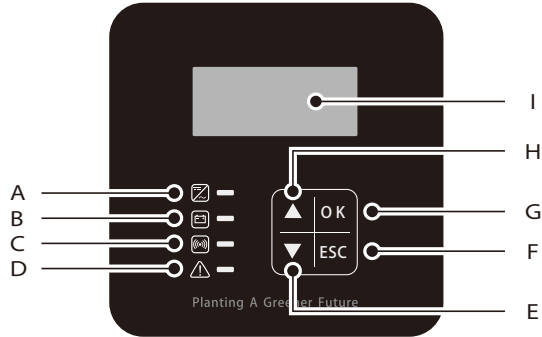

Object	Name	Description
A	Indicator LED	Green: Normal working status.
B		Blue: Battery charging or discharging.
C		Yellow: Communication status.
D		Red: Error.
E	Function Button	Down button: Move cursor to downside or decrease value.
F		ESC button: Leave from current interface or function.
G		OK button: Confirm the selection.
H		Up button: Move cursor to upside or increase value.
I	LCD Screen	Display the information of the inverter.

7.2 LCD Function

Menu structure

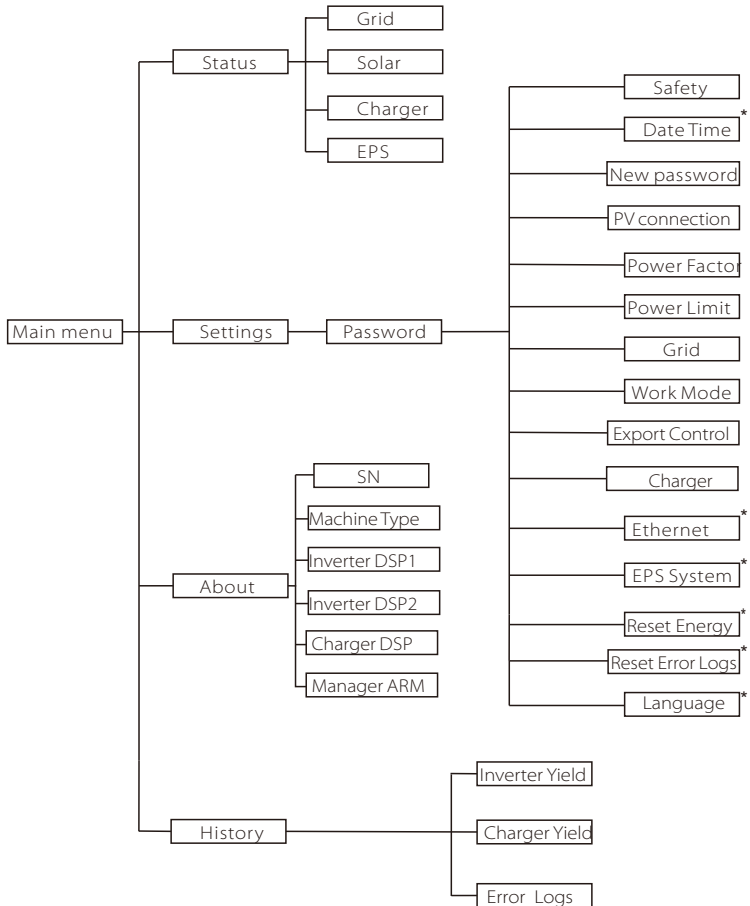

Note:* Can be set by the end user.
Others can only be set by the technical or the installer with the installer password.

7.3 LCD Operation

- LCD Digital Display

The main interface is the default interface, and the inverter will automatically jump to this interface when the system starts up successfully or be not operated for a period of time.

The information of the interface is as below. The “Power” means the timely output power; “Today” means the power generated within the day. “Battery” means the left percentage of battery energy.

“Normal” show the status of the inverter.

Power	0W
Today	0.0KWh
Battery	%
Normal	

- Menu Interface

The main interface is a transfer interface for user to get into the other interface to finish the setting or to get the information.

- User can get into this interface by pressing “OK” button when the LCD displays the main interface.
- User can select interface by moving the cursor with the function button, and press “OK” to confirm.

Menu	
Status	
History	
Settings	

- Status

The status function contains four aspects of the inverter, grid , solar, battery and EPS.

Press up and down to select and press “OK” to confirm the selection, press “ESC” to return to the Menu.

Status	
Grid	
Solar	
Battery	

A) Grid

This status shows the real time grid condition such as voltage, current, output power and the local consumed power . Pout measures the output of the inverter, Pgrid measures the export to or import from the grid. Positive value means the energy feed into grid. Negative value means the energy used from grid.

Press up and down button to review the parameter. Press “ESC” to return to Status .

Grid	
U	000.0V
I	00.0A
P	00.0W

B) Solar

This status shows the real time PV condition of the system. The input voltage, current and power situation of each PV input.

Press up and down button to review the parameter. Press "ESC" to return to Status .

Solar	
U1	360.0V
I1	1.0A
P1	360W

C) Charger

This status shows the charger situation of the system. Include the battery voltage, charge or discharge current. Charge or discharge power, battery capacity and battery temperature. "+" means in charging; "-" means in discharging. Press up and down button to review the parameter. Press "ESC" to return to Status.

Charger	
U	54.0V
I	+1.0A
P	+54W

D) EPS

EPS will only have data when the inverter is working in EPS mode, it will show the real time data of the EPS output. As voltage, current, power, frequency.

Press up and down button to review the parameter. Press "ESC" to return to Status.

EPS	
U	220V
I	12A
P	2640W

● History

The history function contains three aspects of the information: inverter yield, charger yield and error log.

Press up and down to select, and press "OK" to confirm the selection, press "ESC" to return to the Menu.

History	
Inverter Yield	
Charger Yield	
Error Logs	



A) Inverter Yield

The inverter yield function contains the energy generated by today, yesterday, this month, last month and total. Press up and down button to review the parameter. Press "ESC" to return to History .

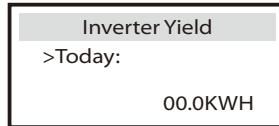

B) Charger Yield

The charger Yield function contains the energy generated from battery by today, yesterday, this month, last month and total.

Press up and down button to review the parameter. Press "ESC" to return to History .

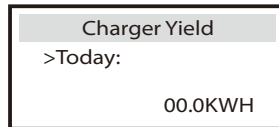

C) Error Logs

The Error logs contain the error information happened, Which can record for three items.

Press up and down button to review the parameter. Press "ESC" to return to History .

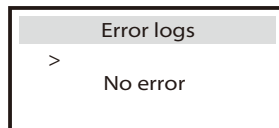

● Settings

Setting function is used for setting the inverter for time, connection, battery, Ethernet, Grid and so on.

Since this function will change the inverter's parameter, the end user with the user password as"0000" have the limited authority to change the settings.

We need installer password to do most of the professional settings.

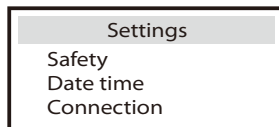

A) Password

The default password is "0000" for end user, Which only allow the user to review the current setting and some easy settings . If professional change is needed , please contact with the distributor or factory for the installer password. we need to increase or decreased the word by pressing up or down button. Press "OK" to confirm and alternate to the next word. After all when the words are confirmed. Press "OK" to enter the setting page.

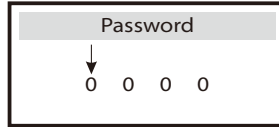

B) Safety

The user can set the safety standard here. According to different countries and grid tied standars. There are 8 standards for choice.(May change without notice)

Item	1	2	3	4	5	6	7	8	9
Standard	VDE0126	CEB	EN50438_DK	EN50438_NL	E8001	C10/C11	G83/2	AS4777	ARN4105
Country	German	UK	Danmark	Netherland	Austria	Belgium	UK	Australia	German



C) Date time

This interface is for user to set the system date and time. Increase or decrease the word by pressing up or down button. Press OK to confirm and alternate to the next word. After all the words are confirmed. Press "OK" to enter the date and time.

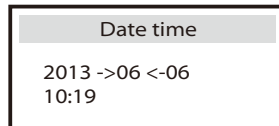

D) New Password

User can set the new password here. We need to increase or decreased the word by pressing up or down button. Press "OK" to confirm and alternate to the next word. After all the words are confirmed. Press "OK" to reset the password.



E) PV Connection

This function can set the mode of PV input. There are two modes for choice: Comm and Multi. The "Comm" mode mean single MPP tracking ,2 MPPT working together; "Multi" means multi-MPP tracking, 2 MPPT work independently. Press up or down button to select and press "OK" to confirm.

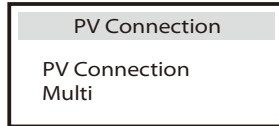

F) Power factor(For specific country if required by the local grid)

User can set the power factor here. There is 4 modes for select: OFF, Under-Excited, Over-Excited, Curve.

Select "off" to turn off this function. Select "Under-Excited " to set the inductive power factor. Select "Over -Excited " to set the capacitive power factor . Select Curve to set the power factor including "Upper limit", "Lower limit," power upper" and "power lower" according to below curve. "upper limit" and "Lower limit" can set the parameter from 0.90 to 1.00. "power upper " and "power lower " can set the parameter from 0.00 to 1.00.

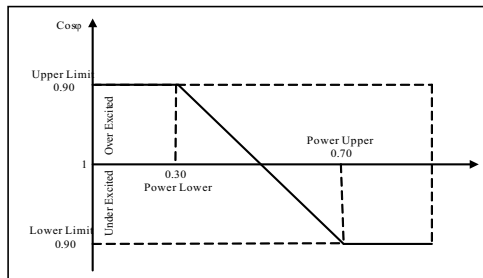
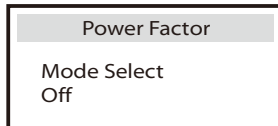

G) Power limit

User can set the output power limitation of the inverter here, the setting value is from 0.00-1.00.

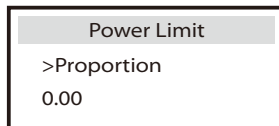

H) Grid

Usually user do not need to set the parameters here, as when you select the safety the default value will be used according to the safety rules. The parameters here is described as below. If need to reset, please contact with your installer. Any changes should according to the requirement of the local grid. Press up or down button to select and press "OK" to confirm.

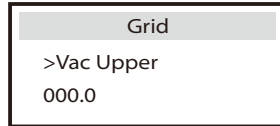

Parameter	Comment
Vac upper	Voltage high protect
Vac lower	Voltage low protect
Vac upper slow	Voltage high slow protect
Vac lower slow	Voltage low slow protect
Fac upper	Frequency high Protect
Fac lower	Frequency low protect
Fac upper slow	Frequency high slow protect
Fac lower slow	Frequency high slow protect
Vac 10m avg	10 min voltage high protect

I) Work mode

The default work mode of the inverter is Self Use mode. User can set the work mode as Self Use or Force Time Use here as describe in 3.1.

For the Force Time Use. User can set 2 periods of the start and end time of charger or discharge. Also can select if charging from grid for each charging period.

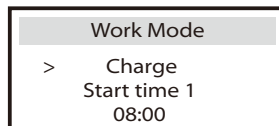
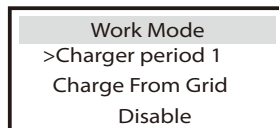
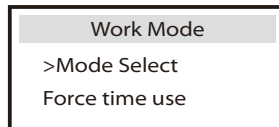



Parameter	Comment
Charger start time1	The start time of the first charger period.
Charger end time1	The end time of the first charger period.
Charger start time2	The start time of the second charger period.
Charger end time2	The end time of the second charger period.
Discharger start time1	The start time of the first discharger period.
Discharger end time1	The end time of the first discharger period.
Discharger start time2	The start time of the second discharger period.
Discharger end time2	The end time of the second discharger period.

J) Export control

With this function the inverter can control the energy exported to the grid. There is user value and factory value. The factory value is default which can not be changed by user. the value setting by the installer must be less than the factory value and within the range of the CT as 5KW or the meter as 13KW. Press up or down button to select and press "OK" to confirm.



K) Charger

Here the user can set the parameters of charger, The inverter is compatible with Lead acid and lithium batteries. Users can set the battery type, charge and discharge parameters,awaken mode here.Press up or down button to select and press"OK" to confirm. For the detailed parameters , please refer to below table.

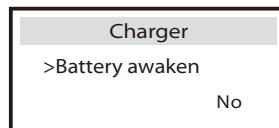
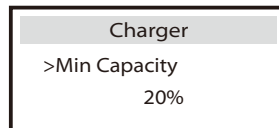
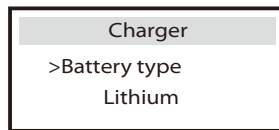

Parameter	Comment
Min capacity *	The remaining capacity of the battery when inverter is working in online mode.
Charge Cut Voltage	When the battery voltage reached this value , the BMU will stop charging the battery.
Discharge Cut Voltage	When the inverter is working in online mode. the battery voltage reached this value , the BMU will stop discharging the battery.
Charge Max Current	The charge current can be set for 0-25A. The charge power can also be set.
Discharge Max Current	The discharge current can be set for 0-25A. The charger power can also be set.
Battery awaken	When the battery voltage drops too low to work,choose this option "Yes" to make battery charging from PV or grid forcibly only if the BUS voltage ranges 300V above.

Note:Only in lithium battery mode,the parameter"Min capacity" need to be set

Example:

Lithium Battery: usually the lithium will have communication with the inverter.when the BMS is connected all the charger setting will updated to the default value as below.

	SK-BMU1300	SK-BMU2500(SU)	SK-BMU5000
Min capacity:	20%	20%	20%
Charger cut voltage:	53.5V	53.5V	53.5V
Discharge cut voltage	47V	47V	47V
Charge Max current:	25A	50A	100A
Discharger Max current	25A	50A	100A
Battery backup discharge Volt	46V	46V	46V

Lead acid battery : all the data need to be set as the suggestion from the battery Supplier. For default setting is as below.

	SK-BMU1300	SK-BMU2500(SU)	SK-BMU5000
Charger cut voltage:	54V	54V	54V
Discharge cut voltage	47V	47V	47V
Charge Max current:	25A	50A	100A
Discharger Max cut voltage	25A	50A	100A
Battery backup discharge Volt	46V	46V	46V

Note:Installer can set the parameters manually .The parameters"Battery backup discharge Volt" need to be set in the EPS System page.



L) Ethernet

Users can set the information about Ethernet here , such as IP address, subnet mask number, and default gateway number. Press up or down button to select and press "OK" to confirm.

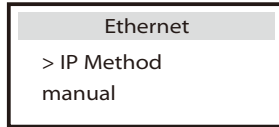

M) EPS system (For E version only)

For the Solax hybrid E version the inverter can work in the EPS mode. Installer can set the EPS parameters here. "Mute" means you can set the warning of system which has entered EPS mode. "No" means there will be a buzzing and it is the default value. "Yes" means you choose to shut down the warning function. Besides ,if the buzzing is sharp, it means EPS output takes over loads. "Frequency" here can be set 50Hz or 60Hz please based on correlative loads. "Backup setting" here can be set "Battery backup discharge Volt". End user can only set the "Mute" and "Frequency" here.

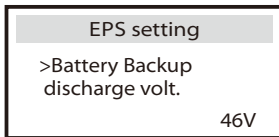
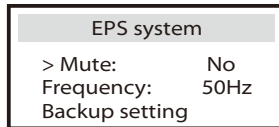

 **NOTE!**

- When you want to use the EPS function, the setting of the discharge cut voltage need to be higher than the Battery backup discharge Volt.
- The Battery backup discharge Volt is the min Voltage of the battery.

1. In online mode,the discharge cut voltage is 47V. In EPS mode ,the battery backup discharge voltage is 46V.
2. You can adjust the discharge cut voltage and the battery backup discharge Voltage or increase Min capacity to adjust the Capacity for EPS usage in case you have frequently power cut .

N) Reset energy

User can reset the energy record here. Press up or down button to select and press "OK" to confirm.

Reset energy
Whether Reset
No

O) Reset error logs

User can reset the error log here. Press up or down button to select and press "OK" to confirm.

Reset error logs
Whether Reset
No

P) Language

User can choose the language "English" or "Deutsch" here. Press up or down button to select and press "OK" to confirm.

Reset error logs
Whether Reset
No

- **About**

This interface shows the information of the inverter , Such as series numbers, and software version.

About
SN
XXXX XXXX XXXX XX

8 Troubleshooting

8.1 Trouble Shooting

This section contains information and procedures for solving possible problems with the X-hybrid series inverters, and provides you with trouble shooting tips to identify and solve most problems that could occur with the X-hybrid series inverters.

This section will help you narrow down the source of any problems you may encounter. Please read the following troubleshooting steps.

- Check the warning or fault messages on the System Control Panel or Fault codes on the inverter information panel. If a message is displayed, record it before doing anything further.
- Attempt the solution indicated in below table.

Faults	Diagnosis and solution
SPI Fault	<p>SPI communication fault</p> <ul style="list-style-type: none"> • Disconnect PV+ , PV- and battery, reconnect them. • Or seek help from us, if can not go back to normal state.
SCI Fault	<p>SCI communication fault</p> <ul style="list-style-type: none"> • Disconnect PV+ , PV- and battery, reconnect them. • Or seek help from us, if can not go back to normal state.
CAN1 Fault	<p>CAN communication fault</p> <ul style="list-style-type: none"> • Disconnect PV+ , PV- and battery, reconnect them. • Or seek help from us, if can not go back to normal state.
PV Config Fault	<p>PV Connection Setting Fault</p> <ul style="list-style-type: none"> • Resetting the PV connection • Or seek help from us, if can not go back to normal state.
Inv EEPROM Fault	<p>Inverter EEPROM fault</p> <ul style="list-style-type: none"> • Disconnect PV+ , PV- and battery, reconnect them. • Or seek help from us, if can not go back to normal state.
Relay Fault	<p>Relay Fault</p> <ul style="list-style-type: none"> • Disconnect PV+ , PV- and battery, reconnect them. • Or seek help from us, if can not go back to normal state.
Sample Fault	<p>The detection circuit Fault</p> <ul style="list-style-type: none"> • Disconnect PV+ , PV- and battery, reconnect them. • Or seek help from us, if can not go back to normal state.
RCD Fault	<p>Residual Current Device Fault</p> <ul style="list-style-type: none"> • Check the impedance of DC input and AC output. • Disconnect PV+ , PV- and battery, reconnect them. • Or seek help from us, if can not go back to normal state.
Fan1 Fault	<p>Fan Device Fault</p> <ul style="list-style-type: none"> • Disconnect PV+ , PV- and battery, reconnect them. • Check if the fan is stopped by dust or other foreign. • Or seek help from us, if can not go back to normal state.
Fan2 Fault	

Faults	Diagnosis and solution
AC HCT Fault	AC Current Sensor Fault <ul style="list-style-type: none"> • Disconnect PV+ , PV- and battery, reconnect them. • Or seek help from us, if can not go back to normal state.
OverLoad Fault	Over Load in EPS Mode. <ul style="list-style-type: none"> • Turn off high power device , press “ESC” to restart the inverter. • Or seek help from us, if can not go back to normal state.
EPS OCP Fault	Over Current in EPS Mode. <ul style="list-style-type: none"> • Make sure the load power is within the EPS power range. • Check if any nonlinear load is connect on the EPS. Remove this load to check if can recover. • Or seek help from us, if can not go back to normal state.
DCI Device Fault	DCI Device Fault <ul style="list-style-type: none"> • Disconnect PV+ , PV- and battery, reconnect them. • Or seek help from us, if can not go back to normal state.
EPS Relay Fault	EPS Relay Fault <ul style="list-style-type: none"> • Disconnect PV+ , PV- , grid and battery, reconnect them. • Or seek help from us, if can not go back to normal state.
TZ Protect Fault	Over current Fault. <ul style="list-style-type: none"> • Wait for a while to check if go back to normal status. • Disconnect PV+ , PV- and battery, reconnect them. • Or seek help from us, if can not go back to normal state.
Grid Lost Fault	Grid is Lost. <ul style="list-style-type: none"> • System will reconnect if the utility is back to normal. • Or seek help from us.
Grid Volt Fault	Grid Voltage Out of Range <ul style="list-style-type: none"> • System will reconnect if the utility is back to normal. • Or seek help from us.
Grid Freq Fault	Grid Voltage out of range <ul style="list-style-type: none"> • System will reconnect if the utility is back to normal. • Or seek help from us.
PLL Lost Fault	The Grid is Not Good. <ul style="list-style-type: none"> • System will reconnect if the utility is back to normal. • Or seek help from us.
Bus Volt Fault	Bus Voltage out of Normal Range. <ul style="list-style-type: none"> • Disconnect PV+ , PV- and battery, reconnect them. • Check if the PV input is within the range of the inverter. • Or seek help from us, if can not go back to normal state.
AC5M Volt Fault	The grid's voltage is out of range for the last 5 Minutes. <ul style="list-style-type: none"> • The system will back to normal if the grid is back • Or seek for help from us.
Inv OCP Fault	Inverter over current protection fault <ul style="list-style-type: none"> • Wait for a while to check if back to normal. • Or seek for help from us.

Faults	Diagnosis and solution
PV Volt Fault	PV Voltage Fault <ul style="list-style-type: none"> • Check the output of the PV voltage. • Or seek for help from us.
AC10M Volt Fault	The grid's Voltage is out of range for the last 10 minutes. <ul style="list-style-type: none"> • The system will back to normal if the grid is back • Or seek for help from us.
Isolation Fault	Isolation Fault <ul style="list-style-type: none"> • Check the connection of the inverter. • Or seek for help from us.
Temp Over Fault	Temperature over the limitation <ul style="list-style-type: none"> • Check if the fan is running normally. • Check if the environment temperature is over limitation.\ • Or seek help from us.
Fan1 Speed Fault	Fan speed out of the normal range. <ul style="list-style-type: none"> • Check if the fan is stopped by dust or other foreign. • Or seek help from us, if can not go back to normal state.
Fan2 Speed Fault	
C1 Can Fault	The battery group's can communication fault. <ul style="list-style-type: none"> • Reconnect the charger communication cable. • Or seek help from us.
C1 Temp High	The battery charger is over temperature. <ul style="list-style-type: none"> • Check if the air ducting of the charger is blocked. • Improve the working environment or reduce the charging or discharging current. • Or, Seek help from us.
C1 FAN Fault	The fan of the charger is broken. <ul style="list-style-type: none"> • Check if the fan is working normally. • Check if anything blocking the fan • Or, Seek help from us.
C1 TZ Fault	The protection of the charger fault. <ul style="list-style-type: none"> • Wait for a while to check if back to normal. • Or, Seek help from us.
C1 EEPROM Fault	The charger's EEPROM fault. <ul style="list-style-type: none"> • Wait for a while to check if back to normal. • Or, Seek for help from us.
C1 HCT1 Fault	The charger's current detection fault. <ul style="list-style-type: none"> • Reconnect the charger. • Or, Seek for help from us.
C1 HCT2 Fault	
C1 Bus OVP	The Bus voltage of the charger over limit. <ul style="list-style-type: none"> • Wait for a while to check if back to normal. • Or, Seek for help from us.
C1 Temp Low	The charger is under temperature <ul style="list-style-type: none"> • Improve the working environment of the charger. • Or, Seek for help from us.

Faults	Diagnosis and solution
C1 Boost OVP	<p>The Boost voltage of the charger over limit.</p> <ul style="list-style-type: none"> • Wait for a while to check if back to normal. • Or. Seek for help from us.
C1 Bat OVP	<p>The battery voltage is over limit.</p> <ul style="list-style-type: none"> • Wait for a while to check if back to normal. • Or, Seek for help from us.
C1 Charger OCP	<p>The charger is over current protected.</p> <ul style="list-style-type: none"> • Wait for a while to check if back to normal. • Or, Seek help from us.
C1 Boost OCP	<p>The boost current of the charger is over limit.</p> <ul style="list-style-type: none"> • Wait for a while to check if back to normal. • Or, Seek help from us.
CT Fault	<p>The CT or the meter is not connected well.</p> <ul style="list-style-type: none"> • Check the connection of the CT or the meter. • Or, Seek help from us.
RC Fault	<p>DCI over current protection Fault.</p> <ul style="list-style-type: none"> • Wait for a while to check if back to normal. • Or seek for help from us.
DCI OCP Fault	<p>DCI over current protection Fault.</p> <ul style="list-style-type: none"> • Wait for a while to check if back to normal. • Or seek for help from us.
Other device Fault	<p>Other device fault.</p> <ul style="list-style-type: none"> • Turn off the PV, battery and grid , reconnect them. • Or seek for help from us if can not back to normal.
SW OCP Fault	<p>Over current fault detected by software.</p> <ul style="list-style-type: none"> • Turn off the PV, battery and grid , reconnect them. • Or seek for help from us if can not back to normal.
Dm9000 Fault	<p>Network DSP fault.</p> <ul style="list-style-type: none"> • Turn off the PV, battery and grid , reconnect them. • Or seek for help from us if can not back to normal.
RTC Fault	<p>RTC Fault</p> <ul style="list-style-type: none"> • Turn off the PV, battery and grid , reconnect them. • Or seek for help from us if can not back to normal.
Mgr EEPROM Fault	<p>Manager EEPROM Fault.</p> <ul style="list-style-type: none"> • Turn off the PV, battery and grid , reconnect them. • Or seek for help from us if can not back to normal.

Faults	Diagnosis and solution
Mgr CAN Fault	<p>Manager CAN Fault</p> <ul style="list-style-type: none"> • Turn off the PV, battery and grid , reconnect them. • Or seek for help from us if can not back to normal.
C1 SPI Fault	<p>Charge can communication fault.</p> <ul style="list-style-type: none"> • Turn off the PV, battery and grid , reconnect them. • Or seek for help from us if can not back to normal.
C1 TZ Fault	<p>Charge over current detected by hardware.</p> <ul style="list-style-type: none"> • Turn off the PV, battery and grid , reconnect them. • Or seek for help from us if can not back to normal.
C1 FAN Fault	<p>Charge FAN fault.</p> <ul style="list-style-type: none"> • Check if the fan is blocked . • Or seek for help from us if can not back to normal.
C1 sample Fault	<p>Charge sample fault.</p> <ul style="list-style-type: none"> • Turn off the PV, battery and grid , reconnect them. • Or seek for help from us if can not back to normal.

If your inverter's information panel is not displaying a Fault light, check the following list to make sure that the present state of the installation allows proper operation of the unit.

- Is the inverter located in a clean, dry, and adequately ventilated place?
- Have the DC input breakers been opened?
- Are the cables adequately sized and short enough?
- Are the input and output connections and wiring in good condition?
- Are the configurations settings correct for your particular installation?
- Are the display panel and the communications cable properly connected and undamaged?

Contact SolaX Customer Service for further assistance. Please be prepared to describe details of your system installation and provide the model and serial number of the unit.

8.2 Routine Maintenance

• Inverter

Inverters need to be checked every 12 months . (once per year)

Clean the housing with a dry cloth and check that there is no airflow obstruction. Remove any dust build-up from the locations as indicated. Check the inverter and the cables for visible external damage on regular basis.



WARNING!

Clean the airflow holes inside the housing, and cut off the power from the inverter by decommissioning or by using a bypass switch. Internal cleaning is only to be carried out by certified persons. Contact your installer/dealer if you find any defects. Do not perform any repair work by yourself.

- **Battery**

The X-hybrid series inverter is compatible with both lead-acid and lithium battery. Either type of the battery needs to be maintained every month /quarter/ year according to different types and requirement of the battery. If the capacity of the battery decreased to lower than 80% of the rated capacity, the battery should be replaced.

**NOTE !**

The chapter is only for reference. The exact maintenance should be according to the guide provided by the battery manufacture.

9 Decommissioning

9.1 Dismantling the Inverter

- Disconnect the inverter from DC input and AC output.
- Disconnect battery wiring.
- Wait for 5 minutes for de-energizing.
- Disconnect communication and optional connection wiring.
- Remove the inverter from the bracket.

9.2 Packaging

If possible, please pack the inverter with the original packaging. If it is no longer available, you can also use an equivalent carton that meets the following requirements.

- Suitable for loads more than 25 kg.
- With handle.
- Can be fully closed.

9.3 Storage

Store the inverter in dry place where ambient temperatures are always between -20 °C - +60 °C.

9.4 Disposal

When the inverter or other related components need to be disposed. Have it carried out according to local waste handling regulations. Please be sure to deliver wasted inverters and packing materials to certain site, where can assist relevant department to dispose and recycle.



SolaX Power Co., Ltd.

No.288 Shizhu Road, Tonglu Economic Development Zone,
Tonglu City, Zhejiang province, China.

Tel: +86 0571-56260011

E-mail: info@solaxpower.com

www.solaxpower.com

614.00036.00