

Operating Manual UFR1001E

updated: 2021-11-29 /Um
from Firmware: 0-16

- NA-protection according to VDE-AR-N 4105:2011+2018-11, power generators at the low voltage grid, TAR medium voltage VDE-AR-N 4110:2018-11 and TAR high voltage VDE-AR-N 4120:2018-11
- for use in power generators at the medium voltage grid
- with selectable vector shift detection and Rate of Change of Frequency (ROCOF,df/dt)



Firmware 0-10:

Default setting program 2 for low voltage VDE-AR-N 4105:2018-11

4 new programs (11-14) for medium voltage according to 4110:2018-11, new 2-stage test-mode in all programs

New Firmware 0-11:

for using integrated switches, the feedback contact monitoring **trEL** in Pr2 can be switched off

New Firmware 0-12:

New default setting Pr11-14 VDE-AR-N 4110:2018-11

New Firmware 0-13:

Switching-on behaviour adjustable **UFon**, easy measurement of disengaging ratio **rUEF**

New Firmware 0-14:

Monitoring of zero voltage U_0 (ANSI 59v0)

Program 10 for Austria according to TOR producers type A, B, C, D

Program 16 for Belgium according to Synergrid C10 / C11

New Firmware 0-15:

Function ROCOF revised

New factory settings in program Pr16 for Belgium according to Synergrid C10 / C11

New Firmware 0-16:

New factory settings in Pr15, NA/EEA-NE7 CH 2020

(Display of the firmware version: **Info** → **Fnr** or press "Set" for >10s)

Certificates see:

<https://www.ziehl.com/en/products/detail/UFR1001E-54>

Table of contents

1	General Notes	4
2	Display and controls	4
3	Default settings and firmware version, VDE-AR-N 4105 + BDEW	6
4	Default settings and firmware version, VDE-AR-N 4110 + 4120:2018-11	8
5	Default settings and firmware version, TOR Erzeuger Typ A,B,C,D, VSE/EE A-CH 2014, G98(83/2)+G99(G59/3), Synergrid C10 / C11	10
6	Application and brief description	12
7	Summary of the functions	12
8	Connection diagrams	13
1.1	1x PV, 1x section switch (VDE-AR-N 4105:2018-11)	13
1.2	1x PV, 2x section switch (VDE-AR-N 4105:2011)	14
1.3	Multiple PV with section switch and with a series-switched NC's as feedback contacts	15
1.4	Multiple PV with section switch and with a parallel-switched closing contacts as feedback	16
1.5	1x PV, 1x section switch with nc/normally closed contacts (medium voltage VDE-AR-N 4110:2018-11 / high voltage VDE-AR-N 4120:2018-11).....	17
1.6	Using integrated switches of PV and battery inverters according to DIN EN 62109 (VDE 0126-4)	18
1.7	Generator operation, suppression of the feedback contacts.....	19
9	Important information	20
10	Assembly	20
11	Detailed description	21
1.8	Description of the connections	21
1.9	Functional characteristics.....	22
12	Commissioning	23
1.10	Program setup	23
1.11	Control chart Pr 2...6 and Pr 10...23.....	24
1.12	Control chart Pr 1 and Pr 7.....	25
1.13	Description of the parameters	26
1.14	Display mode (last decimal point off).....	27
1.15	Menu mode (last decimal point on)	27
1.16	Configuration mode (last decimal point flashes).....	27
1.17	Switching conditions	28
1.18	Disengaging ratio	28
1.19	Monitoring of zero voltage.....	28
1.20	Test mode (timekeeping only activated and connected feedback contacts)	29
1.21	Alarm counter	29
1.22	Cumulative alarm time (display in hours).....	29
1.23	Alarm memory.....	30
1.24	Standby counter and standby time	30
1.25	Code lock.....	30
1.26	Sealing.....	31
1.27	Simulation	31
1.28	Possible indications in display.....	32
13	Technical Data	33

14	Troubleshooting and measures	35
15	Maintenance and repair	36
16	Construction form V6	36
17	Disposal.....	36
18	Adjustment values table VDE-AR-N 4105:2011, Low Voltage Pr 1+7	37
19	Adjustment values table BDEW June 2008, acc 3.2.3.3-1, Medium Voltage Pr 3-6.....	37
20	Adjustment values table VDE-AR-N 4105:2018-11, Low Voltage 6. table 2, Pr 2	38
21	Adjustment values (VDE-AR-N 4110:2018-11 Medium Voltage / VDE-AR-N 4120:2018-11 High Voltage) higher protection Pr 11+12	38
22	Adjustment values VDE-AR-N 4110:2018-11, Medium Voltage Unit Protection Pr 13+14	39

1 General Notes

Compliance with the following instructions is mandatory to ensure the functionality and safety of the product. If the following instructions given especially but not limited for general safety, transport, storage, mounting, operating conditions, start-up and disposal / recycling are not observed, the product may not operate safely and may cause a hazard to the life and limb of users and third parties. Deviations from the following requirements may therefore lead both to the loss of the statutory material defect liability rights and to the liability of the buyer for the product that has become unsafe due to the deviation from the specifications.

2 Display and controls

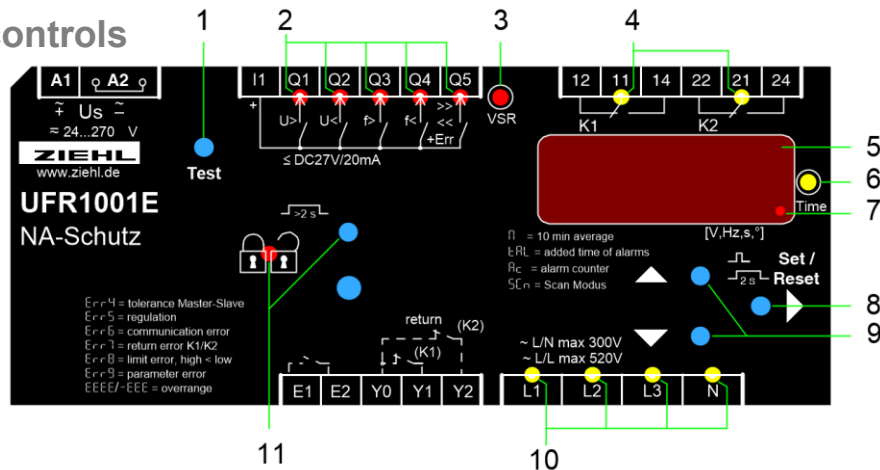

1 Test button

Press briefly	Display test-menu Relay K1 ($\leq 5\leq 1$) or relay K2 ($\leq 5\leq 2$) can be tested independently. (3min without a button is pressed = go back to the normal mode)
---------------	---

2 LEDs frequency / voltage limit value undercut / exceeded (red)

On, \overline{RL} or $RL \overline{\Pi}$	Limit value undercut / exceeded
FLASHES, \overline{RL} or $RL \overline{\Pi}$	Reset delay Δt counting down

3 LED vector surge (VSR, red)

ON, \overline{RL}	Threshold value for vector shift exceeded
FLASHES, \overline{RL}	Reset delay Δt counting down

4 LEDs relay status (yellow)

OFF	Relay is released
ON	Relay operating

5 Digital display 4-digits (red)

Depending on program, display of current voltage, frequency, vector shift, average value	
Displays the alarm signals, e.g. \overline{RL} , $RL \overline{\Pi}$	
Displays the errors with error code e.g. $Err9$	

6 LED Time (yellow)

ON	A time is displayed
FLASHES	Function $rUEF$ active

7 Last decimal point (red)

OFF	Display mode
Illuminated	Menu mode
Flashes	Configuration mode

8 Set/Reset key (in display mode, normal state)

Press briefly	Display of next measured value / alarm counter
Press for > 2 s	Reset, quit error messages
Press for > 4 s	Displays the program, e.g. $Pr 1$
Press for > 10 s	Displays the software version, e.g. $0-05$

9 Up / Down key (in display mode, normal state)

Press briefly	Change to the menu mode, display of alarm memory (Down) / cumulative time of alarms, standby counter, standby time (Up), pushing Set button for ≥ 2 s resets the stored values
Press for > 2 s	Display of MAX (Up) / MIN (Down) - measured values, additional pushing of Set button for ≥ 2 s deletes the stored values

10 LEDs measurement allocation (yellow)

LEDs	Measured value
Lx and N ON	Voltage value (L1 against N, L2 against N, L3 against N)
Lx and Ly ON	Voltage value (L1 against L2, L2 against L3, L1 against L3)
Lx FLASHING quickly	Vector surge (L1, L2, L3)
L1 FLASHING	Frequency

11**Sealable button + LED**  

Press for > 2 s	Lock / Unlock
 LED red	Settings and simulation mode are locked, While attempting to set, Loc is displayed for 3s
LED green	Setting and simulation enabled

3 Default settings and firmware version, VDE-AR-N 4105 + BDEW

When changing programs, all parameters are reset to the default settings.

Menu	Parameter / Unit		Default settings 							Users Data
			Low voltage VDE-AR-N 4105:			Medium voltage BDEW				
			2011	2018	2011					
			3 AC +N 230V	3 AC +N 230V	2/1 AC +N 230V	3 AC +N 57,7V	3 AC 100V	3/2/1AC+ N 230V	3 AC 400V	
	Pr1	Pr2 *	Pr3	Pr4	Pr5	Pr6				
59.S2 59>S2	U ⁻	Alarm on/off	-	on	-	on	on	on	on	
	U ⁻	Overvoltage	V	-	287	-	66.4	115	264	458
	H ⁻	Hysteresis	V	-	35.0	-	1.0	1.0	3.0	3.0
	dRL	Response time	s	-	0.10	-	0.10	0.10	0.10	0.10
	doF	OFF-delay	s	-	60	-	60	60	60	60
59.S1 59>S1	U ⁻	Alarm on/off	on	oFF	on	on	on	on	on	
	U ⁻	Overvoltage	V	264	264	264	62.3	108	249	430
	H ⁻	Hysteresis	V	5.0	12.0	5.0	1.0	1.0	3.0	3.0
	dRL	Response time	s	0.10	0.10	0.10	60.0	60.0	60.0	60.0
	doF	OFF-delay	s	60	60	60	60	60	60	60
59-Av	U ⁿ	Alarm on/off	on	on	on	oFF	oFF	oFF	oFF	
	U ⁿ	Overvoltage	V	253	253 ³	253	63.5	110	253	438
	H ⁿ	Hysteresis	V	3.0	5.0	3.0	1.0	1.0	3.0	3.0
	dRL	Response time	s	0.10	0.10	0.10	0.10	0.10	0.10	0.10
	doF	OFF-delay	s	60	60	60	60	60	60	60
27.S1 27<S1	U ₋	Alarm on/off	on	on	on	on	on	on	on	
	U ₋	Undervoltage	V	184	184	184	46.2	80.0	184	318
	H ₋	Hysteresis	V	5.0	12.0	5.0	1.0	1.0	3.0	3.0
	dRL	Response time	s	0.10	3.00 ³	0.10	2.70	2.70	2.70	2.70
	doF	OFF-delay	s	60	60	60	60	60	60	60
27.S2 27<S2	U ₋	Alarm on/off	-	on	-	oFF	oFF	oFF	oFF	
	U ₋	Undervoltage	V	-	103	-	26.0	45.0	104	180
	H ₋	Hysteresis	V	-	93.0	-	1.0	1.0	2.0	2.0
	dRL	Response time	s	-	0.30 ³	-	0.30	0.30	0.30	0.30
	doF	OFF-delay	s	-	60	-	60	60	60	60
81.S2 81>S2	F ⁻	Alarm on/off	-	oFF	-	oFF	oFF	oFF	oFF	
	F ⁻	Overfrequency	Hz	-	52.50	-	51.50	51.50	51.50	51.50
	H ⁻	Hysteresis	Hz	-	2.40 ²	-	1.45 ¹	1.45 ¹	1.45 ¹	1.45 ¹
	dRL	Response time	s	-	0.10	-	0.10	0.10	0.10	0.10
	doF	OFF-delay	s	-	60	-	60	60	60	60
81.S1 81>S1	F ⁻	Alarm on/off	on	on	on	on	on	on	on	
	F ⁻	Overfrequency	Hz	51.50	51.50	51.50	51.50	51.50	51.50	51.50
	H ⁻	Hysteresis	Hz	1.45 ¹	1.40 ²	1.45 ¹	1.45 ¹	1.45 ¹	1.45 ¹	1.45 ¹
	dRL	Response time	s	0.10	0.10	0.10	0.10	0.10	0.10	0.10
	U ⁻	Alarm on/off	s	60	60	60	60	60	60	60

* factory preset

¹ = Autohysteresis 50,05 Hz

² = Autohysteresis 50,10 Hz

³ = Parameter can be changed without unlocking code lock (Pr2 only)

Display of the program: I n F o → Pr or when switching on

Display of the firmware version: I n F o → F n r

Menu	Parameter / Unit		Default settings 							Users Data			
			Low voltage VDE-AR-N 4105:			Medium voltage BDEW							
			2011	2018	2011	3 AC +N 230V	3 AC +N 230V	2/1 AC +N 230V	3 AC +N 57,7V		3 AC 100V	3/2/1AC+ N 230V	3 AC 400V
			Pr1	Pr2 *	Pr7	Pr3	Pr4	Pr5	Pr6				
F_- 81.S1 81<S1	F_-	Alarm on/off	on	on	on	on	on	on	on	on			
	F_-	Underfrequency	Hz	47.50	47.50	47.50	47.50	47.50	47.50	47.50			
	H_-	Hysteresis	Hz	1.00	0.10	1.00	1.00	1.00	1.00	1.00			
	dRL	Response time	s	0.10	0.10	0.10	0.10	0.10	0.10	0.10			
	doF	OFF-delay	s	60	60	60	60	60	60	60			
F_-- 81.S2 81<S2	F_--	Alarm on/off	-	oFF	-	oFF	oFF	oFF	oFF	oFF			
	F_--	Underfrequency	Hz	-	47.00	-	47.50	47.50	47.50	47.50			
	H_--	Hysteresis	Hz	-	0.60	-	1.00	1.00	1.00	1.00			
	dRL	Response time	s	-	0.10	-	0.10	0.10	0.10	0.10			
	doF	OFF-delay	s	-	60	-	60	60	60	60			
UFon	UFon	Switching conditions	oFF	oFF	oFF	oFF	oFF	oFF	oFF	oFF			
UonF	UonF	on/off	oFF	oFF	oFF	oFF	oFF	oFF	oFF	oFF			
	UonF	voltage	V	46.0	46.0	46.0	20.0	20.0	46.0	46.0			
u5r 78	u5r	Alarm on/off	5tbY	5tbY	5tbY	5tbY	5tbY	5tbY	5tbY	5tbY			
	u5r	Vector shift	°	10.0	10.0	10.0	10.0	10.0	10.0	10.0			
	doF	OFF-delay	s	3	3	3	3	3	3	3			
	dEon	Suppression time	s	2	2	2	3	3	3	3			
	u5r	Number of phases		3Ph	3Ph	3Ph	3Ph	3Ph	3Ph	3Ph			
rocF 81r	rocF	Alarm on/off	oFF	oFF	oFF	oFF	oFF	oFF	oFF	oFF			
	dFdt	delta f / delta t	Hz/s	0.800	2.000	0.800	0.800	0.800	0.800	0.800			
	PEr	periods		20	20	20	20	20	20	20			
	dRL	Response time	s	0.10	0.10	0.10	0.10	0.10	0.10	0.10			
	doF	OFF-delay	s	60	60	60	60	60	60	60			
U-0 59v0	U-0	Alarm on/off	oFF	oFF	oFF	oFF	oFF	oFF	oFF	oFF			
	U-0	Zero voltage	V	46.0	46.0	46.0	46.0	80.0	46.0	80.0			
	H-0	Hysteresis	V	10.0	10.0	10.0	10.0	10.0	10.0	10.0			
	dRL	Response time	s	1.50	1.50	1.50	1.50	1.50	1.50	1.50			
	doF	OFF-delay	s	60	60	60	60	60	60	60			
rEL	ErEL	Response time Yx	s	5.0	5.0 ³	5.0	oFF	oFF	oFF	oFF			
	doFA	Mode		ind	ind	ind	ind	ind	ind	ind			
	doFA	Off-delay all	s	0	0	0	0	0	0	0			
ddi	ddi	Display delay	s	0.5	0.5	0.5	0.5	0.5	0.5	0.5			
	di t	Display duration 5Ln	s	3.5	3.5	3.5	3.5	3.5	3.5	3.5			
Si	U	Voltage	V	230	230	230	57.7	100	230	400			
	F	Frequency	Hz	50.00	50.00	50.00	50.00	50.00	50.00	50.00			
	u5r	Vector shift	°	0.0	0.0	0.0	0.0	0.0	0.0	0.0			
CodE	Pin	Pincode		504	504	504	504	504	504	504			
	CodE	on / off		oFF	on	oFF	oFF	oFF	oFF	oFF			
InFo	Fnr	Firmware version		0- 16	0- 16	0- 16	0- 16	0- 16	0- 16	0- 16			
	Snr	Serial number		xxxx	xxxx	xxxx	xxxx	xxxx	xxxx	xxxx			
	h	Operating hours	h	xxxx	xxxx	xxxx	xxxx	xxxx	xxxx	xxxx			
	Err	Error counter		xxx	xxx	xxx	xxx	xxx	xxx	xxx			
	Pr	Program		1	2	7	3	4	5	6			

* factory preset

Display of the program: InFo → Pr or when switching on

Display of the firmware version: InFo → Fnr

³ = Parameter can be changed without unlocking code lock (Pr2 only)

4 Default settings and firmware version, VDE-AR-N 4110 + 4120:2018-11

When changing programs, all parameters are reset to the default settings.

Menu	Parameter / Unit		Default settings 				Users Data	
			Medium voltage VDE-AR-N 4110:2018-11		High voltage VDE-AR-N 4120:2018-11			
			3 AC +N 57,7V Pr 11	3 AC 100V Pr 12	3/2/1AC+ N 230V Pr 13	3 AC 400V Pr 14		
59.S2 59>S2	U ⁻⁻⁻	Alarm on/off	on	on	on	on		
	U ⁻⁻⁻	Overvoltage	V	69.2	120	287	498	
	H ⁻⁻⁻	Hysteresis	V	1.0	1.0	3.0	3.0	
	dAL	Response time	s	0.30	0.30	0.10	0.10	
	doF	OFF-delay	s	60	60	60	60	
59.S1 59>S1	U ⁻	Alarm on/off	on	on	oFF	oFF		
	U ⁻	Overvoltage	V	63.5	110	249	430	
	H ⁻	Hysteresis	V	1.0	1.0	3.0	3.0	
	dAL	Response time	s	180.0	180.0	60.0	60.0	
	doF	OFF-delay	s	60	60	60	60	
59-Av	U [∩]	Alarm on/off	oFF	oFF	oFF	oFF		
	U [∩]	Overvoltage	V	63.5	110	253	438	
	H [∩]	Hysteresis	V	1.0	1.0	3.0	3.0	
	dAL	Response time	s	0.10	0.10	0.10	0.10	
	doF	OFF-delay	s	60	60	60	60	
27.S1 27<S1	U ₋	Alarm on/off	on	on	on	on		
	U ₋	Undervoltage	V	46.2	80.0	184	318	
	H ₋	Hysteresis	V	9.0	15.5	35.0	61.0	
	dAL	Response time	s	2.70	2.70	1.00	1.00	
	doF	OFF-delay	s	60	60	60	60	
27.S2 27<S2	U ₋₋	Alarm on/off	oFF	oFF	on	on		
	U ₋₋	Undervoltage	V	26.0	45.0	104	179	
	H ₋₋	Hysteresis	V	29.0	50.0	115	180	
	dAL	Response time	s	0.30	0.30	0.30	0.30	
	doF	OFF-delay	s	60	60	60	60	
81.S2 81>S2	F ⁻⁻⁻	Alarm on/off	oFF	oFF	on	on		
	F ⁻⁻⁻	Overfrequency	Hz	51.50	51.50	52.50	52.50	
	H ⁻⁻⁻	Hysteresis	Hz	1.40 ²	1.40 ²	2.40 ²	2.40 ²	
	dAL	Response time	s	0.10	0.10	0.10	0.10	
	doF	OFF-delay	s	60	60	60	60	
81.S1 81>S1	F ⁻	Alarm on/off	oFF	oFF	on	on		
	F ⁻	Overfrequency	Hz	51.50	51.50	51.50	51.50	
	H ⁻	Hysteresis	Hz	1.40 ²	1.40 ²	1.40 ²	1.40 ²	
	dAL	Response time	s	5.40	5.40	5.00	5.00	
	U ⁻⁻⁻	Alarm on/off	s	60	60	60	60	

² = Autohysteresis 50,10 Hz

Display of the program: **I nF o** → **Pr** or when switching on

Display of the firmware version: **I nF o** → **Fnr**

Menu	Parameter / Unit		Default settings Medium voltage  VDE-AR-N 4110:2018-11 High Voltage VDE-AR-N 4120:2018-11				Users Data	
			3 AC +N 57,7V	3 AC 100V	3/2/1AC+ N 230V	3 AC 400V		
			Pr 11	Pr 12	Pr 13	Pr 14		
F_ 81.S1 81<S1	F_	Alarm on/off	oFF	oFF	on	on		
	F_	Underfrequency	Hz	47.50	47.50	47.50	47.50	
	H_	Hysteresis	Hz	2.40 ⁴	2.40 ⁴	2.40 ⁴	2.40 ⁴	
	dRL	Response time	s	0.40	0.40	0.10	0.10	
	doF	OFF-delay	s	60	60	60	60	
F_ 81.S2 81<S2	F_ F_ H_ dRL doF	Alarm on/off Underfrequency Hysteresis Response time OFF-delay	 Hz Hz s s	 47.50 2.40 ⁴ 0.10 60	 47.50 2.40 ⁴ 0.10 60	 47.50 2.40 ⁴ 0.10 60	 47.50 2.40 ⁴ 0.10 60	
	UFon	Switching conditions		oFF	oFF	on	on	
	UonF	UonF	on/off		oFF	oFF	oFF	oFF
		UonF	voltage	V	20.0	20.0	46.0	46.0
	u5r 78	u5r	Alarm on/off		5tb9	5tb9	5tb9	5tb9
u5r		Vector shift	°	10.0	10.0	10.0	10.0	
doF		OFF-delay	s	3	3	3	3	
dEon		Suppression time	s	3	3	3	3	
u5r		Number of phases		3Ph	3Ph	3Ph	3Ph	
rocF 81r	rocF	Alarm on/off		oFF	oFF	oFF	oFF	
	dFdE	delta f / delta t	Hz/s	2.000	2.000	2.000	2.000	
	PER	periods		20	20	20	20	
	dRL	Response time	s	0.10	0.10	0.10	0.10	
	doF	OFF-delay	s	60	60	60	60	
U-0 59v0	U-0	Alarm on/off		oFF	oFF	oFF	oFF	
	U-0	Zero voltage	V	46.0	80.0	46.0	80.0	
	H-0	Hysteresis	V	10.0	10.0	10.0	10.0	
	dRL	Response time	s	1.50	1.50	1.50	1.50	
	doF	OFF-delay	s	60	60	60	60	
rEL	ErEL	Response time Yx	s	oFF	oFF	oFF	oFF	
	doFR	Mode		ind	ind	ind	ind	
	doFR	Off-delay all	s	0	0	0	0	
ddi	ddi	Display delay	s	0.5	0.5	0.5	0.5	
	diE	Display duration SCn	s	3.5	3.5	3.5	3.5	
Si	U	Voltage	V	57.7	100	230	400	
	F	Frequency	Hz	50.00	50.00	50.00	50.00	
	u5r	Vector shift	°	0.0	0.0	0.0	0.0	
CodE	Pin	Pincode		504	504	504	504	
	CodE	on / off		oFF	oFF	oFF	oFF	
InFo	Fnr	Firmware version		0-16	0-16	0-16	0-16	
	Snr	Serial number		xxxx	xxxx	xxxx	xxxx	
	h	Operating hours	h	xxxx	xxxx	xxxx	xxxx	
	Err	Error counter		xxx	xxx	xxx	xxx	
	Pr	Program		11	12	13	14	





⁴ = Autohysteresis 49,90 Hz

Display of the program: InFo → Pr or when switching on

Display of the firmware version: InFo → Fnr

5 Default settings and firmware version, TOR Erzeuger Typ A,B,C,D, VSE/EE A-CH 2014, G98(83/2)+G99(G59/3), Synergrid C10 / C11

When changing programs, all parameters are reset to the default settings.

Menu	Parameter / Unit				Default settings 				
			TOR Erzeuger Typ A,B,C,D**	NA/EEA-NE7 CH 2020	G98(G83/2) + G99(G59/3)				Synergrid C10/C11
			3AC+N 230V	3AC+N 230V	3/2/1A C+N 230V *	3AC 400V *	3AC+N 63,5V *	3AC 110V *	3AC+N 230V
			Pr 10	Pr 15	Pr 20	Pr 21	Pr 22	Pr 23	Pr 16
U ⁻⁻ 59.S2 59>S2	U ⁻⁻ Alarm on/off		on	on	on	on	on	on	on
	U ⁻⁻ Overvoltage	V	264	276	273	476	717	124	264
	H ⁻⁻ Hysteresis	V	133	230	50	50	10	10	50
	dRL Response time	s	0.10	0.10	0.50	0.50	0.50	0.50	0.05
	doF OFF-delay	s	60	60	20	20	20	20	1
U ⁻ 59.S1 59>S1	U ⁻ Alarm on/off		on	oFF	on	on	on	on	on
	U ⁻ Overvoltage	V	255	253	262	456	698	121	253
	H ⁻ Hysteresis	V	43	30	50	50	10	10	50
	dRL Response time	s	600	600	100	100	100	100	100
	doF OFF-delay	s	60	60	20	20	20	20	1
UN ⁻ 59-Av	UN ⁻ Alarm on/off		on	on	oFF	oFF	oFF	oFF	oFF
	UN ⁻ Overvoltage	V	255	253	262	456	658	121	253
	HN ⁻ Hysteresis	V	43	30	50	50	10	10	50
	dRL Response time	s	0.10	0.10	100	100	100	100	100
	doF OFF-delay	s	60	60	20	20	20	20	1
U ₋ 27.S1 27<S1	U ₋ Alarm on/off		on	on	oFF	oFF	oFF	oFF	on
	U ₋ Undervoltage	V	184	184	200	348	502	957	161
	H ₋ Hysteresis	V	115	120	50	50	10	10	50
	dRL Response time	s	100	150	250	250	250	250	150
	doF OFF-delay	s	60	60	20	20	20	20	1
U ₋₋ 27.S2 27<S2	U ₋₋ Alarm on/off		on	on	on	on	on	on	on
	U ₋₋ Undervoltage	V	690	104	184	320	508	880	570
	H ₋₋ Hysteresis	V	126.5	920	50	50	10	10	50
	dRL Response time	s	0.20	0.30	250	250	250	250	0.05
	doF OFF-delay	s	60	60	20	20	20	20	1
F ⁻⁻ 81.S2 81>S2	F ⁻⁻ Alarm on/off		oFF	oFF	on	on	on	on	oFF
	F ⁻⁻ Overfrequency	Hz	5150	5150	5200	5200	5200	5200	5150
	H ⁻⁻ Hysteresis	Hz	140 ²	140 ²	195 ¹	195 ¹	195 ¹	195 ¹	140 ²
	dRL Response time	s	0.10	0.10	0.50	0.50	0.50	0.50	0.05
	doF OFF-delay	s	60	60	20	20	20	20	1
F ⁻ 81.S1 81>S1	F ⁻ Alarm on/off		on	on	oFF	oFF	oFF	oFF	on
	F ⁻ Overfrequency	Hz	5150	5150	5150	5150	5150	5150	5150
	H ⁻ Hysteresis	Hz	140 ²	140 ²	145 ¹	145 ¹	145 ¹	145 ¹	140 ²
	dRL Response time	s	0.10	0.10	900	900	900	900	0.05
	doF OFF-delay	s	60	60	20	20	20	20	1

* Pr 20 ... Pr 23 for 240/416 V rated voltage change settings of: Voltage x (240V / 230 V)

** Pr 10 the ÖVE / ÖNORM E 8001-4-712 can be parameterized by adapting the parameters

¹ = Autohysteresis 50.05 Hz





² = Autohysteresis 50.10 Hz

Display of the program:

Info → Pr or when switching on

Display of the firmware version:

Info → Fnr

Menu	Parameter / Unit				Default settings 				
			TOR Erzeuger Typ A,B,C,D**	NA/EEA-NE7 CH 2020	G98(G83/2) + G99(G59/3)				Synergrid C10/C11
			3AC+N 230V	3AC+N 230V	3AC+N 230V	3AC 400V	3AC+N 63,5V	3AC 110V	3AC+N 230V
			Pr 10	Pr 15	Pr 20	Pr 21	Pr 22	Pr 23	Pr 16
F_ 81.S1 81<S 1	F_ Alarm on/off		on	on	on	on	on	on	on
	F_ Underfrequency	Hz	47.50	47.50	47.50	47.50	47.50	47.50	47.50
	H_ Hysteresis	Hz	0.10	0.10	1.00	1.00	1.00	1.00	2.40
	dRL Response time	s	0.10	0.10	20.0	20.0	20.0	20.0	0.05
	doF OFF-delay	s	60	60	20	20	20	20	1
F_ 81.S2 81<S 2	F_ Alarm on/off		oFF	oFF	on	on	on	on	oFF
	F_ Underfrequency	Hz	47.50	47.50	47.00	47.00	47.00	47.00	47.50
	H_ Hysteresis	Hz	0.10	0.10	1.00	1.00	1.00	1.00	2.40
	dRL Response time	s	0.10	0.10	0.50	0.50	0.50	0.50	0.05
	doF OFF-delay	s	60	60	20	20	20	20	1
UFon	UFon Switching conditions		on	oFF	oFF	oFF	oFF	oFF	oFF
UonF	UonF on/off		oFF	oFF	oFF	oFF	oFF	oFF	oFF
	UonF voltage	V	46.0	16.10	46.0	46.0	20.0	20.0	20.0
uSr 78	uSr Alarm on/off		StbY	StbY	StbY	StbY	StbY	StbY	oFF
	uSr Vector shift	°	10.0	10.0	50.0	50.0	50.0	50.0	7.0
	doF OFF-delay	s	60	3	20	20	20	20	20
	dEon Suppression time	s	2	2	2	2	2	2	2
	uSr Number of phases		3Ph	3Ph	1Ph	1Ph	1Ph	1Ph	3Ph
racF 81r	racF Alarm on/off		oFF	oFF	on	on	on	on	on
	dFdt delta f / delta t	Hz/s	0.800	2.000	1.000	1.000	1.000	1.000	1.000
	PEr periods		20	20	20	20	20	20	8
	dRL Response time	s	0.10	0.10	0.50	0.50	0.50	0.50	0.20
	doF OFF-delay	s	60	60	20	20	20	20	1
U-0 59v0	U-0 Alarm on/off		oFF	oFF	oFF	oFF	oFF	oFF	oFF
	U-0 Zero voltage	V	46.0	46.0	46.0	80.0	46.0	80.0	46.0
	H-0 Hysteresis	V	10.0	10.0	10.0	10.0	10.0	10.0	10.0
	dRL Response time	s	1.50	1.50	1.50	1.50	1.50	1.50	1.50
	doF OFF-delay	s	60	60	60	60	60	60	1
rEL	ErEL Response time Yx	s	oFF	5.0	oFF	oFF	oFF	oFF	oFF
	doFR Mode		ind	ind	ind	ind	ind	ind	ind
	doFR Off-delay all	s	0	0	0	0	0	0	0
ddi	ddi Display delay	s	0.5	0.5	0.5	0.5	0.5	0.5	0.5
	di t Display duration S[n]	s	3.5	3.5	3.5	3.5	3.5	3.5	3.5
Si	U Voltage	V	230	230	230	400	63.5	110	230
	F Frequency	Hz	50.00	50.00	50.00	50.00	50.00	50.00	50.00
	uSr Vector shift	°	0.0	0.0	0.0	0.0	0.0	0.0	0.0
CodE	Pi n Pincode		504	504	504	504	504	504	504
	CodE on / off		oFF	oFF	oFF	oFF	oFF	oFF	oFF
Info	Fnr Firmware version		0- 16	0- 16	0- 16	0- 16	0- 16	0- 16	0- 16
	Snr Serial number		xxxx	xxxx	xxxx	xxxx	xxxx	xxxx	xxxx
	h Operating hours	h	xxxx	xxxx	xxxx	xxxx	xxxx	xxxx	xxxx
	Err Error counter		xxx	xxx	xxx	xxx	xxx	xxx	xxx
	Pr Program		10	15	20	21	22	23	16

** Pr 10 the ÖVE / ÖNORM E 8001-4-712 can be parameterized by adapting the parameters

Display of the program:

Info → Pr or when switching on

Display of the firmware version:

Info → Fnr

6 Application and brief description

The grid- and plant protection device UFR1001E monitors voltage and frequency in plants for own generation of electricity. It complies with the requirements of VDE-AR-N 4105:2018-11, VDE-AR-N 4110:2018-11, VDE-AR-N 4120:2018-11, G59/3, G83/2, ÖVE/ÖNORM E 8001-4-712:2009 and other standards for generators connected to the public grid.

The UFR1001E is a dual-channel device and thus one-fault-proof. The function of the output-relays and of the connected switches can be monitored with feed-back contacts. When a connected switch does not switch off, the UFR does not switch on again. When a switch does not switch on it makes 2 restarts and thus improves availability of monitored plant.

The limits are pre-set according to VDE-AR-N 4105_2011-08, VDE-AR-N 4105:2011-11 and other standards. They can be changed if required and be protected with a code and/or a seal.

With a test-button the function of the connected switches can be tested and their switching-time can be measured.

The standby input allows a remote shutoff e.g. with a RCR.

7 Summary of the functions

- Under and overvoltage monitoring 15...520 V
- Measuring phase-neutral or phase-phase
- Monitoring of under- and overfrequency 45...65 Hz
- Monitoring of quality of voltage (10-minutes-average)
- Monitoring of vector shift 2...65°
- Monitoring of rate of change of frequency (ROCOF, df/dt) 0,100...5,000 Hz/s
- Monitoring of zero voltage U_0
- One-fault-proof with monitoring of connected switches (defeatable when using the integrated switch of pv and battery inverter acc. to DIN EN 62109 (VDE 0126-4))
- 2 automatic restarts at switch-on error
- Passive anti-islanding protection acc. to ch. 6.5.3 and app. D2
- Switching delay adjustable 0.05 ... 300 s
- Switching back delay adjustable 0 ... 6.000 s
- Switching back delay at alarms <3 s: 5 s

Preset values acc. to

- VDE-AR-N 4105:2018-11 (Pr2), VDE-AR-N 4105_2011-08 (Pr1)
- VDE-AR-N 4110 + 4120:2018-11 (PR11-14) and BDEW (Pr 3-6)
- G59/3 and G83/2 for Great Britain
- ÖVE standard for Austria
- VSE/EEA-CH 2014 for Switzerland
- Alarm counter for 100 alarms (trip value, cause and rel. time stamp)
- Record of added times of alarms
- Input for standby with counter and recording of time
- Test button and simulation with measuring of switching-times
- Sealing, all values can be read-out when sealed
- Easy installation and programming with pre-set programs
- Housing for DIN-rail-mount, 105 mm wide, mounting height 66 mm

8 Connection diagrams

1.1 1x PV, 1x section switch (VDE-AR-N 4105:2018-11)

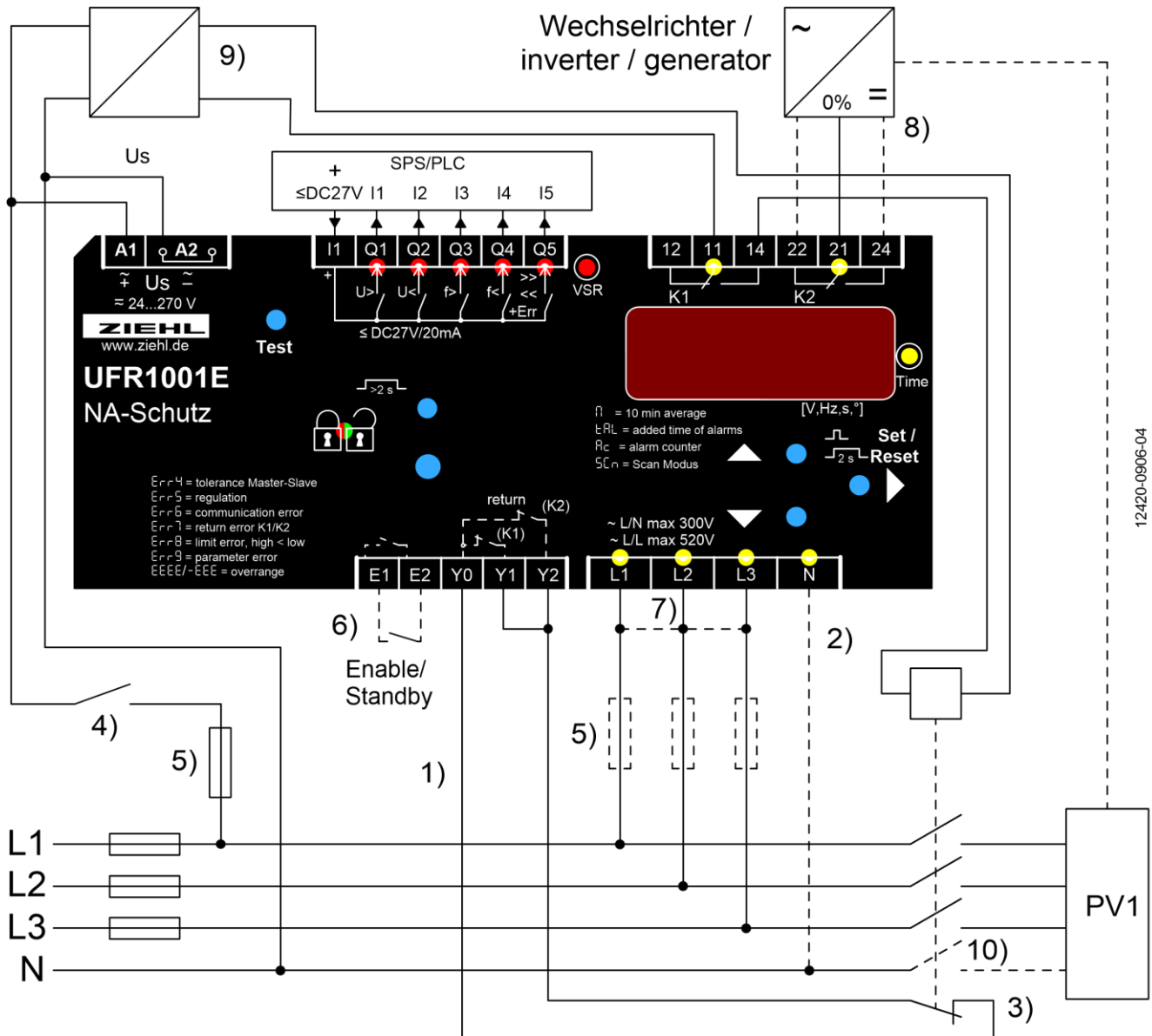

12420-0906-04

- 1) Feedback contacts not connected: set **rEL** → **ErEL** → **off**.
- 2) N connected → only for programs with N
- 3) NC- or NO-contacts can be connected, self-learning when switching on
- 4) Switch off the plant without recording an alarm, e.g. with contact of a ripple control receiver
- 5) Fuses only when line protection necessary, e.g. 16 A
- 6) Contact closed an **u5r** → **5t5t** (default setting) = Standby, K1+2 switched-off (e.g. by ripple control receiver or clock, ...)
 Contact closed and **u5r** → **on** = repressed vector shifts (e.g. when switching on ...),
 contact closed and **u5r** → **4192** = no evaluation of the feedback contacts (e.g. for synchronisation, ...)
- 7) 1 phase Application connect L1-L2-L3, 2 phase Application L1 / L2+L3 (only Pr 5, 7, 10, 13, 20)
- 8) Additional switch-off of self generation plant.
 Single-fault safety: shutdown of the self generation plant e.g. by ripple control input 0% with K2. Use coupling relays for contact multiplication if safe isolation is required.
 This second shutdown path must be tested separately during commissioning. (**5t5t**)
- 9) Power supply / buffering. Switches have to withstand undervoltage for min.3 s (FRT)
- 10) TT-system: switch all line conductors and N, TN-system: only switch line conductor

1.2 1x PV, 2x section switch (VDE-AR-N 4105:2011)

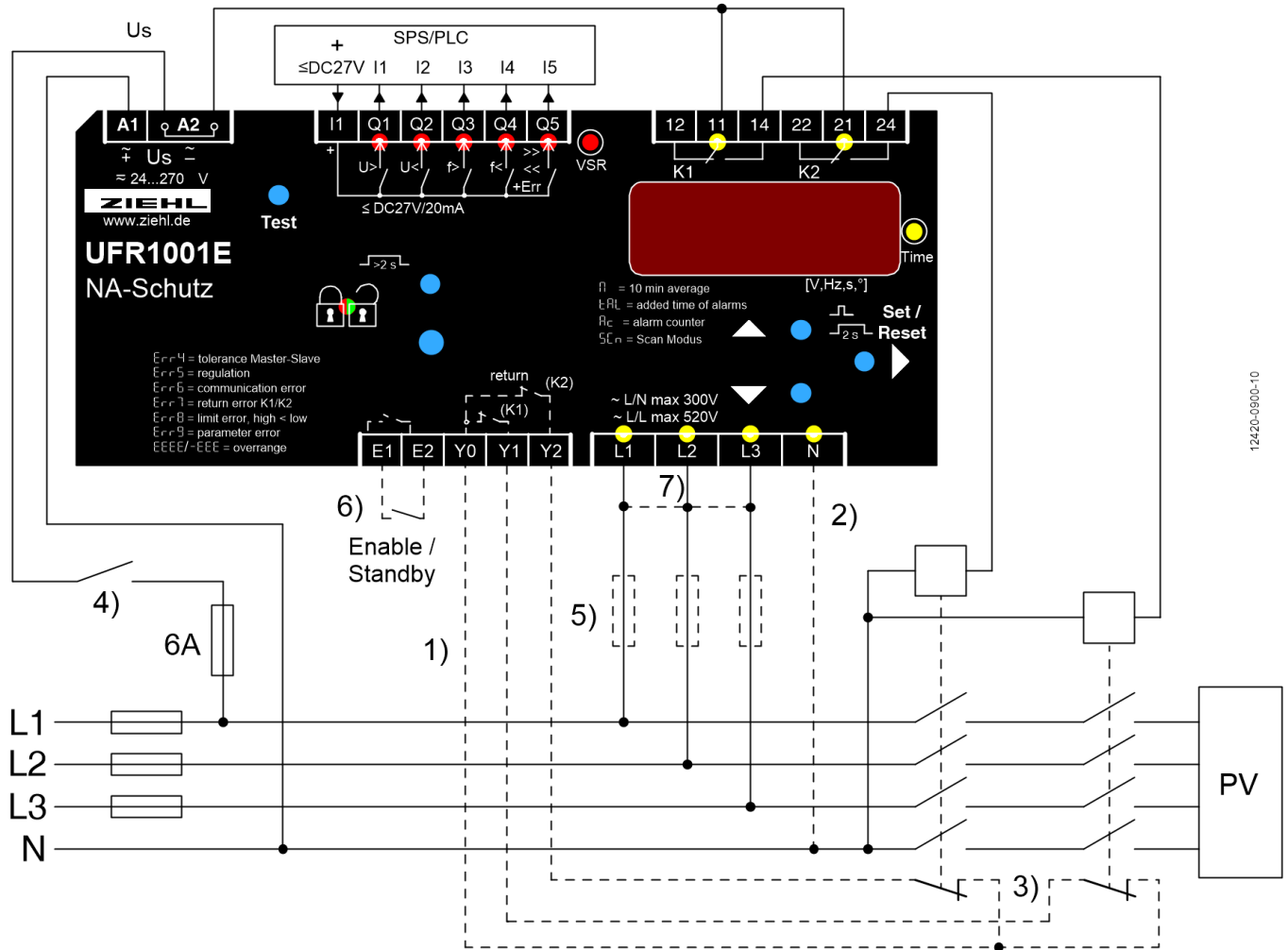

12420-0900-10

- 1) Feedback contacts not connected: set rEL → t_rEL → OFF .
- 2) N connected → only for programs with N
- 3) NC- or NO-contacts can be connected, self-learning when switching on
- 4) Switch off the plant without recording an alarm, e.g. with contact of a ripple control receiver
- 5) Fuses only when line protection necessary, e.g. 3x16A
- 6) Contact closed an $u5r$ → $5tBY$ (default setting) = Standby, K1+2 switched-off (e.g. by ripple control receiver or clock, ...)
 Contact closed and $u5r$ → on = repressed vector shifts (e.g. when switching on ...),
 contact closed and $u5r$ → $Y1Y2$ = no evaluation of the feedback contacts (e.g. for synchronisation, ...)
- 7) 1 phase Application connect L1-L2-L3, 2 phase Application L1 / L2+L3 (only Pr 5, 7, 10, 13, 20)

1.3 Multiple PV with section switch and with a series-switched NC's as feedback contacts (expanded inventory plant)

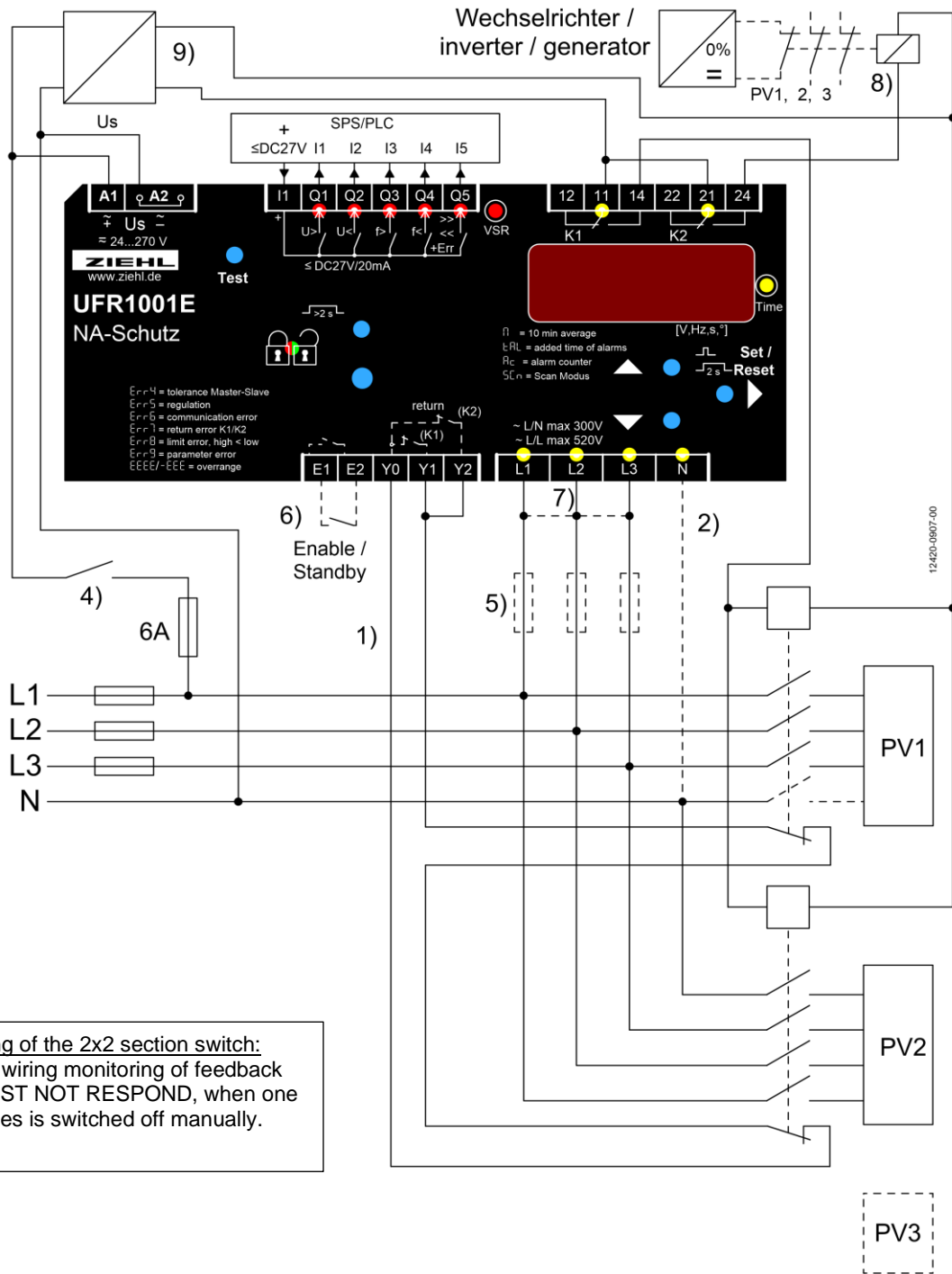

Correct wiring of the 2x2 section switch:
With correct wiring monitoring of feedback contacts MUST NOT RESPOND, when one of the switches is switched off manually.

- 1) Contactor feedback contacts Y1/Y2 not connected set rEL → t_rEL → **off**.
- 2) N connected → only for programs with N
- 4) Switch off the plant without recording an alarm, e.g. with output contact of a ripple control receiver
- 5) Fuses only when line protection necessary, e.g. 3x16A
- 6) Contact closed an $u5r$ → **StBY** (default setting) = Standby, K1+2 switched-off (e.g. by ripple control receiver or clock, ...)
Contact closed and $u5r$ → **on** = repressed vector shifts (e.g. when switching on ...),
contact closed and $u5r$ → **Y12** = no evaluation of the feedback contacts (e.g. for synchronisation, ...)
- 7) 1 phase Application connect L1-L2-L3, 2 phase Application L1 / L2+L3 (only Pr 5, 7, 10, 13, 20)
- 8) Additional switch-off of self generating plant.
Single-fault safety: shutdown of the self generation plant e.g. by ripple control input 0% with K2. Use coupling relays ford contact multiplication of if safe isolation is required.
This second shutdown path must be tested separately during commissioning. (**t5t2**)
- 9) Power supply / buffering. Switches have to withstand undervoltage for min.3 s (FRT)

1.4 Multiple PV with section switch and with a parallel-switched closing contacts as feedback

(expanded inventory plant)

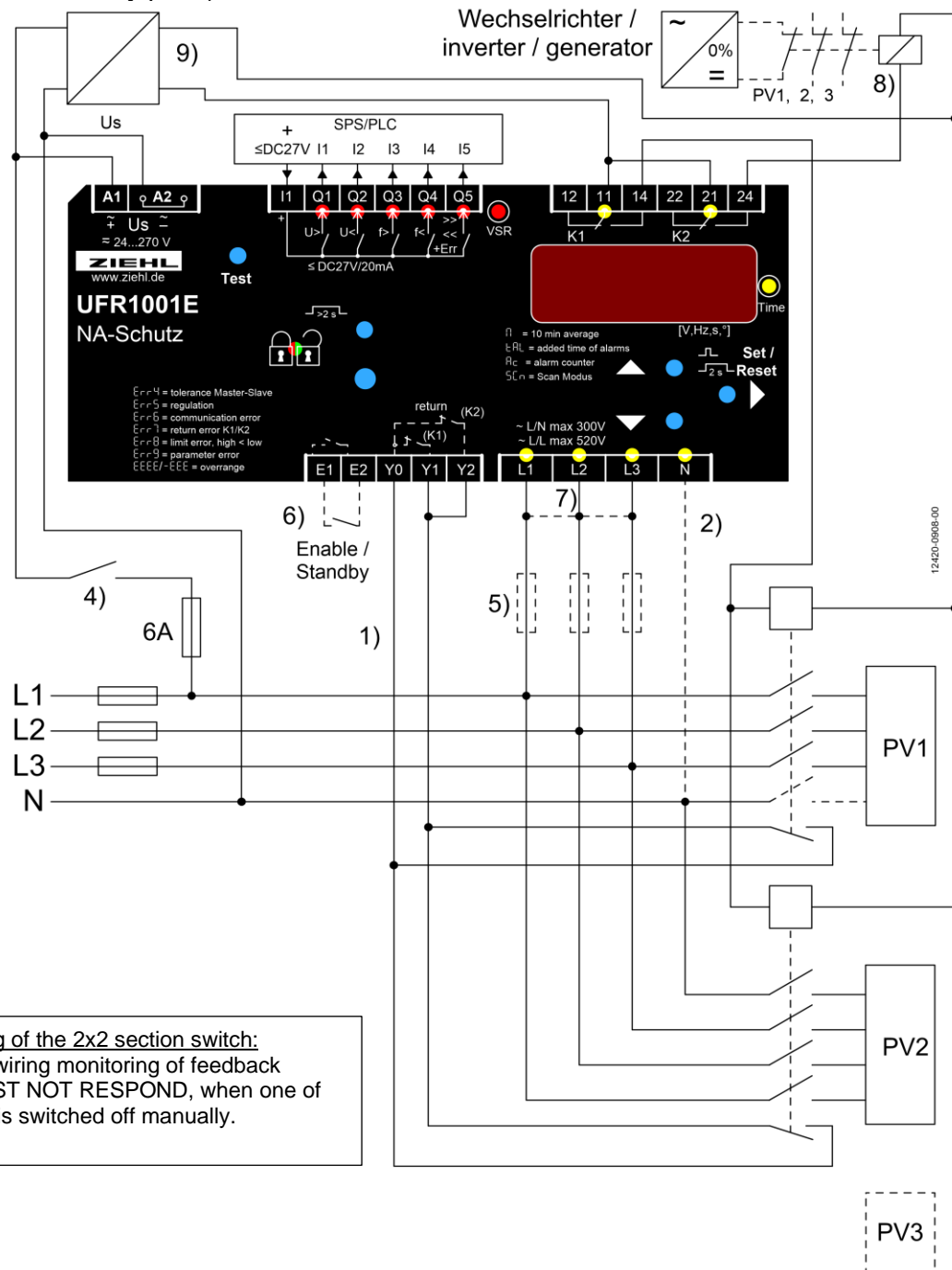

Correct wiring of the 2x2 section switch:
With correct wiring monitoring of feedback contacts MUST NOT RESPOND, when one of the switches is switched off manually.

- 1) Feedback contacts Y1/Y2 not connected set $rEL . \rightarrow t_rEL . \rightarrow off .$
- 2) N connected \rightarrow only for programs with N
- 4) Switch off the plant without recording an alarm, e.g. with output contact of a ripple control receiver
- 5) Fuses only when line protection necessary, e.g. 3x16A
- 6) Contact closed an $u5r . \rightarrow 5t b y .$ (default setting) = Standby, K1+2 switched-off (e.g. by ripple control receiver or clock, ...)
Contact closed and $u5r . \rightarrow on .$ = repressed vector shifts (e.g. when switching on ...),
contact closed and $u5r . \rightarrow y 1 y 2 .$ = no evaluation of the feedback contacts (e.g. for synchronisation, ...)
- 7) 1 phase Application connect L1-L2-L3, 2 phase Application L1 / L2+L3 (only Pr 5, 7, 10, 13, 20)
- 8) Additional switch-off of self generating plant.
Single-fault safety: shutdown of the self generation plant e.g. by ripple control input 0% with K2. Use coupling relays ford contact multiplication of if safe isolation is required.
This second shutdown path must be tested separately during commissioning. ($t5t2$)
- 9) Power supply / buffering. Switches have to withstand undervoltage for min.3 s (FRT)

1.5 1x PV, 1x section switch with nc/normally closed contacts
(medium voltage VDE-AR-N 4110:2018-11 / high voltage VDE-AR-N 4120:2018-11)

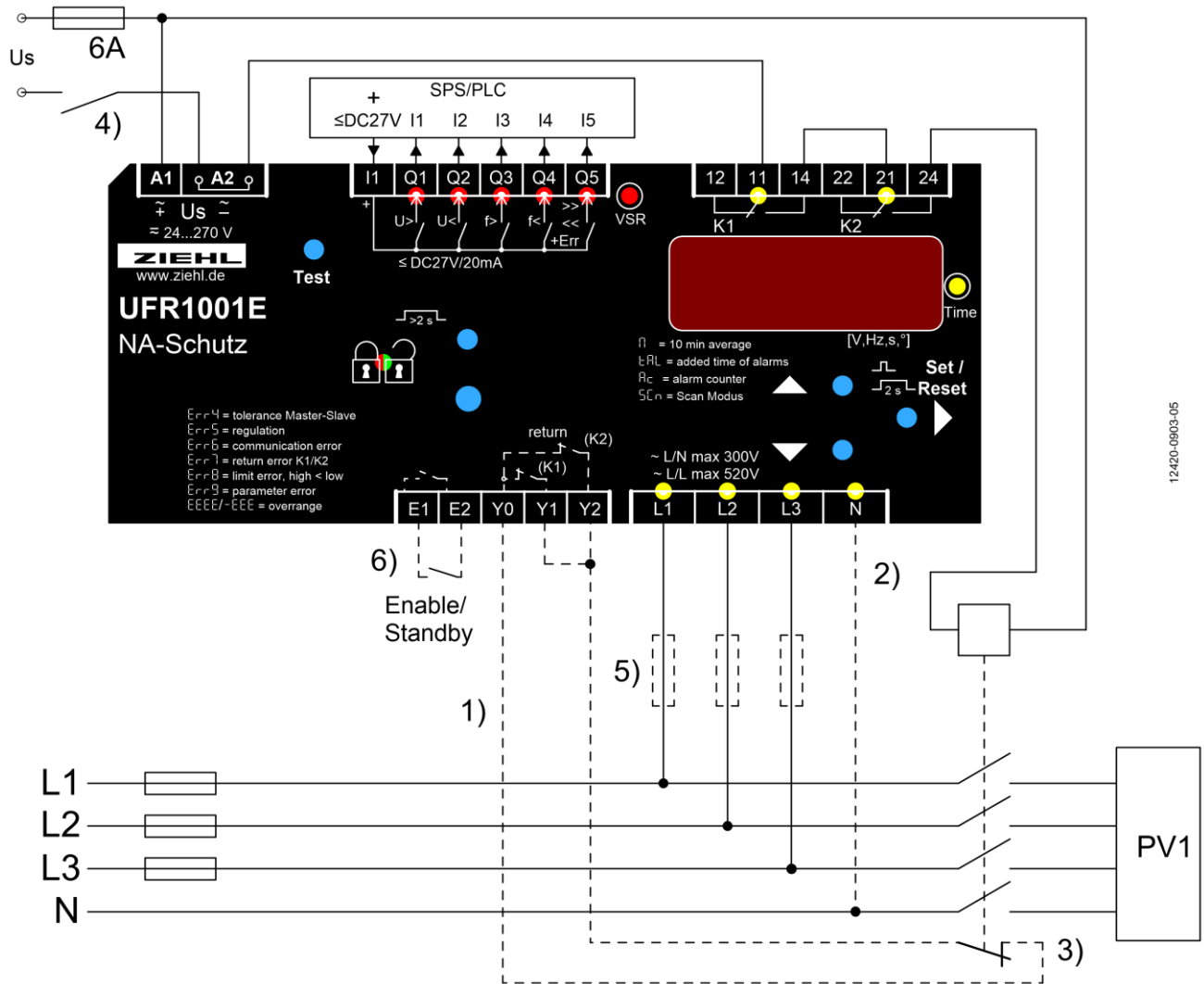

12420-0903-05

- 1) Feedback contacts Y1/Y2 not connected set rEL → t_rEL → **OFF**.
- 2) N connected → only for programs with N
- 3) NC- or NO-contacts can be connected, self-learning when switching on
- 4) Switch off the plant without recording an alarm, e.g. with output contact of a ripple control receiver
- 5) Fuses only when line protection necessary, e.g. 3x16A
- 6) Contact closed an $u5r$ → **5tby**. (default setting) = Standby, K1+2 switched-off (e.g. by ripple control receiver or clock, ...)
 Contact closed and $u5r$ → **on** = repressed vector shifts (e.g. when switching on ...),
 contact closed and $u5r$ → **yly2** = no evaluation of the feedback contacts (e.g. for synchronisation, ...)

1.6 Using integrated switches of PV and battery inverters according to DIN EN 62109 (VDE 0126-4)

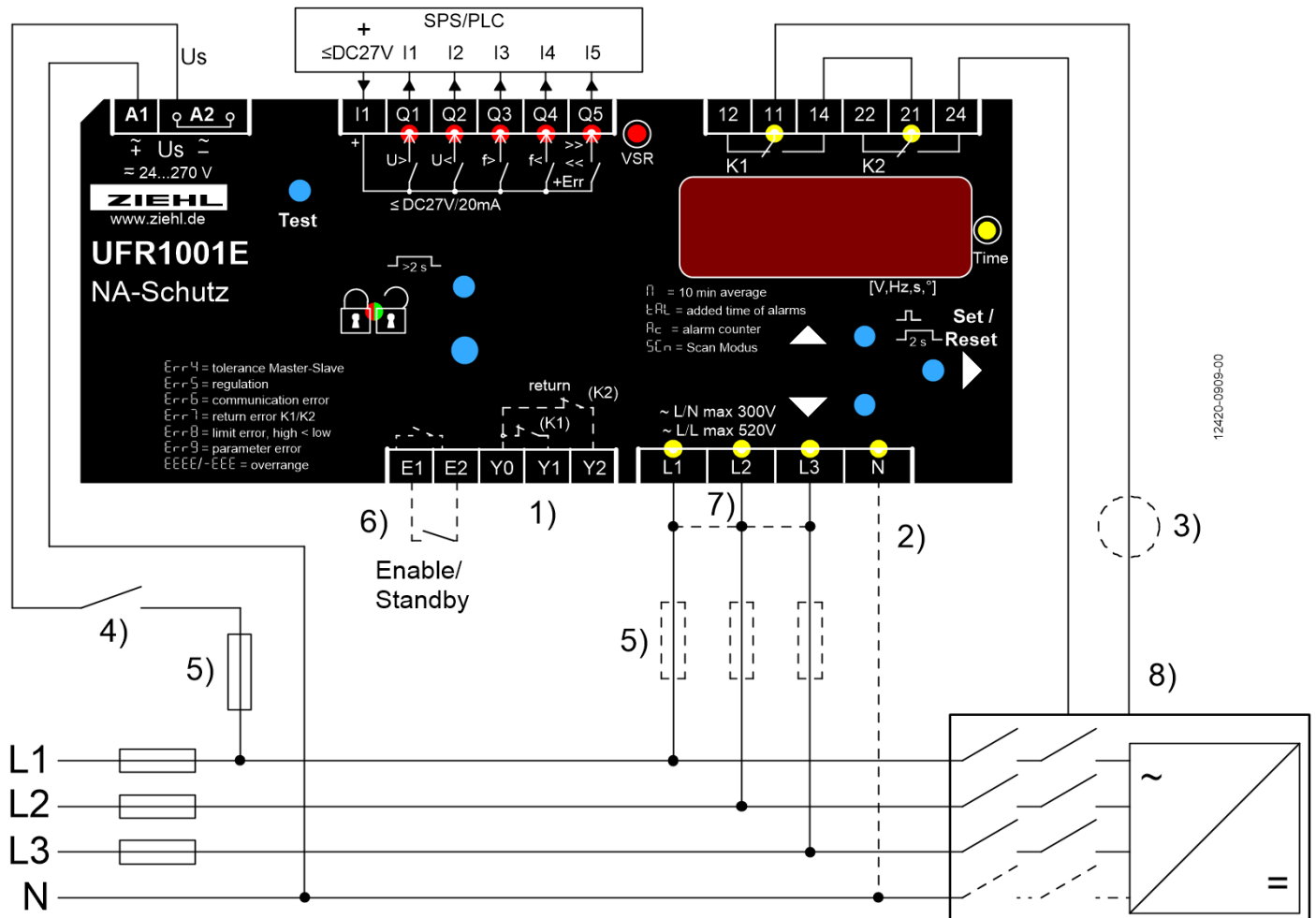

Wechselrichter mit integrierten AC Schaltern /
inverter with integrated AC switches

- 1) **Feedback contacts Y1/Y2 not connected** set rEL → $t rEL$ → oFF .
- 2) N connected → only for programs with N
- 3) If the inverter requires an external power source
- 4) Switch off the plant without recording an alarm, e.g. with output contact of a ripple control receiver
- 5) Fuses only when line protection necessary, e.g. 3x16A
- 6) Contact closed an $u5r$ → $5t b y$. (default setting) = Standby, K1+2 switched-off (e.g. by ripple control receiver or clock, ...)
Contact closed and $u5r$ → on = repressed vector shifts (e.g. when switching on ...),
contact closed and $u5r$ → $y 1 y 2$ = no evaluation of the feedback contacts (e.g. for synchronisation, ...)
- 7) 1 phase Application connect L1-L2-L3, 2 phase Application L1 / L2+L3 (only Pr 5, 7, 10, 13, 20)
- 8) non-islanding inverters acc. to DIN EN 62109 (VDE 1026-4) with integrated AC switches (internally monitored), approved according to VDE-AR-N 4105:2018-11

1.7 Generator operation, suppression of the feedback contacts (with external shut-down and mains synchronization)

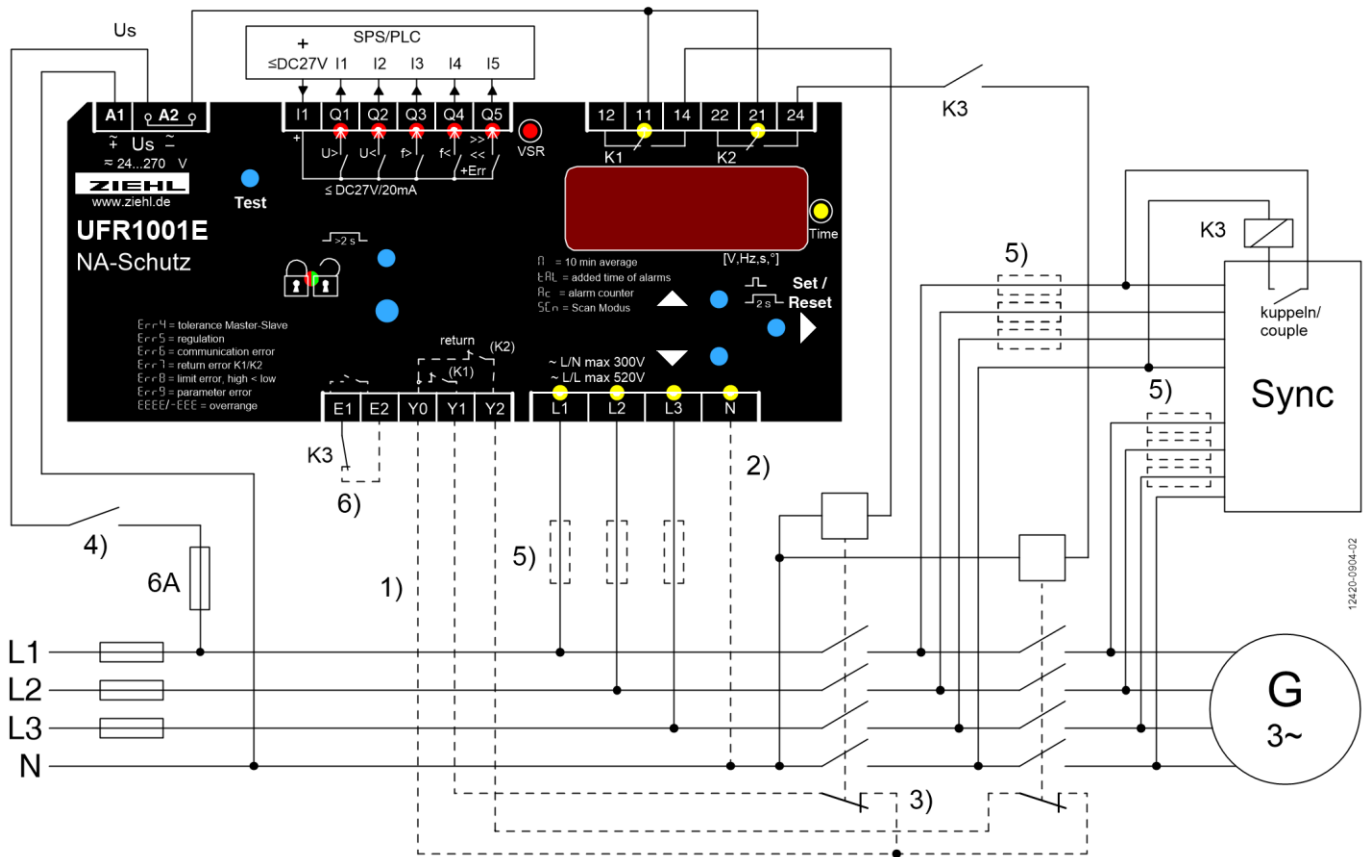

12420-0004-02

- 1) Feedback contacts not connected set $r_{EL} \rightarrow t_{rEL} \rightarrow \text{off}$.
- 2) N connected set $P_r 1$, $P_r 3$ or $P_r 5$
- 3) Nc- or no-contacts can be connected, automatic detection when switching on
- 4) Switch off the plant without recording an alarm, e.g. with output contact of a ripple control receiver
- 5) Fuses only when line protection necessary, e.g. 3x16A
- 6) Contact closed suppresses evaluation of feedback contacts and vector shift
($u_{5r} \rightarrow \text{on}$) suppresses feedback contacts ($u_{5r} \rightarrow y_{1y2}$) or switches device into standby ($u_{5r} \rightarrow s_{tbY}$ = default setting) e.g. through ripple control receiver or timer

9 Important information



A marked switch and a protective device must be provided in the supply line in the vicinity of the device (easily accessible) as a disconnecting element.

Flawless and safe operation of such a device requires proper transport and storage, professional installation and later commissioning along with operation as intended.

Only persons who are familiar with the installation, commissioning and operation of the device and who are correspondingly qualified for their job are permitted to work on the device. They must comply with the contents of the operating manual, the instructions attached to the device and the pertinent safety regulations for the erection and operation of electrical equipment.

The devices are built and certified in accordance with EN 60255 and leave the factory in a safe and technically flawless condition. To maintain this condition they must comply with the safety regulations marked in the operating manual with the headline "Caution". Failure to follow the safety regulations can lead to death, bodily injury or property damage to the device itself and to other devices and equipment.

If the information contained in the operating instructions/operating manual are not sufficient, please contact us directly or contact your responsible agency or representative.

Instead of the industrial norms and stipulations stated in the operating manual and applicable in Europe you must comply with the valid and applicable regulations in the country of utilisation if the device is used outside of the area of application.



WARNING

Hazards electrical voltage!

Can lead to an electric shock and burns.

Disconnect and de-energize before working on the system and the device.

Comply with the maximum permissible temperature when installing in a switch cabinet. Ensure sufficient clearance to other devices or heat sources. If cooling is inhibited, e.g., through close proximity to devices with increased surface temperature or interference with the cooling-air current, the permissible ambient temperature is decreased.



Caution!

Before you apply mains voltage to the device, make sure that the permissible control voltage **Us** on the side rating plate matches the mains voltage connected to the device!

10 Assembly

The device can be mounted:

- Distribution panel or control panel on 35 mm rail according to EN 60715

11 Detailed description

1.8 Description of the connections

Connection	Description
A1 and A2	Rated control supply voltage U_s , see Technical Data
11, 12, 14; 21, 22, 24	Relay K1 and K2
E1 – E2 Enable – Input	Volt-free contact
	$u5r$ → OFF, no function
	$u5r$ → on, E1-E2 closed: Vector shift active but not evaluated, monitoring of feedback contacts off for use with generator (mains synchronization)
	$u5r$ → 5tb4, E1-E2 closed: K1 and K2 off (standby), vector shift off
Y0, Y1, Y2 Inputs, feedback contacts	Volt-free n/o or n/c contact, self-learning when switching on
	Set value > turn-on time section switch under rEL → ErEL / can switch-off if not connected or if external devices/switches can activate the section switch (OFF)
I1	Supply voltage for digital outputs, max. 27 V DC
Q1...Q4	Digital output over-/under voltage/-frequency, Q3 + Q4 = ROCOF
Q5	Digital output error, in Programs with >> and << additionally the 2nd threshold value
L1, L2, L3, N	Phase L1, L2, L3 and neutral conductor







1.9 Functional characteristics

Functional characteristics	Explanation
VSR display value	The highest measured value is always displayed. The display value is reset to 0 by deleting the max. value and when resetting into the go (good) state.
Delay Enable On time	Runs down when starting the unit and after opening the enable input; during this time there is no evaluation of the vector shift
Reset time	When a reset time d_{oF} is running, it is always counted down in the display (shortest one first)
Reset	Use the Reset key or interrupt the control voltage for > 2 s (comply with reset delay)
Display mode S_{cn}	After the last measurement it switches into the scan mode; this is indicated by the display S_{cn} . All measurements will now be displayed cyclically for the time set in $d_i t$.
MIN / MAX values	All min and max values are saved zero-voltage maintained (non-volatile).
Tripping time (only with feedback contacts connected)	Connecting the feedback contacts enables measuring of the shut-down time. After a tripping test via the test menu (button test) and selection of the trip circuit (see test mode), the respective tripping time is displayed. (Pr2 and Y1+Y2 bridged, display for K1 only) The display duration is max. 3 minutes or until button test is pressed. The display resolution is 1ms. Total shut-down time = Tripping time + Response time d_{RL} . After a shut-down in the simulation mode the total shut-down time is displayed until the button is pressed again) The longer time of both channels is always displayed.
Alarm counter	The unit saves max 100 alarms (cause, measurement value, at operating time). The LEDs indicate the cause; the tripping value that led to the alarm each stands in the 7-segment display. Alternately the time difference, current operating time – tripping operating time is displayed. (how long ago the alarm triggered)
Cumulative alarm time t_{RL}	The cumulative alarm time TAL indicates how long the relay was switched off due to an alarm. It is recorded with a resolution of 1 minute and only when the control voltage is applied. Query: In the display mode \blacktriangleright button to R_c is displayed. 1x \blacktriangle button = Cumulative alarm time t_{RL} .
Standby mode $u_{5r} \rightarrow 5t_{bY}$	If E1-E2 are closed (e.g., by ripple control receiver, timer, dimmer), Relays K1 and K2 are switched off. The number and duration of the shut-downs is recorded. Query: In the display mode \blacktriangleright button to R_c is displayed. 2x \blacktriangle button = Standby counter $5t_{bY}$. 1x \blacktriangle button = Standby time $5t_{bY}$.
synchronization mode $u_{5r} \rightarrow 9192$	If E1-E2 are closed, the evaluation of the feedback contacts is suppressed. That means when using generators, a section switch can be used for mains synchronization.
Automatic restart attempts	If there is an error by the feedback contacts E_{rr1} , 2 restart attempts are automatically performed in an interval of 10s. False triggering by undervoltage trips (e.g. during a thunderstorm) do not lead to permanent shut-down.
Frequency undervoltage protection U_{onF}	If one of the measured voltages less than U_{onF} , the frequency evaluation is interrupted until all voltages have exceeded U_{onF} . (does not apply to device start / apply of the control voltage)

12 Commissioning

1.10 Program setup

The suitable program must be set on the UFR1001E in accordance with the application. If the UFR1001E is sealed/locked (red LED illuminated), the sealing has to be deactivated first.

Pr	Connection	Limit	Voltage	Country / Standard
* 2	3 AC with N	<u>Low voltage</u> 2x over voltage, 2x under voltage 2x over frequency, 2x under frequency 10min average value, 1x vector shift 1x ROCOF	230V	 VDE-AR-N 4105:2018
1	3 AC with N	<u>Low voltage</u> 1x over voltage, 1x under voltage 1x over frequency, 1x under frequency 10min average value, 1x vector shift 1x ROCOF	230V	 VDE-AR-N 4105:2011
7	2/1 AC with N			
11(3)	3 AC with N	<u>Medium voltage</u>	57,7V	 VDE-AR-N 4110:2018 VDE-AR-N 4120:2018 (BDEW June 2008 by 3.2.3.3-1)
12(4)	3 AC without N	2x over voltage, 2x under voltage	100V	
13(5)	3/2/1 AC with N	2x over frequency, 2x under frequency 10min average value, 1x vector shift 1x ROCOF	230V	
14(6)	3 AC without N		400V	
10	3/2/1 AC with N	2x over voltage, 2x under voltage 2x over frequency, 2x under frequency 10min average value, 1x vector shift 1x ROCOF	230V	 TOR Erzeuger Typ A,B,C,D
15	3 AC with N		230V	 NA/EEA-NE7 CH 2020
20	3/2/1 AC with N	2x over voltage, 2x under voltage	230V	 G98(G83/2) + G99(G59/3)
21	3 AC without N	2x over frequency, 2x under frequency	400V	
22	3 AC with N	10min average value, 1x vector shift	63,5V	
23	3 AC without N	1x ROCOF	110V	
16	3 AC with N	1x over voltage, 1x under voltage 1x over frequency, 1x under frequency 1x ROCOF, zero voltage	230V	 Synergrid C10/C11











* default setting

Adjustment process:

If present, remove seal (only authorised person)

- Apply control supply voltage at A1-A2
- Slightly lift the key cover and turn 180°
- Actuate the small blue button by firmly pressing the button cover (LED starts flashing) until the green LED  is illuminated.

Sealing is deactivated

- Press  button 1x → display 
- Press  button 5x → display 
- Set the program with the buttons  
- Press  button 1x → display 
- Press  button 1x → display 
- Press  button
→ Device resets and starts with the newly selected program

Hint: When changing programs, all parameters of the selected program are reset to “default settings“ (see table „Default settings“). **Only change the parameters after having selected the correct program.**

1.11 Control chart Pr 2...6 and Pr 10...23

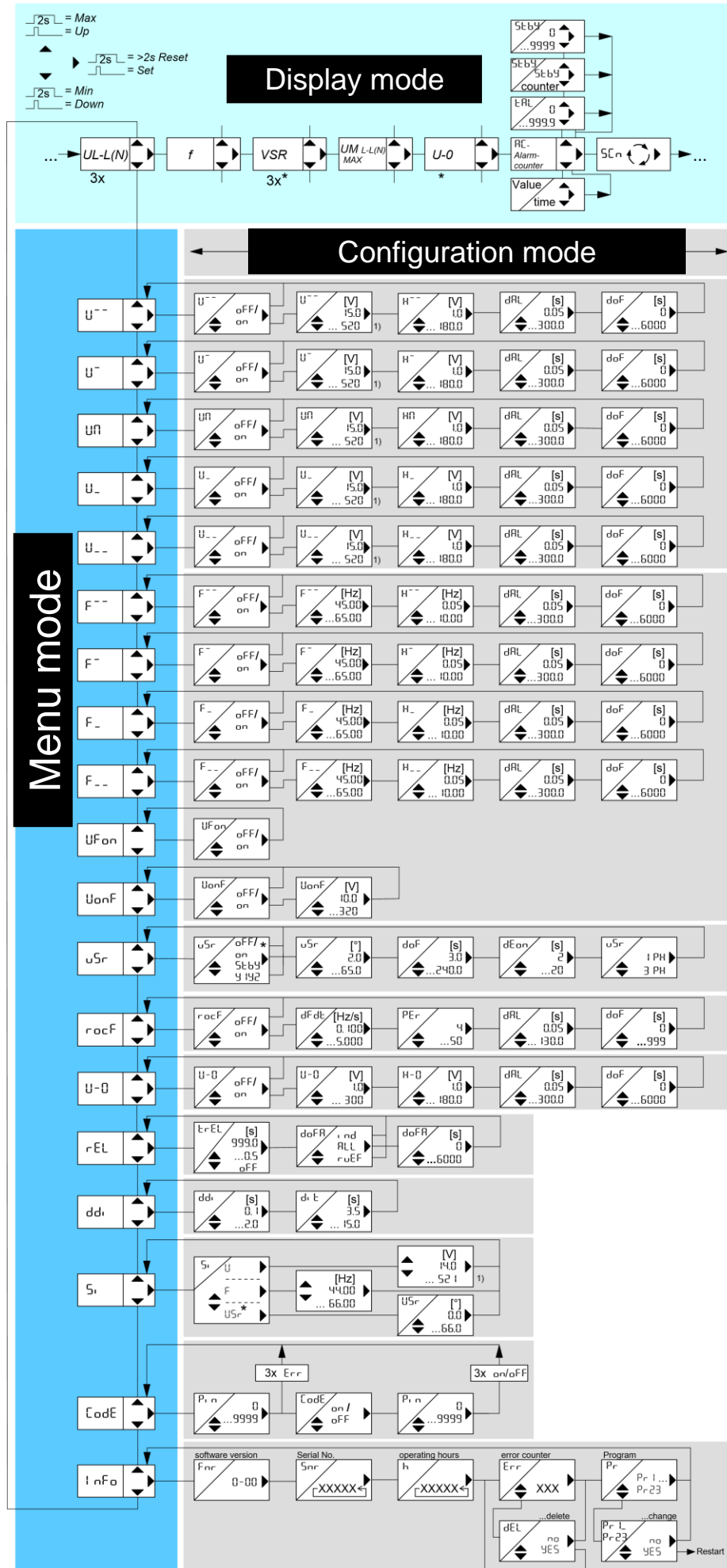

Pr	Connection	Country / Stand
2	3 AC + N	VDE-AR-N 4105:2018
11	3 AC + N	VDE-AR-N 4110:2018 4120:2018
12	3 AC	
13	3/2/1 AC + N	
14	3 AC	BDEW Juni 2008 nach 3.2.3.3-1
3	3 AC + N	
4	3 AC	
5	3/2/1 AC + N	
6	3 AC	TOR Erzeuger Typ A,B,C,D
10	3/2/1 AC + N	
15	3 AC +N	NA/EEA-NE7 CH 2020
20	3/2/1 AC + N	G98(G83/2) + G99(G59/3)
21	3 AC	
22	3 AC + N	
23	3 AC	
16	3 AC + N	Synergrid C10/C11

1) 3AC+N = 300V
 *) only displayed if activated

[] = Unit
 Up/Down simultaneously sets the value to the lowest value.

Code-Reset = 2 s Set when mains are switched on. (Pin = 504)

Error messages:

- Err4 = Tolerance Master Slave
- Err5 = Internal control
- Err6 = Communication
- Err7 = Contactor feedback contacts K1/K2
- Err8 = Limit error
- Err9 = Parameter error

1.12 Control chart Pr 1 and Pr 7

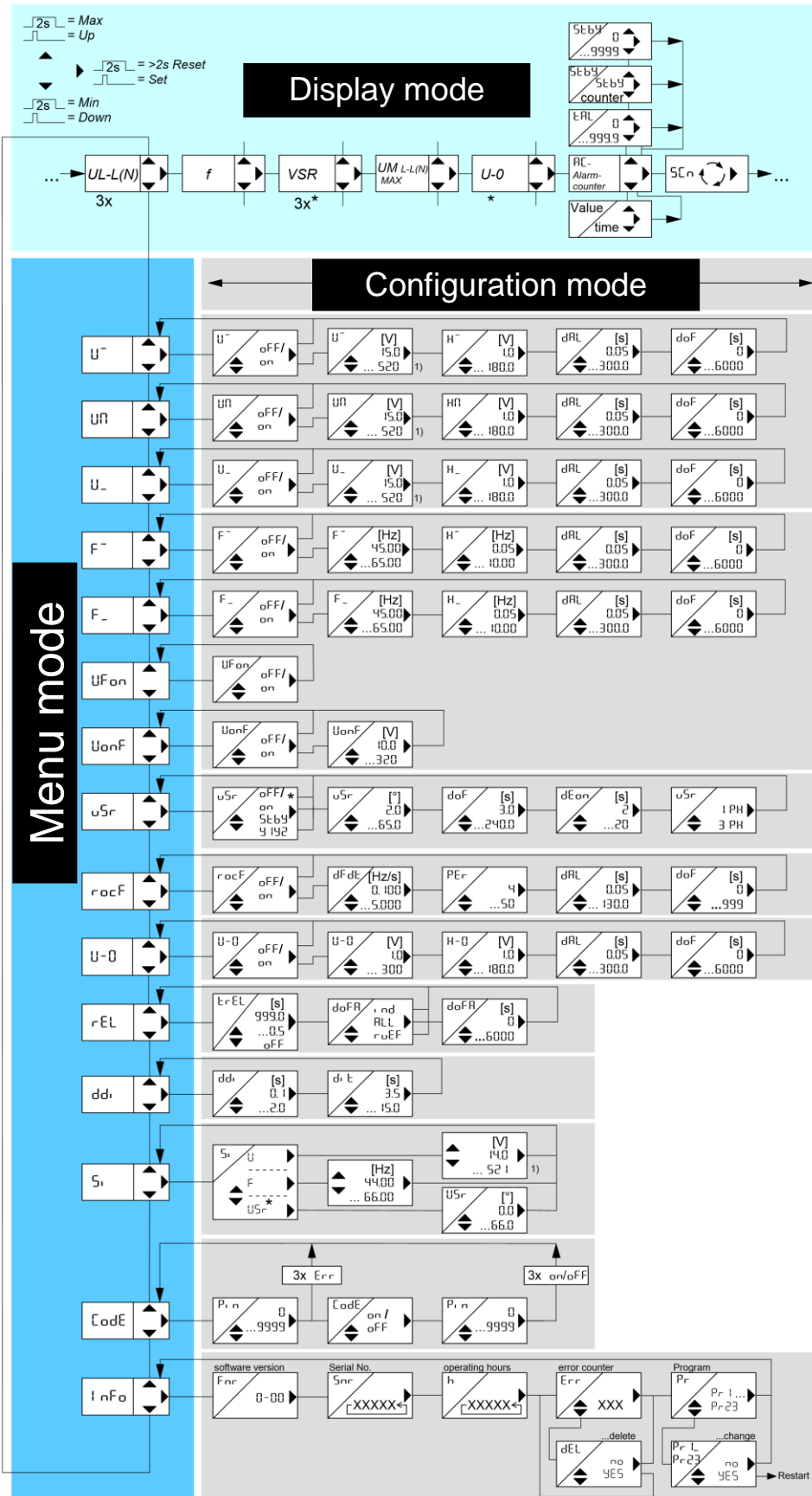

Pr	Connection	Country / Stand.
1	3 AC + N	 VDE-AR-N 4105:2011
7	2/1 AC + N	

1) 3AC+N = 300V
 *) only displayed if activated

[] = Unit
 Up/Down simultaneously sets the value to the lowest value.
 Code-Reset = 2 s Set when mains are switched on. (Pin = 504)

Error messages:

- Err4 = Tolerance Master Slave
- Err5 = Internal control
- Err6 = Communication
- Err7 = Contactor feedback contacts K1/K2
- Err8 = Limit error
- Err9 = Parameter error

1.13 Description of the parameters

Parameters	Display	Explanation	Adjustment range
Limit value	U ⁻ U ⁻ U ₋ U ₋₋ U _n	Voltage limit value	15.0 ... 300 15.0 ... 520
Limit value	U _{onF}	Limit value for voltage (L1/2/3 < U _{onF} = frequency protection off)	10.0 ... 320
Limit value	F ⁻ F ⁻ F ₋ F ₋₋	Frequency limit value	45.00 ... 65.00
Limit value	dFdt	ROCOF, df/dt limit value	0.10 ... 5.00
Limit value	U-0	zero voltage limit value	1.0 ... 300
Hysteresis	H	253V (Limit) – 3V (Hysteresis) = 250V (Reset value)	1.0 ... 180.0 0.05 ... 10.00
Response time (delay Alarm)	dRL	An alarm is suppressed for the set time (seconds)	0.05 ... 300.0 0.05 ... 180.0
Turn-on time (delay Off)	d _{oF} d _{oFR}	Reset is delayed for the set time, also during voltage recovery, this time (seconds) is always counted down in the display d _{oFR} : d _{oF} for U+f together	0 ... 6000
Enable time (delay On)	dE _{on}	There is no evaluation of the vector shift during this time; starts with the application of the control voltage and when opening the Enable input	2 ... 20
VSR	uS _r	1 Ph : a vector surge on one phase leads to an alarm 3 Ph : a vector surge on all phases simultaneously leads to an alarm	1 Ph ... 3 Ph
Periods	PE _r	Measuring time ROCOF, (4=sensitive, 50=insensitive) Response time= PE _r * Period duration + dRL	4 ... 50
delay Display	dd _i	Interval during which the display is updated in the display mode	0.1 ... 2.0

1.14 Display mode (last decimal point off)

In the display mode, the UFR1001E is in its normal state; here, depending on the program, the actual voltage, the highest actual 10 minute mean value, the frequency or the vector surge is displayed. In addition, the alarm signals (e.g. **RL** , **RL n**) and error codes (e.g. **Err9**) are displayed.

Function button Set / Reset	<u>Press briefly:</u> Switches the measurement, alarm counter
	<u>Press for > 2 s:</u> Resets after error (not possible if doF Reset delay is counting down)
	<u>Press for > 4 s:</u> Displays the program, e.g. Pr 1
	<u>Press for > 10 s:</u> Displays the software version, e.g. 0-05
Function key Up / Down	<u>Press briefly:</u> Change into the menu mode, Display alarm counter: Down = Query the memory Up = Query the cumulative alarm time
	<u>Press for ≥ 2 s:</u> Displays MAX and MIN measurements, additionally pressing the Set key for ≥ 2 s deletes the saved values

1.15 Menu mode (last decimal point on)

The menu mode is used to select the menu items. If no key is pressed for 30 s, one automatically returns to the display mode.

Function button Set / Reset	<u>Press briefly:</u> Change into the configuration mode
	<u>Press for ≥ 2 s:</u> Returns to the display mode (the most recently set values are then applied)
Function key Up / Down	<u>Press briefly:</u> Select menu item; changes into the display mode

1.16 Configuration mode (last decimal point flashes)

In the configuration mode you can set the value of a parameter. The display alternates between the parameter relation and the currently set value until one of the Up/Down buttons is pressed, which changes the value of the parameter. If no key is pressed for 2 s the display starts alternating again.

If no key is pressed for 30 s (simulation mode 15 min) one automatically returns to the display mode (the most recently set value is applied during this)

Function button Set / Reset	<u>Press briefly:</u> The settings are taken over; continue to next parameter. Changes into menu mode after the last parameter
	<u>Press for ≥ 2 s:</u> Returns to the display mode (the most recently set values are then applied)
Function key Up / Down	<u>Press briefly/long:</u> Value change of the parameter (slow/fast)

Hint: Simultaneously pressing the Up and Down keys resets the adjustable value to zero. If the Up or Down button is kept pressed while setting the value the change in the display is accelerated.

1.17 Switching conditions

After switching-on the auxiliary voltage the relays only switch-on when the switch-back limit (switching conditions / limit \pm hysteresis) of all alarms have been reached.

With the parameter **UFon**, the behaviour of the switching conditions after a off-limit violation can be determined:

UFon → **on** the switch-back limits of the alarms undervoltage, underfrequency and overfrequency must be fulfilled for switch-on

UFon → **off** only the switch-back limit of triggered alarm must be fulfilled for switch-on

1.18 Disengaging ratio

The disengaging ratio is the ratio between the disengaging value and the start value. The start value is the value at which the limit is recognized and the on-delay time **dRL** starts. The disengaging value is the value at which **dRL** stops running if it reached before **dRL** expires.

Activate the **rUEF** function for simple measurement of the disengaging ratio.

Function while **rUEF** is active:

When limit value is reached (= **dRL** starts) → relay OFF.

When the disengaging value is reached (= **dRL** cancelled) → relays ON.

Disengaging ratios can only be checked for U>>, U>, U<, U<< (not for f, zero voltage and 10min average value). For testing e.g. U >>, U > must be switched "off."

rUEF can be selected under the menu item **rEL** → **doFR**. The "time" LED flashes when **rUEF** is active. To switch off the function select **rEL** → **doFR** → **ALL** and confirm with "set". The delay-off time **doF** for all alarms can be set here to the values required by the system operator. The function switches off automatically after 600 s.

1.19 Monitoring of zero voltage

The zero voltage U_0 (ANSI 59v0) is the modulus of the zero-component system, $U_0 = |U_0|$. The zero-component system is an operand from the phase-to-neutral voltages (U_{L1}, U_{L2}, U_{L3}) and the phase angles ($\varphi_{L12}, \varphi_{L23}, \varphi_{L31}$) and is defined by the following equation: $U_0 = \frac{1}{3} * (U_{L1} + U_{L2} + U_{L3})$.

Activate the **U-0** function for simple measurement of the zero voltage. All other parameters such as limit value, hysteresis and delay times can be set under this menu item.

Function while **U-0** is active:

When limit value is reached (= **dRL** starts) → relay OFF. This state is indicated by flashing-on the LED and switching-on of the digital outputs Q1 and Q2, respectively.

When the fallback value is reached (= **doF** starts) → relay ON. LED/ digital outputs Q1+Q2 off.

1.20 Test mode (timekeeping only activated and connected feedback contacts)

After pressing the Test button, the test-menu is displayed and both trip circuits can be tested. If additionally, feedback contacts of the switch are connected to the UFR100E and activated (value t_{rEL} > turn-on time of switch, e.g. 5.0s), the triggering time is measured automatically. The measurement voltage has to be connected and no alarm is allowed to be present (K1 and K2 picked up)! During the test an active $Err1$ is repressed. This allows troubleshooting for minimum 3 minutes.

Start test:

Select circuit K1 ($t5t1$) or K2 ($t5t2$) by pressing the buttons Up / Down. The test starts, after pressing the button Set and the selected relay is switched off. If the feedback contact is connected (Y1 or Y2), the tripping time of internal relay + switch is displayed for 3 minutes or until the button test is pressed.

Without connected / activated feedback contacts, $noY1$ or $noY2$ is displayed.

To exit the test-menu, wait for 3 minutes without a button or select End by pressing the buttons Up / Down and confirm by pressing the button Set.

1.21 Alarm counter

The alarm counter Rc is increased by 1 with every shut-down. Up to 100 shut-downs are counted. That allows quick detection of how often the UFR1001E has shut down since the last delete of the alarm counter (see cumulative alarm time).

Query the alarm counter:

- | |
|--|
| <ul style="list-style-type: none">• Change into the display mode |
| <ul style="list-style-type: none">• Press the \blacktriangleright button several times until \rightarrow display $Rcxx$ |

1.22 Cumulative alarm time (display in hours)

The cumulative alarm time tRL indicates how long the relay was switched off due to an alarm. It is recorded with a resolution of 1 minute and only when the control voltage is applied.

Query the cumulative alarm time:

- | |
|--|
| <ul style="list-style-type: none">• Change into the display mode |
| <ul style="list-style-type: none">• Press the \blacktriangleright button several times until \rightarrow display $Rcxx$ |
| <ul style="list-style-type: none">• Press the \blacktriangle button 1x \rightarrow display $tRL / x.xx$ |



Delete the alarm counter and cumulative alarm time (only together):

- | |
|--|
| <ul style="list-style-type: none">• Display alarm counter $Rcxx$ |
| <ul style="list-style-type: none">• Press the \blacktriangle button 1x \rightarrow display $tRL / x.xx$ |
| <ul style="list-style-type: none">• Keep the \blacktriangleright button pressed for 2s until \rightarrow display $tRL / 0.00$ |

1.23 Alarm memory

Independent of the alarm counter, the UFR1001E stores the most recent 100 shut-down causes (cause, measurement value, at operating time). Simulated alarms are also registered. The LEDs indicate the cause; the tripping value that led to the alarm each stands in the 7-segment display. Alternative to that the time is shown in hours which have passed since the last tripping (with applied control voltage). These values remain saved even after the power has been turned off.

Query alarm memory:

• Change into the display mode
• Press the  button several times → display RcXX
• Press the  button 1x → display xxx / xxx (tripping value or error no. / time that has passed in hours)
• Press the  button 1x, go to next alarm

The alarm memory is only deleted during a program change.

1.24 Standby counter and standby time



The standby counter **StbY**, is increased by 1 with every standby shut-down. Up to 9999 shut-downs are counted. That lets the UFR1001E quickly detect how often, e.g., shut-down was performed through a ripple control receiver.

Query the standby counter:



• Change into the display mode
• Press the  button several times until → display RcXX
• Press the  button 2x → display StbY / xxxx

The standby time **StbY** indicates how long the relay was switched off by the standby mode. It is recorded with a resolution of 1 minute and only when the control voltage is applied and if no alarm is present.

Query the standby time:

• Change into the display mode
• Press the  button several times until → display RcXX
• Press the  button 3x → display StbY / xxx (Time LED is illuminated)

Delete the standby counter and standby time (only together):









• Display alarm counter RcXX
• Press the  button 2x → display StbY / xxxx
• Keep the  button pressed for 2s until → display StbY / 0

1.25 Code lock

You can protect the set parameters by enabling the code lock here.

The device acknowledges an incorrect entry with **Err** (flashes three times).

Adjustment process:

• Select the menu item with the   buttons until → display Code
• Press the  button 1x → display Pin / 0
• Set the saved pin code with the   buttons (default setting is 504)
• Press the  button 1x → display Code / off
• Use the   buttons to set the desired code lock: <ul style="list-style-type: none">○ off off, all parameters can be changed○ on on, no parameters can be changed
• Press the  button 1x → display Pin / 504

<ul style="list-style-type: none"> Use the ▲▼ buttons to set the new, desired pin code (caution: write down the pin code)
<ul style="list-style-type: none"> Press the ▶ button 1x
<ul style="list-style-type: none"> ⇒ Code lock on, display on flashes three times ⇒ Code lock off, display oFF flashes three times
<ul style="list-style-type: none"> ⇒ Return to menu mode, menu item code lock

If there are any problems with the code lock (pin forgotten), the lock can be switched off and the pin can be reset to 504 by keeping the Set key pressed while switching on the mains until ▶ **Code** / **oFF** appears in the display.

1.26 Sealing

All the settings and the simulation mode can be locked.

If the  LED is illuminated, the UFR1001E is locked.

If an attempt is made to change a setting in the locked state, for 3s the display shows **Loc**.

Adjustment procedure Sealing/Lock ON (OFF):

<ul style="list-style-type: none"> If present, remove seal (only authorised person)
<ul style="list-style-type: none"> Apply control supply voltage at A1-A2
<ul style="list-style-type: none"> Slightly lift the key cover and turn 180°
<ul style="list-style-type: none"> Actuate the small blue button by <u>pressing the button cover very firmly</u> (LED starts flashing) until the green LED  is illuminated.

1.27 Simulation

Here, the voltage, frequency or a vector surge can be simulated and the setting can be tested. All 3 phases plus the 10 minute mean value are always simulated. All functions of the device operate as if this value is actually being measured. Alarm and error messages are only indicated with the LEDs and not in the display. The set values are simulated until the menu item **S_i** is exited with the ▲ or ▼ button. If the UFR1001E is sealed/locked, simulation is not possible.

If the section switch feedback contacts are connected to the UFR1001E and enabled, (set value > section-switch turn-on time under **trEL**), after a shut-down, the tripping time (dAL + time of slowest section switch) is displayed.

Adjustment process:

<ul style="list-style-type: none"> Select the menu item with the ▲▼ buttons until → display S_i
<ul style="list-style-type: none"> Press the ▶ button 1x → display S_i / U
<ul style="list-style-type: none"> Use the ▲▼ buttons to set the measurement factor for simulation: <ul style="list-style-type: none"> ○ U Voltage + 10min mean value (frequency = last simulated value) ○ F Frequency (voltage = last simulated value) ○ uSr Vector shift
<ul style="list-style-type: none"> Press the ▶ button 1x → display 230 (selected measurement factor is simulated)
<ul style="list-style-type: none"> Use the ▲▼ buttons to set the desired value

After exiting the Simulation menu item with the ▲▼ buttons, the unit switches over to monitoring the limits. The unit automatically returns to the display mode if no button is pressed for 15 minutes.

Hint: A limit value should be tested that is higher than the set 10min mean value. If the 10min mean value has to be temporarily switched off, set (**UN** → **oFF**) since otherwise it will trip first. The same applies, for example, for **U⁻**, during a simulation of **U⁻** in Pr3 and Pr4. (Medium voltage)

1.28 Possible indications in display

Display mode

AL , AN , ALUD	Alarm , Alarm 10min mean value, Alarm zero voltage U ₀
Err4 ... Err9	Error messages (see Error messages and measures)
Ac , tAL	Alarm counter, cumulative alarm time
Scn , n	Scan mode, 10min mean value

Menu mode / configuration mode

U ⁻ , U ⁻ , U ₋ , U ₋	Voltage limit value
UN	Limit value 10min mean value
H ⁻ , H ⁻ , H ₋ , H ₋ , HN	Hysteresis (if a limit value is changed, the reset value also shifts; that means it might be necessary to adapt it)
F ⁻ , F ⁻ , F ₋ , F ₋ , dFdE	Frequency limit value, ROCOF (df/dt) limit value
dAL	Response time
doF , doFA	Reset time; is always counted down in the display
ind , ALL	Turn-on time adjust individual / all together (e.g. for Testing)
uSr	Vector surge
StbY	Standby mode, standby-time, standby-counter
Y1Y2	Evaluation of the feedback contacts is suppressed when E1-E2 are closed
dEon	Delay Enable On, suppression time when switching on and after opening the enable input
1 Ph , 3 Ph	Single phase, three-phase vector shift evaluation
roCF , PEr	ROCOF (df/dt), Periods
rEL	Relay
tREL	Section switch turn-on time, OFF no feedback contacts
ddi	Delay display, to calm down the display
diE	Display duration scan mode (each measurement is displayed for this duration)
Si , F , U	Simulation, Frequency, voltage
CoDE , PLo , uSr	Code lock / sealing, vector shift
Pin , InFo	Pin code (default 504), Device information, program change
Fnr , Snr	Firmware version, serial number
h	Operating hours
Err , dEL	Error counter, delete error counter
YES , no	Yes, no query for acknowledgement
Pr , on , oFF	Program, On, Off
UonF	Frequency protection off if voltage < U _{onF}
tSt1 , tSt2 , noY1 , noY2 , End	Test mode: test relay K1, test relay K2, no response Y1, Y2 or monitoring feedback contacts not activated
rUEF	Function for testing disengaging ratio
UFon	Switch-on behaviour after off-limit condition

13 Technical Data

Control voltage Us:

Rated connection	AC/DC 24-270 V, 0/40...70 Hz, < 5 VA DC: 20.4...297 V, AC: 20.4...297 V
Bridging time at dropping Us	230 V → 0V: 400 ms

Output relay:

Switching voltage	2 x change-over contact Max. AC 440 V
Conventional thermal current I _{th}	6 A
Inrush current (at 10 % ED)	25 A max. 4 s / 50 A max. 1 s
Nominal operating current I _e (AC 15)	I _e = 6 A U _e = 250 V
Rated operational current	DC-13 I _e = 2 A U _e = 24 V
Rated operational voltage	DC-13 I _e = 0,4 A U _e = 120 V DC-13 I _e = 0,2 A U _e = 240 V
Recommended series fuse	gG/gL/B 6 A
Contact service life, mech.	30 x 10 ⁶ switching cycles
Contact service life, electr.	1 x 10 ⁶ operating cycles at AC 250 V / 6 A 2 x 10 ⁵ operating cycles at AC 250 V / 10 A cos φ 0.6
Clearance and creepage distance K1-K2	≥ 3mm

Voltage measurement:

Measurement voltage phase – phase	AC 15...530 V (< 5 V: 0 is displayed)
Adjustment range phase – phase	AC 15...520 V
Measurement voltage phase – N	AC 10...310 V (< 5 V: 0 is displayed)
Adjustment range phase – N	AC 15...300 V
Measurement principle	Real root mean square measurement both half waves
Hysteresis	Adjustable 1.0...180.0 V
Measurement error (with N)	± 0.6 % of the measurement value
Measurement error (without N)	± 0.8 % of the measurement value
Display accuracy	>100V: -1 digit (res. 1 V), <100V: -1 digit (res. 0.1V)
Measurement function	3-phase with/without N
Response time	Adjustable 0.05 (±15ms)... 300.0 s
Reset time	Adjustable 0(>200ms) ... 6000 s
Input resistance Phase-N	227 kΩ
disengaging ratio	< 2 % (at values > 20 V)

Frequency measurement:

Frequency range	40...70 Hz
Adjustment range	45.00...65.00 Hz
Hysteresis	0.05...10.00 Hz
Measurement accuracy	± 0.04Hz ± 1 digit
Response time	Adjustable 0.05 (±15ms)...300.0 s
Reset time	Adjustable 0 (>200ms) ... 6000 s
Frequency undervoltage protection	off / 10,0...320 V

Zero voltage:

Measurement voltage phase – N	AC 0...310 V
Adjustment range phase – N	AC 1...300 V
Measurement principle	U ₀ is calculated by U _{Lx-N} and φ _{Lx}
Hysteresis	Adjustable 1.0...180.0 V
Measurement error (with N)	± 1.8 % of the measurement value
Display accuracy	>100V: -3 digit (res. 1 V), <100V: -3 digit (res. 0.1V)
Measurement function	3-phase with/without N
Response time	Adjustable 0.05 (±15ms)... 300.0 s
Reset time	Adjustable 0(>200ms) ... 6000 s

Digital outputs (galvanic isolated)

Switching voltage I1	DC 4.5...27 V
Current Q1...Q5	Max 20 mA / output
<u>Vector surge</u>	
Measurement range	0...90.0°
Adjustment range	2.0...65.0°
Response time	< 50 ms
Reset time	Adjustable 3...240 s
Delay at Us on	Adjustable 2...20 s
<u>ROCOF (df/dt)</u>	
Frequency range	40...70 Hz
Adjustment range	0,100...5,000 Hz/s, 4...50 Periods
Hysteresis	fixed 0,05Hz
Measurement error	± 0,04Hz ± 1Digit
Response time	adjustable 0,05 (±15ms) ... 130,0 s
Reset time	adjustable 0 (>200ms) ... 999 s
Measurement time	Number of adjusted Periods * Periods duration + Response time
<u>Contactors feedback inputs</u>	
Voltage / Current Y0 – Y1/2	DC 15...35 V / ca. 4mA
Voltage / Current E1 – E2	DC 15...35 V / ca. 6mA
Contactors response time (section switch)	Adjustable 0.5...99.0 s
<u>Test conditions</u>	
	IEC/EN 60255
Rated impulse voltage	4000 V
Overvoltage category	III
Pollution degree	2
Rated insulation voltage Ui	300 V
Operating time	100 %
Operating temperature	-20 °C... +55 °C
Storage temperature	-25 °C ... +70 °C
Climatic conditions (IEC/EN 60721-3-3)	3K5 (except condensation and formation of ice)
Tests IEC/EN 60255-1	
Storage tests	
Dry heat	IEC 60068-2-2 + 70 °C 16 h
Cold	IEC 60068-2-1 - 25 °C 16 h
Operational tests	
Dry heat	IEC 60068-2-2 + 55 °C 16 h
Cold	IEC 60068-2-1 - 20 °C 16 h
Cyclic temperature	IEC 60068-2-14 - 25 °C / + 55 °C 5 cycle 3 + 3 h
Damp heat steady state	IEC 60068-2-78 + 40 °C 95 % RH 21 days
Cyclic temperature with humidity	IEC 60068-2-30 + 25 °C 97% RH / + 55 °C 93 % RH 6 cycle 12 + 12 h
IEC 60255-21-1	vibration class 1
IEC 60255-21-2	shock class 1
IEC 60255-21-3	seismic test class 1
EMC - immunity	EN 61000-6-2
EMC - emission	EN 61000-6-3
<u>Housing:</u>	
Construction form	V6
Front-to-back size	55 mm
Dimensions (W x H x D)	90 x 105 x 69 mm
Wiring connection single strand	each 1 x 4mm ²
Finely stranded with wire end ferrule	each 1 x 2.5mm ²
Protection class, housing	IP 30
Protection class, terminals	IP 20
	Mounting snap-on fastening on 35 mm mounting rail acc EN 60 715 or with M4 screwed attachment (additional bar not included in the scope of delivery)

Weight:

approx. 250 g

We reserve the right to make technical changes

14 Troubleshooting and measures

Error	Cause	Remedy
EEEE or -EEE appears in the display	Measurement is above/below range	Measured voltage, frequency or the vector surge is too large or too small; comply with measurement range
Err4 appears in the display	Tolerance error, internal measurement value deviation of both channels	Perform a reset → interrupt control voltage for >5s *
Err5 appears in the display	Error internal interface	In the case of Err5, check whether long cables are connected to terminals E or Y and/or whether they lead through an environment with interference.
Err6 appears in the display	Communication error, internal interface	
Err7 appears in the display even after 2 automatic repeated trials of switching on + LED K1 and/or K2 is flashing	Error feedback contacts, switches not connected correctly or broken or switches are controlled from other device	<u>Feedback contacts not connected</u> - set rEL . → tREL . → oFF <u>Feedback contacts connected</u> - check the correct connection - Adjust the turn-on time under rEL . → tREL . greater than the switch-on time of the switcher - Perform a reset → press Set/Reset for >2 s
Err8 appears in the display	Hysteresis error	Upper threshold value must be higher than the lower threshold value, check the threshold values
Err9 appears in the display	Parameter error	Reset to factory settings, see "Program setup" *
A time expires in the display	Always when an OFF-delay time doF is running, it is counted down in the display (shortest one first)	Wait until the time has expired (depending on the setting, several times may elapse one after the other)
Device cannot be configured / only the limits can be configured	Code lock / Sealing activated	If there are any problems with the code lock (pin forgotten), the lock can be switched off and the pin can be reset to 504 by keeping the Set key pressed while switching on the mains until CoDE / oFF appears in the display.
Implausible voltage values	Pr selected with N, but N not connected	Select Pr without N or connect N
Loc appears in the display	Seal is active	See Sealing
CoDE appears in the display	Code lock is active	See „Code lock“
StBY appears in the display	Standby mode, E1-E2 closed	Check parameter u5r .
RL and LED Q3 (f>) is on, reading in good range	hysteresis for F⁻ incorrectly	Check hysteresis for reset point >50 Hz
noY1 or noY2 appears in the display	Feedback contact not connected or switch does not switch	Check the connection and function of the switch. Its normal in Pr2 at Test 2 noY2 .

* If the error cannot be patched by a reset, send back to factory for repair.

15 Maintenance and repair

The UFR1001E is maintenance-free. Periodically test for proper functioning.

16 Construction form V6

Dimensions in mm

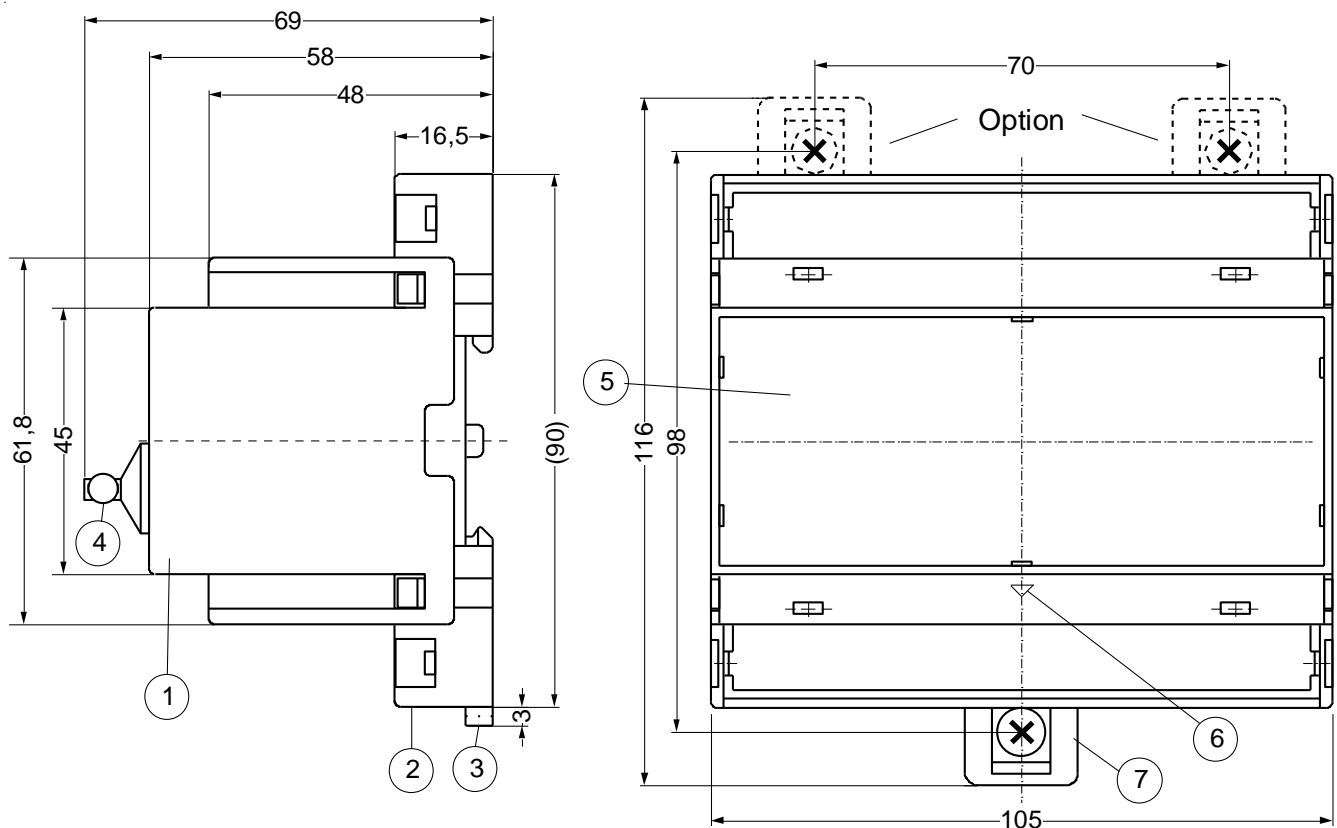

- 1 Oberteil / cover
- 2 Unterteil / base
- 3 Riegel / bar for snap mounting
- 4 Sealing max. \varnothing 1.8 mm
- 5 Frontplatteneinsatz / front panel
- 6 Kennzeichen für unten / position downward
- 7 Bar for wall attachment with screws. Riegelbohrung \varnothing 4,2 mm / Bolt hole for fixing to wall with screws, \varnothing 4.2 mm.

17 Disposal

Disposal should be carried out properly and in an environmentally friendly manner in accordance with legal provisions.

18 Adjustment values table VDE-AR-N 4105:2011, Low Voltage Pr 1+7

Protective function	AR 4105	ZIEHL	in * Un	in % Un	Adjustment value	Tripping time dAL	OFF-delay time doF
Voltage decrease protection	U<	U ₋	0.8 * Un	80 % Un	184 V	100 ms	60 s
Voltage increase protection (10-minutes mean value)	U>	U _∏	1.1 * Un	110% Un	253V	100 ms	60 s
Voltage increase protection	U>>	U ⁻	1.15 * Un	115% Un	264V	100 ms	60 s
Frequency decrease protection	f<	F ₋			47.5Hz	100 ms	60 s
Frequency increase protection	f>	F ⁻			51.5Hz	100 ms	60 s
Switching conditions		UF _{on}			off		

19 Adjustment values table BDEW June 2008, acc 3.2.3.3-1, Medium Voltage Pr 3-6

Function			Adjustment range of the protective relay	Default settings	
	BDEW	ZIEHL			
Voltage increase protection	U>>	U ⁻	1.00 – 1.30 U _n	1.15 U _n	100 ms
Voltage increase protection	U>	U ⁻	1.00 – 1.30 U _n	1.08 U _n	60 s
Voltage decrease protection	U<	U ₋	0.10 – 1.00 U _n	0.80 U _n	2.7 s
Voltage decrease protection *	U<<	U ₋	0.10 – 1.00 U _n	0.45 U _n	300 ms
Frequency increase protection	f>	F ⁻	50.0 – 65.0 Hz	51.5Hz	100 ms
Frequency decrease protection	f<	F ₋	45.0 – 50.0 Hz	47.5Hz	100 ms
Switching conditions		UF _{on}		off	

* Not enabled in as delivered condition

20 Adjustment values table VDE-AR-N 4105:2018-11, Low Voltage 6. table 2, Pr 2

Adjustment values for converters

Protective function	AR 4105	ZIEHL	in * Un	in % Un	Adjustment value	Tripping time dAL	OFF-delay time doF
Voltage increase protection	U>>	U ⁻ -	1,25 * Un	125 % Un	287 V	100 ms	60 s
Voltage increase protection (10-minutes mean value)	U>	U ⁻ ∏ ⁻	1,1 * Un	110 % Un	253 V	100 ms	60 s
Voltage decrease protection	U<	U ₋	0,8 * Un	80 % Un	184 V	3,0 s	60 s
Voltage decrease protection	U<<	U ₋ -	0,45 * Un	45 % Un	103 V	300 ms	60 s
Frequency increase protection	f>	F ⁻			51,5 Hz	100 ms	60 s
Frequency decrease protection	f<	F ₋			47,5 Hz	100 ms	60 s
Switching conditions		UF _{on}			off		

21 Adjustment values (VDE-AR-N 4110:2018-11 Medium Voltage / VDE-AR-N 4120:2018-11 High Voltage) higher protection Pr 11+12

Acc. to 10.3.5.3 table 12, higher protection device

Funktion	AR 4110	ZIEHL	Adjustment range of the protective relay	Default settings	
Voltage increase protection	U>>	U ⁻ -	1,00 – 1,30 U _n	1,2 U _n	300 ms
Voltage increase protection	U>	U ⁻	1,00 – 1,30 U _n	1,1 U _n	180 s
Voltage decrease protection	U<	U ₋	0,10 – 1,00 U _n	0,80 U _n	2,7 s
Frequency increase protection *	f>	F ⁻	50,0 – 65,0 Hz	51,5 Hz	5,4 s
Frequency decrease protection *	f<	F ₋	45,0 – 50,0 Hz	47,5 Hz	400 ms
Switching conditions		UF _{on}		off	

* Not enabled in as delivered condition

22 Adjustment values VDE-AR-N 4110:2018-11, Medium Voltage Unit Protection Pr 13+14

Acc. to 10.3.5.3 table 13, protection at the generating units

Funktion	AR 4110	ZIEHL	Adjustment range of the protective relay	Default settings	
Voltage increase protection	$U_{>>}$	U^{--}	$1,00 - 1,30 U_n$	$1,25 U_n$	100 ms
Voltage decrease protection	$U_{<}$	U_{-}	$0,10 - 1,00 U_n$	$0,80 U_n$	1,0 s
Voltage decrease protection	$U_{<<}$	U_{--}	$0,10 - 1,00 U_n$	$0,45 U_n$	300 ms
Frequency increase protection	$f_{>>}$	F^{--}	50,0 – 65,0 Hz	52,5 Hz	100 ms
Frequency increase protection	$f_{>}$	F_{-}	50,0 – 65,0 Hz	51,5 Hz	5,0 s
Frequency decrease protection	$f_{<}$	F_{-}	45,0 – 50,0 Hz	47,5 Hz	100 ms
Switching conditions		UF_{on}		on	