

## PV Grid Tie Inverter

# Solis 4G Mini Single Phase Inverter

### Installation and Operation Manual

Solis-mini-700-4G, Solis-mini-1000-4G, Solis-mini-1500-4G, Solis-mini-2000-4G,  
Solis-mini-2500-4G, Solis-mini-3000-4G, Solis-mini-3600-4G, Solis-mini-1000-4G-LV

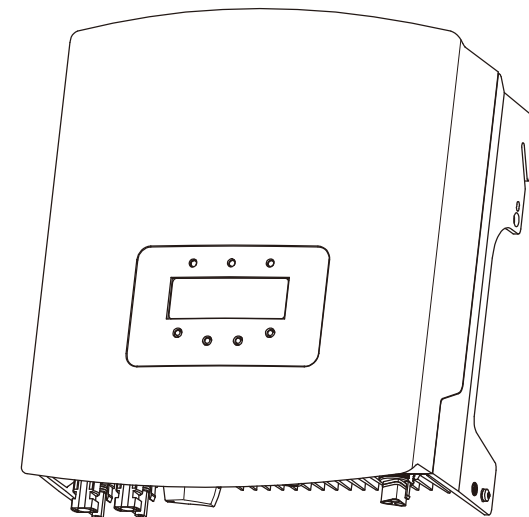

Ningbo Ginlong Technologies Co., Ltd.

No. 57 Jintong Road, Binhai Industrial Park, Xiangshan, Ningbo,  
Zhejiang, 315712, P.R.China.

Tel: +86 (0)574 6578 1806

Fax: +86 (0)574 6578 1606

Email: info@ginlong.com

Web: www.ginlong.com

If you encounter any problem on the inverter, please find out the inverter S/N  
and contact us, we will try to respond to your question ASAP.



© Ningbo Ginlong Technologies Co., Ltd.

# Contents

1. Introduction	3
1.1 Product Description	3
1.2 Packaging	4
2. Safety Instructions	5
2.1 Safety Symbols	5
2.2 General Safety Instructions	5
2.3 Notice For Use	6
3. Overview	7
3.1 Front Panel Display	7
3.2 LED Status Indicator Lights	7
3.3 Keypad	8
3.4 LCD	8
4. Installation	9
4.1 Select Location for the Inverter	9
4.2 Mounting the Inverter	11
4.3 Electrical Connections	13
4.3.1 Connect PV side of inverter	13
4.3.2 Connect grid side of inverter	16
4.3.3 External ground connection	18
4.3.4 Max. overcurrent protection device (OCPD)	19
4.3.5 Inverter monitoring connection	19
4.3.6 Electrical connection diagram	20
4.3.7 Meter Connection(Only for AUS.)	20
4.3.8 CT connections(optional)	21
4.3.9 DRED port connections(Only for AUS.)	21
5. Start & Stop	23
5.1 Start the Inverter	23
5.2 Stop the Inverter	23
6. Operation	24
6.1 Main Menu	24
6.2 Information	24
6.2.1 Lock screen	26

# Contents

6.3 Settings	26
6.3.1 Set Time	26
6.3.2 Set Address	26
6.4 Advanced Info.	27
6.4.1 Alarm Message	27
6.4.2 Running Message	28
6.4.3 Version	28
6.4.4 Daily Energy	28
6.4.5 Monthly Energy and Yearly Energy	28
6.4.6 Daily Record	29
6.4.7 Communication Data	29
6.4.8 Warning Message	29
6.5 Advanced Settings	29
6.5.1 Select Standard	30
6.5.2 Grid ON/OFF	31
6.5.3 Clear Energy	31
6.5.4 Reset Password	31
6.5.5 Power Control	31
6.5.6 Calibrate Energy	32
6.5.7 Special Settings	32
6.5.8 STD. Mode Settings	32
6.5.9 Restore Settings	34
6.5.10 HMI Update	34
6.5.11 Export Power Set	34
6.5.12 Restart HMI	38
6.5.13 Debug Parameter	38
6.5.14 DSP Update	38
6.5.15 Power Parameter	38
7. Maintenance	39
8. Troubleshooting	39
9. Specifications	42

# 1. Introduction

## 1.1 Product Description

Solis 4G mini series single phase inverters integrate DRM and backflow power control function, that could suitable for smart grid requirement.

Mini Single phase 4G series inverter contain 8 models which are listed below:

Solis-mini-700-4G, Solis-mini-1000-4G, Solis-mini-1500-4G, Solis-mini-2000-4G, Solis-mini-2500-4G, Solis-mini-3000-4G, Solis-mini-3600-4G, Solis-mini-1000-4G-LV

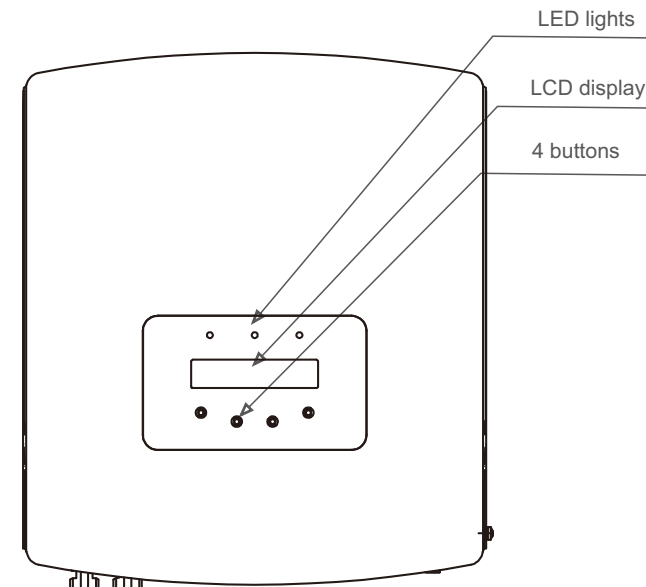

▲ Figure 1.1 Front side view

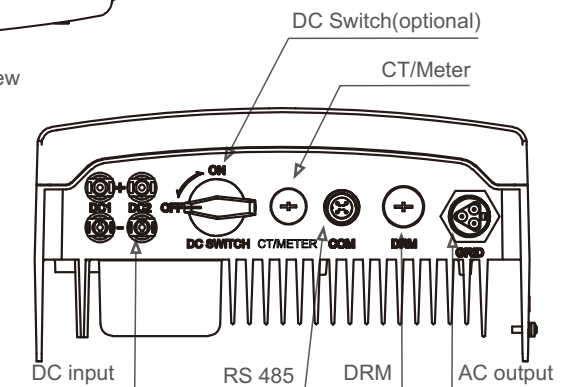

▲ Figure 1.2 Bottom side view

# 1. Introduction

# 2. Safety Instructions

## 1.2 Packaging

When you receive the inverter, ensure that all the parts listed below are included:

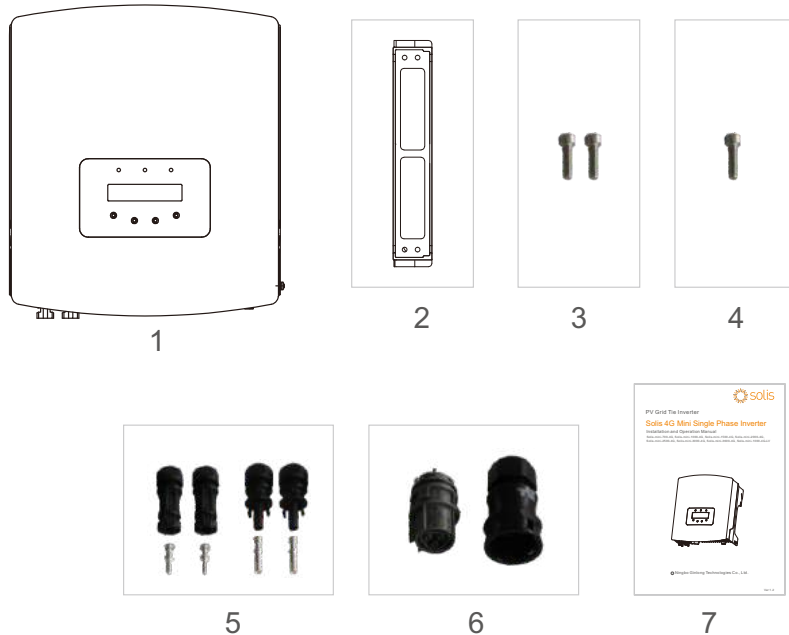

Part #	Description	Number
1	PV grid tie inverter	1
2	Wall/pole bracket	1
3	Locking screws	2
4	Grounding screw (attached in ground point at side of inverter)	1
5	DC connector	1 pair (3.6kW is 2 pairs)
6	AC connector	1
7	Manual	1
8	CT with cable or Meter	1

▲ Table 1.1 Parts list

Improper use may result in potential electric shock hazards or burns. This manual contains important instructions that should be followed during installation and maintenance. Please read these instructions carefully before use and keep them for future reference.

## 2.1 Safety Symbols

Safety symbols used in this manual, which highlight potential safety risks and important safety information, are listed as follows:



### WARNING:

WARNING symbol indicates important safety instructions, which if not correctly followed, could result in serious injury or death.



### NOTE:

NOTE symbol indicates important safety instructions, which if not correctly followed, could result in some damage or the destruction of the inverter.



### CAUTION:

CAUTION, RISK OF ELECTRIC SHOCK symbol indicates important safety instructions, which if not correctly followed, could result in electric shock.



### CAUTION:

CAUTION, HOT SURFACE symbol indicates safety instructions, which if not correctly followed, could result in burns.

## 2.2 General Safety Instructions



### WARNING:

Only devices in compliance with SELV (EN 69050) may be connected to the RS485 and USB interfaces.



### WARNING:

Please don't connect PV array positive(+) or negative(-) to ground, it could cause serious damage to the inverter.



### WARNING:

Electrical installations must be done in accordance with the local and national electrical safety standards.



### WARNING:

Do not touch any inner live parts until 5 minutes after disconnection from the utility grid and the PV input.

## 2. Safety Instructions

## 3. Overview



### WARNING:

To reduce the risk of fire, over-current protective devices (OCPD) are required for circuits connected to the Inverter. The DC OCPD shall be installed per local requirements. All photovoltaic source and output circuit conductors shall have disconnects that comply with the NEC Article 690, Part II. All Solis single phase inverters feature an integrated DC switch.



### CAUTION:

Risk of electric shock. Do not remove cover. There is no user serviceable parts inside. Refer servicing to qualified and accredited service technicians.



### CAUTION:

The PV array (Solar panels) supplies a DC voltage when they are exposed to sunlight.



### CAUTION:

Risk of electric shock from energy stored in capacitors of the Inverter. Do not remove cover for 5 minutes after disconnecting all power sources (service technician only). Warranty may be voided if the cover is removed without authorization.



### CAUTION:

The surface temperature of the inverter can reach up to 75°C (167 F). To avoid risk of burns, do not touch the surface of the inverter while it's operating. Inverter must be installed out of the reach of children.



PV module used with inverter must have an IEC 61730 Class A rating.

### 2.3 Notice For Use

The inverter has been constructed according to the applicable safety and technical guidelines. Use the inverter in installations that meet the following specifications ONLY:

1. Permanent installation is required.
2. The electrical installation must meet all the applicable regulations and standards.
3. The inverter must be installed according to the instructions stated in this manual.
4. The inverter must be installed according to the correct technical specifications.
5. To startup the inverter, the Grid Supply Main Switch (AC) must be switched on, before the solar panel's DC isolator shall be switched on. To stop the inverter, the Grid Supply Main Switch (AC) must be switched off before the solar panel's DC isolator shall be switched off.

### 3.1 Front Panel Display

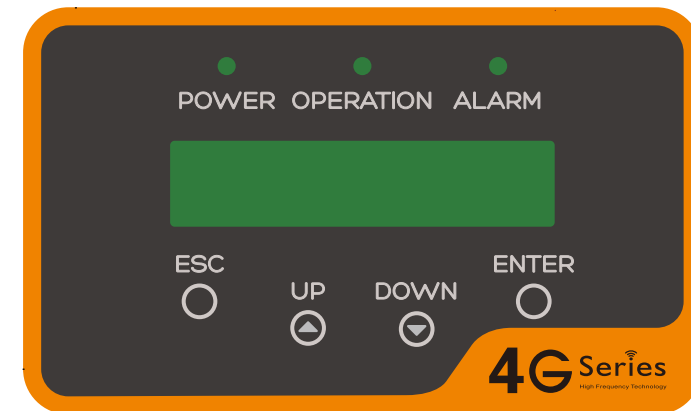

▲ Figure 3.1 Front Panel Display

### 3.2 LED Status Indicator Lights

There are three LED status indicator lights in the front panel of the inverter. Left LED: POWER LED (red) indicates the power status of the inverter. Middle LED: OPERATION LED (green) indicates the operation status. Right LED: ALARM LED (yellow) indicates the alarm status. Please see Table 3.1 for details

Light	Status	Description
● POWER	ON	The inverter can detect DC power
	OFF	No DC power or low DC power
● OPERATION	ON	The inverter is operating properly.
	OFF	The inverter has stopped to supply power.
	FLASHING	The inverter is initializing.
● ALARM	ON	Alarm or fault condition is detected.
	OFF	The inverter is operating properly.

▲ Table 3.1 Status Indicator Lights

## 3. Overview

### 3.3 Keypad

There are four keys in the front panel of the Inverter(from left to right): ESC, UP, DOWN and ENTER keys. The keypad is used for:

- Scrolling through the displayed options (the UP and DOWN keys);
- Access to modify the adjustable settings (the ESC and ENTER keys).

### 3.4 LCD

The two-line Liquid Crystal Display (LCD) is located on the front panel of the Inverter, which shows the following information:

- Inverter operation status and data;
- Service messages for operator;
- Alarm messages and fault indications.

## 4. Installation

### 4.1 Select a Location for the Inverter

To select a location for the inverter, the following criteria should be considered:

- Do not install in small closed spaces where air can not circulate freely. To avoid overheating, always make sure the flow of air around the inverter is not blocked.
- Exposure to direct sunlight will increase the operational temperature of the inverter and may cause output power limiting. Ginlong recommends inverter installed to avoid direct sunlight or raining.
- To avoid over heating ambient air temperature must be considered when choosing the inverter installation location. Ginlong recommends using a sun shade minimizing direct sunlight when the ambient air temperature around the unit exceeds 104°F/40°C.



▲ Figure 4.1 Recommended Installation Locations

# 4. Installation

- Install on a wall or strong structure capable of bearing the weight.
- Install vertically with a maximum incline of  $\pm 5^\circ$ . If the mounted inverter is tilted to an angle greater than the maximum noted, heat dissipation can be inhibited, and may result in less than expected output power.
- When 1 or more inverters are installed in one location, a minimum 12inches clearance should be kept between each inverter or other object. The bottom of the inverter should be 20inches clearance to the ground.

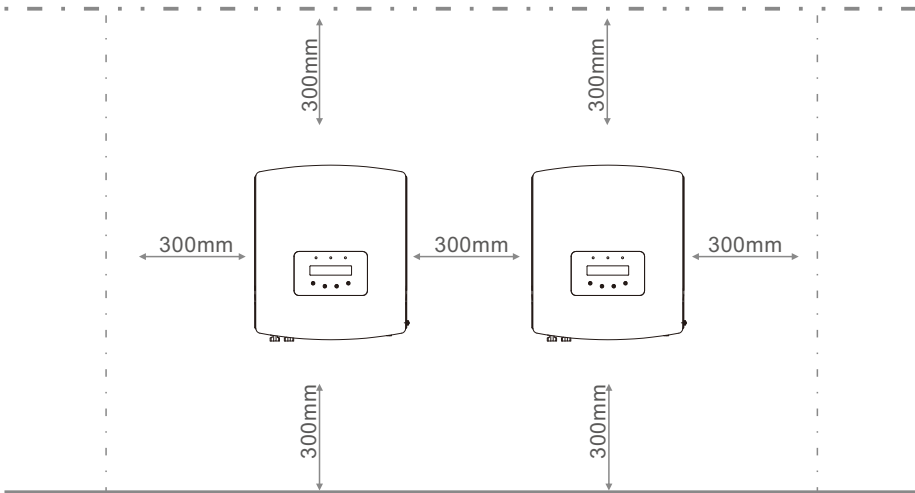

▲ Figure 4.2 Inverter Mounting clearance

- Visibility of the LED status indicator lights and the LCD located at the front panel of the inverter should be considered.
- Adequate ventilation must be provided if the inverter is to be installed in a confined space.



**NOTE:**

Nothing should be stored on or placed against the inverter.

# 4. Installation

## 4.2 Mounting the Inverter

Dimensions of wall bracket:

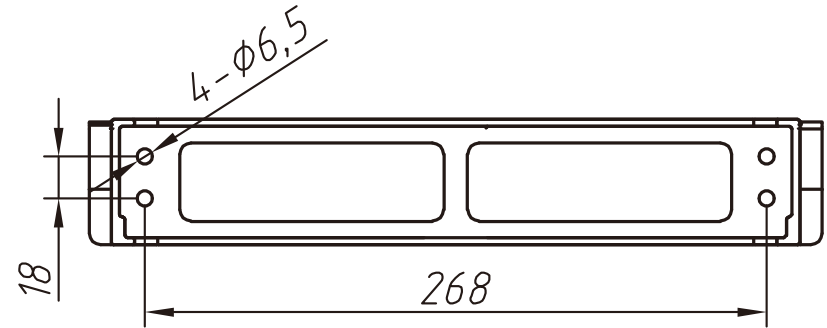

▲ Figure 4.3 Inverter wall mounting

Please see Figure 4.4 and Figure 4.5 for instruction on mounting the inverter.

The inverter shall be mounted vertically. The steps to mount the inverter are listed below:

1. According to the figure 4.2, select the mounting height of the bracket and mark the mounting holes. For brick walls, the position of the holes should be suitable for the expansion bolts.

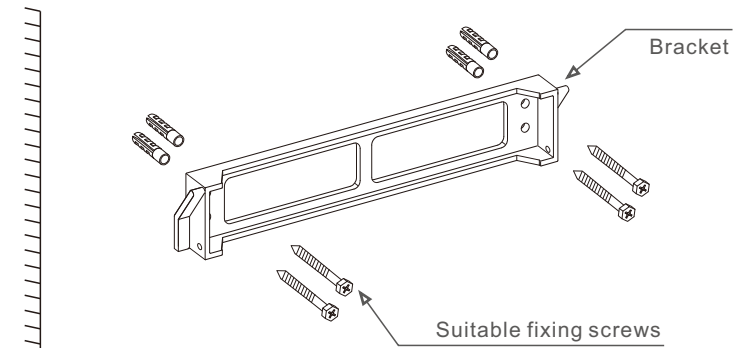

▲ Figure 4.4 Inverter wall mounting

# 4. Installation

2. Make sure the bracket is horizontal and the mounting holes (in Figure 4.4) are marked correctly. Drill the holes into the wall or pillar at your marks.
3. Use the suitable screws to fix the bracket to the wall.



**WARNING:**

The inverter must be mounted vertically.

4. Lift up the inverter (be careful to avoid body strain), and align the back bracket on the inverter with the convex section of the mounting bracket. Hang the inverter on the mounting bracket and make sure the inverter is secure (see Figure 4.5).

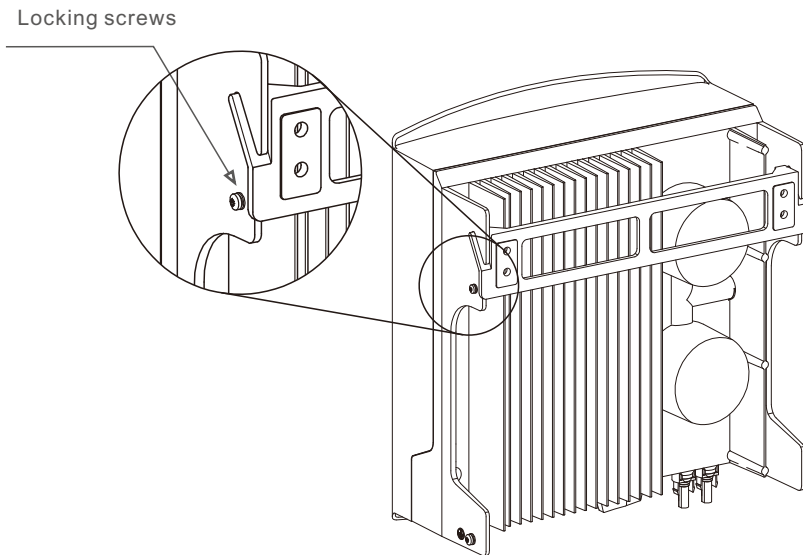

▲ Figure 4.5 Wall Mount Bracket

5. Use M4\*9 screws in accessory to lock the inverter to the mount bracket.

# 4. Installation

## 4.3 Electrical Connections

### 4.3.1 Connect PV side of inverter

The electrical connection of the inverter must follow the steps listed below:

1. Switch the Grid Supply Main Switch (AC) OFF.
2. Switch the DC Isolator OFF.
3. Assemble PV input connector to the Inverter.



Before connecting inverter, please make sure the PV array open circuit voltage is within the limit of the inverter

**Maximum 600Voc for**

Solis-mini-700-4G, Solis-mini-1000-4G, Solis-mini-1500-4G,  
Solis-mini-2000-4G, Solis-mini-2500-4G, Solis-mini-3000-4G,  
Solis-mini-3600-4G, Solis-mini-1000-4G-LV



Please don't connect PV array positive or negative pole to the ground, it could cause serious damages to the inverter



Before connection, please make sure the polarity of the output voltage of PV array matches the "DC+" and "DC-" symbols.

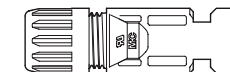
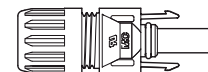

▲ Figure 4.6 DC+ Connector

▲ Figure 4.7 DC- Connector



# 4. Installation

# 4. Installation



Please use approved DC cable for PV system.

Cable type	Cross section	
	Range	Recommended value
Industry generic PV cable (model:PV1-F)	4.0~6.0 (12~10AWG)	4.0 (12AWG)

▲ Table 4.1 DC cable

The steps to assemble the DC connectors are listed as follows:

i) Strip off the DC wire for about 7mm, Disassemble the connector cap nut.

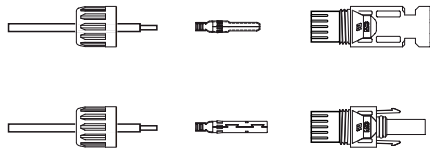

▲ Figure 4.8 Disassemble the Connector Cap nut

ii) Insert the wire into the connector cap nut and contact pin.

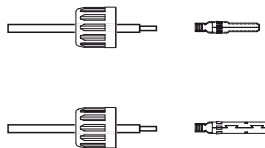

▲ Figure 4.9 Insert the Wire into the Connector Cap nut and contact pin

iii) Crimp the contact pin to the wire using a proper wire crimper.

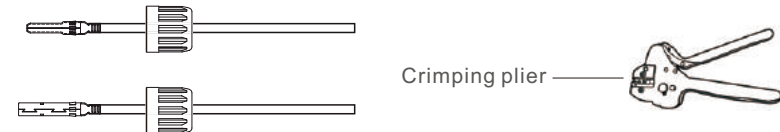

▲ Figure 4.10 Crimp the contact pin to the wire

iv) Insert the contact pin to the top part of the connector and screw up the cap nut to the top part of the connector.

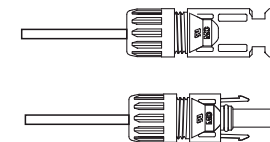

▲ Figure 4.11 Connector with Cap nut Screwed on

v) Then connect the DC connectors to the inverter. Small click will confirm connection.

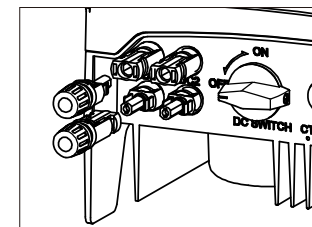

▲ Figure 4.12 Connect the DC Connectors to the Inverter

# 4. Installation

# 4. Installation

## 4.3.2 Connect grid side of inverter

For all AC connections, 2.5- 6mm<sup>2</sup> 105 °C cable is required to be used. Please make sure the resistance of cable is lower than 1 ohm. If the wire is longer than 20m, it's recommended to use 6mm<sup>2</sup> cable.



**WARNING:**

There are “L” “N” “⏏” symbols marked inside the connector, the Line wire of grid must be connected to “L” terminal; the Neutral wire of grid must be connected to “N” terminal; the Earth of grid must be connected to “⏏” (see Figure 4.13).

Cable type	Cross section	
	Range	Recommended value
Industry generic grid cable	2.5~6.0mm <sup>2</sup>	6mm <sup>2</sup>

▲ Table 4.2 Grid cable size



▲ Figure 4.13 AC Grid Terminal Connector Inside

Each Solis Mini Single Phase Inverter is supplied with an AC grid terminal connector.



▲ Figure 4.14 AC Grid Terminal Connector

The steps to assemble the AC grid terminal connectors are listed as follows:

- a) Disassemble the AC connector. Strip the AC wires about 6mm.

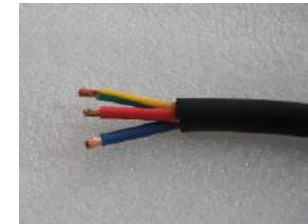

▲ Figure 4.15 Stripped AC Wires

- b) Fix the green and yellow wire to the ground terminal. Fix the red(or brown) wire to L (line) terminal. Fix the blue wire to N(Neutral). Tight the screws on the connector. Please try to pull out the wire to make sure the it's well connected.



▲ Figure 4.16 Connect Wires to the Terminal

- c) Tighten up the cap on the terminal (see Figure 4.17).



▲ Figure 4.17 Tighten up the Cap on the Terminal

# 4. Installation

d) Connect the AC grid terminal connector to the inverter. Small click will confirm connection.



▲ Figure 4.18 Connect the AC Connector to the Inverter



**Note: Connection for Split phase grid.**

When connect to 208/220/240V split phase, please connect L1 to “L” terminal, L2 to “N” terminal. Also connect earth to ground terminal.

## 4.3.3 External ground connection

An external ground connection is provided at the right side of inverter. Prepare OT terminals: M4. Use proper tooling to crimp the lug to the terminal.

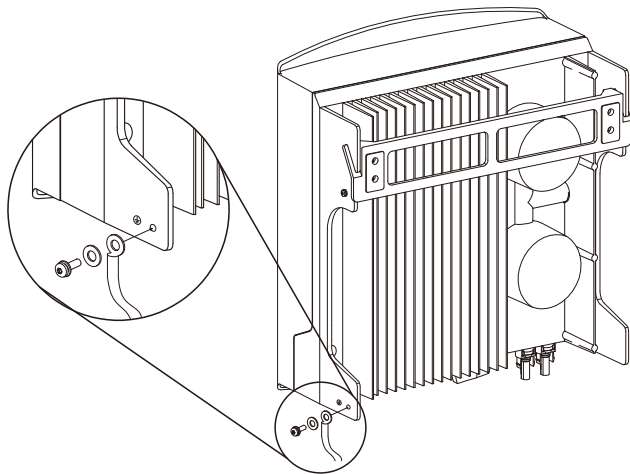

▲ Figure4.19 Connect the external grounding conductor

# 4. Installation

## 4.3.4 Max. over current protection device (OCPD)

To protect the inverter's AC grid connection conductors, Solis recommends installing breakers that will protect against overcurrent. The following table defines OCPD ratings for the Solis mini single phase inverters.

Inverter	Rated voltage(V)	Rated output current (A)	Current for protection device (A)
Solis-mini-700-4G	220/230	3.2/3.0	10
Solis-mini-1000-4G	220/230	4.5/4.3	10
Solis-mini-1500-4G	220/230	6.8/6.5	10
Solis-mini-2000-4G	220/230	9.1/8.7	15
Solis-mini-2500-4G	220/230	11.4/10.9	15
Solis-mini-3000-4G	220/230	13.6/13	20
Solis-mini-3600-4G	220/230	16	20
Solis-mini-1000-4G-LV	101/120/127	8.3	15

▲ Table 4.3 Rating of grid OCPD

## 4.3.5 Inverter monitoring connection

The inverter can be monitored via Wi-Fi or GPRS. All Solis communication devices are optional (Figure 4.20). For connection instructions, please refer to the Solis Monitoring Device installation manuals.

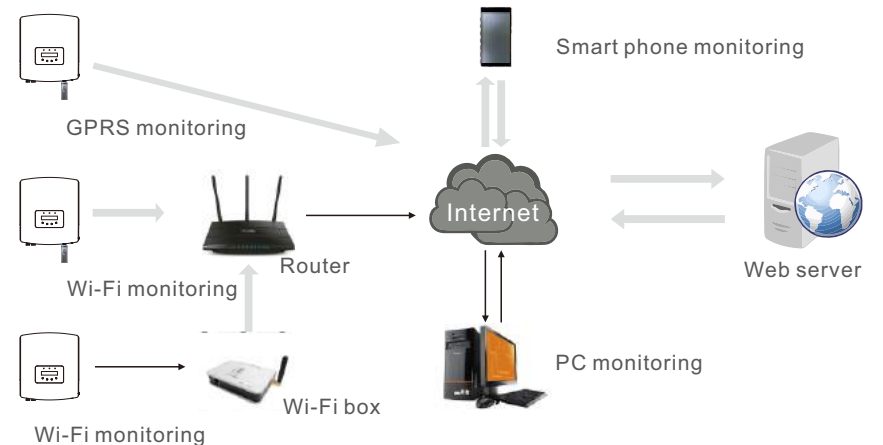

▲ Figure4.20 Communication function

# 4. Installation

# 4. Installation

## 4.3.6 Electrical connection diagram

Refer to figure 4.21, which is a simple guidance for installing a solar system with PV inverter. A DC isolator is required to be installed in the system between PV panels with inverter.

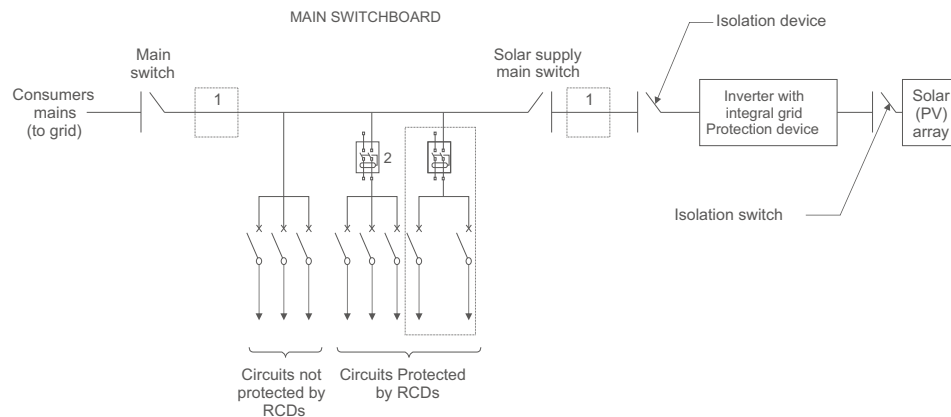

▲ Figure 4.21 Guidance for a Simple Installation of an Inverter Solar Energy System

1. The RCD should be in parallel connection between the consumers mains and the solar supply.
2. More than one RCD may be used. Each RCD can protect one or more circuits.

## 4.3.7 Meter Connection(Only for Australia)

The inverter has intergrated export limitation functionality.

To use this function, a power meter must be installed, if use the power meter, it should be installed in the load side or in the grid side, see Figure 4.22 and 4.23. After the inverter power on, please set the corresponding configuration as sections 6.5.11.1.2 and 6.5.11.1.3.

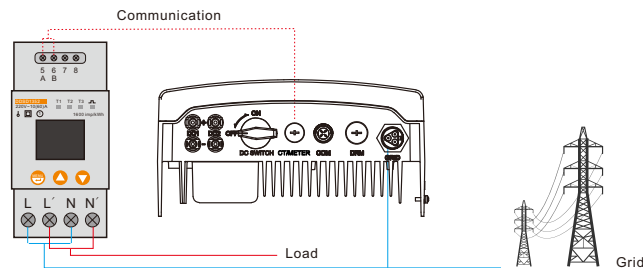

▲ Figure 4.22 Meter in Load

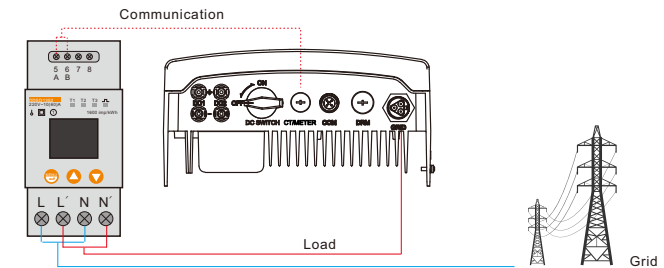

▲ Figure 4.23 Meter in Grid

## 4.3.8 CT connections(optional)

This inverter has integrated export limitation functionality. To use this function, a CT must be installed, if use the CT, please reference below picture. The CT should be fitted around the live conductor on the grid side of the main incoming consumer unit. Use the directional flow indication arrow on the CT to ensure it is fitted in the correct orientation. The arrow should be pointing towards the grid, not the load. when the inverter power on, please set the corresponding configuration as sections 6.5.11.1.4.1 and 6.5.11.1.4.2.

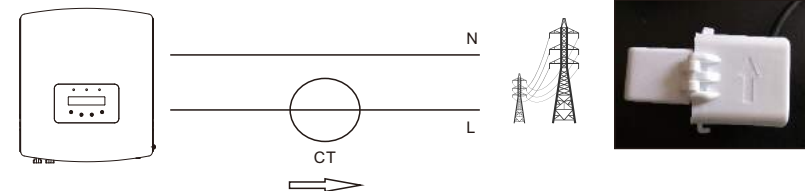

▲ Figure 4.24 Direction of CT

## 4.3.9 DRED port connections(Only for Australia)

DRED means demand response enable device. The AS/NZS 4777.2:2015 required inverter need to support demand response mode(DRM). This function is for inverter that comply with AS/NZS 4777.2:2015 standard. Solis 4G single phase inverter is fully comply with all DRM. A RJ45 terminal is used for DRM connection.

Pin	Assignment for inverters capable of both charging and discharging	Pin	Assignment for inverters capable of both charging and discharging
1	DRM 1/5	5	RefGen
2	DRM 2/6	6	Com/DRM0
3	DRM 3/7	7	V+
4	DRM 4/8	8	V-

## 4. Installation



### NOTE:

Solis 4G inverter is designed to provide 12V power for DRED.

Please follow below steps to assemble RJ45 connector.

1. Insert the network cable into the communication connection terminal of RJ45.  
(As shown in figure 4.25)



▲ Figure 4.25 RJ45 communication connection terminals

2. Use the network wire stripper to strip the insulation layer of the communication cable. According to the standard line sequence of figure 4.26 connect the wire to the plug of RJ45, and then use a network cable crimping tool to make it tight.

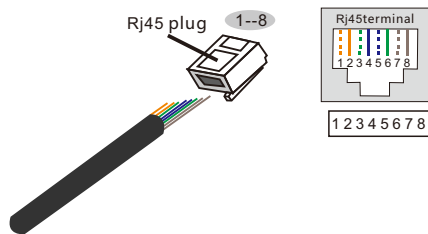

### Correspondence between the cables and the stitches of plug

Pin 1: white and orange ; Pin 2: orange  
Pin 3: white and green ; Pin 4: blue  
Pin 5: white and blue ; Pin 6: green  
Pin 7: white and brown ; Pin 8: brown

▲ Figure 4.26 Strip the insulation layer and connect to RJ45 plug

3. Connect RJ45 to DRM port.

## 5. Start & Stop

### 5.1 Start the Inverter

To start up the Inverter, it is important that the following steps are strictly followed:

1. Switch the grid supply main Switch (AC) ON first.
2. Switch the DC switch ON. If the voltage of PV arrays are higher than start up voltage, the inverter will turn on. The red LED power will light.
3. When both the DC and the AC sides supply to the inverter, it will be ready to generate power. Initially, the inverter will check both its internal parameters and the parameters of the AC grid, to ensure that they are within the acceptable limits. At the same time, the green LED will flash and the LCD displays the information of INITIALIZING.
4. After 30-300 seconds (depending on local requirement), the inverter will start to generate power. The green LED will be on continually and the LCD displays GENERATING.



### WARNING:

Do not touch the surface when the inverter is operating. It may be hot and cause burns.

#### 5.1.1 Inverter working status

When inverter working normally, there would be 5 status :

- Generating: Inverter is working normally
- LimByTemp: Inverter power limited by over ambient temperature.
- LimByFreq: Inverter power limited by over grid frequency
- LimByVg: Inverter power limited by over grid voltage
- LimByVar: Inverter power limited by generating reactive power.

### 5.2 Stop the Inverter

To stop the Inverter, the following steps must be strictly followed:

1. Switch the Supply Main Switch (AC) OFF.
2. Wait 30 seconds. Switch the DC Switch OFF. All the LEDs of the inverter will be off in one minute.

During normal operation, the display alternately shows the power and the operation status with each screen lasting for 10 seconds (see Figure 6.1). Screens can also be scrolled manually by pressing the UP and DOWN keys. Press the ENTER key to access to the Main Menu.

# 6. Operation

# 6. Operation

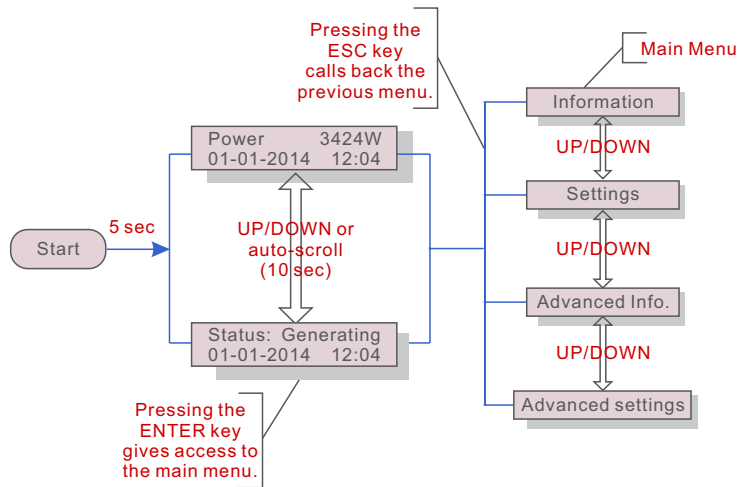

▲ Figure 6.1 Operation Overview

## 6.1 Main Menu

There are four submenus in the Main Menu (see Figure 6.1):

1. Information
2. Settings
3. Advanced Info.
4. Advanced Settings

## 6.2 Information

The Solis Single Phase 4G Inverter main menu provides access to operational data and information. The information is displayed by selecting "Information" from the menu and then by scrolling up or down.

Display	Duration	Description
V_DC1 350.8V I_DC1 5.1A	10 sec	V_DC1: Shows input 01 voltage value. I_DC1: Shows input 01 current value.
V_Grid 230.4V I_Grid 8.1A	10 sec	V_Grid: Shows the grid's voltage value I_Grid: Shows the grid's current value.
Status: Generating Power: 1488W	10 sec	Status: Shows instant status of the Inverter. Power: Shows instant output power value.
Grid Frequency F_Grid 60.06Hz	10 sec	F_Grid: Shows the grid's frequency value.
Total Energy 0258458 kwh	10 sec	Total generated energy value
This Month: 0123kwh Last Month: 0123kwh	10 sec	This Month: Total energy generated this month. Last Month: Total energy generated last month.
Today: 15.1kwh Yesterday: 13.5kwh	10 sec	Today: Total energy generated today. Yesterday: Total energy generated yesterday.
Inverter SN 00000000000000	10 sec	Display series number of the inverter.
Export_P: +0000W Export_I: 00.0A	10 sec	Power of ERM. Current of EPM.
Work Mode: NULL DRM Number: 08	10 sec	Work Mode: The work mode of inverter. DRM Number: Show the number 01-08.
Meter EnergyP 000000.00kWh	10 sec	Meter EnergyP: The active power.

▲ Table 6.1 Information list

# 6. Operation

# 6. Operation

## 6.2.1 Lock screen

Pressing the ESC key returns to the Main Menu. Pressing the ENTER key locks (Figure 6.2(a)) or unlocks (Figure 6.2 (b)) the screen.



▲ Figure 6.2 Locks and Unlocks the Screen of LCD

## 6.3 Settings

The following submenus are displayed when the Settings menu is selected:

- 1.Set Time
- 2.Set Address

### 6.3.1 Set Time

This function allows time and date setting. When this function is selected, the LCD will display a screen as shown in Figure 6.3.



▲ Figure 6.3 Set Time

Press the UP/DOWN keys to set time and data. Press the ENTER key to move from one digit to the next (from left to right). Press the ESC key to save the settings and return to the previous menu.

### 6.3.2 Set Address

This function is used to set the address when muti inverters are connected to single monitor. The address number can be assigned from "01"to "99"(see Figure 6.4). The default address number of Solis Single Phase Inverter is "01".



▲ Figure 6.4 Set Address

Press the UP/DOWN keys to set the address. Press the ENTER key to save the settings. Press the ESC key to cancel the change and return to the previous menu.

## 6.4 Advanced Info - Technicians Only



### NOTE:

To access to this area is for fully qualified and accredited technicians only. Enter menu "Advanced Info." and "Advanced settings" (need password) .

Select "Advanced Info." from the Main Menu. The screen will require the password as below



▲ Figure 6.5 Enter password

The default password is "0010". Please press "down" to move the cursor, press "up" to select the number.

After enter the correct password the Main Menu will display a screen and be able to access to the following information.

- 1.Alarm Message
2. Running Message
- 3.Version
4. Daily Energy
5. Monthly Energy
6. Yearly Energy
7. Daily Record
- 8.Communication Data
9. Warning Message

The screen can be scrolled manually by pressing the UP/DOWN keys. Pressing the ENTER key gives access to a submenu. Press the ESC key to return to the Main Menu.

### 6.4.1 Alarm Message

The display shows the 100 latest alarm messages (see Figure 6.6). Screens can be scrolled manually by pressing the UP/ DOWN keys. Press the ESC key to return to the previous menu.



▲ Figure 6.6 Alarm Message

# 6. Operation

# 6. Operation

## 6.4.2 Running Message

This function is for maintenance person to get running message such as internal temperature, Standard NO. etc.

Screens can be scrolled manually by pressing the UP/DOWN keys.

## 6.4.3 Version

The screen shows the model version and the software version of the Inverter (see Figure 6.7).



Model: 08  
Software Version: D20001

▲ Figure 6.7 Model Version and Software Version

## 6.4.4 Daily Energy

The function is for checking the energy generation for selected day.



YES=<ENT> NO=<ESC>  
Select: 2015-02-23

▲ Figure 6.8 Select date for daily energy

Press DOWN key to move the cursor to day, month and year, press UP key to change the digit. Press Enter after the date is fixed.

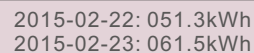

2015-02-22: 051.3kWh  
2015-02-23: 061.5kWh

▲ Figure 6.9 Daily energy

Press UP/DOWN key to move one date from another.

## 6.4.5 Monthly Energy and Yearly Energy

The two functions are for checking the energy generation for selected month and Year

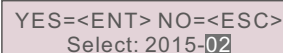

YES=<ENT> NO=<ESC>  
Select: 2015-02



YES=<ENT> NO=<ESC>  
Select: 2015

▲ Figure 6.10 Select month for monthly energy ▲ Figure 6.11 Select year for yearly energy

Press DOWN key to move the cursor, press UP key to change the digit.

Press Enter after the month/year is fixed.

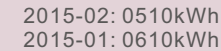

2015-02: 0510kWh  
2015-01: 0610kWh

▲ Figure 6.12 Month energy



2015: 0017513kWh  
2014: 0165879kWh

▲ Figure 6.13 Yearly energy

Press UP/DOWN key to move one date from another.

## 6.4.6 Daily record

The screen shows history of changing settings. Only for maintenance personnel.

## 6.4.7 Communication Data

The screen shows the internal data of the Inverter (see Figure 6.14), which is for service technicians only.

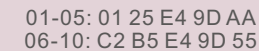

01-05: 01 25 E4 9D AA  
06-10: C2 B5 E4 9D 55

▲ Figure 6.14 Communication Data

## 6.4.8 Warning Message

The display shows the 100 latest warn messages (see Figure 6.15). Screens can be scrolled manually by pressing the UP/ DOWN keys. Press the ESC key to return to the previous menu.

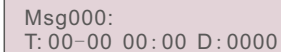

Msg000:  
T: 00-00 00:00 D: 0000

▲ Figure 6.15 Warning Message

## 6.5 Advanced Settings - Technicians Only



### NOTE:

To access to this area is for fully qualified and accredited technicians only. Please follow 6.4 to enter password to access this menu.

Select Advanced Settings from the Main Menu to access the following options:

1. Select Standard
2. Grid ON/OFF
3. Clear Energy
4. Reset Password
5. Power Control
6. Calibrate Energy
7. Special Settings
8. STD. Mode Settings
9. Restore Settings
10. HMI Update
11. Export Power Set
12. Restart HMI
13. Debug Parameter
14. DSP Update
15. Power Parameter



# 6. Operation

# 6. Operation

## 6.5.1 Selecting Standard

This function is used to select the grid's reference standard (see Figure 6.16).

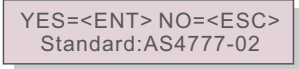

▲ Figure 6.16

Press the UP/DOWN keys to select the standard (AS4777-02,AS4777-15, VDE4105, VDE0126, UL-240V-A, UL-208V-A, UL-240V, UL-208V, MEX-CFE, G83/2 (for 1-3.6kW models), G59/3 (for 4-5kW models), EN50438 DK, EN50438 IE, EN50438 NL and "User-Def" function). Press the ENTER key to confirm the setting. Press the ESC key to cancel changes and returns to previous menu.



**NOTE:**

This function is for technicians use only.

Selecting the "User-Def" menu will access to the following submenu (see Figure 6.17),



▲ Figure 6.17



**NOTE:**

The "User-Def" function can be only used by the service engineer and must be allowed by the local energy supplier.

Below is the setting range for "User-Def". Using this function, the limits can be changed manually.

OV-G-V1: 240---270V	OV-G-F1: 50.2-53Hz(60.2-64Hz)
OV-G-V1-T: 0.1---9S	OV-G-F1-T: 0.1---9S
OV-G-V2: 240---300V	OV-G-F2: 50.2-53Hz(60.2-64Hz)
OV-G-V2-T: 0.1---1S	OV-G-F2-T: 0.1---9S
UN-G-V1: 170---210V	UN-G-F1: 47-49.5Hz(56-59.8Hz)
UN-G-V1-T: 0.1---9S	UN-G-F1-T: 0.1---9S
UN-G-V2: 110---210V	UN-G-F2: 47-49Hz(56-59.8Hz)
UN-G-V2-T: 0.1---1S	UN-G-F2-T: 0.1---9S
Startup-T: 10-600S	Restore-T: 10-600S

Press the UP/DOWN keys to scroll through items. Press the ENTER key to edit the highlighted item. Press the UP/DOWN keys again to change the setting. Press the ENTER key to save the setting. Press the ESC key to cancel changes and returns to the previous menu.

## 6.5.2 Grid ON/OFF

This function is used to start up or stop the power generation of Solis Single Phase Inverter (see Figure 6.18).



▲ Figure 6.18 Set Grid ON/OFF

Screens can be scrolled manually by pressing the UP/DOWN keys. Press the ENTER key to save the setting. Press the ESC key to return to the previous menu.

## 6.5.3 Clear Energy

Clear Energy can reset the history yield of inverter



These two functions are applicable by maintenance personnel only, wrong operation will prevent the inverter from working properly.

## 6.5.4 Reset Password

This function is used to set the new password for menu "Advanced info." and "Advanced information" (see Figure 6.19).



▲ Figure 6.19 Reset password

Enter the right password before set new password. Press the DOWN key to move the cursor, Press the UP key to revise the value. Press the ENTER key to execute the setting. Press the ESC key to return to the previous menu.

## 6.5.5 Power Control

Active and reactive power can be set through power setting button.

There are 5 item for this sub menu:

1. Set output power
2. Set Reactive Power
3. Out\_P With Restore
4. Rea\_P With Restore
5. Select PF Curve



This function is applicable by maintenance personnel only, wrong operation will prevent the inverter from reaching maximum power.

# 6. Operation

# 6. Operation

## 6.5.6 Calibrate Energy

Maintenance or replacement could clear or cause a different value of total energy. Use this function could allow user to revise the value of total energy to the same value as before. If the monitoring website is used the data will be synchronous with this setting automatically. (see Figure 6.20).

```
YES=<ENT> NO=<ESC>
Energy:0000000kWh
```

▲ Figure 6.20 Calibrate energy

Press the DOWN key to move the cursor, Press the UP key to revise the value. Press the ENTER key to execute the setting. Press the ESC key to return to the previous menu.

## 6.5.7 Special Settings



This functions is applicable by maintenance personnel only, wrong operation will prevent the inverter from working properly.

## 6.5.8 STD. Mode Settings

This sub menu is enabled when the grid standard is set to AS4777. To comply with New AUS/ NZ 4777.2, Solis 4G inverter could set different work mode to work with different grid requirement.

There are 5 setting under STD. Mode settings.

1. Working mode
2. Power Rate limit
3. Freq. Derate set
4. 10mins OV-G-V set.
5. Initial Settings



This functions is applicable by maintenance personnel only, wrong operation will prevent the inverter from working properly.

There are 6 work mode in working mode submenu.

- 1.NULL
- 2.Volt-watt
- 3.Volt-var
- 4.Fixed-PF
- 5.Reac-power
- 6.Power-PF

The parameter in each model could be set as below:

### 1. NULL(default)

Inverter not under any of below working mode.

The default setting of working mode is NULL.

### 2. Volt-Watt

- Set Voltage1: 207-220V, Default 207V
- Set P\_Limit1: 20%-100%, Default 100%
- Set Voltage2: 216-230V, Default 220V
- Set P\_Limit2: 20%-100%, Default 100%
- Set Voltage3: 235-255V, Default 250V
- Set P\_Limit3: 20%-100%, Default 100%
- Set Voltage4: 244-265V, Default 255V
- Set P\_Limit4: 20%-100%, Default 100%

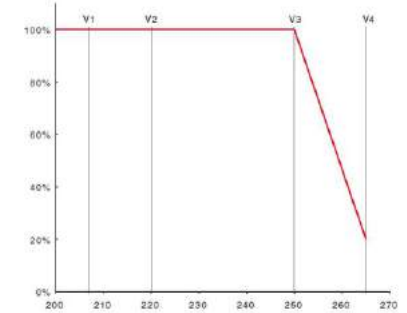

### 3. Volt-Var

- Set Voltage1: 207-220V, Default 207V
- Set Voltage2: 216-230V, Default 220V
- Set Voltage3: 235-255V, Default 250V
- Set Voltage4: 244-265V, Default 255V
- Set Leading: 0~+60%, Default +30%
- Set Lagging: 0~-60%, Default -30%

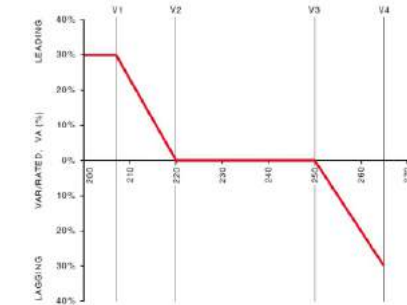

### 4. Fixed PF

Set PF (-0.8, +0.8), Default 1, Resolution 0.01.

### 5. Reac. Power

Set reactive power (0, 60%), Default 0, Resolution 1%.

### 6. Power-PF

- Set Pb\_Limit: 0-100%, Default 25%
- Pc\_Limit: 0-100%, Default 50%
- Pc\_Factor: (-0.8, +0.8), Default -0.95

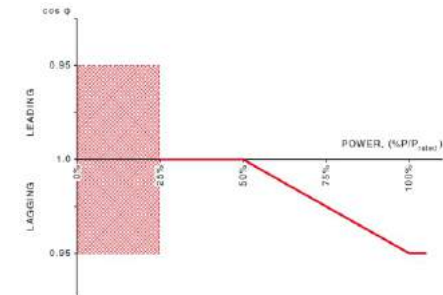

# 6. Operation

# 6. Operation

The other 3 setting in STD. Mode settings are as below:

## 1. Power Rate limit

Wgra: 0-100%, Default 16%

## 2. Freq. Derate set

Set Derate Mode:01

Set Freq.: 51-52Hz, Default 52Hz

## 3. 10mins OV-G-V set

10mins Voltage: 244-255V, Default 248V

## 6.5.9 Restore Settings

Restore setting could set all item in 6.5.7 special setting to default.

The screen shows as below:



Are you sure?  
YES=<ENT> NO=<ESC>

▲ Figure 6.21 Restore Settings

Press the Enter key to save the setting after setting grid off.

Press the ESC key to return the previous mean.

## 6.5.10 HMI Update

This function is used for update the LCD program.



This function is applicable by maintenance personnel only, wrong operation will prevent the inverter from reaching maximum power.

## 6.5.11 Export Power Set



### NOTE:

To access to this area is for fully qualified and accredited technicians only. Please follow 6.4 to enter password to access this menu.

The default password is "0010". Please press "down" to move the cursor, press "up" to select the number.

Select EPM Settings from the Main Menu to access the following options:

1. Model Select
2. Set Backflow Power
3. Fail safe ON/OFF

## 6.5.11.1 Model Select

There are 4 settings in this menu as below:

1. OFF
2. Meter in Load
3. Meter in Grid
4. Current sensor

### 6.5.11.1.1 OFF

This function is used to shut down the Export Power Set.



ON=<ENT> CANCEL=<ESC>  
OFF

▲ Figure 6.22

Press the ENTER key to set done.

Press the ESC key to the previous menu.

### 6.5.11.1.2 Meter in Load

The submenu is used to set meter in Load as shown as 4.3.7 Meter connection(optional).

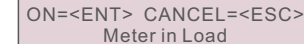

ON=<ENT> CANCEL=<ESC>  
Meter in Load

▲ Figure 6.23

Press Enter key to save the setting.

### 6.5.11.1.3 Meter in Grid

The submenu is used to set meter in Grid as shown as 4.3.7 Meter connection(optional).



ON=<ENT> CANCEL=<ESC>  
Meter in Grid

▲ Figure 6.24

Press Enter key to save the setting.

### 6.5.11.1.4 Current sensor

The submenu is used to set current sensor as shown as 4.3.8 CT connection(optional).

There are 2 modes shown as below: 1. CT Sampling Ratio 2. CT Link test

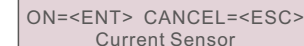

ON=<ENT> CANCEL=<ESC>  
Current Sensor

▲ Figure 6.25

## 6.5.11.1.4.1 CT Sampling Ratio

This function is used for change CT Sampling Ratio if customer select different CT. The default ratio is 3000:1.

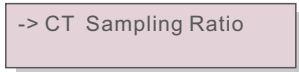

▲ Figure 6.26 Set the CT Para of the EPM

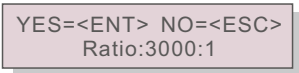

▲ Figure 6.27

Press the UP/DOWN keys to set data. Press the ENTER key to set CT Para. Press the ESC key to save the settings and return to the previous menu.

## 6.5.11.1.4.2 CT Link Test

**Before pressing the CT Link Test menu, please check as follow:**

1. Load power  $\geq$  500W
2. Inverter should be set Grid Off
3. CT should be connected
4. EPM should be set ON

Press the ENTER key to show the screen of CT Link Test. It will show as below when the EPM was set ON:

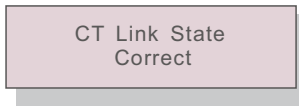

▲ Figure 6.28 CT Link State

Press the ESC key to the previous menu.



**NOTE:**

There are three states in the CT Link State.  
 "Error" means CT reverse connection. Please change CT direction  
 "Can not judge" means load power is not enough, it should be more than 500W.  
 "Correct" means CT has been connected correctly.

## 6.5.11.2 Backflow Power

This submenu is used for set allowed power that inverter can generate to grid.

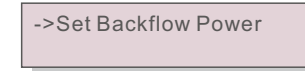

▲ Figure 6.29 Set the backflow power



▲ Figure 6.30

Press the UP/DOWN keys to set data. Press the ENTER key to set backflow power. Then press DOWN keys to move the cursor, press UP to change the number. Press the ESC key to save the settings and return to the previous menu.

## 6.5.11.3 Fail safe ON/OFF

This function is used to remind whether the EPM is ON or not. The default setting is ON.



▲ Figure 6.31 Set the Fail Safe ON/OFF

Press the UP/DOWN keys to set ON/OFF. Press the ENTER key to set done. Press the ESC key to the previous menu.

# 6. Operation

## 6.5.12 Restart HMI

The function is used for restart the HMI.



This function is applicable by maintenance personnel only, wrong operation will prevent the inverter from reaching maximum power.

## 6.5.13 Debug Parameter

This function is used for manufacturer maintenance personnel only.

## 6.5.14 DSP Update

The function is used for update the DSP.



This function is applicable by maintenance personnel only, wrong operation will prevent the inverter from reaching maximum power.

## 6.5.15 Power Parameter

This function is used for calibrate inverter output energy. It will not impact the energy count for inverter with RGM.

The screen shows:



▲ Figure 6.32 Power Rate Limit

Press the Down key to move the cursor.

Press the Up key to change the digit.

Please press the Enter to save the setting and press the ESC key to return to the previous menu.



This setting is used for grid operator, don't change setting under this manual.

# 7. Maintenance

## 7. Maintenance

Solis Mini Single Phase 4G Inverter does not require any regular maintenance. However, cleaning the dust on heat-sink will help the inverter to dissipate the heat and increase its life time. The dust can be removed with a soft brush.



**CAUTION:**

Do not touch the inverter's surface when it is operating. Some parts of the inverter may be hot and cause burns. Turn off the inverter (refer to Section 5.2) and wait for a cool-down period before before any maintenance or cleaning operation.

The LCD and the LED status indicator lights can be cleaned with a damp cloth if they are too dirty to be read.



**NOTE:**

Never use any solvents, abrasives or corrosive materials to clean the inverter.

# 8. Troubleshooting

The inverter is designed in accordance with the most important international grid-tied standards and safety and electromagnetic compatibility requirements. Before delivering to the customer, the inverter has been subjected to several tests to ensure its optimal operation and reliability.

In case of failure, the LCD screen will display an alarm message. In this case, the inverter may stop feeding into the grid. The failure descriptions and their corresponding alarm messages are listed in Table 8.1:

# 8. Trouble Shooting

# 8. Trouble Shooting

Alarm Message	Failure description	Solution
No power	Inverter no power on LCD	1.Check PV input connections 2.Check DC input voltage (single phase >120V, three phase >350V) 3.Check if PV+/- is reversed
LCD show initializing all the time	can not start-up	1.Check if the connector on main board or power board are fixed. 2.Check if the DSP connector to power board are fixed.
OV-G-V01/02/03/04	Over grid voltage	1.Resistant of AC cable is too high. Change bigger size grid cable 2.Adjust the protection limit if it's allowed by electrical company.
UN-G-V01/02	Under grid voltage	1. Use user define function to adjust the protection limit if it's allowed by electrical company.
OV-G-F01/02	Over grid frequency	
UN-G-F01/02	Under grid frequency	
G-IMP	High grid impedance	
NO-GRID	No grid voltage	1.Check connections and grid switch. 2.Check the grid voltage inside inverter terminal.
OV-DC01/02/03/04	Over DC voltage	1.Reduce the module number in series
OV-BUS	Over DC bus voltage	1.Check inverter inductor connection 2.Check driver connection
UN-BUS01/02	Under DC bus voltage	
GRID-INTF01/02	Grid interference	1.Restart inverter 2.Change power board
OV-G-I	Over grid current	
IGBT-OV-I	Over IGBT current	
DC-INTF OV-DCA-I	DC input overcurrent	1.Restart inverter 2.Identify and remove the string to the fault MPPT 2.Change power board
IGFOL-F	Grid current tracking fail	1.Restart inverter or contact installer.
IG-AD	Grid current sampling fail	
OV-TEM	Over Temperature	1.Check inverter surrounding ventilation. 2.Check if there's sunshine direct on inverter in hot weather.
INI-FAULT	Initialization system fault	1.Restart inverter or contact installer.
DSP-B-FAULT	Comm. failure between main and slave DSP	
12Power-FAULT	12V power supply fault	
PV ISO-PRO 01/02	PV isolation protection	1.Remove all DC input, reconnect and restart inverter one by one. 2.Identify which string cause the fault and check the isolation of the string.

Alarm Message	Failure description	Solution
ILeak-PRO 01/02/03/04	Leakage current protection	1.Check AC and DC connection 2.Check inverter inside cable connection.
RelayChk-FAIL	Relay check fail	1.Restart inverter or contact installer.
DCinj-FAULT	High DC injection current	1.Restart inverter or contact installer.

▲ Table 8.1 Fault message and description



**NOTE:**

If the inverter displays any alarm message as listed in Table 8.1; please turn off the inverter (refer to Section 5.2 to stop your inverter) and wait for 5 minutes before restarting it (refer to Section 5.1 to start your inverter). If the failure persists, please contact your local distributor or the service center. Please keep ready with you the following information before contacting us.

1. Serial number of Solis Single Phase Inverter;
2. The distributor/dealer of Solis Single Phase Inverter (if available);
3. Installation date.
4. The description of problem (i.e. the alarm message displayed on the LCD and the status of the LED status indicator lights. Other readings obtained from the Information submenu (refer to Section 6.2) will also be helpful.);
5. The PV array configuration (e.g. number of panels, capacity of panels, number of strings , etc.);
6. Your contact details.

# 9. Specifications

Model	Solis-mini-700-4G
Max. DC input power (Watts)	900
Max. DC input voltage (Volts)	600
Rated DC voltage (Volts)	200
Start-up voltage (Volts)	60
MPPT voltage range (Volts)	50...550
Max. input current (Amps)	11
Max short circuit input current (Amps)	17.2
MPPT number/Max input strings number	1/1
Rated output power (Watts)	700
Max. output power (Watts)	800
Max. apparent output power (VA)	800
Rated grid voltage (Volts)	220/230
Rated output current (Amps)	3.2/3.0
Power Factor (at rated output power)	0.8leading~0.8lagging
THDi (at rated output power)	<1.5%
Rated grid frequency (Hertz)	50/60
Operating frequency range (Hertz)	47...52 or 57...62
Max. efficiency	97.2%
EU efficiency	96.5%
MPPT efficiency	>99.5%
Dimensions	310W*373H*160D (mm)
Weight	7.4kg
Topology	Transformerless
Operating ambient temperature range	-25°C. . . 60°C
Ingress protection	IP65
Noise emission (typical)	<20 dBA
Cooling concept	Natural convection
Max.operation altitude	4000m
Designed lifetime	>20 years
Grid connection standard	EN50438, G83/2, AS4777.2:2015, VDE0126-1-1, IEC61727, VDE N4105
Operating surroundings humidity	0...100% Condensing
Connention	Mc4 connector and Ip67 rated plug
Display	LCD, 2×20 Z.
Communication connections	4 pins RS485 connector
Monitoring	WiFi or GPRS
Warranty Terms	5 Years STD (Extendable to 20 Years)

# 9. Specifications

Model	Solis-mini-1000-4G
Max. DC input power (Watts)	1200
Max. DC input voltage (Volts)	600
Rated DC voltage (Volts)	200
Start-up voltage (Volts)	60
MPPT voltage range (Volts)	50...550
Max. input current (Amps)	11
Max short circuit input current (Amps)	17.2
MPPT number/Max input strings number	1/1
Rated output power (Watts)	1000
Max. output power (Watts)	1100
Max. apparent output power (VA)	1100
Rated grid voltage (Volts)	220/230
Rated output current (Amps)	4.5/4.3
Power Factor (at rated output power)	0.8leading~0.8lagging
THDi (at rated output power)	<1.5%
Rated grid frequency (Hertz)	50/60
Operating frequency range (Hertz)	47...52 or 57...62
Max. efficiency	97.2%
EU efficiency	96.5%
MPPT efficiency	>99.5%
Dimensions	310W*373H*160D (mm)
Weight	7.4kg
Topology	Transformerless
Operating ambient temperature range	-25°C. . . 60°C
Ingress protection	IP65
Noise emission (typical)	<20 dBA
Cooling concept	Natural convection
Max.operation altitude	4000m
Designed lifetime	>20 years
Grid connection standard	EN50438, G83/2, AS4777.2:2015, VDE0126-1-1, IEC61727, VDE N4105
Operating surroundings humidity	0...100% Condensing
Connention	Mc4 connector and Ip67 rated plug
Display	LCD, 2×20 Z.
Communication connections	4 pins RS485 connector
Monitoring	WiFi or GPRS
Warranty Terms	5 Years STD (Extendable to 20 Years)

## 9. Specifications

Model	Solis-mini-1500-4G
Max. DC input power (Watts)	1800
Max. DC input voltage (Volts)	600
Rated DC voltage (Volts)	200
Start-up voltage (Volts)	60
MPPT voltage range (Volts)	50...550
Max. input current (Amps)	11
Max short circuit input current (Amps)	17.2
MPPT number/Max input strings number	1/1
Rated output power (Watts)	1500
Max. output power (Watts)	1700
Max. apparent output power (VA)	1700
Rated grid voltage (Volts)	220/230
Rated output current (Amps)	6.8/6.5
Power Factor (at rated output power)	0.8leading~0.8lagging
THDi (at rated output power)	<1.5%
Rated grid frequency (Hertz)	50/60
Operating frequency range (Hertz)	47...52 or 57...62
Max. efficiency	97.2%
EU efficiency	96.5%
MPPT efficiency	>99.5%
Dimensions	310W*373H*160D (mm)
Weight	7.4kg
Topology	Transformerless
Operating ambient temperature range	-25°C. . . 60°C
Ingress protection	IP65
Noise emission (typical)	<20 dBA
Cooling concept	Natural convection
Max. operation altitude	4000m
Designed lifetime	>20 years
Grid connection standard	EN50438, G83/2, AS4777.2:2015, VDE0126-1-1, IEC61727, VDE N4105
Operating surroundings humidity	0...100% Condensing
Connention	Mc4 connector and Ip67 rated plug
Display	LCD, 2×20 Z.
Communication connections	4 pins RS485 connector
Monitoring	WiFi or GPRS
Warranty Terms	5 Years STD (Extendable to 20 Years)

## 9. Specifications

Model	Solis-mini-2000-4G
Max. DC input power (Watts)	2300
Max. DC input voltage (Volts)	600
Rated DC voltage (Volts)	330
Start-up voltage (Volts)	90
MPPT voltage range (Volts)	80...550
Max. input current (Amps)	11
Max short circuit input current (Amps)	17.2
MPPT number/Max input strings number	1/1
Rated output power (Watts)	2000
Max. output power (Watts)	2200
Max. apparent output power (VA)	2200
Rated grid voltage (Volts)	220/230
Rated output current (Amps)	9.1/8.7
Power Factor (at rated output power)	0.8leading~0.8lagging
THDi (at rated output power)	<1.5%
Rated grid frequency (Hertz)	50/60
Operating frequency range (Hertz)	47...52 or 57...62
Max. efficiency	97.2%
EU efficiency	96.5%
MPPT efficiency	>99.5%
Dimensions	310W*373H*160D (mm)
Weight	7.4kg
Topology	Transformerless
Operating ambient temperature range	-25°C. . . 60°C
Ingress protection	IP65
Noise emission (typical)	<20 dBA
Cooling concept	Natural convection
Max. operation altitude	4000m
Designed lifetime	>20 years
Grid connection standard	EN50438, G83/2, AS4777.2:2015, VDE0126-1-1, IEC61727, VDE N4105
Operating surroundings humidity	0...100% Condensing
Connention	Mc4 connector and Ip67 rated plug
Display	LCD, 2×20 Z.
Communication connections	4 pins RS485 connector
Monitoring	WiFi or GPRS
Warranty Terms	5 Years STD (Extendable to 20 Years)



## 9. Specifications

Model	Solis-mini-2500-4G
Max. DC input power (Watts)	3000
Max. DC input voltage (Volts)	600
Rated DC voltage (Volts)	330
Start-up voltage (Volts)	90
MPPT voltage range (Volts)	80...550
Max. input current (Amps)	11
Max short circuit input current (Amps)	17.2
MPPT number/Max input strings number	1/1
Rated output power (Watts)	2500
Max. output power (Watts)	2800
Max. apparent output power (VA)	2800
Rated grid voltage (Volts)	220/230
Rated output current (Amps)	11.4/10.9
Power Factor (at rated output power)	0.8leading~0.8lagging
THDi (at rated output power)	<1.5%
Rated grid frequency (Hertz)	50/60
Operating frequency range (Hertz)	47...52 or 57...62
Max. efficiency	97.5%
EU efficiency	96.8%
MPPT efficiency	>99.5%
Dimensions	310W*373H*160D (mm)
Weight	7.7kg
Topology	Transformerless
Operating ambient temperature range	-25°C. . . 60°C
Ingress protection	IP65
Noise emission (typical)	<20 dBA
Cooling concept	Natural convection
Max.operation altitude	4000m
Designed lifetime	>20 years
Grid connection standard	EN50438, G83/2, AS4777.2:2015, VDE0126-1-1, IEC61727, VDE N4105
Operating surroundings humidity	0...100% Condensing
Connention	Mc4 connector and Ip67 rated plug
Display	LCD, 2×20 Z.
Communication connections	4 pins RS485 connector
Monitoring	WiFi or GPRS
Warranty Terms	5 Years STD (Extendable to 20 Years)

## 9. Specifications

Model	Solis-mini-3000-4G
Max. DC input power (Watts)	3500
Max. DC input voltage (Volts)	600
Rated DC voltage (Volts)	330
Start-up voltage (Volts)	90
MPPT voltage range (Volts)	80...550
Max. input current (Amps)	11
Max short circuit input current (Amps)	17.2
MPPT number/Max input strings number	1/1
Rated output power (Watts)	3000
Max. output power (Watts)	3300
Max. apparent output power (VA)	3300
Rated grid voltage (Volts)	220/230
Rated output current (Amps)	13.6/13
Power Factor (at rated output power)	0.8leading~0.8lagging
THDi (at rated output power)	<1.5%
Rated grid frequency (Hertz)	50/60
Operating frequency range (Hertz)	47...52 or 57...62
Max. efficiency	97.5%
EU efficiency	96.8%
MPPT efficiency	>99.5%
Dimensions	310W*373H*160D (mm)
Weight	7.7kg
Topology	Transformerless
Operating ambient temperature range	-25°C. . . 60°C
Ingress protection	IP65
Noise emission (typical)	<20 dBA
Cooling concept	Natural convection
Max.operation altitude	4000m
Designed lifetime	>20 years
Grid connection standard	EN50438, G83/2, AS4777.2:2015, VDE0126-1-1, IEC61727, VDE N4105
Operating surroundings humidity	0...100% Condensing
Connention	Mc4 connector and Ip67 rated plug
Display	LCD, 2×20 Z.
Communication connections	4 pins RS485 connector
Monitoring	WiFi or GPRS
Warranty Terms	5 Years STD (Extendable to 20 Years)

## 9. Specifications

Model	Solis-mini-3600-4G
Max. DC input power (Watts)	4000
Max. DC input voltage (Volts)	600
Rated DC voltage (Volts)	330
Start-up voltage (Volts)	90
MPPT voltage range (Volts)	80...550
Max. input current (Amps)	11
Max short circuit input current (Amps)	17.2
MPPT number/Max input strings number	1/2
Rated output power (Watts)	3600
Max. output power (Watts)	3600
Max. apparent output power (VA)	3600
Rated grid voltage (Volts)	220/230
Rated output current (Amps)	16
Power Factor (at rated output power)	0.8leading~0.8lagging
THDi (at rated output power)	<1.5%
Rated grid frequency (Hertz)	50/60
Operating frequency range (Hertz)	47...52 or 57...62
Max. efficiency	97.5%
EU efficiency	96.8%
MPPT efficiency	>99.5%
Dimensions	310W*373H*160D (mm)
Weight	7.7kg
Topology	Transformerless
Operating ambient temperature range	-25°C. . . 60°C
Ingress protection	IP65
Noise emission (typical)	<20 dBA
Cooling concept	Natural convection
Max. operation altitude	4000m
Designed lifetime	>20 years
Grid connection standard	EN50438, G83/2, AS4777.2:2015, VDE0126-1-1, IEC61727, VDE N4105
Operating surroundings humidity	0...100% Condensing
Connention	Mc4 connector and Ip67 rated plug
Display	LCD, 2x20 Z.
Communication connections	4 pins RS485 connector
Monitoring	WiFi or GPRS
Warranty Terms	5 Years STD (Extendable to 20 Years)

## 9. Specifications

Model	Solis-mini-1000-4G-LV
Max. DC input power (Watts)	1200
Max. DC input voltage (Volts)	600
Rated DC voltage (Volts)	200
Start-up voltage (Volts)	90
MPPT voltage range (Volts)	50...500
Max. input current (Amps)	11
Max short circuit input current (Amps)	17.2
MPPT number/Max input strings number	1/1
Rated output power (Watts)	1000
Max. output power (Watts)	1100
Max. apparent output power (VA)	1100
Rated grid voltage (Volts)	101/120/127
Rated output current (Amps)	8.3
Power Factor (at rated output power)	0.8leading~0.8lagging
THDi (at rated output power)	<1.5%
Rated grid frequency (Hertz)	50/60
Operating frequency range (Hertz)	47...52 or 57...62
Max. efficiency	97.2%
EU efficiency	96.5%
MPPT efficiency	>99.5%
Dimensions	310W*373H*160D (mm)
Weight	7.4kg
Topology	Transformerless
Operating ambient temperature range	-25°C. . . 60°C
Ingress protection	IP65
Noise emission (typical)	<20 dBA
Cooling concept	Natural convection
Max. operation altitude	4000m
Designed lifetime	>20 years
Grid connection standard	EN50438, G83/2, AS4777.2:2015, VDE0126-1-1, IEC61727, VDE N4105
Operating surroundings humidity	0...100% Condensing
Connention	Mc4 connector and Ip67 rated plug
Display	LCD, 2x20 Z.
Communication connections	4 pins RS485 connector
Monitoring	WiFi or GPRS
Warranty Terms	5 Years STD (Extendable to 20 Years)



No. 57 Jintong Road,  
Binhai (Sea front) Industrial Park,  
Xiangshan, Ningbo, Zhejiang, 315712, P.R.China  
Tel: (+86) 574 6578 1806 Fax: (+86) 574 6578 1606  
E-Mail: info@Ginlong.com

## Installation environment caution

Ginlong Solis installation parameters:

Note: Product specifications are subject to change without notice. Every attempt has been made to make this document complete, accurate and up-to-date. Individuals reviewing this document and installers or service personnel are cautioned, however, that Ginlong Technologies reserves the right to make changes without notice and shall not be responsible for any damages, including indirect, incidental or consequential damages caused by reliance on the material presented including, but not limited to, omissions, typographical errors, arithmetical errors or listing errors in the material provided in this document.

Ginlong Technologies accepts no liability for customers' failure to comply with the instructions for correct installation and will not be held responsible for upstream or downstream systems Ginlong's equipment has supplied.

The customer is fully liable for any modifications made to the system; therefore, any hardware or software modification, manipulation, or alteration not expressly agreed with the manufacturer shall result in the immediate cancellation of the warranty.

Given the countless possible system configurations and installation environments, it is essential to verify adherence to the following:

Installation environment caution:

- Refer to the local regulatory requirements, Australian Standards, and CEC guidelines
- Consult the Ginlong Solis technical data when considering the environmental elements such as sun exposure, heat, light, rain, noise and airflow
- Inverter installations in locations where there is unprotected exposure to direct sunlight must be avoided (or the warranty will be voided) as this may cause:-
  1. Compromise of the operational life and function of the electrical / electromechanical components
  2. Damage to the mechanical sealing components (gaskets), identification labels and markings or the LCD display
  3. Compromise of the optimum productivity and operation delivering decreased energy production from the system
  4. Do not install in small rooms, cupboards, or confined spaces where airflow is restricted or limited
  5. To avoid potential for over heating always ensure airflow around the inverter is unrestricted
  6. Do not install above any heat source such as heating, air-conditioning, water heating equipment etc.
  7. never install inverter equipment on unprotected and exposed north or west facing walls
  8. Do not install directly onto flammable wall surfaces such as wooden cladding (e.g. use cement sheet barrier)
  9. Do not install in rooms or on walls directly abutting those used for prolonged periods by people (e.g. bedroom walls)

Note: This product contains lethal voltages and should only be installed by qualified and appropriately accredited electrical or service personnel having experience with lethal voltages.

Ginlong Technologies will not be held liable for defects or malfunctions arising from:

- Improper use of the equipment,
- Performing maintenance incorrectly or not at all.
- Tampering or unsafe repairs.
- Use or installation by unqualified persons directly abutting those used for prolonged periods by people (e.g. bedroom walls)