

PV Grid Tie Inverter

Solis Three Phase Inverter

For model Solis-20K, Solis-25K, Solis-30K, Solis-30K-HE
Solis-36K-HV, Solis-40K-HV

Installation and Operation Manual



Ningbo Ginlong Technologies Co., Ltd.

No. 57 Jintong Road, Binhai Industrial Park, Xiangshan, Ningbo,
Zhejiang, 315712, P.R.China.

Tel: +86 (0)574 6578 1806

Fax: +86 (0)574 6578 1606

Email: info@ginlong.com

Web: www.ginlong.com

If you encounter any problem on the inverter, please find out the inverter S/N
and contact us, we will try to respond to your question ASAP.



© 2014, Ningbo Ginlong Technologies Co., Ltd

Content

1. Introduction	3
1.1 Induction	4
1.2 Packaging List	4
2. Safety Instruction	5
2.1 Safety Symbols	5
2.2 General Safety Instruction	5
2.3 Notice For Use	6
3. Overview	7
3.1 Inverter Interface Instructions	7
3.2 LED Status Indicator Light	7
3.3 Keypad	8
3.4 LCD	8
4. Product handing and storage	9
4.1 Product handing	9
4.2 Product storage	10
5. Installation	11
5.1 Select a Location for the Inverter	11
5.2 Mounting the Inverter	13
5.3 Electrical Connections	15
5.3.1 DC side connection	16
5.3.2 AC side connection	18
5.3.3 Inverter monitoring connection	20
6. Start and Stop	23
6.1 Start the Inverter	23
6.2 Stop the Inverter	23
7. General Operation	24
7.1 Interface	24

Content

7.1.1 Main Menu	25
7.2 Information	26
7.3 Setting	27
7.3.1 Setting Time	27
7.3.2 Setting Address	28
7.3.3 Language Setting	28
7.3.4 Screen Brightness Control	29
7.3.5 System Update	30
7.4 Advanced Info - Technicians Only	30
7.4.1 Alarm Message	31
7.4.2 Operational Message	32
7.4.3 Version NO.	32
7.4.4 Communication Data	33
7.4.5 Daily Energy Information	33
7.4.6 Monthly Energy Detail	34
7.4.7 Yearly Energy Detail	34
7.4.8 Total Energy Detail	35
7.4.9 Work Log	35
7.5 Advanced Settings - Technicians Only	36
7.5.1 Select Grid Standard	36
7.5.2 Grid ON/OFF	39
7.5.3 Power Setting	39
7.5.4 Clear Energy and Restore factory settings	40
7.5.5 Calibrate Energy	40
7.5.6 Change Password	41
8. Maintenance	42
9. Trouble Shooting	42
10. Specification	44

1. Introduction

Solis three phase series PV inverters is able to transfer DC power from PV panels into AC power and feed into grid.

There are 6 models for Solis three phase inverter:

Solis-20K Solis-25K Solis-30K Solis-30K-HE

Solis-36K-HV Solis-40K-HV(HV refer to 480V rated grid voltage)



▲ Figure 1.1 Front view



▲ Figure 1.2 Bottom view

1. Introduction

2. Safety Instruction

1.2 Packaging List

Please check according to following table, to see whether all the parts were included in the packaging:



Part NO.	Description	Number
1	PV grid tie Inverter	1
2	Wall mounting bracket	1
3	Locking screws	2
4	Expansion screws	3
5	Rj45 connector	2 set
6	DC connectors	8 pairs
7	Adhesive tape	1
8	Manual	1

▲ Table 1.1 Material list

Improper use may result in potential electric shock hazards or burns. This manual contains important instructions that should be followed during installation and maintenance. Please read these instructions carefully before use and keep them for future reference.

2.1 Safety Symbols

Safety symbols used in this manual, which highlight potential safety risks and important safety information, are listed as follows:



WARNING:

WARNING symbol indicates important safety instructions, which if not correctly followed, could result in serious injury or death.



NOTE:

NOTE symbol indicates important safety instructions, which if not correctly followed could result in some damage or the destruction of the inverter.



CAUTION :

CAUTION, RISK OF ELECTRIC SHOCK symbol indicates important safety instructions, which if not correctly followed, could result in electric shock.



CAUTION:

CAUTION, HOT SURFACE symbol indicates safety instructions, which if not correctly followed, could result in burns.

2.2 General Safety Instructions



WARNING:

DC input and AC output must be electrically isolated before operation. DO NOT connect PV array positive (+) or negative (-) to the ground. To do so may cause serious damage to the inverter.



WARNING:

Electrical installations must be done in accordance with the local and national regulatory and electrical safety standards.

2. Safety Instruction

WARNING:



To reduce the risk of fire, over-current protective devices (OCPD) are required for circuits connected to the Inverter. The recommended rated trip current of OCPD, Solis-20K should be 40A, Solis-25K, Solis-30K, Solis-30K-HE, Solis-36K-HV and Solis-40K-HV should be 63A.



CAUTION:

Risk of electric shock. Do not remove cover. Refer maintenance servicing to qualified and accredited service technician.



CAUTION:

The PV array (Solar panels) supplies a DC voltage when it is exposed to light.



CAUTION:

Risk of electric shock from energy stored in capacitors of the Inverter. Do not remove cover until 5 minutes after disconnecting all sources of supply. Service technician only. Warranty may be voided if any unauthorized removal of cover.



CAUTION:

The surface temperature of the inverter can exceed 75°C (167F). To avoid risk of burns, DO NOT touch the surface when inverter is operating. The inverter must be installed out of reach of children.

2.3 Notice For Use

The inverter was designed in accordance with relevant safety regulation to meet end user's demand. The usage of inverter and installation should meet the following requirement:

1. Secure inverter installation is required.
2. The inverter must be connected to a separate grounded AC group, to which no other electrical equipment is connected
3. The electrical installation must meet all the applicable regulations and standards.
4. The inverter must be installed according to the instructions stated in this manual.

3. Overview

5. The inverter must be installed according to the correct technical specifications.
6. To startup the inverter, the Grid Supply Main Switch (AC) must be switched on, before the solar panel's DC isolator switched on. To stop the inverter, the Grid Supply Main Switch (AC) must be switched off before the solar panel's DC isolator switched off.
7. DC input voltage of inverter must less than its maximum input voltage of inverter.

3.1 Inverter Interface Instructions



▲ Figure 3.1 Front Panel Display

3.2 LED Status Indicator Lights

There are three LED status indicator lights in the front panel of the inverter.

In the Left: POWER LED indicates the power status of the inverter.

In the Middle: OPERATION LED (green) indicates the operation status.

In the Right: ALARM LED (yellow) indicates the alarm status.

Please see Table 3.1 for details

3. Overview

Light	Status	Description
● POWER	ON	The inverter can detect DC power
	OFF	No DC power or low DC power
● OPERATION	ON	The inverter is operating properly.
	OFF	The inverter has stopped supplying power.
	FLASHING	The inverter is initializing.
● ALARM	ON	Alarm or fault condition is detected.
	OFF	The inverter is operating properly.

▲ Table 3.1 Status indicator

3.3 Keypad

There are four keys in the front panel of the Inverter(from left to right): ESC, UP, DOWN and ENTER keys. The keypad is used for:

- Scrolling through the displayed options (the Up and the Down keys).
- Access to modify the adjustable settings (the ESC and the ENTER keys).

3.4 LCD

The two-lines Liquid Crystal Display (LCD) is located at the front panel of the Inverter, which shows the following information:

- 1.Inverter operation status and data;
- 2.Service messages for operator;
- 3.Alarm messages and fault indications.

4. Product handing and storage

4.1 Product handing

Please refer below to handing the product:

1.The red mark is used for handle the product with package. The product need two persons to carry. (as shown in figure 4.1)



▲ Figure 4.1 move the inverter

2.After open the package, it's recommend two person to get the inverter out of package. Please handle the side of heat-sink when carry the inverter.(as shown in figure 4.2)

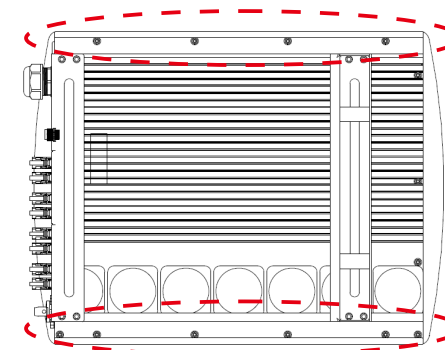

▲ Figure 4.2 carry out the inverter

4. Installation

4.2 Product storage

If the inverter is not for using at present, it should be stored under the specific environment:

- Please use the original box to repackage the inverter, and retain the desiccant.
- Packing boxes should be sealed with adhesive tape.
- Please store the inverter in a clean and dry place, and keep it without the erosion of dust and vapor.
- Storage temperature should be kept at -25°C - 60°C , and the relative humidity should be kept between 0 to 95%.And kept no condensation.
- The maximum cumulative number of layers should not be more than 4 when stack of multiple inverters.
- Please avoid the chemical corrosive substances,because it maybe corrod the inverter.
- The regular inspection is needed during the storage. If found the rat bite etc.,should replace the packing material in time
- The packing box should not be inclined or upside down.
- After long-term storage, the inverter needs to be fully examined and tested by professional person before using.

5. Installation

5.1 Select a Location for the Inverter

To select a location for the inverter the following criteria should be considered:

- Do not install the inverter in unventilated confined space. To avoid poor performance or damage inverter, air flow is needed.
- Exposure to direct sunlight will increase the operational temperature of the inverter and may cause output power limiting. Ginlong recommend inverter installed to avoid direct sunlight or raining.
- Shaded or sheltered positions are recommended for maximum performance and service life.



▲ Figure 5.1 Recommended installation position

5. Installation

- A sun shade is recommended to minimise direct sun exposure where ambient temperature may exceed 40°C.
- Install on a vertical surface or structure capable of bearing the weight.
- Must install vertically within +/- 5. If the inverter is tilted from the vertical plane heat dissipation can be inhibited. This may reduce system performance or reduce service life of the inverter.

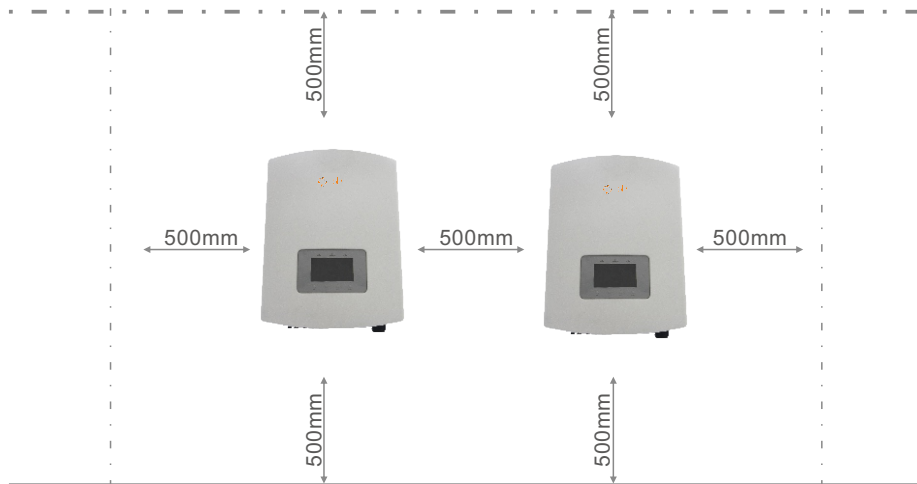

▲ Figure 5.2 Inverter mounting clearance

- A minimum of 500mm clearance is required top, bottom, left and right of the inverter (isolator enclosures excepted) for air flow and cooling.
- Visibility of the LED status indicator lights and LCD display screen should be considered.



NOTE:

The inverter must be installed out of reach of children.

5. Installation

5.2 Mounting the Inverter

The inverter can be mounted to the wall or metal strut of module. The mounting holes should be consistent with the size of the bracket or the dimensions shows below.

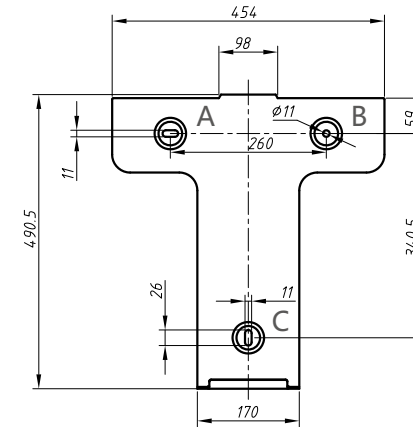

▲ Figure 5.3 The dimensions of the mounting bracket

The inverter should be mounted in a vertical position. The steps of mounting are as follows:

1. According to the figure 5.2, select the mounting height of the bracket and mark the mounting holes. For brick walls, the position of the holes should be suitable for the expansion bolts.
2. MAKE SURE the bracket is horizontal and the mounting holes A, B, and C (in Figure 5.3) are in the correct points. Drilling the holes on the wall according the marks.
3. Using the expansion bolts to fix the bracket to the wall.



WARNING:

The inverter must be mounted vertically on a vertical wall.

5. Installation

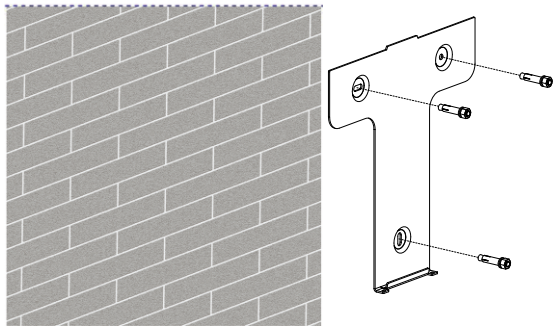

▲ Figure 5.4 Fix the bracket to the wall

4. Lift up the inverter, and make the holes on the back bracket of inverter align to the convex on the mounting bracket. Then fix the inverter to the bracket slowly until it mounts well (in figure 5.5).

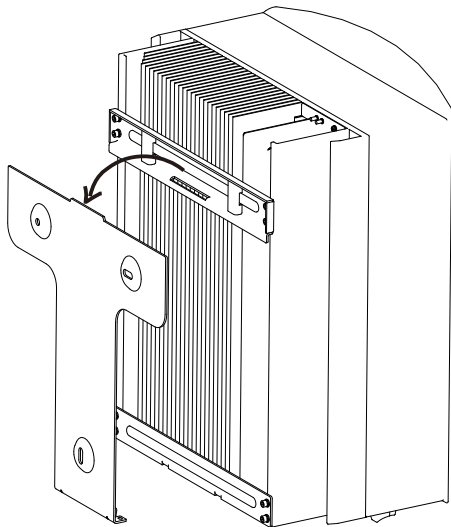

▲ Figure 5.5 Fix the inverter to the bracket

5. Installation

5. Use M4*9 screws to fix the bottom of the inverter to the mount bracket.

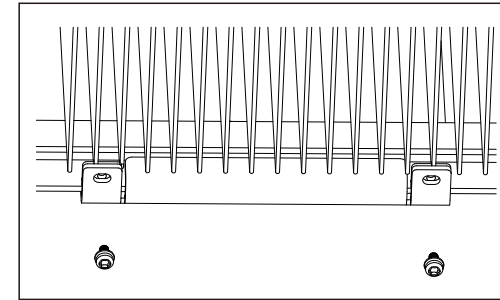

▲ Figure 5.6 Fix the inverter

5.3 Electrical Connections

The Inverter is designed with quick-connect terminal port for electrical connection without removing the cover. The meanings of the symbols at the bottom of the inverter are listed in Table 5.1. All electrical installations must be in accordance with all local and national standards.

+	Positive DC input terminal
-	Negative DC input terminal
DC 1- DC4	DC 1 input terminal
DC SWITCH	Switch of DC input terminals (optional)
COM1	Communication port for Wi-Fi or GPRS stick
COM2, COM3	Communication port of RJ45
GRID	Connecting terminal of the Grid

▲ Table 5.1 Electrical connection symbols

The electrical connection of the inverter must follow the steps listed below:

1. Switch the Grid Supply Main Switch (AC) OFF. Switch the DC Switch OFF.
2. Connect the inverter to PV array.
3. Connect the inverter to the grid.

5. Installation

5. Installation

5.3.1 DC side connection

A) Please make sure the polarity of the output voltage of PV array matches the “DC+” and “DC-” symbols.

B) Connect the “DC+” and “DC-” to the input terminals; see Figure 5.7 and Figure 5.8.



▲ Figure 5.7 DC+ Connector



▲ Figure 5.8 DC- Connector

The steps of assembling the DC connectors are listed as follows:

i) Strip off the DC wire for about 7mm, Disassemble the connector cap nut (see Figure 5.9).



▲ Figure 5.9 Disassemble the Connector Cap nut

ii) Insert the wire into the connector cap nut and contact pin as shown in Figure 4.12.

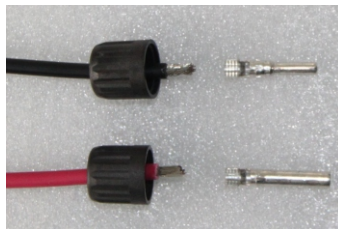

▲ Figure 5.10 Insert the Wire into the Connector Cap nut and contact pin

iii) Crimp the contact pin to the wire using a proper wire crimper as shown in Figure 5.11.

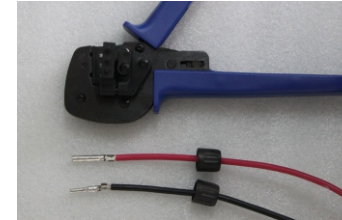

▲ Figure 5.11 Crimp the contact pin to the wire

iv) Insert the contact pin to the top part of the connector and screw up the cap nut to the top part of the connector (as shown in Figure 5.12).

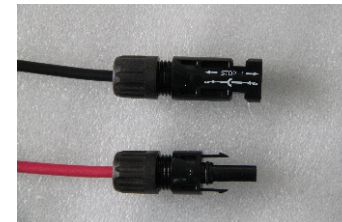

▲ Figure 5.12 Connector with Cap nut Screwed on

v) Then connect the DC connectors to the inverter. Small click will confirm connection (as shown in Figure 5.13).

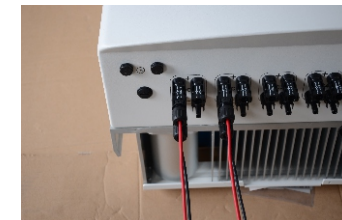

▲ Figure 5.13 Connect the DC Connectors to the Inverter

5. Installation

5. Installation

5.3.2 AC side connection

For all AC connections, 10- 35mm² 105 °C cable is required to be used.

Please make sure the resistance of cable is lower than 1.5 ohm. If the wire is longer than 100m, it's recommended to use 16-35mm² cable.

The steps to assemble the AC grid terminals are listed as follows:

A) Strip the end of AC cable outer insulating jacket about 90mm then strip the end of each wire about 15mm. (as shown in figure 5.14)

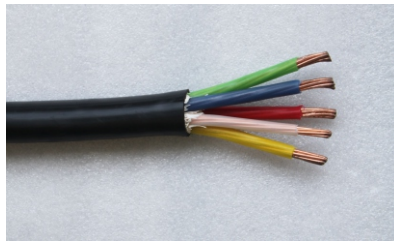

▲ Figure 5.14 Strip AC cable



Additional explanation:

If the diameter of the protective layer of the AC cable is less than the recommended (20K models: 17-25mm;30K models: 21-30mm) it should be spirally wounded the protective.

The adhesive tape is provided in the accessories.

Winding AC cable in a spiral form.

In accordance with the actual outer diameter of the protective layer to decide to wrap one or two layer sealant on the AC cables

AC cable diameter 20K model	AC cable diameter 30K model	layer	The length after winding
10mm~12.9mm	14mm~16.9mm	6	80mm~100mm
13mm~15.9mm	17mm~19.9mm	4	80mm~100mm
16mm~16.9mm	20mm~20.9mm	2	80mm~100mm

Please adhesive tape it on the protective layer of AC cables spirally(as shown in figure 5.15).

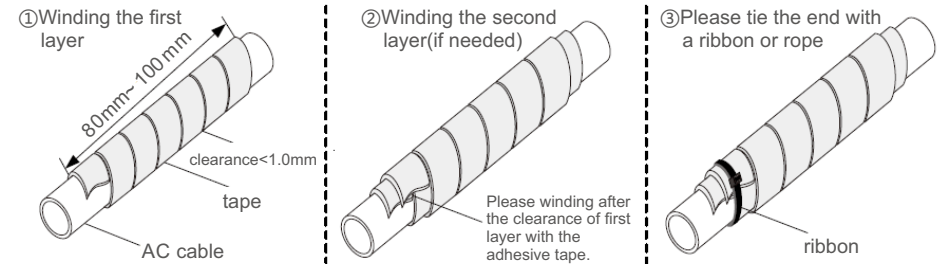

▲ Figure 5.15 Winding AC cable in a spiral form

*This picture only supplies the reference, please take the actual product as the standard

If the wire is over 10mm², the L1 and PE can be 5mm shorter than the L2, L3, and N. In this way the L1 and PE can be easier connected to the connector.

B) Disassemble the 4 screws on the AC terminal cover and take out the cover. Disassemble the screw under terminal rack and Pull out the terminal. (as shown in figure 5.16)

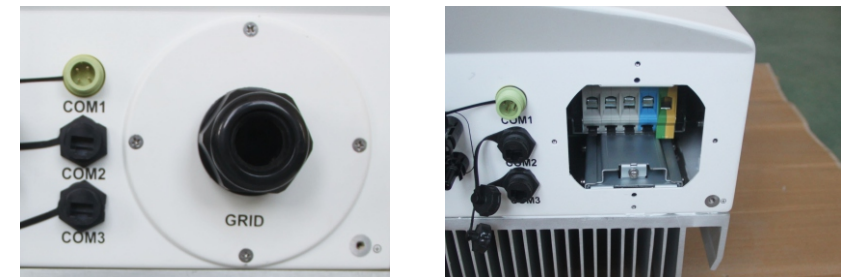

▲ Figure 5.16 Disassemble AC terminal cover

C) Insert the cable through cup nut, water proof sleeve and AC terminal cover into the AC terminal and use a M6 hexagon screwdriver to tight the screws. The torque is 10Nm. (as shown in figure 5.17)

5. Installation

5. Installation

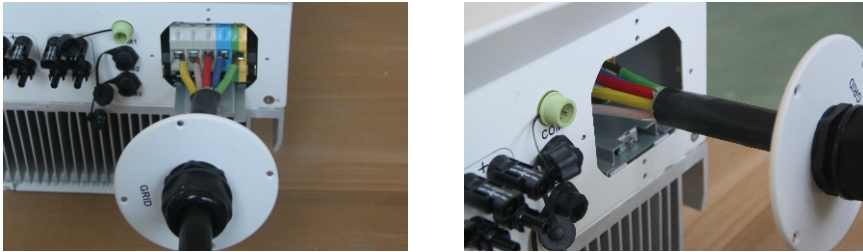

▲ Figure 5.17 Connect cable to AC terminal



WARNING:

Please do not put the insulating layer of the cable in to the terminal when tight the screws, otherwise it will cause poor contact.

D) Push the AC terminals along the rail to the inside of the inverter then tighten the screw under rack. Lock the 4 screws of AC terminal and tighten the cap nut of AC terminal. (as shown in figure 5.18)



▲ Figure 5.18 Tighten the AC terminal

5.3.3 Inverter monitoring connection

There are 3 communication terminals for Ginlong 20-40kW inverter. COM1-COM3 are all for RS485 communication. COM1 is 4-pin connector which matched with the Ginlong Wi-Fi or GPRS wireless communication products.

COM2 and COM3 are for RJ45 terminal, which is used for communicating connection between inverters as well as the wired data monitoring.

Figure 5.19 is the internet monitoring solution. Please refer to related instructions of Ginlong communication products.

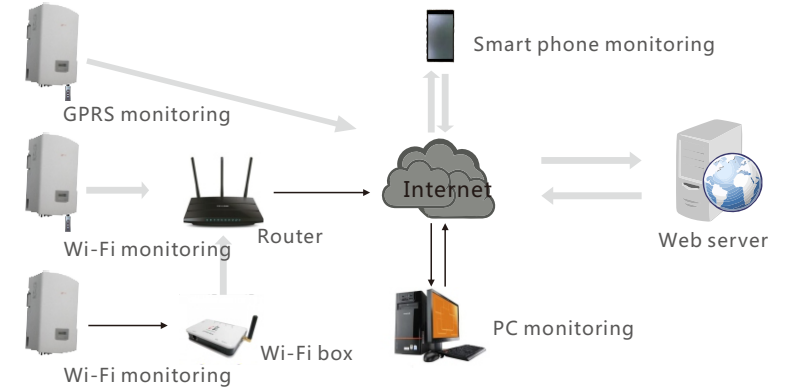

▲ Figure 5.19 Internet monitoring solution

Monitoring system for multiple inverters

The multi-inverters can be monitored by in series of RS485. (As shown in figure 5.20)

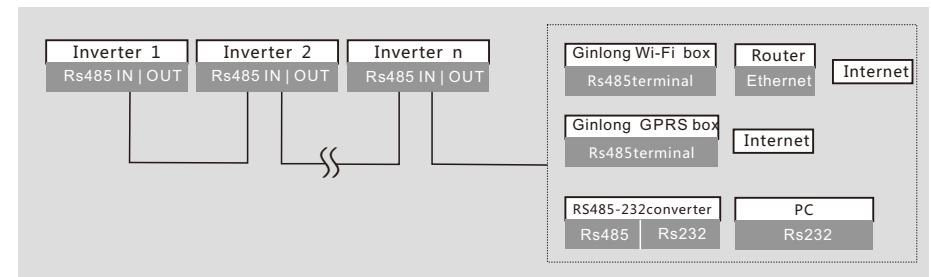

▲ Figure 5.20 Multi-inverters monitoring system

Rs485 communication connection of RJ45 network port

1. Insert the network cable into the communication connection terminal of RJ45. (As shown in figure 5.21)



▲ Figure 5.21 RJ45 communication connection terminals

5. Installation

2. Use the network wire stripper to strip the insulation layer of the communication cable. According to the standard line sequence TIA/EIA 568B, connect the wire to the plug of RJ45, and then use a network cable crimping tool to make it tight. Among the network cables, pin 1 (white and orange) and pin 4 (blue) is for RS485 +A; pin 2 (orange) and pin 5 (white and blue) is for RS485B. (As shown in figure 5.22)

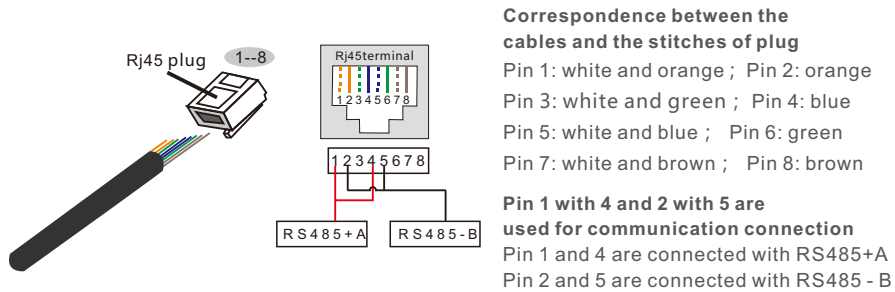

▲ Figure 5.22 Strip the insulation layer and connect to RJ45 plug

3. Connect the RJ45 to COM2 or COM3, and tighten the nut.



▲ Figure 5.23 Tighten the nut

4. For the cables of connecting the monitoring device or converter, the insulation of the communication cable needs to be stripped by a network wire stripper. Connect the corresponded signal wires of RS485 A/B to the monitoring device or RS232 converter. Pin 1 and 4 are defined as RS485+A while pin 2 and 5 are defined as RS485 - B.

6. Start and Stop

6.1 Start the inverter

To start up the Solis three phase string inverter, it is important to follow the steps here below:

1. Switch the Supply Main Switch (AC) ON first.
2. Turn on the DC switch of PV array. If the voltage of PV arrays is higher than the start up voltage, the inverter will turn on, and the initial interface of LCD will show "Current status: Waiting" on the upper left corner.

Current status: Waiting

3. Then the inverter will check both its internal parameters and the parameters of the AC and DC input to ensure that they are within the acceptable limits.

4. After around 30-180 second (based on local requirement), the inverter will start to generate power. The green LED will be on continually and the LCD displays "Current status: Generating."

Current status: Generating



NOTE:

If turn on DC input switch before grid breaker, inverter may show fault message "No_Grid" on current status, the fault will be clear if grid voltage is normal.

6.2 Stop the inverter

To stop the Solis three phase string inverter, it is important to follow the steps here below:

1. Switch the Supply Main Switch (AC) OFF.
2. Wait 10 seconds. Switch the DC switch OFF or directly disconnect the DC output connector. The LEDs and LCD of the inverter will be off within one minute.

7. General Operation

During normal operation, the initializing LCD shows the current status of the inverter, including the current power, total generation, and the bar chart of power operation, etc. Press ESC to switch from the initial interface to the details of monthly generation. Press ENTER to switch to the Main Menu.

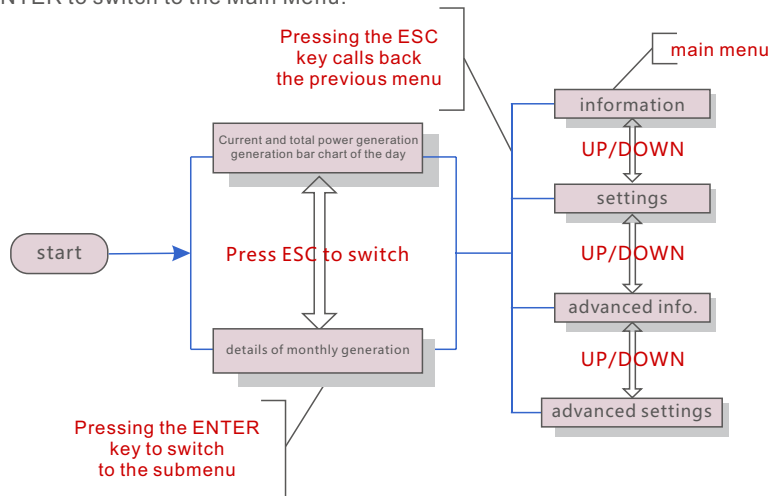

▲ Figure 7.1 Operation overview

7.1 Interface

The initial interface of the inverter shows the current operation status, current power, generation of the day/month/year, and total generation. And through the bar chart, we can view the generation information of the day.

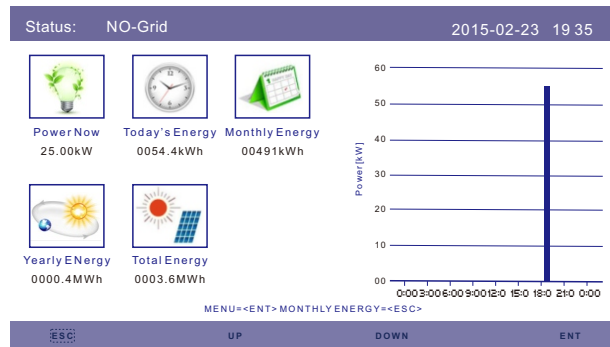

▲ Figure 7.2 The initial interface

7. General Operation

Press the Up or Down key to enter the inverter yearly, monthly energy detail screen. In the current interface, press the Enter key to move the cursor, press the Up or Down key to view yearly, monthly energy detail.

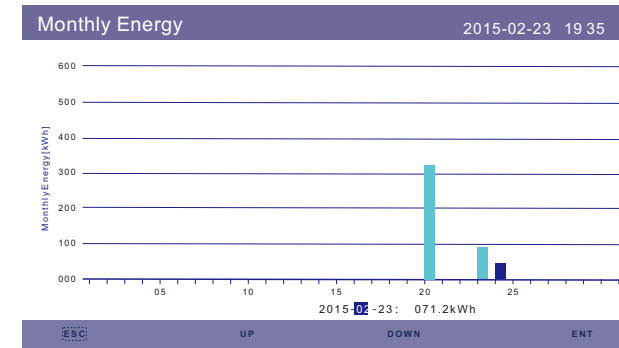

▲ Figure 7.2 Monthly energy detail

7.1.1 Main Menu

There are four submenu in the Main Menu:

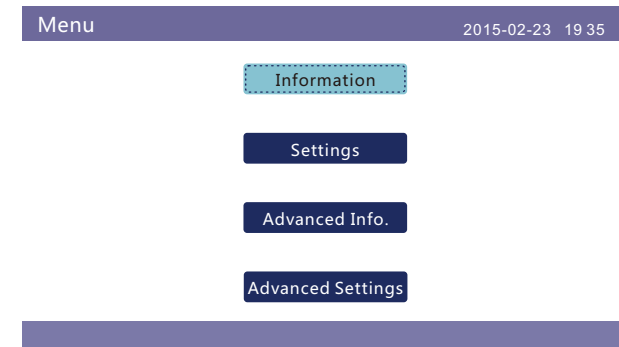

▲ Figure 7.3 Main Menu

7. General Operation

7.2 Information

The inverter LCD provides access to operational data and information. Select "Information" sub menu, turn the page by scrolling up or down.

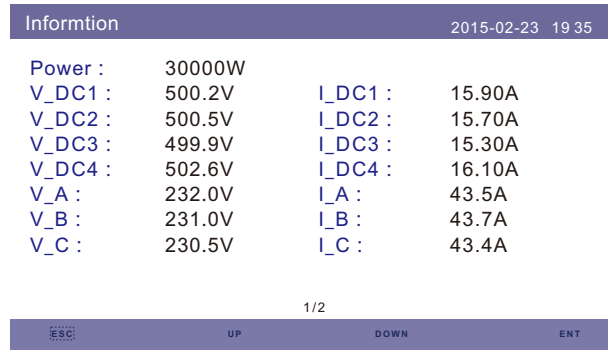

▲ Figure 7.4 Information (1)

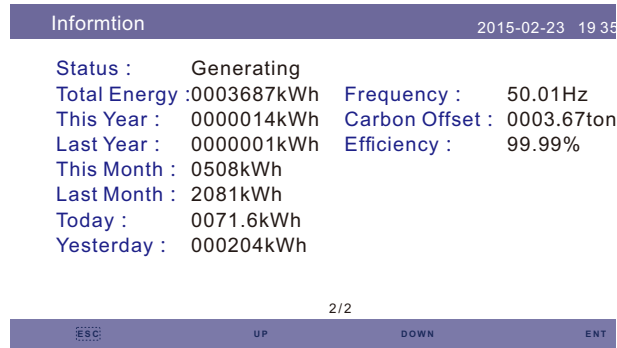

▲ Figure 7.5 Information (2)

7. General Operation

7.3 Settings

The following interface are displayed when the Settings menu is selected, and press the UP/DOWN keys to select different option, press the ENTER key to enter the submenu.

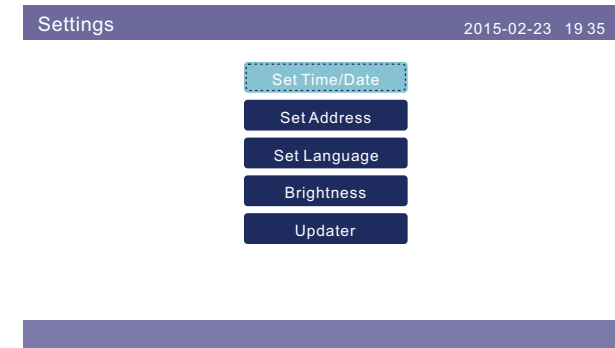

▲ Figure 7.6 Setting

7.3.1 Setting Time

This function allows time and date setting. When this function is selected, the LCD will display as screen as shown in Figure 7.7.

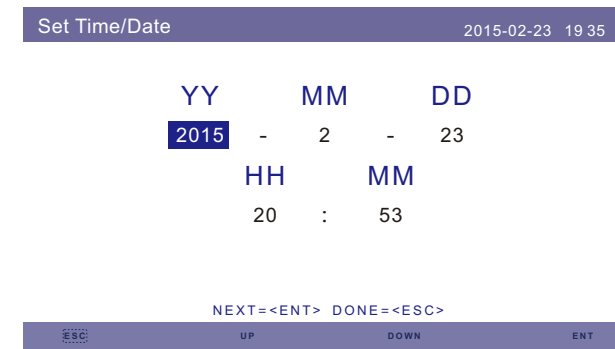

▲ Figure 7.7 Setting time

7. General Operation

Press the UP/DOWN keys to set time and data. Press the ENTER key to move from one digit to the next (from left to right). Press the ESC key to save the settings and return to the previous menu.

7.3.2 Setting Address

This function is used to set the address of an inverter connected to PC for communication purpose. The address number can be assigned from "01" to "99" (see Figure 7.8). The default address number of the inverter is "01".



▲ Figure 7.8 Address setting

Press the UP/DOWN keys to set the address. Press the ENTER key to save the settings. Press the ESC key to cancel the change and return to the previous menu.

7.3.3 Language Setting

This function is used to set the language of inverter LCD display.

7. General Operation

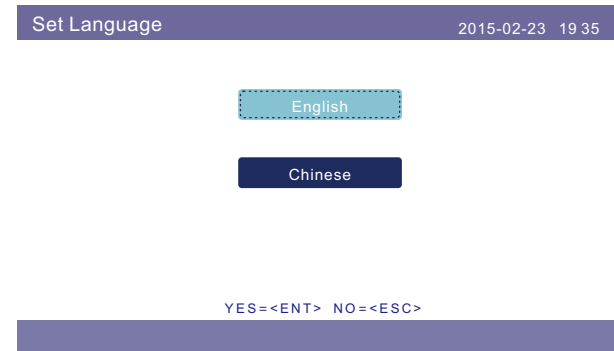

▲ Figure 7.9 Language settings

Press the UP/DOWN keys to set the address. Press the ENTER key to save the settings. Press the ESC key to cancel the change and return to the previous menu.

7.3.4 Screen Brightness Control

This function is used to set LCD screen brightness.

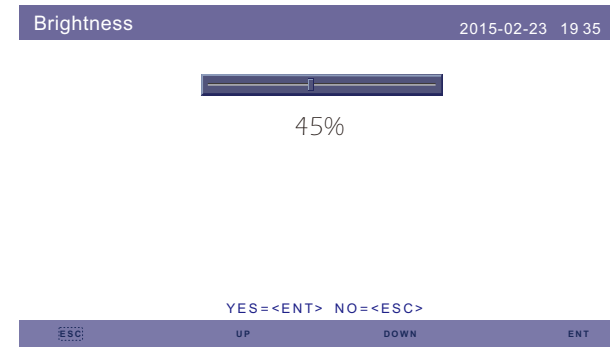

▲ Figure 7.10 Screen brightness adjustment

Press the UP/DOWN keys to set the brightness. Press the ENTER key to save the settings. Press the ESC key to cancel the change and return to the previous menu.

7. General Operation

7. General Operation

7.3.5 System Update

This function is used to view the current system version.

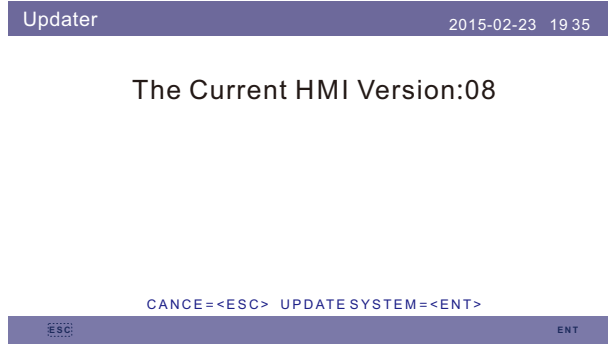

▲ Figure 7.11 System version

7.4 Advanced Info - Technicians Only



NOTE:

Password required – restricted access – authorised technicians only
Un-authorized access may void the warranty.

Select Advanced Info from main menu, the LCD screen show the password is needed:

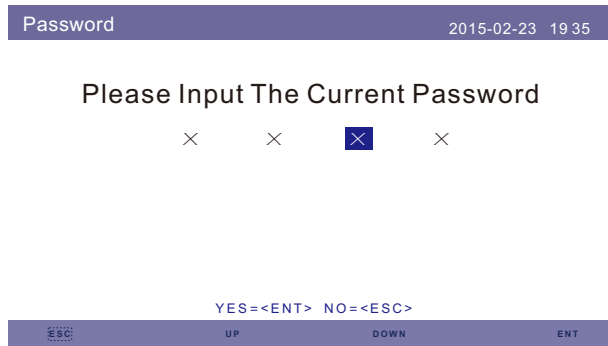

▲ Figure 7.12 Enter a password

The default password is "0010", press the DOWN key to move cursor, press the UP key to change the figure for input password, after entering correct password, the LCD will show as below:

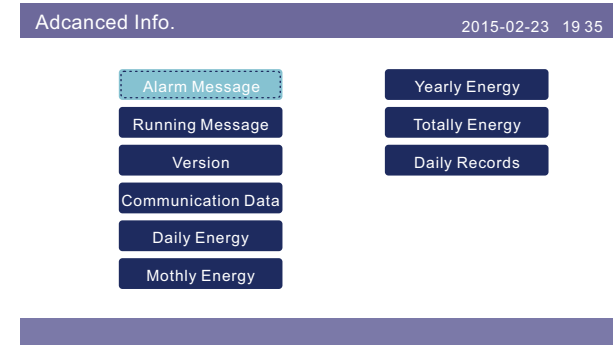

▲ Figure 7.13 Advanced information

The screen can be scrolled manually by pressing the UP/DOWN keys. Pressing the ENTER key gives access to a submenu.

7.4.1 Alarm Message

The display shows the 10 latest alarm messages (see Figure 7.14). Screens can be scrolled manually by pressing the UP/ DOWN keys.

Alarm Message			2015-02-23 19 35
Message	Date/Time	Data	
NO-Grid	02-23 19:35	0000	
NO-Grid	02-23 19:34	0000	
NO-Grid	02-23 19:34	0000	
NO-Grid	02-23 19:24	0000	
NO-Grid	02-23 18:22	0000	
	01/40		

The screenshot also shows a navigation bar at the bottom with 'ESC' on the left, 'UP' and 'DOWN' in the center, and 'ENT' on the right.

▲ Figure 7.14 Alarm message

7. General Operation

7.4.2 Operational Message

The screen shows the internal operation parameters of the inverter (see Figure 7.15).

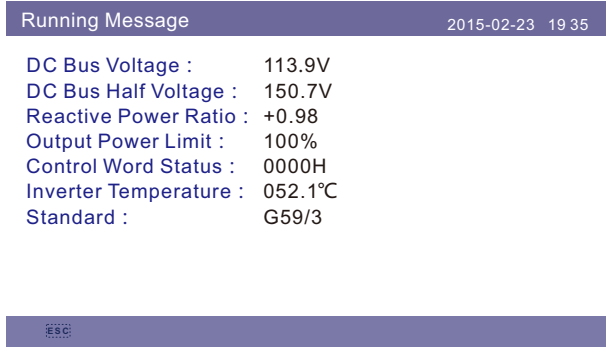

▲ Figure 7.15 Running information

7.4.3 Version No.

The screen shows the hardware version and the software version of the inverter (see Figure 7.16).



▲ Figure 7.16 Hardware and software versions

7. General Operation

7.4.4 Communication Data

The screen shows the internal data of the inverter (see Figure 7.17), which is for service technicians only.

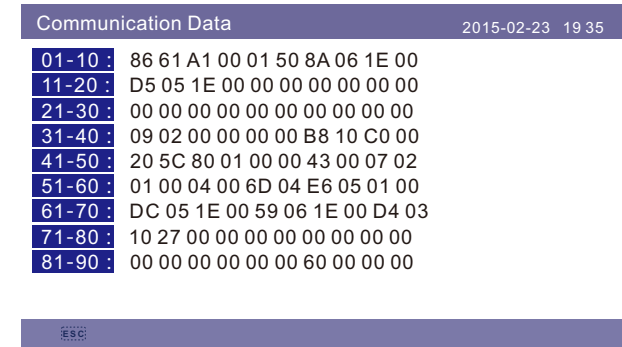

▲ Figure 7.17 Communication data

7.4.5 Daily Energy Information

The screen shows the daily energy detail of the inverter (see Figure 7.18).

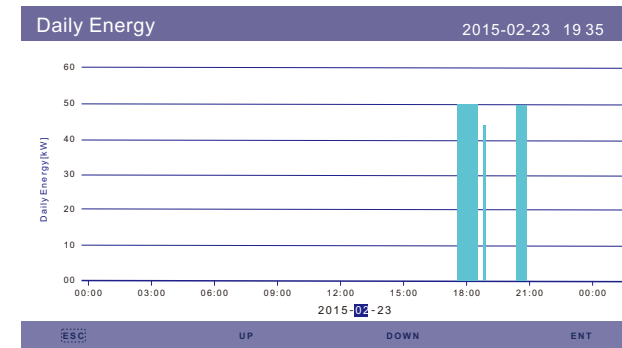

▲ Figure 7.18 Daily power generation capacity

Press the Enter key to move cursor, press the UP/DOWN keys to select energy power detail of different date.

7. General Operation

7. General Operation

7.4.6 Monthly Energy Detail

The screen shows the inverter daily energy detail of different month (see Figure 7.19).

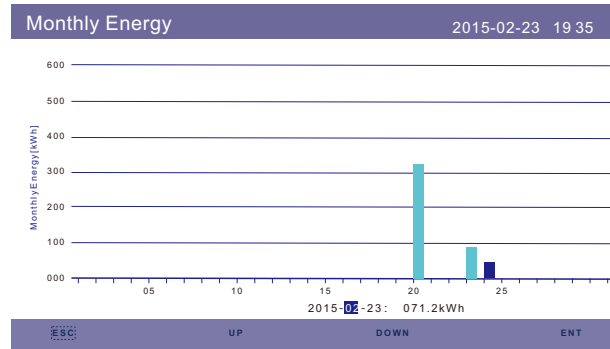

▲ Figure 7.19 Monthly power generation details

Press the Enter key to move cursor, press the UP/DOWN keys to select energy power detail of different date.

7.4.7 Yearly Energy Detail

The screen shows the inverter monthly energy detail of different year (see Figure 7.20).

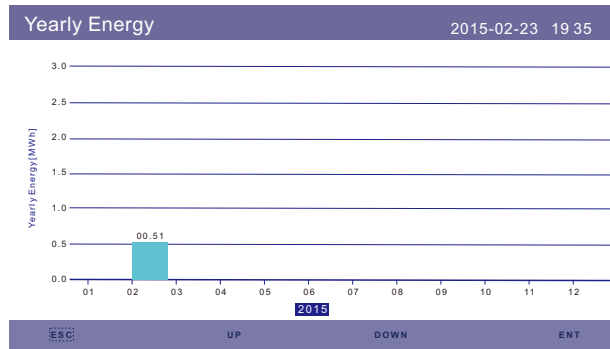

▲ Figure 7.20 Annual generating capacity details

Press the UP/DOWN keys to switch to view monthly energy of different year.

7.4.8 Total Energy Detail

The screen shows the inverter total energy detail(see Figure 7.21)

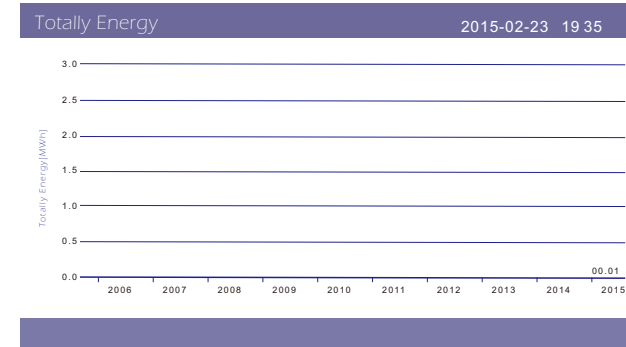

▲ Figure 7.21 Total generating capacity details

7.4.9 Work Log

The screen shows the inverter work log, related information is for Ginlong service technicians only.

Daily Records		
Message	Date/Time	Data
28C0	02-23 19:35	5E00
28C0	02-23 19:34	6400
28C0	02-23 19:34	6200
28C0	02-23 19:24	6200
28C0	02-23 18:22	0400
		01/40

▲ Figure 7.22 Working log

7. General Operation

7. General Operation

7.5 Advanced Settings - Technicians Only



NOTE:
 This function is for authorised technicians only. Improper access and operation may result in abnormal results and damage to the inverter.
 Password required – restricted access – authorised technicians only
 Un-authorized access may void the warranty.

Select Advanced Settings from the Main Menu to access the following options:

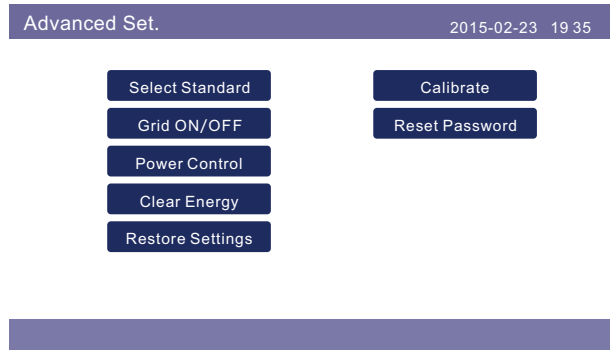

▲ Figure 7.23 Advanced settings

7.5.1 Select Grid Standard



NOTE:
 This is for service technicians only. The inverter is customized according to the local standard before shipping, there should be no requirement to set the standard.



NOTE:
 The "User-Def" function can be only used by the service engineer and changing protection level must be allowed by the local grid company.

Select grid standard (Figure 7.24)

Select Standard 2015-02-23 19 35

Select Standard
G59/3

YES=<ENT> NO=<ESC>
 ESC UP DOWN ENT

▲ Figure 7.24 Select national standards

Press the UP/DOWN keys to select the standard (AS4777, VDE4105, UL-1741, G59/3, CQC and "User-Def" function). Press the ENTER key to confirm the setting. Press the ESC key to cancel changes and returns to previous menu.

Selecting the User-Def submenu will access to the following submenu (see Figure 7.25):

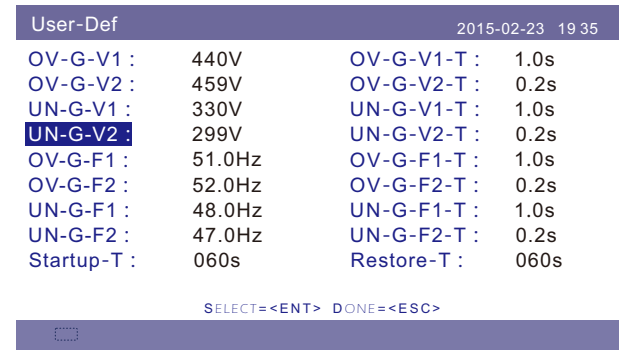

▲ Figure 7.25 User-Def

7. General Operation

Below is the setting range for User-Def. You may change the limit manually by using this function.

Solis-20K/Solis-25K/Solis-30K/Solis-30K-HE/Solis-36K-HV/Solis-40K-HV

OV-G-V1: 410---530V	OV-G-F1: 50.2-53Hz(60.2-63Hz)
OV-G-V1-T: 0.1---9S	OV-G-F1-T: 0.1---9S
OV-G-V2: 430---580V	OV-G-F2: 51-53Hz(61-63Hz)
OV-G-V2-T: 0.1---1S	OV-G-F2-T: 0.1---9S
UN-G-V1: 300---360V	UN-G-F1: 47-49.5Hz(57-59.5Hz)
UN-G-V1-T: 0.1---9S	UN-G-F1-T: 0.1---9S
UN-G-V2: 230---330V	UN-G-F2: 47-49Hz(57-59Hz)
UN-G-V2-T: 0.1---1S	UN-G-F2-T: 0.1---9S

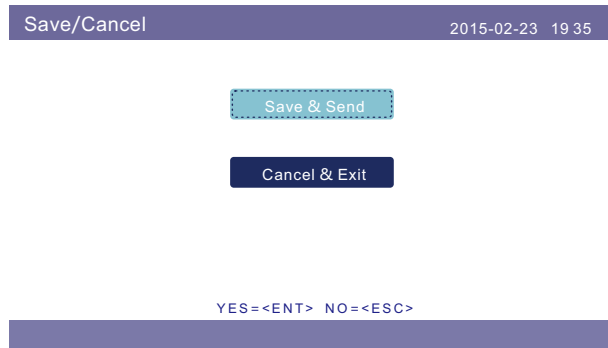

▲ Figure 7.26 Save / cancel



NOTE:

The initial value of the User-Def standard are for reference only. It does not represents the correct value suitable for use.

Press the UP/DOWN keys to scroll through items. Press the ENTER key to edit the highlighted item. Press the UP/DOWN key again to change the setting. Press the ENTER key to save the setting. Press the ESC key to cancel the change and return to the previous menu.

7. General Operation

7.5.2 Grid ON/OFF

This function is used to start or stop the generation of the inverter (see Figure 7.27).

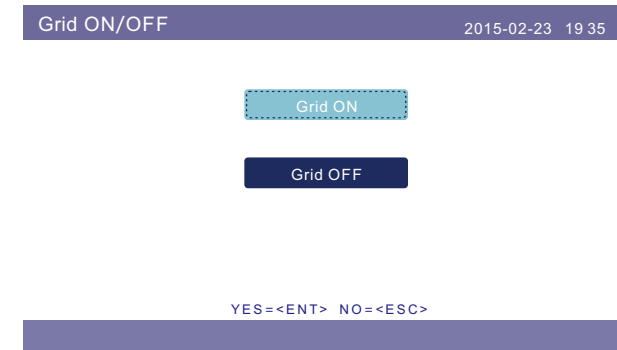

▲ Figure 7.27 Set Grid ON/OFF

Press the DOWN key to move the cursor, Press the UP key to revise the value. Press the ENTER key to execute the setting. Press the ESC key to return to the previous menu.

7.5.3 Power Setting

Active and reactive power can be set through power setting button.

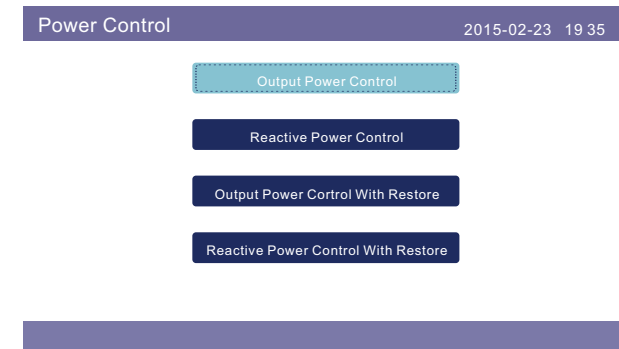

▲ Figure 7.28 Power setting

7. General Operation



This function is applicable by maintenance personnel only, wrong operation will prevent the inverter from reaching maximum power.

7.5.4 Clear Energy and Restore Factory Settings

Clear Energy can reset the history yield of inverter, restore factory settings means all the settings are restored to default settings.



These two functions are applicable by maintenance personnel only, wrong operation will prevent the inverter from working properly.

7.5.5 Calibrate Energy

Warranty or maintenance may result in resetting total generating data, this function allow the maintenance personnel to amend the total generating data of replacement inverter to the original one.

By using our data monitoring hardware, the data on monitoring website can automatically synchronize with the preset total generating power of inverter.

Calibrate

Total generating power: 0002616kWh



▲ Figure 7.29 Setting the total generating capacity

Press the DOWN key to move the cursor, Press the UP key to revise the value. Press the ENTER key to execute the setting. Press the ESC key to return to the previous menu.

7. General Operation

7.5.6 Change Password

First enter the current password, Press the DOWN key to move the cursor, press the UP key to revise the password figure.

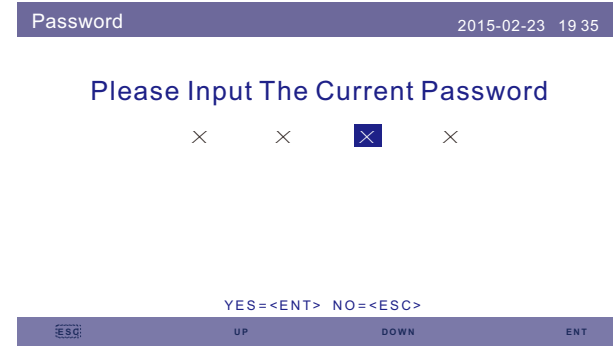

▲ Figure 7.30 Password setting

After entering the correct password, you can create a new password. Upon confirming the new password, press the ENTER key to execute the setting. (See Figure 7.31).

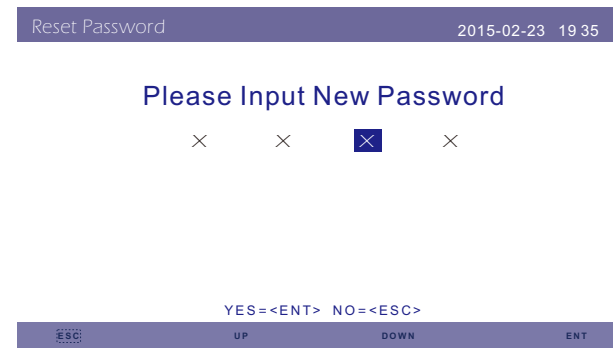

▲ Figure 7.31 Setting new password

8. Maintenance

Solis three phase string inverter does not require any regular maintenance. However, clean the heat-sink will help inverter dissipating heat and increase the life time of inverter. The dirt on the inverter can be cleaned with a soft brush.



CAUTION:

Do not touch the surface when the inverter is operating. Some parts may be hot and cause burns. Turn OFF the inverter (refer to Section 6.2) and let it cool down before you do any maintenance or cleaning of inverter.

The LCD and the LED status indicator lights can be cleaned with cloth if they are too dirty to be read.



Note:

Never use any solvents, abrasives or corrosive materials to clean the inverter.

9. Trouble Shooting

The inverter has been designed in accordance with international grid tied standards for safety, and electromagnetic compatibility requirements. Before delivering to the customer the inverter has been subjected to several tests to ensure its optimal operation and reliability.

In case of a failure the LCD screen will display an alarm message. In this case the inverter may stop feeding energy into the grid. The alarm descriptions and their corresponding alarm messages are listed in Table 9.1:

9. Trouble Shooting

Alarm Message	Alarm Description
OV-G-V	Grid Over Voltage
UN-G-V	Grid Under Voltage
OV-G-F	Grid Over Frequency
UN-G-F	Grid Under Frequency
NO-Grid	No Grid
G-PHASE	Grid Unbalance
G-F-FLU	Grid Frequency Fluctuation
OV-G-I	Grid Over Current
UNB-BUS	DC Bus Unbalance
OV-DC	DC Over Voltage
OV-BUS	DC Bus Over Voltage
UN-BUS	DC Bus Under Voltage
UNB2-BUS	DC Bus Unbalance 2
OV-DCA-I	DC(Channel A) Over Current
OV-DCB-I	DC(Channel B) Over Current
DC-INTF.	DC Over Current
GRID-INTF.	The Grid Interference Protection
INI-FAULT	The DSP Initial Protection
OV-TEM	Temperature Protection
GROUND-FAULT	Ground Fault
Relay-FAULT	Relay Protection
DSP-B-FAULT	DSP_B Protection
DCInj-FAULT	DC Injection Protection
12Power-FAULT	12V Under Voltage Faulty
lLeak-Check	Leakage Current Check Protection
AFCI-Check	AFCI Check Fault
ARC- FAULT	AFCI Fault

▲ Table 9.1 Alarm message and description

9. Trouble Shooting



NOTE:

If the inverter displays any alarm message as listed in Table 9.1; please turn off the inverter (refer to Section 6.2 to stop your inverter) and wait for 5 minutes before restarting it (refer to Section 5.1 to start your inverter). If the failure persists, please contact your local distributor or the service center. The below that we will need so that we can assist you.

1. Serial number of the Inverter;
2. The distributor/dealer of the Inverter (if available);
3. Installation date.
4. The description of problem (i.e. the alarm message displayed on the LCD and the status of the LED status indicator lights. Other readings obtained from the Information submenu (refer to Section 7.2) will also be helpful.);
5. Your contact details.

10. Specification

Model	Solis-20K	Solis-25K
The max DC input power	23kW	28kW
The max DC input voltage	1000V	
Starting-up input voltage	350V	
MPPT operation range	200 ~ 800V	
Max dc input current	18+18+18+18Adc	
Number of MPPT/strings per MPPT	4/8	
Rated output power	20kW	25kW
Rated grid voltage	380V	
The grid voltage range	304 ~ 460Vac(adjustable)	
Operation phase	Three phase	
Rated grid output current	28.7A	36.1A
Output power factor	>0.99	
Grid current THD	<3%	
The dc injection current	<50mA	
Rated grid frequency	50/60Hz	
Max. Efficiency	98.4%	
Protection	DC reverse-polarity; AC short circuit protection; Islanding protection; temperature protection;Lightning protection	
Size(mm)	530W*688H*356.5D	
Weight	57.2kg	58.2kg
Topology	Transformerless	
Internal consumption	<1W(Night)	
Operating temperature	-25 ~ 60°C	
Ingress protection	IP65	
Interface	Rs485 WIFI GPRS(Optional)	
Design lifetime	>20years	
Operating Range Utility Frequency	47-52 or 57-62Hz	
Utility Monitoring	Islanding protection, VA C FA C in accordance with UL 1741, G59/3, AS4777, VDE 0126-1-1, VDE 4105, CEI 0-21, CQC	
Operation Surroundings Humidity	0 ~ 95%	
EMC	EN61000-6-1:2007 EN61000-6-3:2007	

10. Specification

Model	Solis-30K
The max DC input power	34kW
The max DC input voltage	1000V
Starting-up input voltage	350V
MPPT operation range	200 ~ 800V
Max dc input current	18+18+18+18Adc
Number of MPPT/strings per MPPT	4/8
Rated output power	30kW
Rated grid voltage	380V
The grid voltage range	304 ~ 460Vac(adjustable)
Operation phase	Three phase
Rated grid output current	43.3A
Output power factor	>0.99
Grid current THD	<3%
The dc injection current	<50mA
Rated grid frequency	50/60Hz
Max. Efficiency	98.5%
Protection	DC reverse-polarity; AC short circuit protection; Islanding protection; temperature protection;Lightning protection
Size(mm)	530W*700H*356.5D
Weight	58.2kg
Topology	Transformerless
Internal consumption	<1W(Night)
Operating temperature	-25 ~ 60°C
Ingress protection	IP65
Interface	Rs485 WIFI GPRS(Optional)
Design lifetime	>20years
Operating Range Utility Frequency	47-52 or 57-62Hz
Utility Monitoring	Islanding protection, VA C FA C in accordance with UL 1741, G59/3, AS4777, VDE 0126-1-1, VDE 4105, CEI 0-21, CQC
Operation Surroundings Humidity	0 ~ 95%
EMC	EN61000-6-1:2007 EN61000-6-3:2007

10. Specification

Model	Solis-30K-HE
The max DC input power	34kW
The max DC input voltage	1000V
Starting-up input voltage	600V
MPPT operation range	575 ~ 850V
Max dc input current	52.2Adc
Number of MPPT/strings per MPPT	1/8
Rated output power	30kW
Rated grid voltage	380V
The grid voltage range	304 ~ 460Vac(adjustable)
Operation phase	Three phase
Rated grid output current	43.3A
Output power factor	>0.99
Grid current THD	<3%
The dc injection current	<50mA
Rated grid frequency	50/60Hz
Max. Efficiency	99.0%
Protection	DC reverse-polarity; AC short circuit protection; Islanding protection; temperature protection;Lightning protection
Size(mm)	530W*700H*356.5D
Weight	50kg
Topology	Transformerless
Internal consumption	<1W(Night)
Operating temperature	-25 ~ 60°C
Ingress protection	IP65
Interface	Rs485 WIFI GPRS(Optional)
Design lifetime	>20years
Operating Range Utility Frequency	47-52 or 57-62Hz
Utility Monitoring	Islanding protection, VA C FA C in accordance with UL 1741, G59/3, AS4777, VDE 0126-1-1, VDE 4105, CEI 0-21, CQC
Operation Surroundings Humidity	0 ~ 95%
EMC	EN61000-6-1:2007 EN61000-6-3:2007

10. Specification

Model	Solis-36K-HV	Solis-40K-HV
The max DC input power	41kW	45kW
The max DC input voltage	1000V	
Starting-up input voltage	350V	
MPPT operation range	200 ~ 800V	
Max dc input current	18+18+18+18A	
Number of MPPT/strings per MPPT	4/8	
Rated output power	36kW	40kW
Rated grid voltage	480V	
The grid voltage range	384 ~ 576Vac(adjustable)	
Operation phase	Three phase	
Rated grid output current	43.3A	48.1A
Output power factor	>0.99	
Grid current THD	<3%	
The dc injection current	<50mA	
Rated grid frequency	50/60Hz	
Max. Efficiency	98.6%	
Protection	DC reverse-polarity; AC short circuit protection; Islanding protection; temperature protection;Lightning protection	
Size(mm)	530W*700H*356.5D	
Weight	58.2kg	
Topology	Transformerless	
Internal consumption	<1W(Night)	
Operating temperature	-25 ~ 60°C	
Ingress protection	IP65	
Interface	Rs485 WIFI GPRS(Optional)	
Design lifetime	>20years	
Operating Range Utility Frequency	47-52 or 57-62Hz	
Utility Monitoring	Islanding protection, VA C FA C in accordance with UL 1741, G59/3, AS4777, VDE 0126-1-1, VDE 4105, CEI 0-21, CQC	
Operation Surroundings Humidity	0 ~ 95%	
EMC	EN61000-6-1:2007 EN61000-6-3:2007	