



X1-Fit User Manual

3.7kW - 7.5kW



EN



SolaX Power Network Technology(Zhe jiang) Co., Ltd.

ADD:No.288 Shizhu Road, Tonglu Economic Development Zone,
Tonglu City, Zhejiang Province, China.

Tel:+0571-5626 0011

E-mail: info@solaxpower.com

614.00521.01

Copyright Declaration

The copyright of this manual belongs to SolaX Power Network Technology(Zhe jiang) Co.,Ltd. Any corporation or individual should not plagiarize, partially or fully copy (including software, etc.), and no reproduction or distribution of it in any form or by any means. All rights reserved. SolaX Power Network Technology (Zhe jiang) Co.,Ltd. reserves the right of final interpretation. The contents are subject to change without prior notice.

www.solaxpower.com

Contents

1 Note on this Manual	03
1.1 Scope of Validity	03
1.2 Target Group	03
1.3 Symbols Used	03
1.3.1 Important Safety Instructions.....	04
1.3.2 Explanation of Symbols.....	08
1.3.3 CE Directives.....	10
2 Introduction	11
2.1 Basic Feature	11
2.2 Electrical Block Diagram of The System.....	11
2.3 Work Modes.....	14
2.4 Dimension.....	17
2.5 Terminals of Inverter.....	18
3 Technical Data	19
3.1 AC Output/Input	19
3.2 Battery.....	19
3.3 Efficiency, Safety and Protection.....	20
3.4 EPS Output	20
3.5 General Data.....	21
4 Installation	22
4.1 Check for Transport Damage	22
4.2 Packing List	22
4.3 Installation Precautions	24
4.4 Tool Preparation.....	25
4.5 Installation Site Conditions	27
4.5.1 Installation Carrier Requirements.....	27
4.5.2 Installation Requirements.....	27
4.5.3 Installation Space Requirements.....	28
4.6 Mounting.....	29

5 Electrical Connections.....32

5.1 Grid Port and EPS Output Connection32

5.2 EPS Block Diagram.....33

5.3 Battery Connection42

5.4 Communication Connection.....44

5.4.1 Introduction to DRM Communication.....47

5.4.2 Introduction to Meter/CT Communication.....48

5.4.3 Parallel Connection.....52

5.4.4 COM Communication.....58

5.4.5 Communication Connection Steps.....64

5.5 Grounding (mandatory).....65

5.6 Monitoring Connection.....67

5.7 Check All Below Steps Before Starting Inverter.....68

5.8 Inverter Operation.....68

6 Firmware upgrading.....69

7 Setting.....73

7.1 Control Panel.....73

7.2 Menu Structure.....74

7.3 LCD Operation.....75

8 Troubleshooting.....101

8.1 Trouble Shooting.....101

8.2 Routine Maintenance.....107

9 Decommissioning.....108

9.1 Disassemble the Inverter.....108

9.2 Packaging.....108

9.3 Storage and Transportation.....108

9.4 Waste Disposal108

10 Disclaimer.....109

✧ **WARRANTY REGISTRATION FORM**

1 Notes on this Manual

1.1 Scope of Validity

This manual is an integral part of X1-Fit G4, It describes the assembly, installation, commissioning, maintenance and failure of the product. Please read it carefully before operating.

X1-Fit-3.7-W	X1-Fit-5.0-W	X1-Fit-6.0-W	X1-Fit-7.5-W
X1-Fit-3.7-M	X1-Fit-5.0-M	X1-Fit-6.0-M	X1-Fit-7.5-M

Note: "X1-Fit G4" Series refers to the energy storage inverter that supports grid-connected.

"5.0" means 5.0kW.

"W" means that Matebox cannot be connected externally, and "M" means that Mate box can be connected externally for EPS operation with full load.

Keep this manual available at any time.

1.2 Target Group

This manual is for qualified electricians. The tasks described in this manual only can be performed by qualified electricians.

1.3 Symbols Used

The types of safety instructions and general information appear in this document are as described below:



Danger!

"Danger" refers to a dangerous situation that, if not avoided, will result in a high degree of danger, serious injury, or even death.



Warning!

"Warning" indicates a dangerous situation, which, if not avoided, may result in serious injury or death.



Caution!

"Caution" indicates a hazardous situation which, if not avoided, could result in minor or moderate injury.



Note!

"Note" provides tips that are valuable for the optimal operation of our product.

1.3.1 Important Safety Instructions



Danger!

Danger to life due to high voltages in the inverter! The personnel responsible for the installation, electrical connection, debugging, maintenance and fault handling operation of this product need to be trained, master the correct operation method, have the corresponding electrician qualification and safety operation knowledge.



Caution!

When the inverter is working, it is strictly forbidden to touch the shell. The temperature of the shell is high and there is a risk of scalding.



Caution!

Radiation may be harmful to health!
Do not stay for a long time and keep at least 20 cm away from the inverter.



Warning!

Authorized service personnel must disconnect the AC and DC power supply of the inverter before performing any maintenance, cleaning or operation of any circuit connected to the inverter.



Warning!

Do not operate the inverter when the device is running.



Warning!

Risk of electric shock!

Strictly follow relevant safety specifications for product installation and testing. During installation, operation or maintenance, please read carefully and follow the instructions and precautions on the inverter or user manual. If the operation is incorrect, it may cause personal and property losses. Please keep the user manual properly after use.

This inverter can only use the accessories sold and recommended by SolaX, otherwise it may cause fire, electric shock or casualties. Without the authorization of our company, you may not open the inverter cover or replace the inverter parts, otherwise the warranty promise of the inverter will be invalid.

The use and operation of the inverter must be carried out in accordance with the instructions in this manual, otherwise this protection will fail and the warranty of the inverter will also fail. During working, the inverter surface temperature may exceed 60°C, please make sure the inverter cools down before touching, and make sure children can not touch.

AC power sources must be disconnected from the inverter for at least 5 minutes before any wiring or electrical operation is performed on the inverter to ensure complete isolation of the inverter and avoid electric shock.

Installation position should be away from wet environment and corrosive substances.

Use a multimeter (impedance at least 1 Mohm) to measure the voltage between the UDC+ and the UDC- to ensure that the inverter port is discharged below the safe voltage before starting operation (35 VDC).

Direct or indirect lightning strikes can cause failures. Surge is the main cause of lightning damage to most devices. Surge voltage may occur at AC output, especially in remote mountain areas where long distance cable is supplied.

Please consult professionals before installing SPDs.

The external lightning protection device can reduce the influence of direct lightning strike, and the lightning protection device can release surge current to the earth.

If the building installed with external light protection device is far away from the inverter location, in order to protect the inverter from electrical and mechanical damage, the inverter should also install an external lightning protection equipment.

In order to protect the AC system, the level 2 surge protection equipment should be installed at the AC output, located between the inverter and the grid. Concrete installation shall conform to IEC61643-21 standards.

➤ Anti-islanding Effect

The islanding effect means that when the power grid is cut off, the grid-connected power generation system fails to detect the power outage and still supplies power to the power grid. This is very dangerous for the maintenance personnel and the power grid on the transmission line.

X1-Fit G4 series inverters use active frequency offset method to prevent islanding effect.

➤ PE Connection and Leakage Current

- All inverters incorporate a certified internal Residual Current Device (RCD) in order to protect against possible electrocution and fire hazard in case of a malfunction in the cables or inverter. There are 2 trip thresholds for the RCD as required for certification (IEC 62109-2: 2011). The default value for electrocution protection is 30mA, and for slow rising current is 300mA.
- If an external RCD is required by local regulations, check which type of RCD is required for relevant electric code. It recommends using a type-A RCD. The recommended RCD values is 100mA or 300mA unless a lower value is required by the specific local electric codes. When required by local regulations, the use of an RCD type B is permitted.

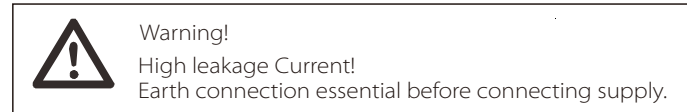

- A faulty ground connection can result in equipment failure, personal and death injuries, and electromagnetic interference.
- Ensure correct according to grounding to IEC62109 and conductor diameter according to STANDARD specification.
- Do not connect the grounding end of the equipment in series to prevent multi-point grounding.
- Electrical appliances must be installed in accordance with the wiring rules of each country.

For United Kingdom

- The installation that connects the equipment to the supply terminals shall comply with the requirements of BS 7671.
- All protective devices cannot be changed.
- User shall ensure that equipment is so installed, designed and operated to maintain at all times compliance with the requirements of ESQCR22(1)(a).

➤ Battery Safety



SolaX X1-Fit G4 Series inverter should pair with high voltage battery, for the specific parameters such as battery type, nominal voltage and nominal capacity etc., please refer to section 3.2.

Please refer to the matching battery specification for details.







1.3.2 Explanation of Symbols







This section gives an explanation of all the symbols shown on the inverter and on the type label

• Symbols on the Inverter

Symbol Explanation	Explanation
	Operating Display
	Battery status
	An error has occurred, please inform your installer immediately

• Symbols on the Type Label

Symbols	Explanation
	CE mark. The inverter complies with the requirements of the applicable CE guidelines.
	UKCA mark. The inverter complies with the requirements of the applicable UKCA guidelines.
	UKNI mark. The inverter complies with the requirements of the applicable UKNI guidelines.
	TUV certified.
	RCM remark.
	SAA certification.

	Beware of hot surface. The inverter can become hot during operation. Avoid contact during operation.
	Danger of high voltages. Danger to life due to high voltages in the inverter!
	Danger. Risk of electric shock!
	Observe enclosed documentation.
	The inverter can not be disposed together with the household waste. Disposal information can be found in the enclosed documentation.
	Do not operate this inverter until it is isolated from battery and mains.
	Danger to life due to high voltage. There is residual voltage existing in the inverter after powering off, which needs 5 min to discharge. Wait 5 min before you open the upper lid or the DC lid.

1.3.3 CE Directives

This chapter describes the requirements of the European low voltage regulations, including safety instructions and system licensing conditions, the user must comply with these regulations when installing, operating, and maintaining the inverter, otherwise it will cause personal injury or death, and the inverter will cause damage.

Please read the manual carefully when operating the inverter. If you do not understand "danger", "warning", "caution" and the description in the manual, please contact the manufacturer or service agent before installing and operating the inverter.

The assembly shall be installed in accordance with the statutory wiring rules. Install and configure the system in accordance with safety rules, including the use of specified wiring methods. The installation of the system can only be done by professional assemblers who are familiar with safety requirements and EMC. The assembler shall ensure that the system complies with the relevant national laws.

The interconnection of the individual components of the system shall be conducted in accordance with the wiring methods outlined in national and international guidelines, such as national Electrical Code (NFPA) No.70 or VDE Code 0107.

2 Introduction

2.1 Basic Features

X1-Fit G4 Series is a high-quality inverter which can store energy into battery.

The inverter can be used to optimize self consumption, store in the battery for future use or feed-in to public grid. Work mode depends on the battery and user's preference. It can provide power for emergency use during the grid lost by using the energy from battery.

2.2 Electrical Block Diagram of The System

X1-Fit G4 series are designed to have two EPS wiring schemes, customers can choose EPS compatible parts Load and EPS compatible with all load use.

There are different ways of wiring in different countries, one is to connect N line with PE line, the other is to separate the line from the PE line wiring, see below;

Diagram A: Neutral line and PE line are separated from each other, and the common load is connected to the EPS port; (For most countries)

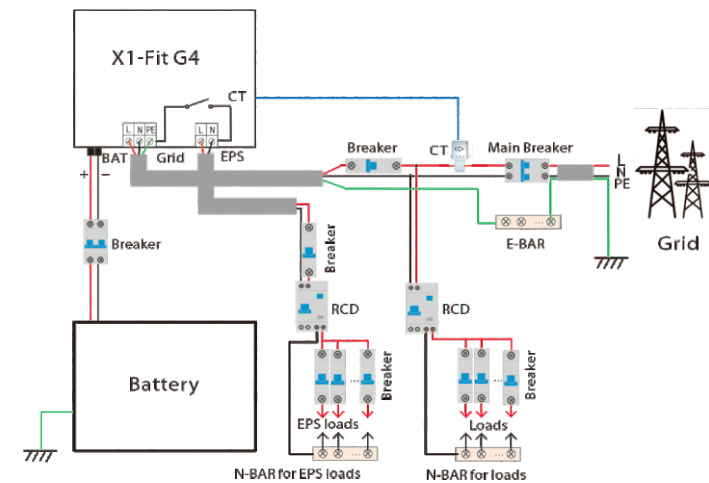

Diagram B: Neutral line and PE line are separated from each other, all loads connect to the EPS port;(For most countries)

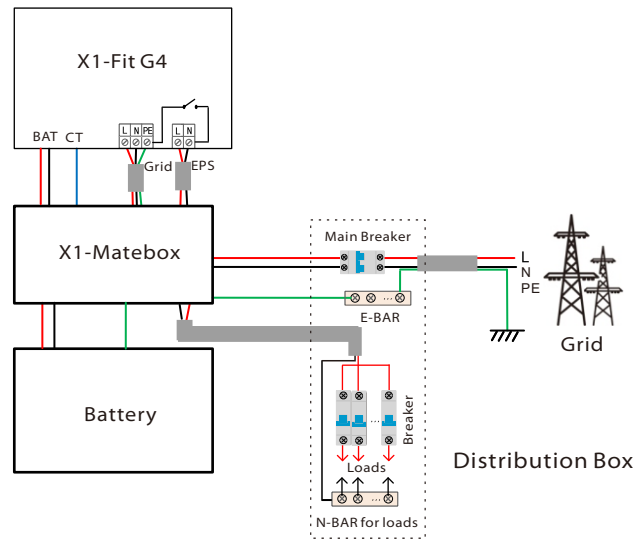

Diagram C: Neutral line and PE line are combined together, and the common load is connected to the EPS port;(Apply to Australia)

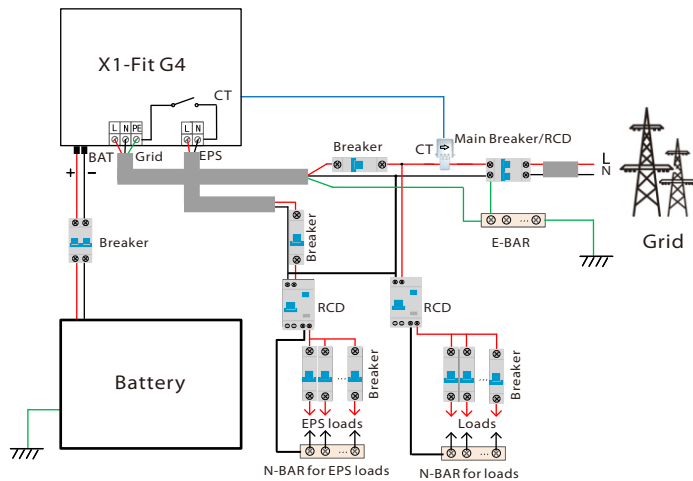
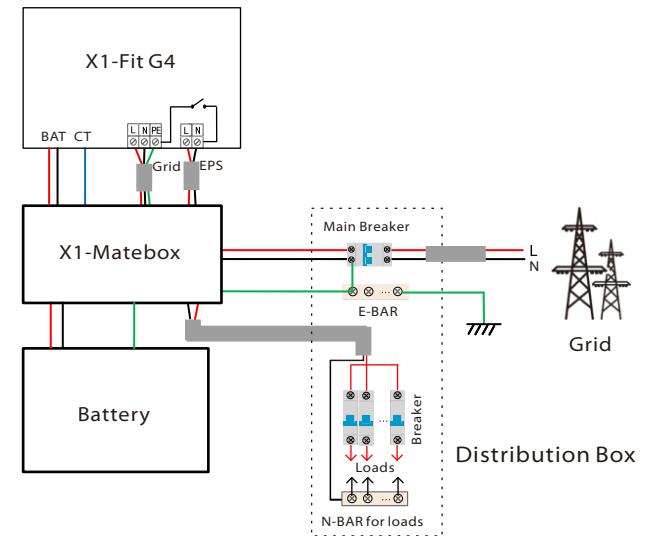
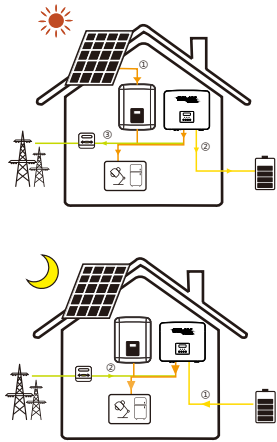

Diagram D: Neutral line and PE line are combined together, all loads connect to the EPS port;(Apply to Australia)



X1-Matebox is a convenient wiring and accessory that can realize EPS full load. For more information, please refer to X1-Matebox. If you need to buy X1-Matebox, please contact us.

In full load scheme **Diagram B** and **Diagram D**, set "X1-Matebox" to "Enable" under Settings; The Australian customer must shorten the N lines of the Grid and the EPS in the X1-Matebox. If your local wiring method does not follow the above operation guide, especially the neutral wire, ground wire, RCD wire, please contact our company before operation.



Backup mode

The back-up mode is suitable for areas with frequent power outages. Same working logic with "Self-use" mode. This mode will maintain the battery capacity at a relatively high level. (Users' setting) to ensure that the emergency loads can be used when the grid is off. Customers no need to worry about the battery capacity. Battery min SOC can be set: 30%-100% Charge battery to SOC can be set: 30%-100%.

EPS

The EPS is used when the power grid is off. In case of power failure, the battery will provide emergency power for household electricity. (Battery is necessary in EPS mode)

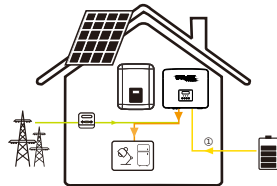

① Without PV power
The battery will power the emergency loads until the battery reached the min SOC, and then the inverter will enter an idle status.
(PV=0, Battery → Load)

EPS SOC-min condition is adjustable within the range of 10%-25%;

Note: in the case of grid connection, all working modes work normally when the battery SOC >5%. When the battery charge rate is below 5%, the PV or Grid will first charge the battery SOC 11%, and then return to the working mode selected by the user.

2.4 Dimension

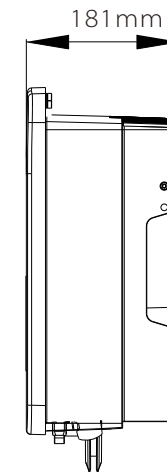
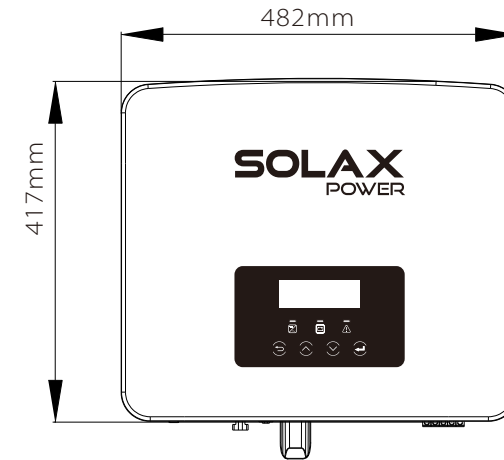

2.3 Work Modes

X1-Fit G4 Series inverter provides multiple work modes based on different requirements. (The following mode is a description of the scene that X1-Fit G4 works with other grid-connected inverter)

Self Use

The self-use mode is suitable for areas with low feed-in subsidies and high electricity prices.

① When the power of PV is sufficient
Active Charging or Discharge time period: PV will power the loads firstly, and surplus power will charge to the battery. If the battery is fully charged, then sell the surplus power to the grid; (The inverter will limit the output if Feed-in limit or zero feed-in is needed)

(PV > Load, PV → Load → Battery → Grid)

② When the power of PV is insufficient
Active Charging time period: PV will power the loads firstly, the remaining power will be taken from the grid, the battery will not discharge at this time.

(PV < Load, PV + Grid → Load)

Active Discharge time period: PV+BAT will power the loads together. If the power is still not enough, the remaining power will be taken from the grid.

(PV < Load, PV + Battery + Grid → Load)

③ Without PV power

Active Charging time period: The grid supplies the loads and also can charge the battery;

(PV=0, Grid → Load + Battery)

Active Discharge time period: The battery will power the home loads firstly. If the battery power is not enough, the remaining power will be taken from the grid. Then the inverter will enter into the idle mode.

(PV=0, Battery+Grid → Load)

Battery min SOC can be set: 10%-100%

Charge battery to SOC can be set: 10%-100%

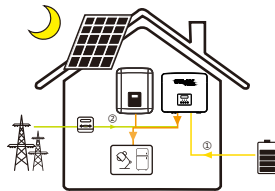
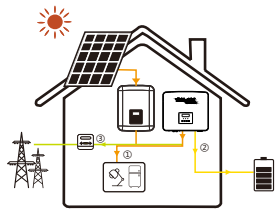

Feed-in priority

The Feed-in priority mode is suitable for areas with high feed-in subsidies, but has feed-in power limitation.

① When the power of PV is sufficient
Active Charging time period: First, PV supply power to the load, then charge the battery to the set capacity, and then sell the power to the grid. If the local grid company limits the grid-connected power of the inverter, the excess energy continues to charge the battery.

(PV > Load, PV → Load → Battery → Grid → Battery)

Active Discharge time period: PV will power the loads firstly, and surplus power will feed-in to the grid.

(PV > Load, PV → Load → Grid)

② When the power of PV is insufficient

Active Charging time period: PV will power the loads firstly, the remaining power will be taken from the grid. The battery will not discharge.

(PV < Load, PV + Grid → Load)

Discharge time period: PV+BAT will power the loads together.

If the power is still not enough, the remaining power will be taken from the grid.

(PV < Load, PV + Battery + Grid → Load)

③ Without PV power

Active Charging time period: The grid will power the home loads and also charge the battery;

(PV=0, Grid → Load + Battery)

Active Discharge time period: The battery will power the home loads firstly. If the battery power is not enough, the remaining power will be taken from the grid. the inverter will enter into the idle mode.

(PV=0, Battery+Grid → Load)

Battery min SOC can be set: 10%-100%

Charge battery to SOC can be set: 10%-100%

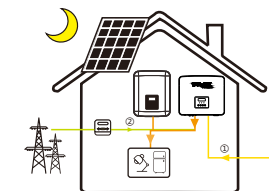
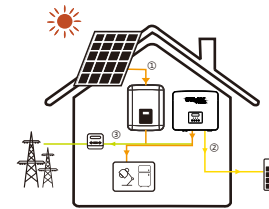

2.5 Terminals of Inverter

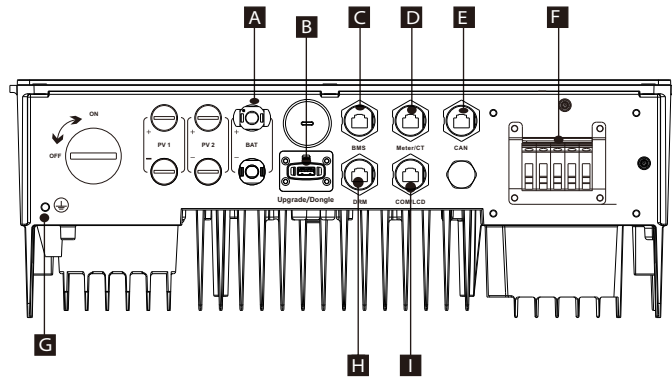

Object	Description
A	Battery connection port
B	USB port for upgrading/External monitoring connection port
C	Battery communication
D	Meter/CT Port
E	Communication port for parallel operation
F	Load/EPS Output
G	Ground connection port
H	DRM Port(only for Australia)
I	Communications/ LCD external screen ports



Warning!

Qualified electrician required for the installation.

3 Technical Data

3.1 AC Output/Input

Model	X1-Fit -3.7-W X1-Fit -3.7-M	X1-Fit -5.0-W X1-Fit -5.0-M	X1-Fit -6.0-W X1-Fit -6.0-M	X1-Fit -7.5-W X1-Fit -7.5-M
AC Output				
Nominal AC power [VA]	3680	5000(Germany 4600, AU4999)	6000	7500
Max. apparent AC power [VA]	3680	5500(Germany 4600, AU4999)	6600	7500
Rated AC voltage [V]	220/230/240 (180 to 270)			
Rated grid frequency [Hz]	50/60			
Max. AC current [A]	16	23.9(Germany20, AU21.7)	28.6	32.6
Displacement power factor	0.8 leading...0.8 lagging			
Total harmonic distortion(THDi)	< 2%			
AC Input				
Max. apparent power [VA]	7360	9200	9200	9200
Rated AC power [W]	3680	5000	6000	7500
Rated grid voltage(range)[V]	220/230/240 (180 to 270)			
Rated grid frequency [Hz]	50/60			
Max. AC current [A]	32	40	40	40
Displacement power factor	0.8 leading...0.8 lagging			

3.2 Battery

Model	X1-Fit -3.7-W X1-Fit -3.7-M	X1-Fit -5.0-W X1-Fit -5.0-M	X1-Fit -6.0-W X1-Fit -6.0-M	X1-Fit -7.5-W X1-Fit -7.5-M
Battery type	Lithium batteries			
Battery Full Voltage [V]	80-480			
Maximum charge/discharge flow [A]	30A			
Communication interface	CAN/RS485			
Reverse connection protection	Yes			

3.3 Efficiency, Safety and Protection

Model	X1-Fit -3.7-W	X1-Fit -5.0-W	X1-Fit -6.0-W	X1-Fit -7.5-W
	X1-Fit -3.7-M	X1-Fit -5.0-M	X1-Fit -6.0-M	X1-Fit -7.5-M
Max. battery charge efficiency (AC to BAT)(@ full load)	97.0%	97.0%	97.0%	97.0%
Max. battery discharge efficiency (BAT to AC)(@ full load)	97.0%	97.0%	97.0%	97.0%
Security & Protection				
AC SPD Protection	Integrated(Typelll)			
Over/under voltage protection	YES			
Grid protection	YES			
DC injection monitoring	YES			
Back feed current monitoring	YES			
Residual current detection	YES			
Anti-islanding protection	YES			
Overload protection	YES			
Overheat protection	YES			

3.4 EPS Output

Model	X1-Fit -3.7-W	X1-Fit -5.0-W	X1-Fit -6.0-W	X1-Fit -7.5-W
	X1-Fit -3.7-M	X1-Fit -5.0-M	X1-Fit -6.0-M	X1-Fit -7.5-M
EPS rated [VA] power	3680	5000	6000	7500
EPS rated voltage [V]	230VAC			
Frequency [Hz]	50/60			
EPS rated current [A]	16	21.7	26.1	32.6
EPS Peak Power [VA]	120%rated,3600s	120%rated,3600s	120%rated,600s	100%rated
Switching time [ms]	internal switch<10,external switch<100			
Total harmonic distortion (THDv)	<2%			

3.5 Generic Data

Model	X1-Fit -3.7-W	X1-Fit -5.0-W	X1-Fit -6.0-W	X1-Fit -7.5-W
	X1-Fit -3.7-M	X1-Fit -5.0-M	X1-Fit -6.0-M	X1-Fit -7.5-M
Dimensions [W/H/D](mm)	482*417*181			
Packing size [W/H/D](mm)	590*530*315			
Net weight [kg]	23	23	23	23
Gross weight [kg]	27	27	27	28
Heat dissipation treatment	Natural Cooling			Smart Cooling
Noise emission(typical)[dB]	<30			<45
Storage temperature range [°C]	-40~+65			
Operating temperature range[°C]	-35~+60 (derating at 45)			
Humidity [%]	0%~100% (no condensation)			
Altitude [m]	<3000			
Protection level	IP65			
Security level	I			
Night consumption	<3W			
Overvoltage category	III(MAINS),II(Battery)			
Pollution Degree	III			
Installation mode	Wall mounted			
Inverter Topology	Transformerless			
Communication interface	Meter/CT, external control RS485, indoor LCD, Pocket series, DRM, USB,CAN			

4 Installation

4.1 Check for Transport Damage

Ensure that the inverter is in good condition via transportation. If there is any visible damage such as cracks, please contact the dealer immediately.

4.2 Packing List

Open the package and check the materials and accessories according to the following list.



Number	Quantity	Description
A	1	X1-Fit G4 series inverter
B	1	Bracket
C [☆]	1	Waterproof cover
D	1	RJ 45 terminals
E [☆]	2	5-6mm ² European terminals
F [☆]	3	8-10mm ² European terminals
G [☆]	1	OT terminal(inverter grounding)
H	3	(Expansion bolt, Gasket,Self-tapping bolt)*3
I	1	M5 inner hexagon bolt
J	4	Waterproof connector with RJ45 (COM/BMS/DRM/CT)
K	2	Battery connection terminals(positive*1, negative*1)
L	1	Manual
M	1	Quick Installation Guide
N [☆]	1	CT
O	1	Meter (optional)
P	1	Pocket WiFi
Q	1	CT 2 Kit (optional)

☆ Note: "C", "E", "F", "G" and "N" accessories are not contained in the accessory package of M version inverter, but contained in X1-Matebox.

4.3 Installation Precautions

The protection level of X1-Fit G4 series inverters is IP 65, so that the inverter can be installed outdoors.

Check the installation environment and pay attention to the following conditions when installing:

- Do not expose to strong light.
- Do not touch flammable building materials.
- Do not approach flammable and explosive gases or liquids (e.g. where chemicals are stored).
- Do not touch cold air directly.
- Do not approach TV antenna or cable.
- Do not place in areas above 3000 meters above sea level.
- Do not install in precipitation or high humidity, which may cause corrosion or damage Internal devices.
- Keep the system out of reach of children.

If the inverter is installed in a narrow area, be sure to reserve appropriate space for heat dissipation.







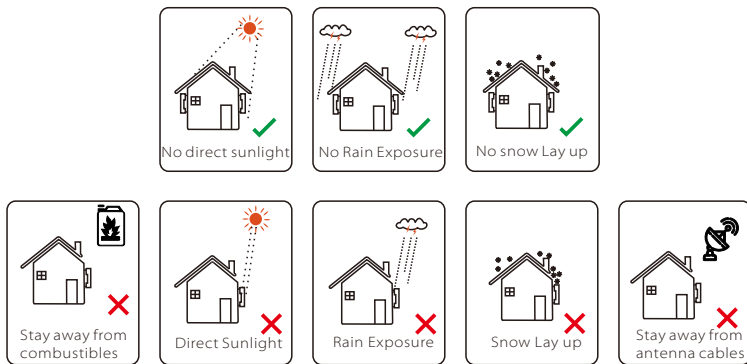









The ambient temperature of the installation site is -35°C~60°C.



The maximum angle of wall tilt $\pm 5^\circ$.







Avoid direct sunlight, rain and snow weather.



4.4 Tool preparation

Tool equipment				
Type	Name	Image	Name	Image
Machine Installation Tools	Hammer drill	Bit $\Phi 10$ 	Multimeter	DC Voltage Range ≥ 1100 V.DC 
	Torque screwdriver	Crosshead M5 	Socket wrench set (Hexagon)	
	OT terminals press clamp	0.5mm ² ~6mm ² 	Diagonal pliers	
	Utility knife		Multifunction terminal crimping tool (RJ45)	
	Diagonal pliers		Marker	
	Rubber hammer		Tape measure	
	Crimping Tool		Hexagon keys	
	Euro terminal crimping tool		Spirit level	
Individual Protection Tools	Dustproof Cover		Protective glasses	

Tool equipment				
Type	Name	Image	Name	Image
Individual Protection Tool	Safety gloves		Safety shoes	

Type	Name	Image	Requirement
Equipment Preparation	Breaker		Grid port and EPS port wiring section (4.5.2)
Cable Preparation	EPS end wire		Double Core Cables
	Grid end wire		Triple Core Cables
	Communication lines		Twisted pair with shield
	Battery Cable		Conventional wire
	PE Cable		Conventional wire

4.5 Installation Site Conditions

4.5.1 Installation Carrier Requirements

Do not install the inverter near flammable materials. Please install the inverter on a solid object that can withstand the weight requirements of the inverter and energy storage system. Please be careful not to install the inverter in the plasterboard wall or similar to the residential places with poor sound insulation, so as not to work with noise and interfere with the residents' life in the morning.

4.5.2 Installation Requirements

Install the inverter at a maximum back tilt of 5 degrees, the inverter can not be tilted forward, inverted, excessive back tilted or side tilted.

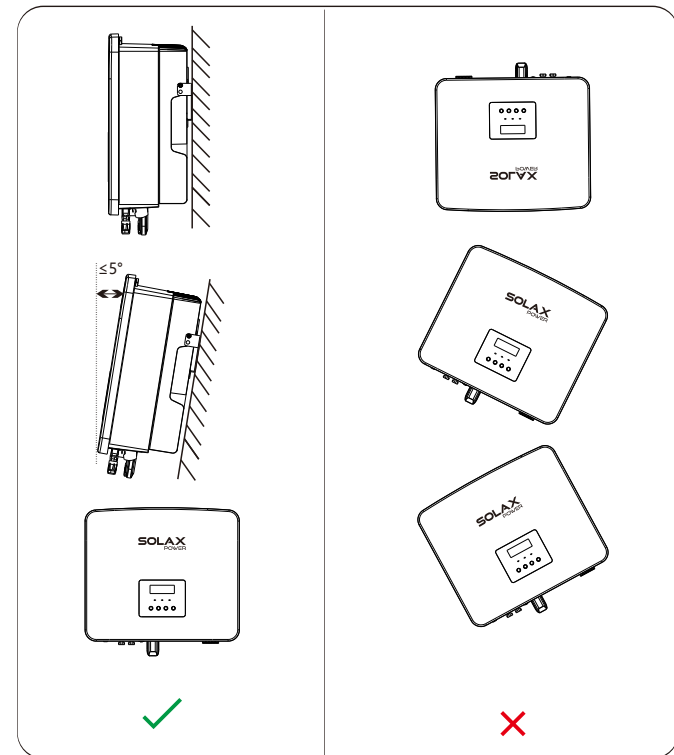

4.5.3 Installation Space Requirements

Reserve enough space when installing inverter (at least 300mm) for heat dissipation.

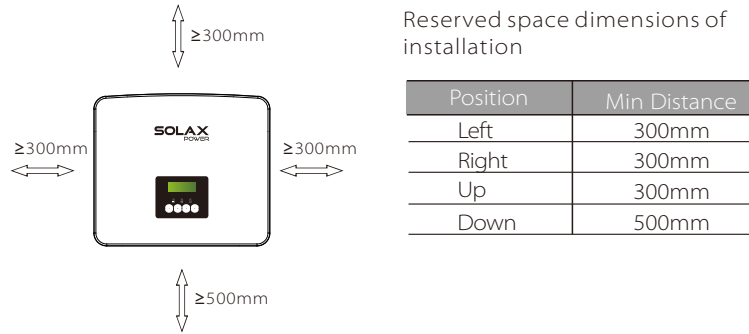

For multi-inverter installation scenarios, the inline installation method is recommended; when the space is insufficient, the recommended method of installation in the form of "products"; it is not recommended to install multiple inverters in stacks. If you choose stack installation, please refer to the installation separation distance below.

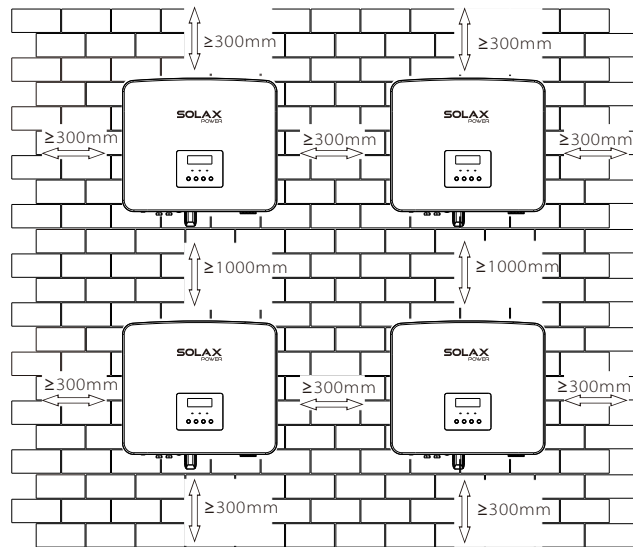

4.6 Mounting

➤ Preparation

Please prepare the following tools before installation.



Installation tools: screwdriver, wrench, $\Phi 10$ drill, rubber hammer, Outer hexagon wrench and Hexagon keys.

➤ Step 1: Fix the wall bracket to the wall.

First find the expansion screw and the wall bracket in the accessory bag, as shown below:



Expansion bolts, Gasket, Tapping screws

Bracket

- a) Use a marker to mark drilling holes of the bracket on the wall.
- b) Drill holes at marked spots with depth of 80mm.

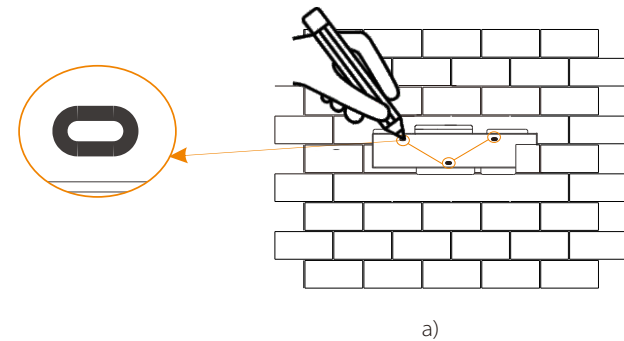

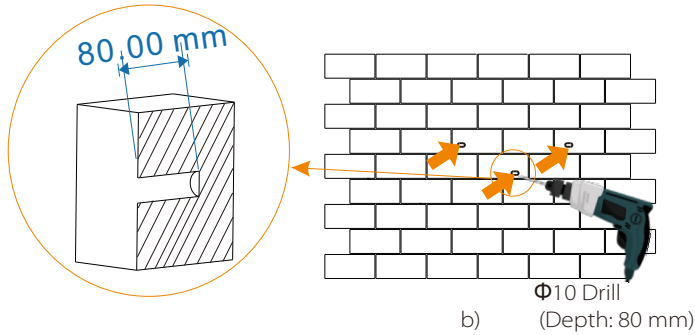

b)

➤ **Step 2: hang the inverter on the bracket.**

- c) Insert expansion bolt into the hole, use rubber hammer to knock the expansion screw bolt into the wall;
- d) The bracket is aligned with the screw uses the inner hexagonal wrench to screw the tapping screw until the expansion bolt "bang" is heard.

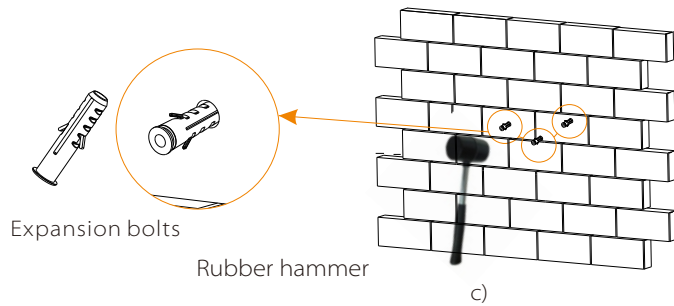

c)

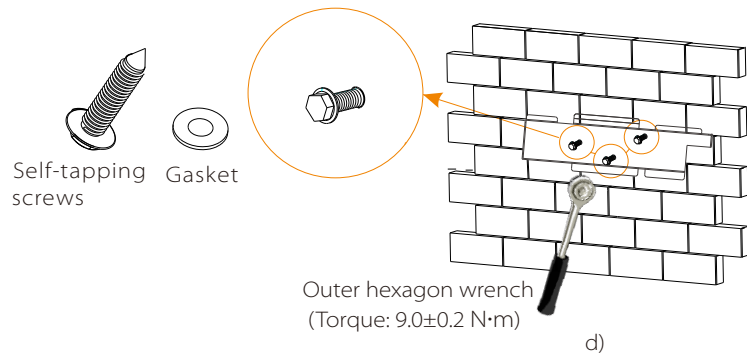

d)

➤ **Step 3: Tighten the inverter and bracket.**

- e) Hang the buckle on the inverter to the corresponding position of the backplane;
- f) Use the inner hexagonal wrench to tighten the inner hexagonal screw on the right side of the inverter.

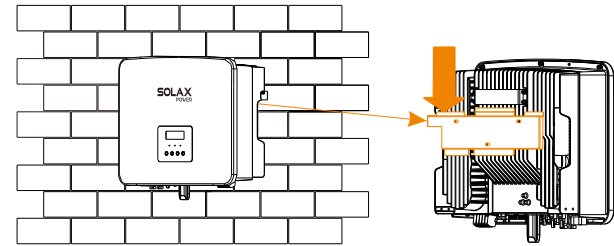

e)

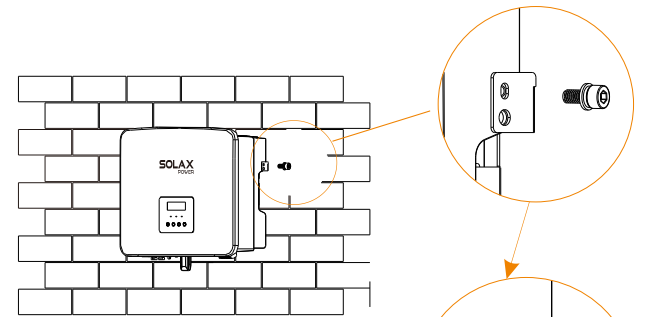

f)

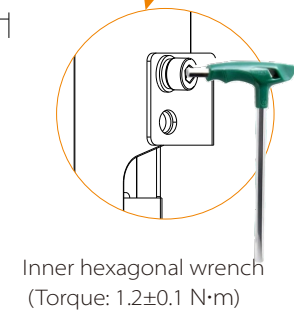

5 Electrical Connections

5.1 Grid Port and EPS Output Connection

X1-Fit G4 series inverter are single-phase inverter. Suitable for rated voltage 220/230/240V, frequency 50/60Hz. For more technical requirements, please consult the requirements of the local public grid.

➤ Grid port connection

Grid Cable and Micro-breaker recommended

Model	X1-Fit-3.7-W	X1-Fit-5.0-W	X1-Fit-6.0-W	X1-Fit-7.5-W
Cable (copper)	6-8mm ²	8-10mm ²	8-10mm ²	8-10mm ²
Micro-Breaker	40A	50A	50A	50A

Model	X1-Fit-3.7-M	X1-Fit-5.0-M	X1-Fit-6.0-M	X1-Fit-7.5-M
Cable (copper)	3-4mm ²	4-6mm ²	4-6mm ²	6-8mm ²
Micro-Breaker	25A	32A	32A	40A

EPS Cable and Micro-breaker recommended

Model	X1-Fit-3.7-W X1-Fit-3.7-M	X1-Fit-5.0-W X1-Fit-5.0-M	X1-Fit-6.0-W X1-Fit-6.0-M	X1-Fit-7.5-W X1-Fit-7.5-M
Cable (copper)	3-4mm ²	4-6mm ²	4-6mm ²	6-8mm ²
Micro-Breaker	25A	32A	32A	40A

The circuit breaker should be installed between the inverter and the mains, and the load should not be directly connected to the inverter.

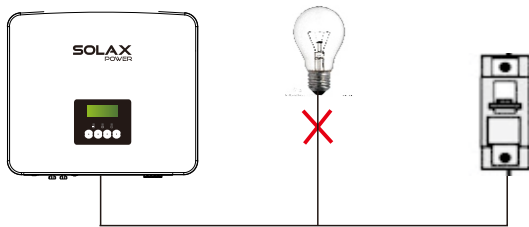

Figure: Wrong connection of load and inverter

5.2 EPS Block Diagram

X1-Fit G4 series inverter has an EPS function. When the grid is connected, the inverter outputs go through the Grid port, and when the grid is disconnected, the inverter outputs go through the EPS port. The EPS function can be connected to part of the load, and it can also be used to connect to all loads. Please refer to the following diagram for the wiring.

To be compatible with all loads, you will need an additional accessory. If you need a solution, please contact our sales.

➤ EPS wiring diagram

For different local wiring rules, please refer to the diagram below. Please select the appropriate wiring method according to local wiring rules.

Diagram A: Neutral line and PE line are separated from each other, and the common load is connected to the EPS port;(For most countries)

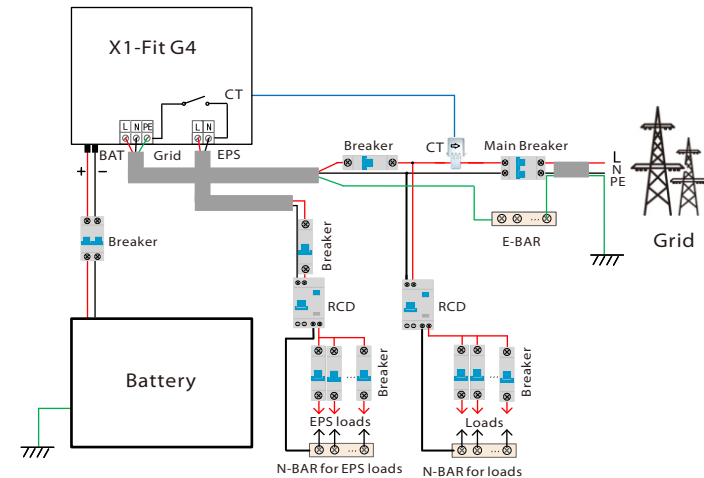

Diagram B: Neutral line and PE line are separated from each other, all loads connect to the EPS port;(For most countries)

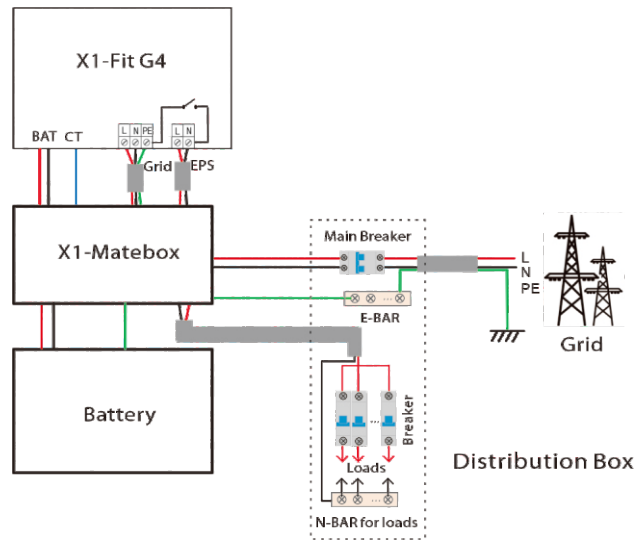

Diagram C: Neutral line and PE line are combined together, and the common load is connected to the EPS port;(Apply to Australia)

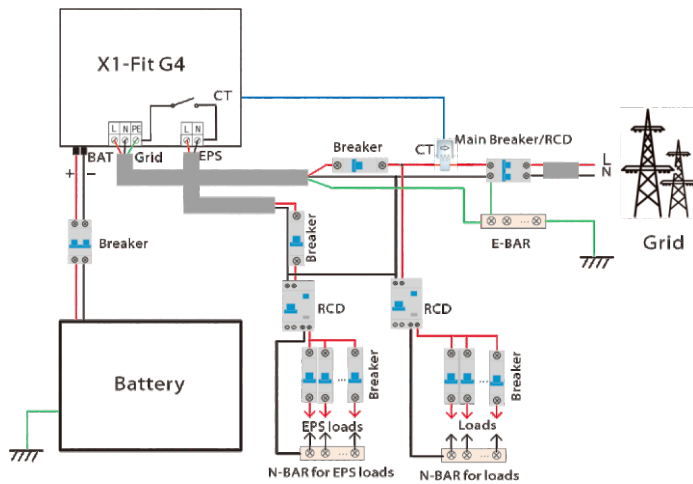
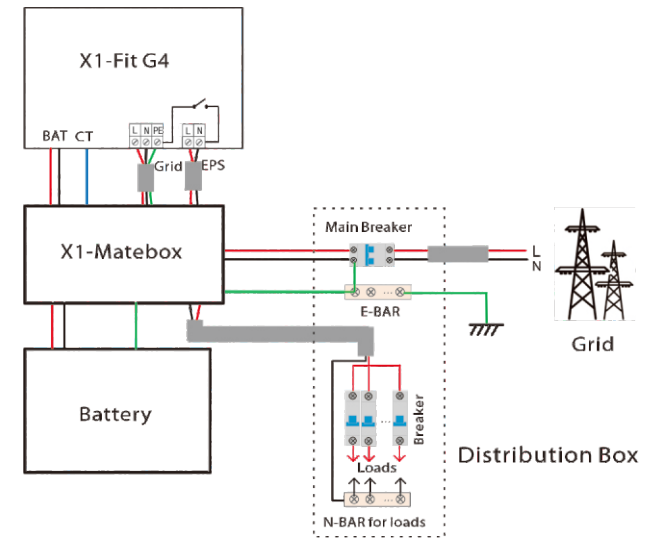

Diagram D: Neutral line and PE line are combined together, all loads connect to the EPS port;(Apply to Australia)



X1-Matebox is a convenient wiring and accessory that can realize EPS full load. For more information, please refer to X1-Matebox. If you need to buy X1-Matebox, please contact us.

In full load scheme **Diagram B** and **Diagram D**, set "Matebox" to "Enable" under Settings; The Australian customer must shorten the N lines of the Grid and the EPS in the X1-Matebox. If your local wiring method does not follow the above operation guide, especially the neutral wire, ground wire, RCD wire, please contact our company before operation.

➤ EPS load requirements

Warning!
 Ensure that the EPS load rated power is within the EPS rated output power range, otherwise, the inverter will report an "overload" warning.







When "overload" occurs, adjust the load power to make sure it is within the EPS rated output power range, and the inverter will automatically return to normal.

For non-linear loads, ensure that the inrush current power is within the EPS rated output power range. When the configuration current is less than the maximum DC input current, the capacity and voltage of lithium battery and lead acid battery will decrease linearly.

The following table shows some common loads for your reference.

Note: Please check with the manufacturer for high-power inductive loads.

Content	Power		Common equipment	Instance		
	Start	Rated		Equipment	Start	Rated
Resistive load	X 1	X 1	 Incandescent lamp	 100W Incandescent lamp	100VA (W)	100VA (W)
Inductive load	X 3~5	X 2	 Fan  Fridge	 150W Fridge	450 - 750VA (W)	300VA (W)

➤ Grid and EPS connection

- Connection requirements

Note: Check the grid voltage and compare the voltage range (see technical data).

Disconnect the circuit board from all power sources to prevent electric shock.

The Grid and the EPS ports of X1-Fit G4 M version inverter have been connected, for specific installation details, please refer to the X1-Matebox Quick Installation Guide. And the W version needs to be wired according to the following steps.

Step 1. Prepare a Grid cable (three-core wire) and an EPS cable (two-core wire), and then find the European terminal and waterproof cover in the accessory bag.

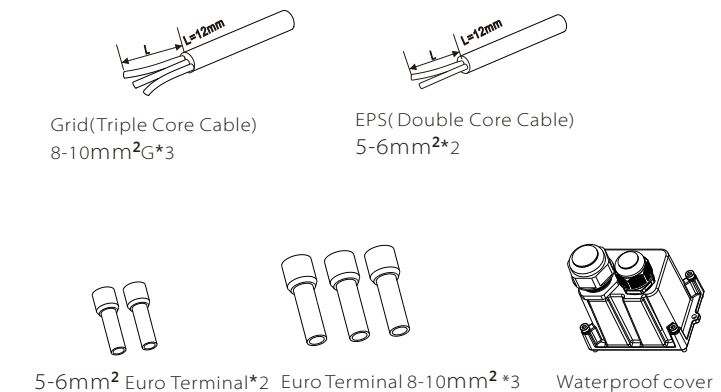

Step 2: The Grid and EPS cables go through the corresponding Grid and EPS ports of the waterproof cover.

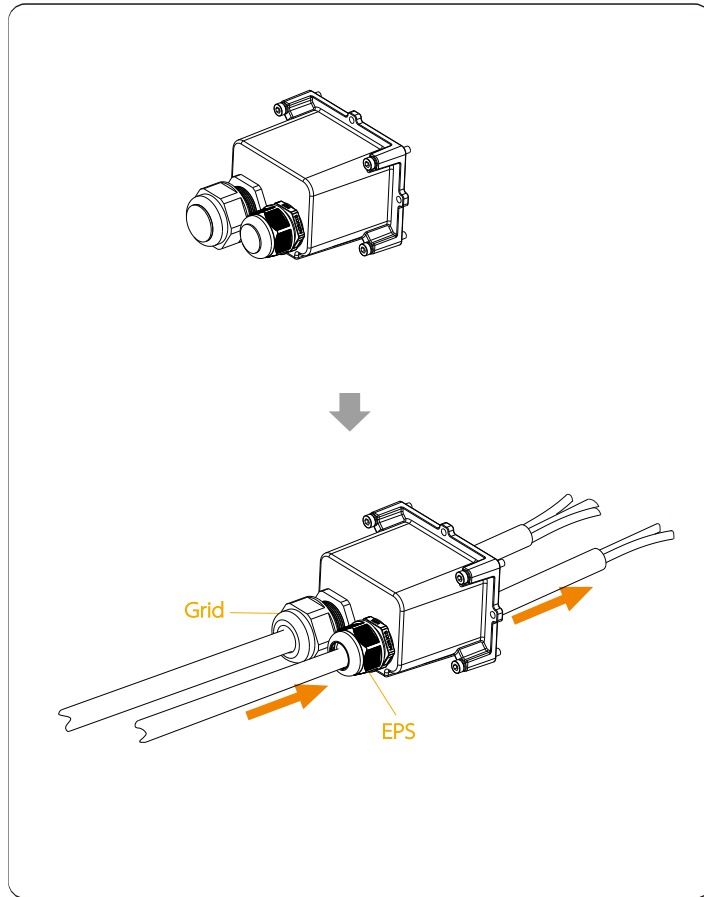

Step 3: Remove the 12mm insulation layer at the end of the wire. Insert the European-style terminals respectively, and make sure that the stripped ends are inserted into the European-style terminal, and finally use crimping pliers to press tightly.

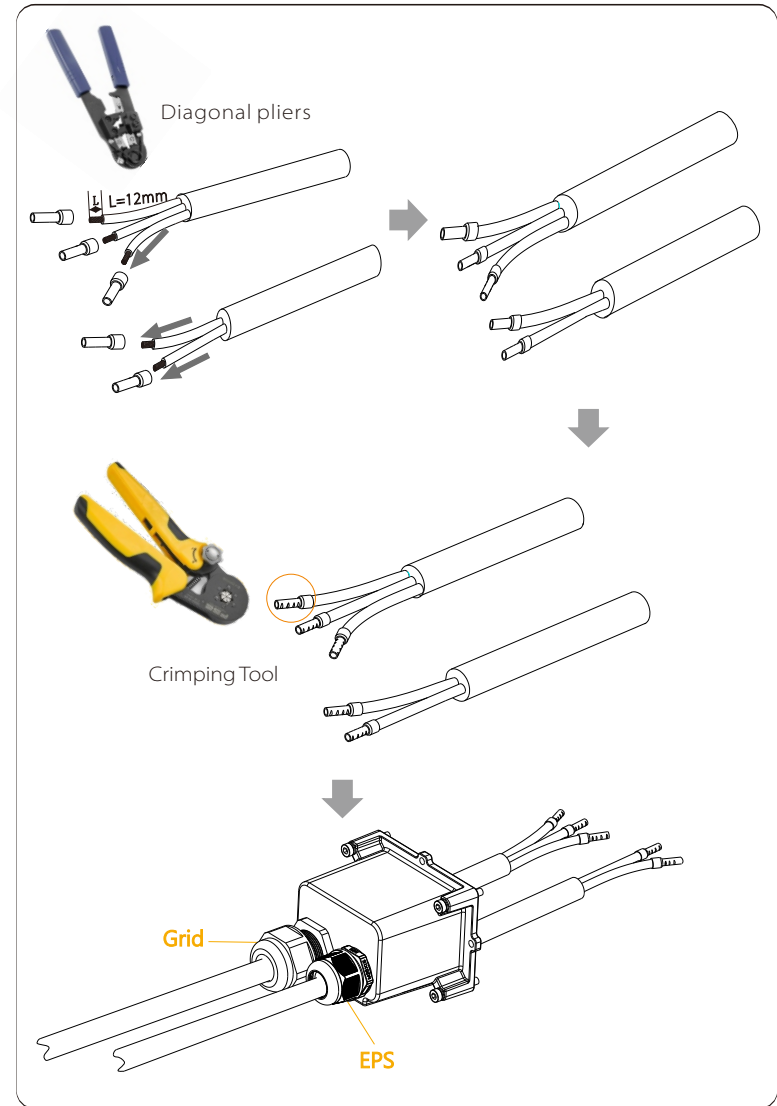

Step 4. Find the location of the AC interface on the inverter, insert the crimped terminals into the UW10 terminals L, N, and P according to the wire sequence, and use a flat-blade screwdriver to tighten the screws.

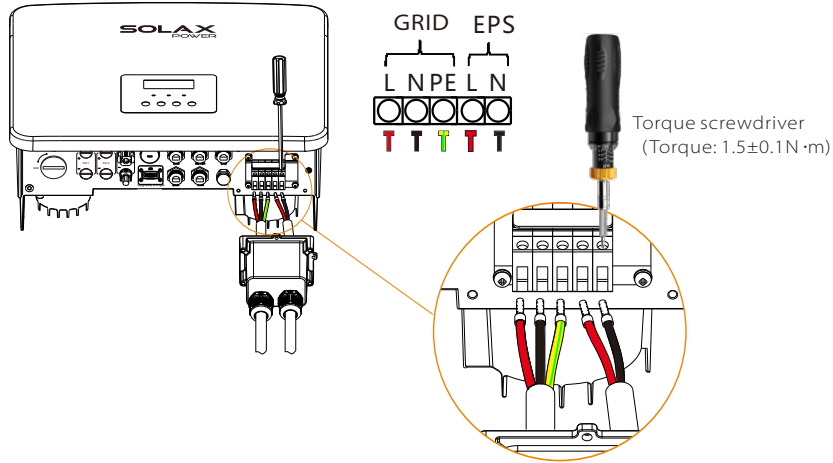

Step 5. Install the AC waterproof cover, and tighten the screws on the four sides of the waterproof cover with an Allen wrench.

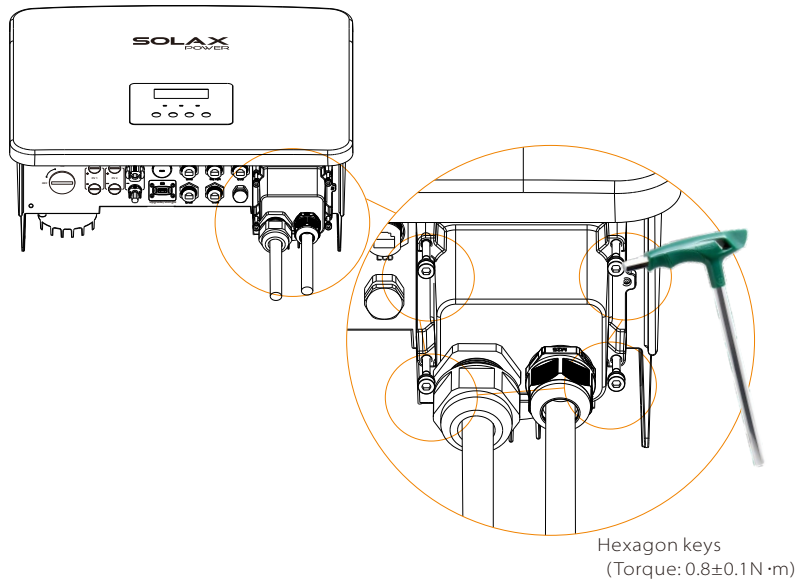

Step 6. Tighten the waterproof fastening head.

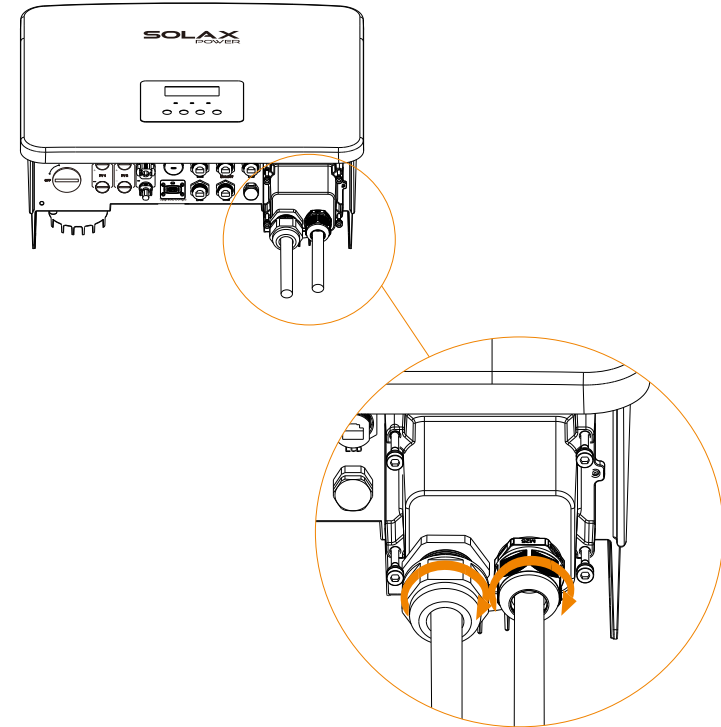

5.3 Battery Connection

➤ Connection requirements

X1-Fit G4 series inverter charge and discharge system can be equipped with high voltage lithium battery and lead acid battery.

Please note that the maximum voltage of the battery should not exceed 480 V, battery communication should be compatible with the X1-Fit G4 inverter.

➤ Battery Breaker

Before connecting the battery, a non-polar DC MCB must be installed to ensure safety.

Before maintenance, the inverter need to be safely disconnected.

Model	X1-Fit-3.7-W X1-Fit-3.7-M	X1-Fit-5.0-W X1-Fit-5.0-M	X1-Fit-6.0-W X1-Fit-6.0-M	X1-Fit-7.5-W X1-Fit-7.5-M
Voltage	Nominal voltage of DC breaker should be larger than maximum voltage of battery.			
Current[A]	32A			

➤ Battery connection diagram

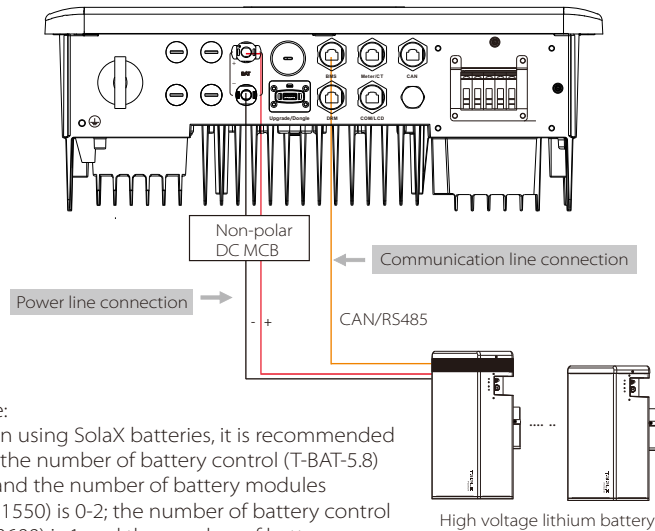

Note:
When using SolaX batteries, it is recommended that the number of battery control (T-BAT-5.8) is 1 and the number of battery modules (HV11550) is 0-2; the number of battery control (MC0600) is 1 and the number of battery modules (HV10230) is 1-4 pcs.

➤ Battery connection steps

Battery port connection line of the X1-Fit G4 M version inverter is on the X1-Matebox, just connect it. It is necessary to wire the W version according to the following steps.

Step 1. Prepare 8-10 mm² battery power line, find the DC plug (+), DC plug (-) in the accessory bag.

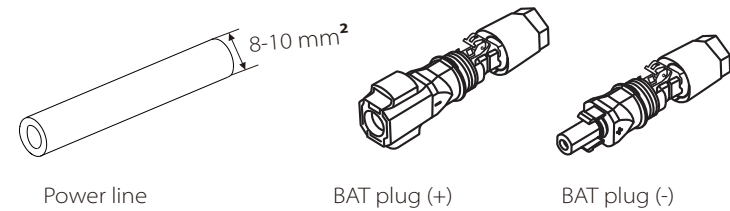

Step 2. Strip the insulation layer (length: 15mm) at one end of the power line.

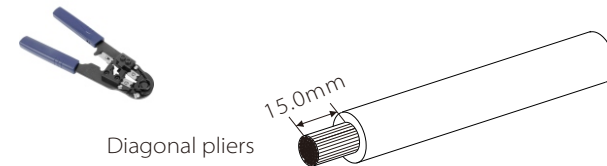

Step 3. Insert the stripped cables into the DC plug (-) and DC Plug (+) respectively.

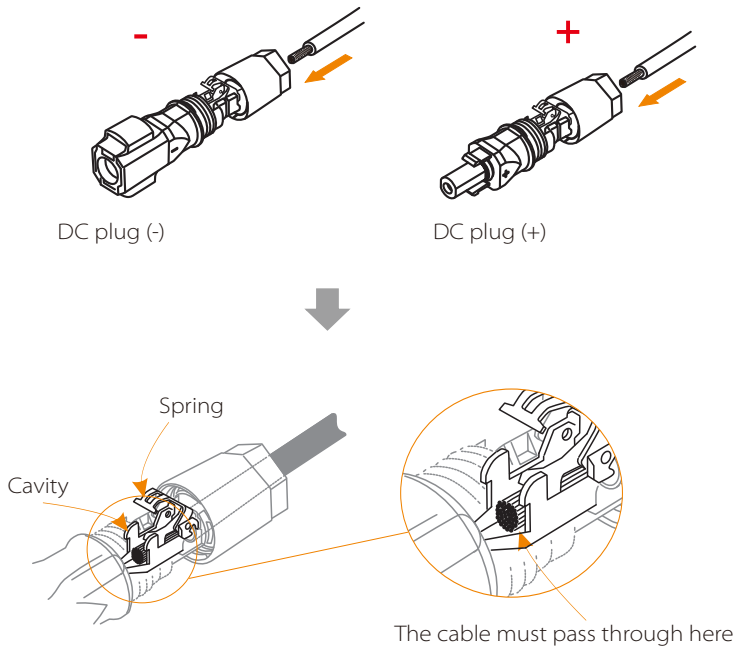

Step 4. Press down on the spring by hand, you can hear a click sound, then push the ends together, and tighten the screw joints.

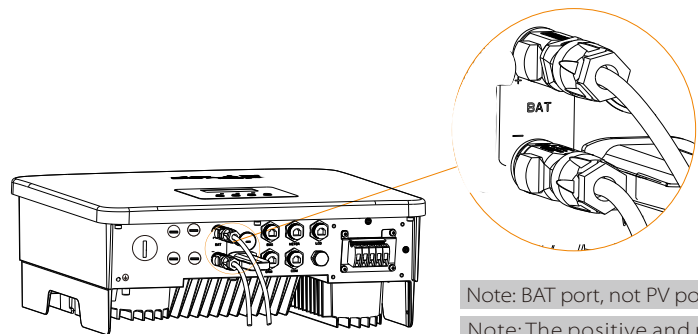
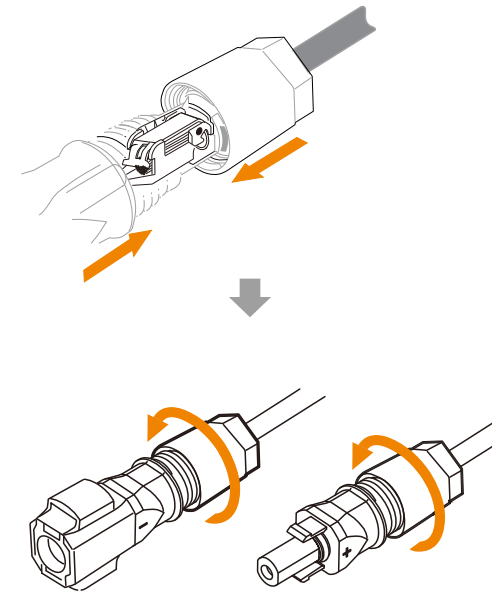
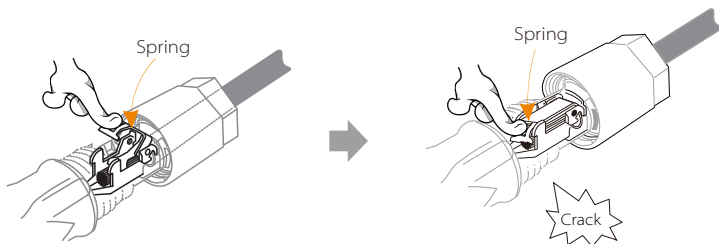

➤ Communication connection

BMS port definition

The communication interface between the inverter and the battery uses the waterproof connector with RJ45.

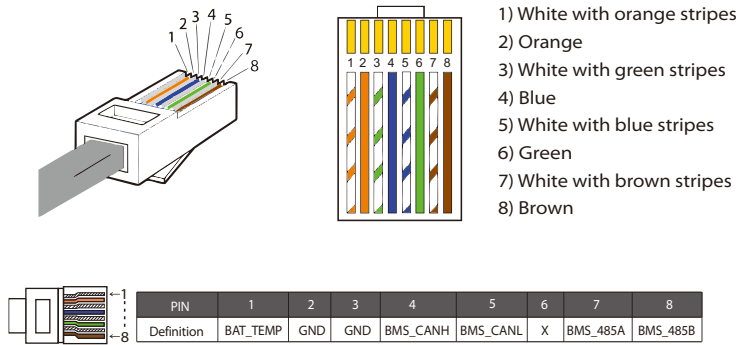

Note:
 After the BMS communication between the battery and the inverter is finished, the battery will work normally.

5.4 Communication Connection

5.4.1 Introduction to DRM communication

X1-Fit G4 series can support external control signal response, such as complying with AS4777 regulatory requirements.

➤ DRM requirements(AS4777 regulatory requirements)

Mode	Requirement
DRM0	Operation disconnect device
DRM1	Do not consume power
DRM2	Do not consume more than 50% of rated power
DRM3	Do not consume more than 75% of rated power AND Source reactive power if capable
DRM4	Increase power consumption (subject to constraints from other active DRMs)
DRM5	Do not generate power
DRM6	Do not generate more than 50% of rated power
DRM7	Do not generate more than 75% of rated power AND Sink reactive power if capable
DRM8	Increase power generation (subject to constraints from other active DRMs)

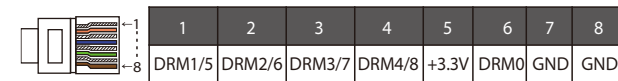

Note:
 For AS4777 DRM function, currently only PIN6 (DRM0) and PIN1 (DRM1/5) are functional, other PIN functions are under development.

5.4.2 Introduction to meter/CT Communication

X1-Fit G4 inverter should work with an electric meter or current sensor (CT for short) to monitor household electricity usage. The electricity meter or CT can transmit the relevant electricity data to the inverter or platform, which is convenient for users to read at anytime.

Users can choose electric meters or CTs according to demand.

Please note that the meter/CT brand required by SOLAX must be used.

Note!
 The meter or CT must be connected to the inverter, otherwise the inverter will shut down and alarm Solax "meter failure" alarm. Smart meters must be authorized by Solax, third party or other companies, Unauthorized meter may be incompatible with the inverter.
 Solax will not be responsible for the impact caused by the use of other appliances.

➤ Electric meter connection

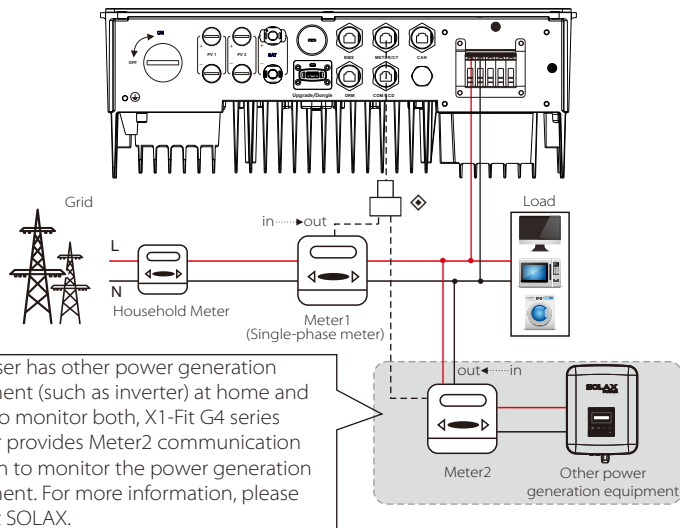

◆ Note: CT2 Kit, It is a convenient adapter accessory for X1-Fit G4 to monitor the grid-connected inverter. If you need it, please purchase it from the options.

➤ CT Connection

The current sensor measures the current on the live wire between the inverter and the public grid.

• CT connection diagram

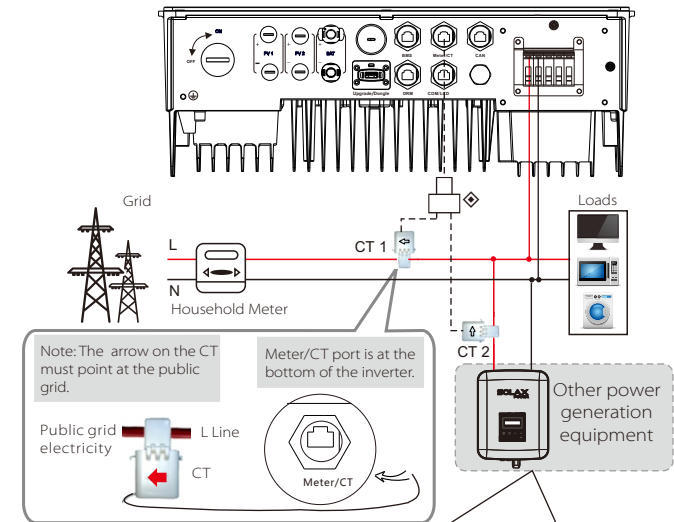

If the user has other power generation equipment (such as inverter) at home and wants to monitor both, X1-Fit G4 inverter provides CT2 communication function to monitor the power generation equipment. If you need this feature, please contact us SolaX for assistance.

◆ Note: CT2 Kit, It is a convenient adapter accessory for X1-Fit G4 to monitor the grid-connected inverter. If you need it, please purchase it from the options.

• LCD settings

To select CT, you need to enter Use setting, then enter CT/Meter Setting.

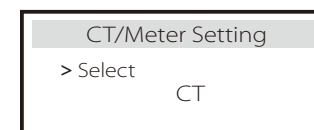

• Note for CT connection:

 **Note!**

- Do not place the CT on the N wire or ground wire.
- Do not put CT on the N line and L line at the same time.
- Do not place the CT on the side where the arrow points to the inverter.
- Do not place the CT on non-insulated wires.
- The cable length between CT and inverter should not exceed 100 meters.
- After CT is connected, prevent the CT clip from falling off. It is recommended to wrap the CT clip around in circles with insulating tape.

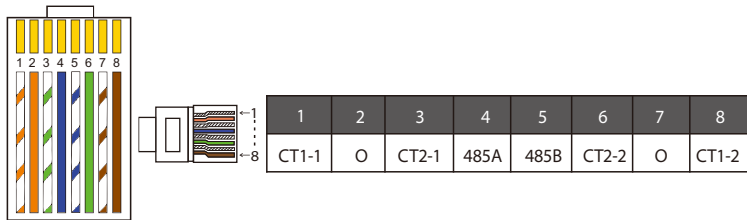

Note!
The electric meter and CT cannot be connected to one inverter at the same time. The meter cable is connected to pin terminals 4 and 5; the CT cable is connected to pin terminals 1 and 8; the reserved CT cable is connected to pin terminals 3 and 6.

➤ BMS communication cable

The BMS pin is defined as follows:

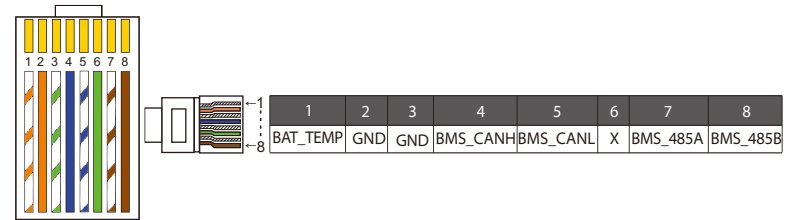

Note!
The BMS port on the inverter is the communication port for connecting the battery. The communication port on the lithium battery must be consistent with the definition of pins 4, 5, 7, and 8 above;

➤ DRM communication cable

The DRM pin is defined as follows:

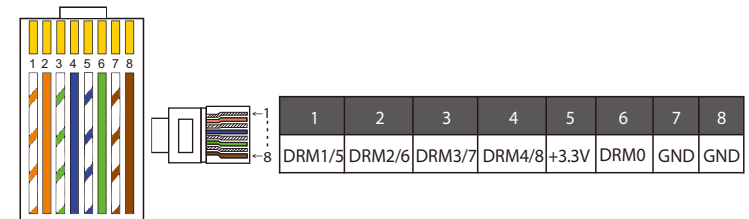

Note!
For AS4777 DRM function, currently only PIN6 (DRM0) and PIN1 (DRM1/5) are functional, other PIN functions are under development.

5.4.3 Parallel Connection

X1-Fit G4 Series Inverter provides the parallel connection function which should make 2 inverters maximumly connected in one system. In this system, one inverter will be set as the "Master inverter" which will control every other inverters. and communicate with the "Master Inverter", and all other slave inverters are connected to the "Master Inverter" in parallel via CAN cable.

➤ System Diagram

System diagram applied to electric meter:

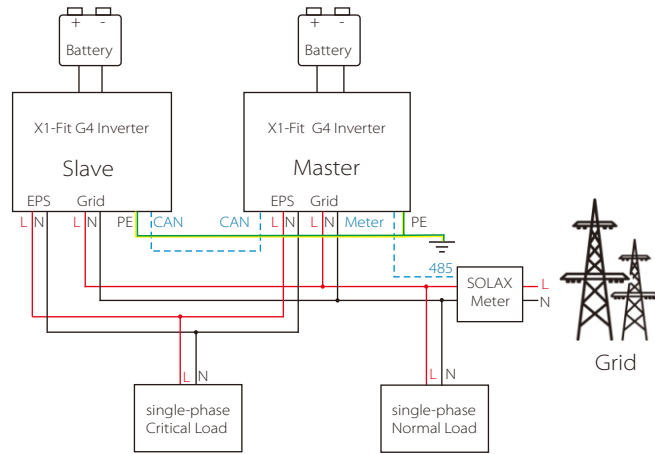

System diagram applied to electric CT:

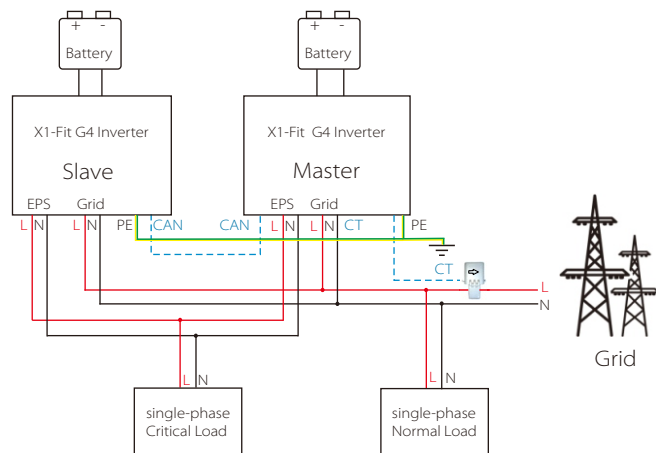

➤ Work Modes in parallel system

There are three work modes in parallel system, and your acknowledge of different inverter's work modes will help you understand parallel system better, therefore please read it carefully before operating.

Free mode	Only if no one inverter is set as a "Master", 2 inverter are in free mode in the system.
Master mode	When one inverter is set as a "Master", this inverter enters master mode. Master mode can be changed to free mode.
Slave mode	Once one inverter is set as a "Master", another inverter will enter slave mode automatically. slave mode cannot be changed from other modes by LCD setting.

➤ Wiring Operation and LCD Setting



Note: Before operation, please make sure that the inverter meets the following three conditions,

1. The software version of all inverters is the same;
 2. The power range of all inverter models is the same;
 3. The type and quantity of batteries connected to all inverters are the same;
- Otherwise, this function cannot be used.

Step1: Connect all inverters' communication together by connecting CAT7 network cables between CAN ports.

- Insert one side of CAT7 cable into the first inverter's CAN port and the other side into the next inverter's CAN port.
- Insert one side of CAT5 cable Meter, and the other side into the Meter port the master inverter.

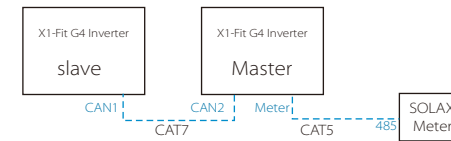

➤ CAN PIN Definition

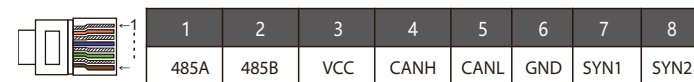

Step 2: Turn on the power of the entire system, find the inverter connected to the meter, enter the setting page of the inverter LCD screen, click on the parallel settings, and select "Master control";

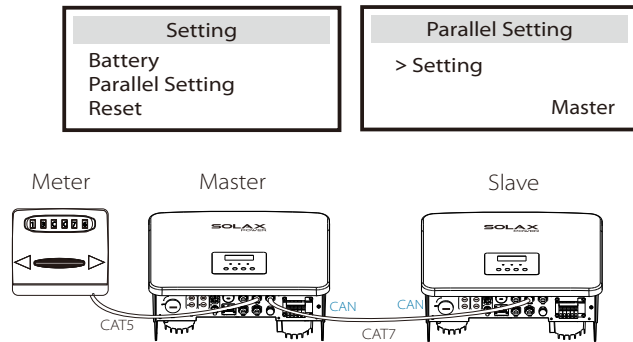

➤ How to Remove parallel system

If one inverter wants to exit from this parallel system, please do the steps as below:

- step1: Disconnect all the network cables on the CAN port.
- step2: Enter setting page and click parallel setting, and choose "Free".

Note!

- If a slave inverter is set to "Free" mode but not disconnect the network cable, this inverter will return to "slave" mode automatically.
- If a slave inverter is disconnected with other inverter but not be set to "Free" mode, this inverter will stop working and report parallel fault.

➤ LCD display

Main display:

Once inverter enters parallel system, the "today yield" will be replaced by "Inverter Class", and parallel relevant fault has a higher priority than other faults and will be showed firstly on main display.

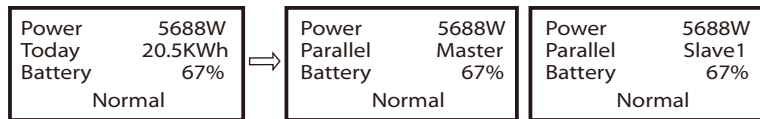

Status display:

User can obtain all the status data from master inverter. System power and individual slave inverter power can be obtain in status display of master inverter.

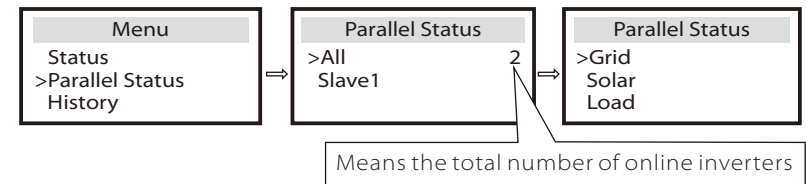

➤ Parallel Control Function

Master inverter has an absolute lead in the parallel system to control all slave inverter's energy management and dispatch control. Once master inverter has some error and stop working, all slave inverter will be stop simultaneously. But master inverter is independent of all slave inverter to work and will not be affected by slave inverter's fault.

Overall system will be running according to master inverter's setting parameters, and most setting parameters of slave inverter will be kept but not be cancelled.

Once slave inverter exit from system and be running as an independent unit, its all setting will be re-excuted.

The rest of this section covers several important parallel control functions, and the next page table shows which LCD options are controlled by master inverter and which can work independently.

Off mode setting:

Off mode can only be set by master inverter (long press ESC button on LCD).

Safety setting:

System safety protection is cancelled by master inverter's safety. slave inverter protection mechanism will only be triggered by master inverter's instructions.

Self use setting:

If system is running as self-use mode, please note the Feed-in Power Limit set of master inverter is for the overall system and the corresponding set of slave inverter is invalid.

Power Factor setting:

All sets about power factor are all for the overall system and the corresponding sets of slave inverter are invalid.

Remote control setting:

The remote demand instructions received by master inverter will be interpreted as the demand instructions to overall system.

5.4.4 COM Communication

COM communication interface is mainly provided for customization the second step of development use. The inverter supports the control of external equipment or external equipment control through communication. For example, the inverter adjusts the working mode of the heat pump and so on.

➤ Application occasion

COM is a standard communication interface, through which the monitoring data of the inverter can be directly obtained. Also, external communication devices can be connected to carry out the secondary development of the inverter. For specific technical docking, please contact SolaX.

- External communication equipment controls the inverter:

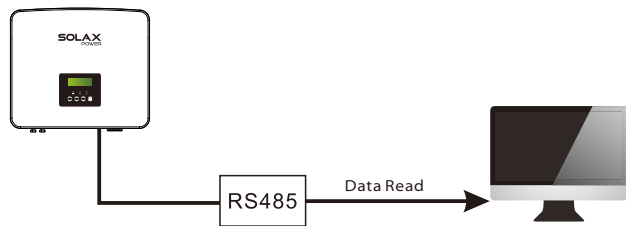

- Inverter communication control external equipment:

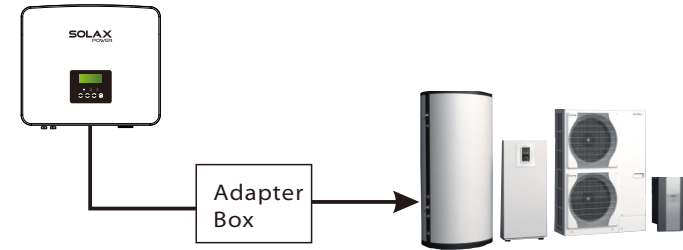

➤ COM PIN Definition

1	2	3	4	5	6	7	8
Drycontact_A(in)	Drycontact_B(in)	+12V	485A	485B	GND	Drycontact_A(out)	Drycontact_B(out)

Note!

Customers can communicate or control the inverter and external devices through the COM interface. Professional users can use pins 4 and 5 to realize data acquisition and external control functions. The communication protocol is Modbus RTU. For details, please contact SolaX. If the user wants to use the inverter dry contact to control external equipment (such as a heat pump), it can be used with SolaX's Adapter Box. For details, please refer to the Quick Installation Manual of the Adapter Box.

5.4.5 Communication Connection Steps

Step 1. Prepare a communication cable, and then find the communication adapter in the accessory bag.

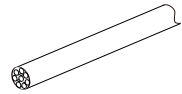

Communication cable

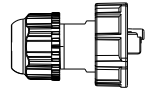

Waterproof connector with RJ 45

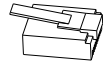

RJ 45 terminal

Step 2 Insert the communication cable through the communication adapter, and peel off the outer insulation layer of 15 mm.

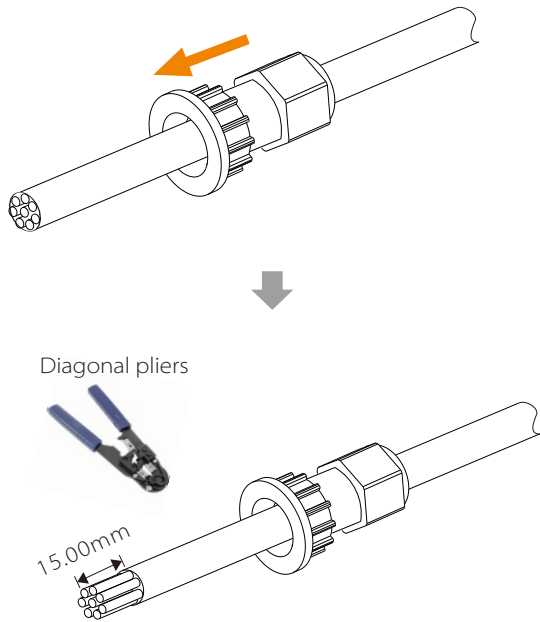

Diagonal pliers

15.00mm

Step 3. Insert the prepared communication cables into the RJ45 terminals in sequence, and then use network cable crimping pliers to press them tightly.



- 1) White with orange stripes
- 2) Orange
- 3) White with green stripes
- 4) Blue
- 5) White with blue stripes
- 6) Green
- 7) White with brown stripes
- 8) Brown

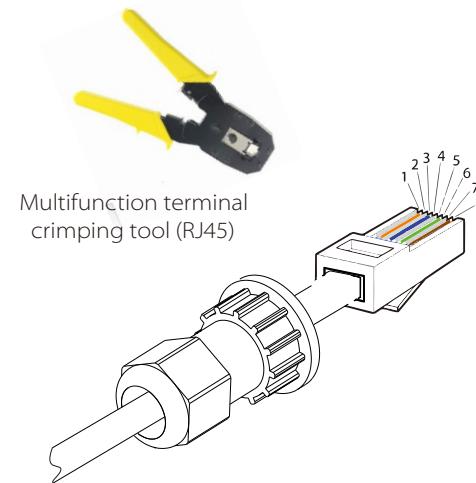

Multifunction terminal crimping tool (RJ45)

> **METER/CT**

METER/CT pin is defined as follow:

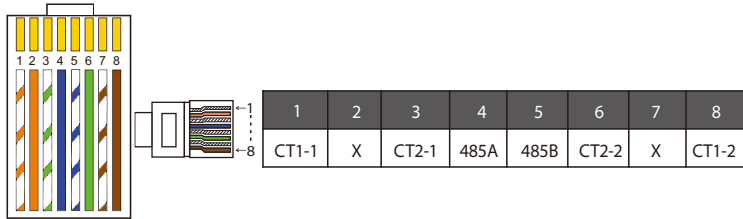

Note!

Only one of the Meter and CT connections can be selected. Meter cable goes to pin terminal 4 and 5; CT cable goes to pin terminal 1 and 8; CT2 cable goes to pin terminal 3 and 6.

1) Users can customize the length of the CT communication cable. The accessory package provides 1*RJ45 and 1*waterproof connector with RJ45 terminals.

When the CT cable is completed, connect the A terminal to the "CT/METER" port of the inverter and tighten the waterproof screw, and connect the B terminal to the RJ45 coupler

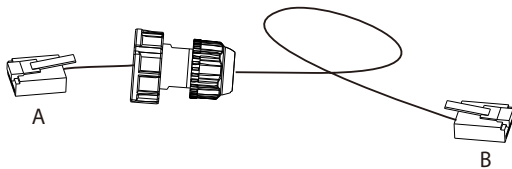

2) One side of the finished cable, Waterproof connector with RJ45 is inserted into the inverter, and one side of the RJ45 terminal is inserted into the CT connection.

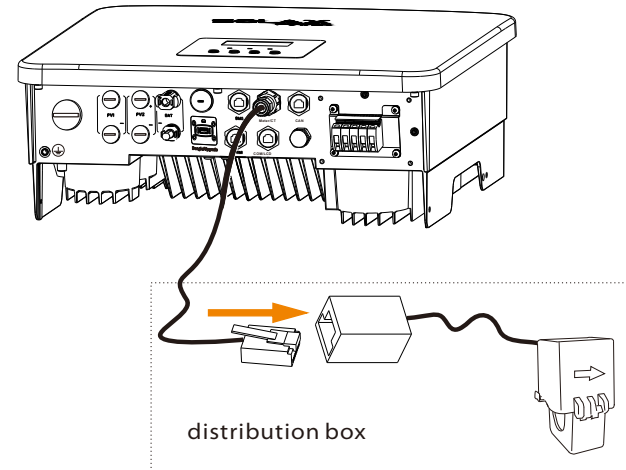

Note!

When installing, pay attention to water resistance. All the connected parts of CT must be put into the distribution cabinet.

Step 4. Tighten the completed Meter/CT/BMS communication line and tighten the waterproof plug.

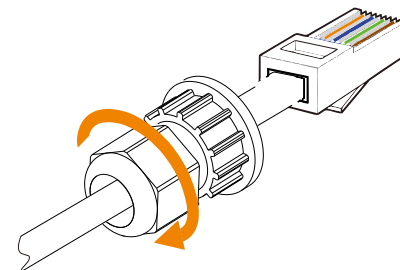

Step 5: Finally, find the corresponding COM, Meter, CT, DRM, CAN, LCD ports on the inverter and insert the communication cable into the corresponding ports.

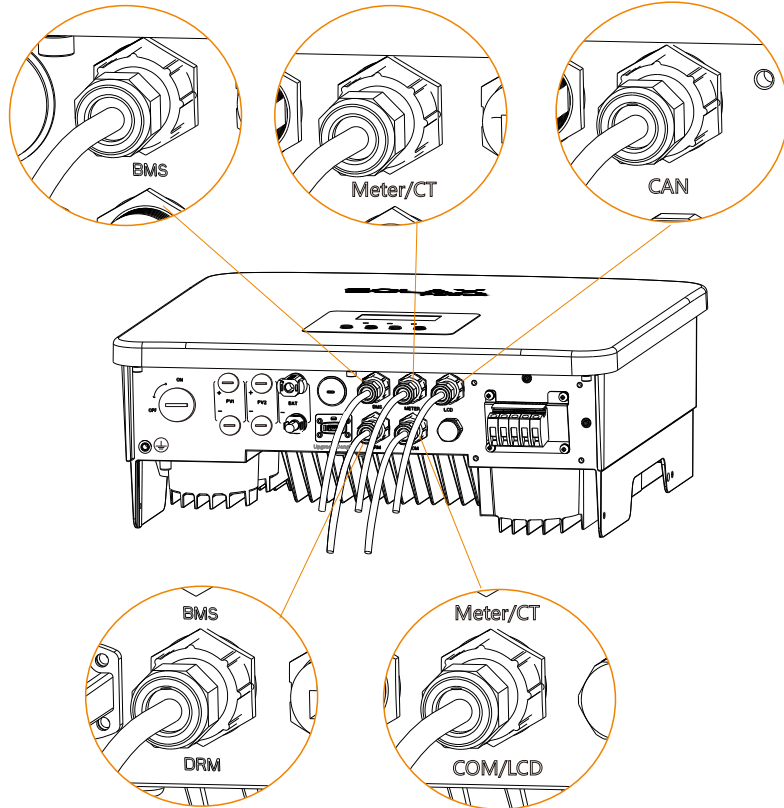

5.5 Grounding Connection (mandatory)

The user must make two ground connections: one shell grounding, and one equipotential grounding. This prevents electric shock.

The ground wire port of X1-Fit G4 M version inverter has been connected, and the W version needs to be wired according to the following steps.

➤ Ground connection steps

Step 1. Prepare a one-core cable (3-4 mm²), and then find the ground terminal in the accessories.



Step 2. Strip the grounding cable insulation (length "L2"), insert the stripped cable into the ring terminal, and then clamp it.

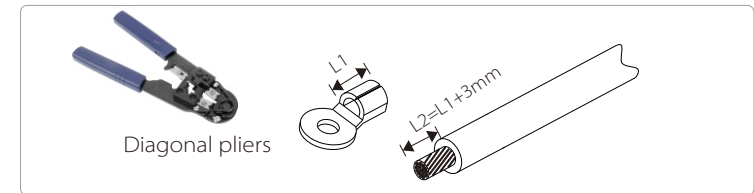

Step 3. Insert the stripped cable into OT terminal and tighten the terminal with a terminal crimping tool.

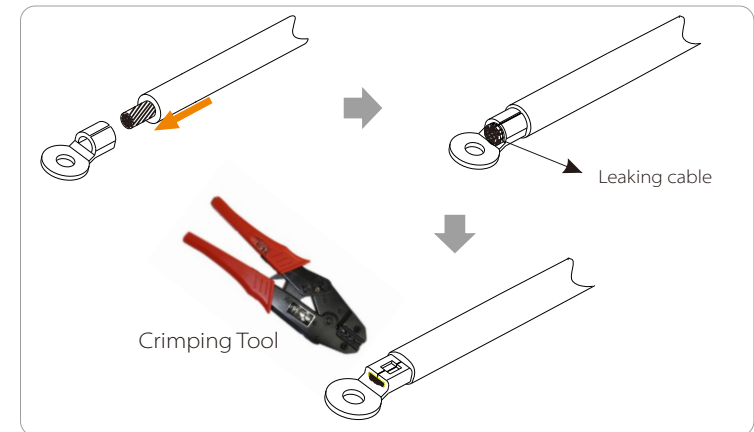

Step 4. Find the ground connection port on the inverter, and screw the ground wire on the inverter with an M5 Hexagon keys.

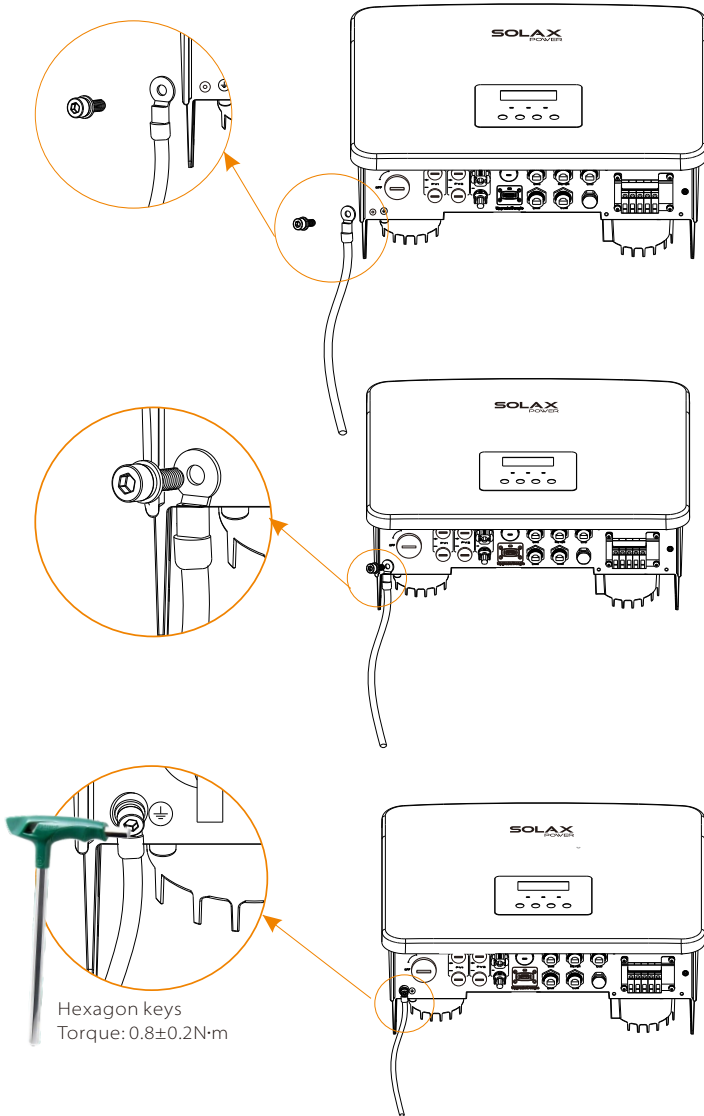

5.6 Monitoring Connection (Accessories)

The inverter provides a DONGLE port, which can transmit data of the inverter to the monitoring website via Pocket WiFi Plus, Pocket 4G, and Pocket LAN. (If necessary, purchase products from Solax)

➤ WiFi connection

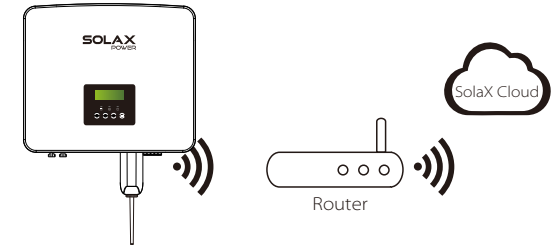

➤ Wireless monitoring accessories connection steps

Step 1. First find the DONGLE port of the inverter.

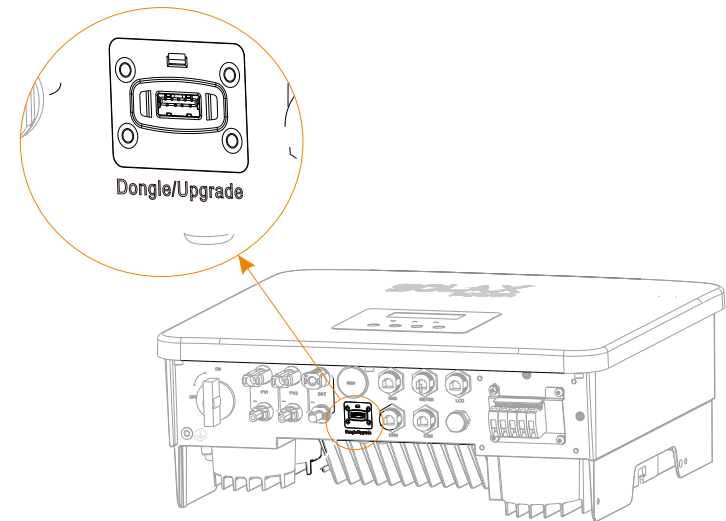

Step 2. Plug Pocket WiFi into the DONGLE port.

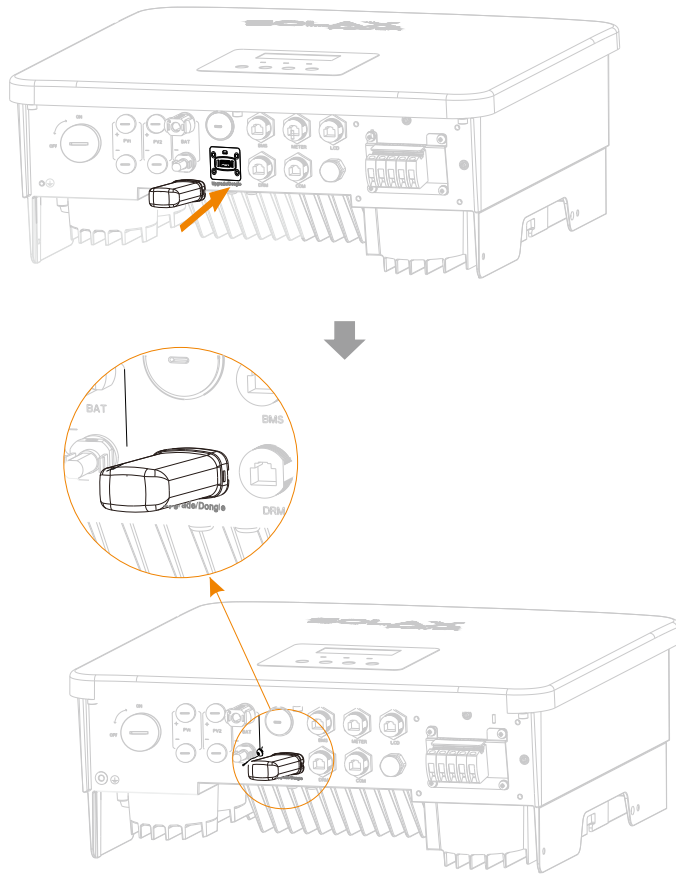

Please check the Pocket wifi user manual/Pocket LAN user manual /4G user manual for more details.

5.7 Check All Below Steps Before Starting Inverter

➤ After the inverter is checked, then conduct the following steps

- ❶ Make sure that the inverter is fixed on the wall.
- ❷ Ensure that all ground wires are grounded.
- ❸ Confirm that all DC lines and AC lines are connected.
- ❹ Make sure the CT is connected.
- ❺ Make sure the battery is well connected.
- ❻ Turn on the Load switch and EPS switch.
- ❼ Turn on the battery switch.

Long press the "Enter" key for 5 seconds to exit the Off mode.
(The mode is factory defaulted as Off Mode)

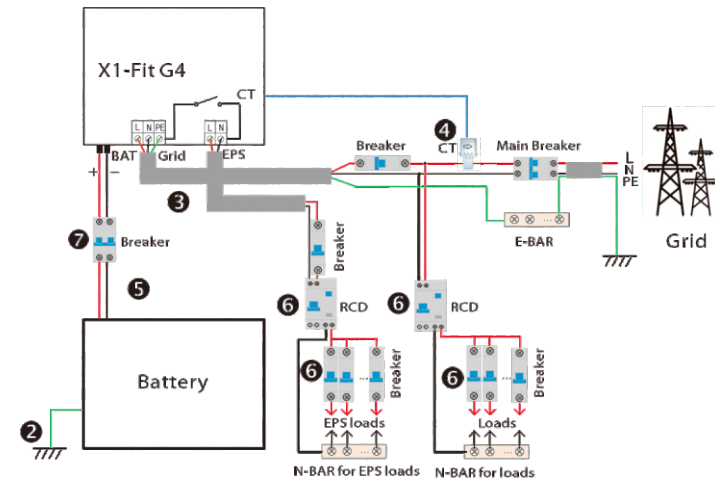

5.8 Inverter Operation

➤ Before operation, check the inverter according to the following steps

- Check that the inverter is well fixed on the wall.
- Ensure that all ground wires are well tightened.
- Ensure that all AC circuit breakers are disconnected.
- Ensure that all ground wires are well tightened.
- The AC output terminal is correctly connected to the mains.

➤ Start the inverter

- Steps to start the inverter
 - Turn on the AC switch between the X1-Fit G4 and the power grid.
- Check the status of the LED and LCD screen, the LED is green, and the LCD screen displays the main interface.
- If the LED is not green, please check the following:
 - All connections are correct.
 - All external disconnect switches are closed.

Step1. Check the status of indicators and LCD screen. The left indicator should be blue and the indicator screen should display the main interface.

Step2. There is a setting guide on the LCD screen if it is the first time to start up, please follow it. For specific setting, please refer to section 7 (Setting).

Step3. Set WiFi according to wifi user manual.

Step4. Operate "Self Test". (applies to Italy only)

If it is the first time to boot, please follow the prompts to enter the setting interface.



Warning!

The input terminal of the inverter can be opened only when all the installation work of the inverter has been completed. All electrical connections must be performed by professionals in accordance with local regulations.



Note!

If it is the first time to operate the inverter, the system will automatically display setup guide. Please follow the setup guide to complete the basic inverter settings.

6 Firmware Upgrading

➤ Upgrade notes

Please read the following precautions before upgrading.



Warning!

- In order to upgrade the firmware smoothly, if the DSP and ARM firmware need to be upgraded, please note that ARM firmware must be upgraded first, then DSP firmware!
-Please make sure that the category format is correct, do not modify the firmware file name, Otherwise, the inverter may not work!



Warning!

- For X1-Fit G4, please ensure that the battery SOC is greater than 20% or the battery input voltage is greater than 90V. Otherwise, it may cause serious failure during the upgrade process!



Caution!

- If the ARM firmware upgrade fails or stops, please do not unplug the U disk power off the inverter and restart it, Then repeat the upgrade steps.



Caution!

- If the DSP firmware upgrade fails or stops, please check whether the power is off. If it is normal, plug in the U disk again and repeat the upgrade.

➤ Upgrade preparation

1) Please check the inverter version and prepare a U disk (USB 2.0/3.0) and personal computer before upgrading.



Caution!

-Please make sure that the size of the U disk is smaller than 32G, and the format is fat16 or fat 32.

2) Please contact our service support through service@solaxpower.com to obtain the firmware, and store the firmware in the U disk according to the following path.

Update:

For ARM file: "update \ARM\618.00361.00_Fit_X1G4_ARM_V1.01_0710.usb";

For DSP file: "update \DSP\618.00360.00_Fit_X1G4_DSP_V1.01_0710.usb";

➤ Upgrade steps

Step 1. Please save the "Upgrade" firmware in your U disk first, and press the "Enter" button on the inverter screen for 5 seconds to enter the OFF mode.

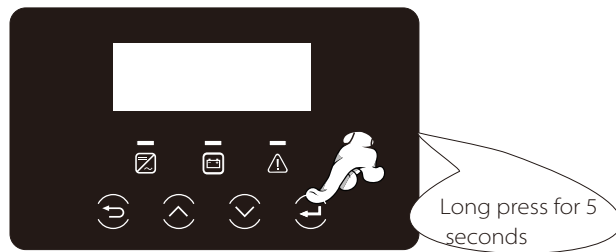

Step 2. Find the "Upgrade" port of the inverter, unplug the monitoring module (Pocket WiFi/ Pocket LAN/Pocket 4G) by hand, and insert the USB flash drive.

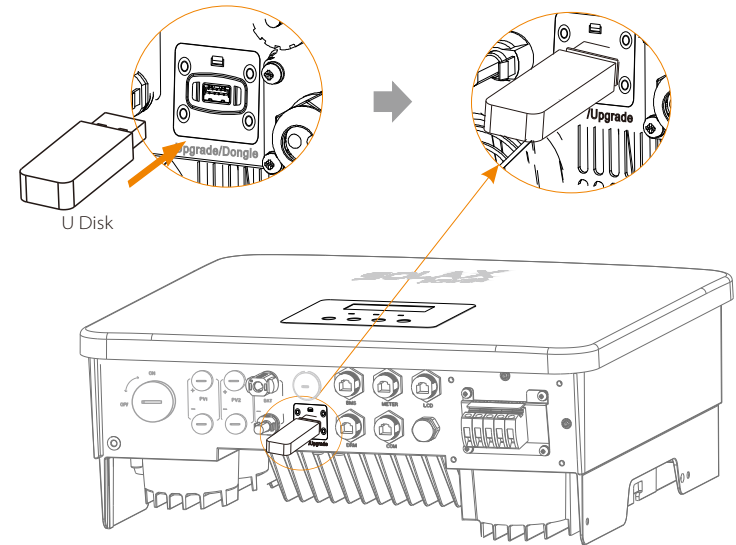
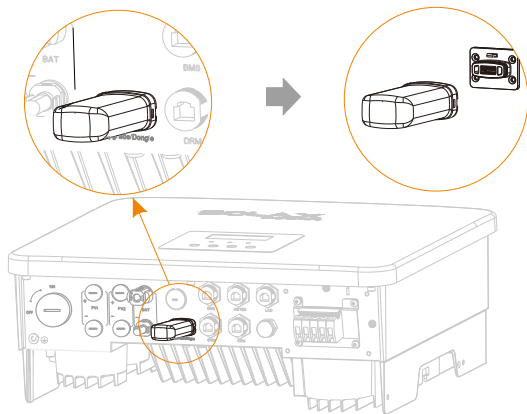

Step 3. LCD operation, enter the upgrade interface "update", as shown below(a): Please press the up and down keys to select ARM, then press down to set "OK", press the enter key to enter the software version interface;

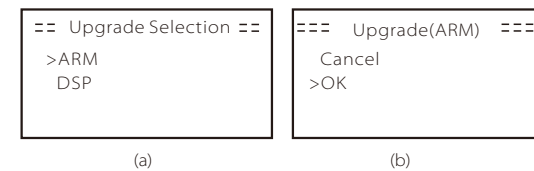

Step 4. Please confirm the new firmware version again and select the firmware to upgrade. The upgrade takes about 20 seconds.

(d) When it is completed, the LCD screen returns to the "Update" page.

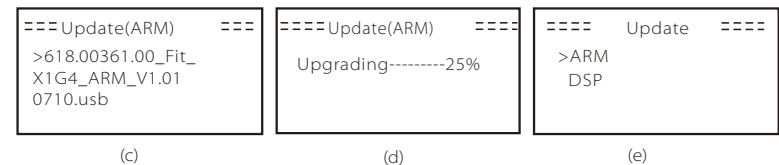

Step 5. For DSP: Please wait for 10 seconds. When "Update" page shown as below, press down to select "DSP" and then press Enter. Please confirm the firmware version again and press Enter to upgrade. The upgrade takes about 2 minutes.

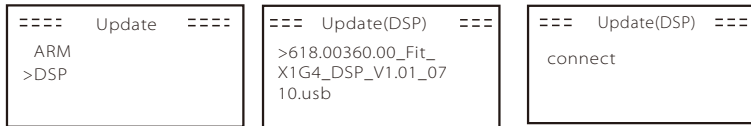

(f)

(g)

(h)



(i)

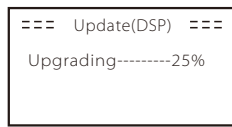

(j)

Step 6. After the upgrade is completed, the LCD screen displays "Upgrade Successful".

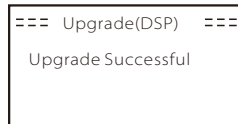

(k)

Step 7. Plug off the U disk, press "Esc" to return to the main interface, and long press the enter key to exit the mode.

Caution!

- Please strictly follow each step from step 1-6, don't miss it.
- Please confirm the ARM/DSP firmware version on the USB flash drive.

Tip: If the display screen is stuck on "X1-Fit G4" after the upgrade, please the inverter will restart and return to normal. If not, please contact our service @solaxpower.com for help.

7 Setting

7.1 Control Panel

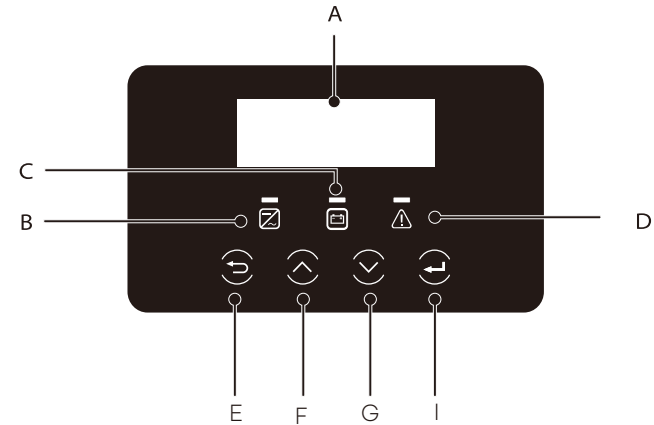

Object	Name	Description
A	LCD Screen	Display inverter information on the LCD display.
B	LED Indicator light	Blue light: The inverter is in normal state or EPS mode. Blue flashing: The inverter is in the waiting, checking state or the system switch is off. Off: The inverter is in a fault state.
C		Green: The battery communication is normal but the battery MCB is disconnected, and the battery communication is normal and working normally. Green flashing: The battery communication is normal and in an idle state. Off: The battery does not communicate with the inverter.
D		Red light on: The inverter is in a fault state. Off: The inverter has no error.
E	Key Function	ESC button: Return from the current interface or function.
F		Up button: Move the cursor to the upper part or increase the value.
G		Down button: Move the cursor down or decrease the value.
H		Enter button: Confirm selection.

7.2 Menu Structure

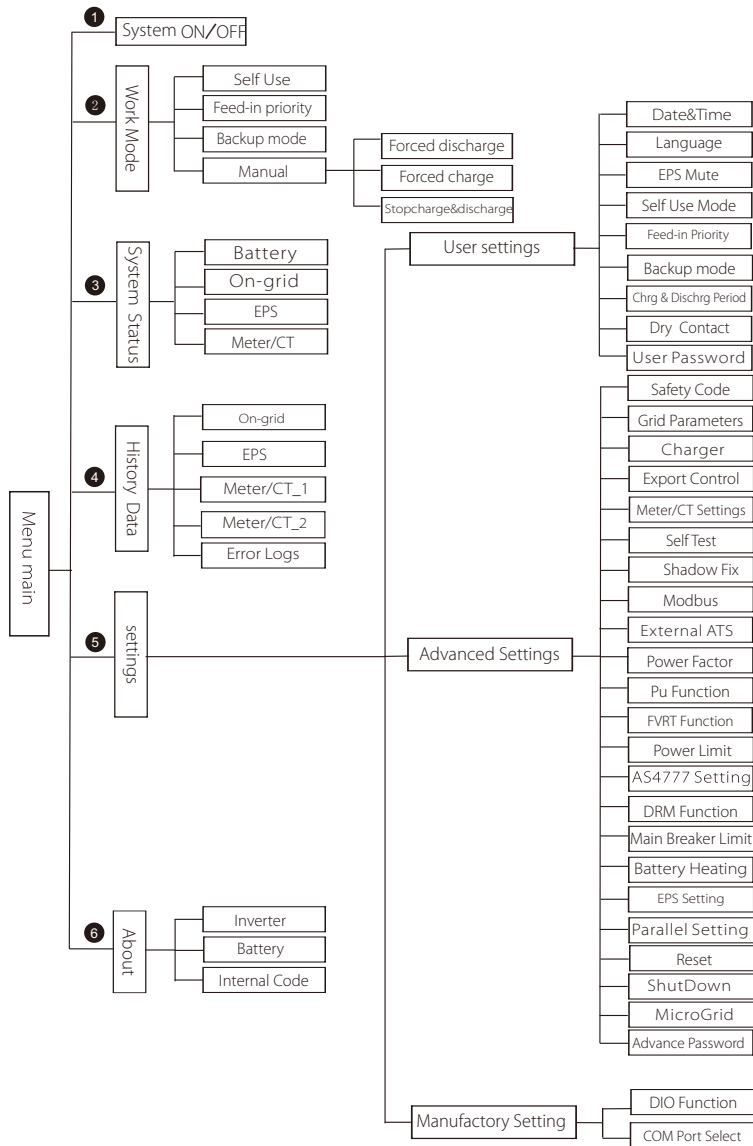

7.3 LCD Operation

The main interface is the default interface, the inverter will automatically return to this interface when the system started up successfully or not operated for a period of time.

The information of the interface is as below. "Power" means the instant output power; "Today" means the power generated within the day. "Battery" means the left capacity of battery energy.

Power	0W
Today	0.0KWh
Battery	80%
	Normal

➤ Menu interface

The menu interface is another interface for users to change settings or obtain information.

-When the LCD displays the main interface, click "OK" to enter this interface.

-The user can select up and down the menu, and press the "OK" key to confirm.

Menu	
>	System ON/OFF
	Work Mode
	System Status

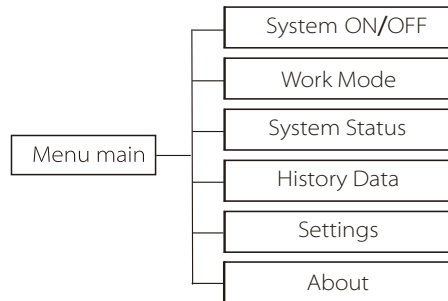

➤ System ON/OFF

"ON" indicates that the inverter is in working state, which is generally the default state.

"OFF" means that the inverter stops running and only the LCD screen is turned on.

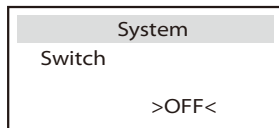

➤ Mode Selection

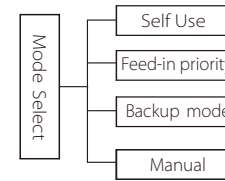

Mode selection, X1-Fit G4 has 4 working modes to choose from when used with a grid-connected inverter.

Name	Description
Self Use	<p>The self-use mode is suitable for areas with low feed-in subsidies and high electricity prices.</p> <p>① When the power of PV is sufficient Active Charging or Discharge time period: PV will power the loads firstly, and surplus power will charge to the battery. If the battery is fully charged, then sell the surplus power to the grid; (The inverter will limit the output if Feed-in limit or zero feed-in is needed) (PV > Load, PV → Load → Battery → Grid)</p> <p>② When the power of PV is insufficient Active Charging time period: PV will power the loads firstly, the remaining power will be taken from the grid, the battery will not discharge at this time. (PV < Load, PV + Grid → Load)</p> <p>Active Discharge time period: PV+BAT will power the loads together. If the power is still not enough, the remaining power will be taken from the grid. (PV < Load, PV + Battery + Grid → Load)</p> <p>③ Without PV power Active Charging time period: The grid supplies the loads and also can charge the battery; (PV=0, Grid → Load + Battery)</p> <p>Active Discharge time period: The battery will power the home loads firstly. If the battery power is not enough, the remaining power will be taken from the grid. The inverter will enter into the idle mode. (PV=0, Battery+Grid → Load) Battery min SOC can be set:10%-100%; Charge battery to min SOC can be set:10%-100%.</p>
Feed-in priority	<p>The Feed-in priority mode is suitable for areas with high feed-in subsidies, but has feed-in power limitation.</p> <p>① When the power of PV is sufficient Active Charging time period: First, PV supply power to the load, then charge the battery to the set capacity, and then sell the power to the grid. If the local grid company limits the grid-connected power of the inverter, the excess energy continues to charge the battery. (PV>Load, PV → Load → Battery → Grid → Battery)</p> <p>Active Discharge time period: PV will power the loads firstly, and surplus power will feed-in to the grid. (PV<Load, PV → Load → Grid)</p>

Feed-in priority	<p>② When the power of PV is insufficient Active Charging time period: PV will power the loads firstly, the remaining power will be taken from the grid. The battery will not discharge. (PV < Load, PV + Grid → Load) Discharge time period: PV+BAT will power the loads together. If the power is still not enough, the remaining power will be taken from the grid. (PV < Load, PV + Battery + Grid → Load)</p> <p>③ Without PV power Active Charging time period: The grid will power the home loads and also charge the battery; (PV=0, Grid → Load +Battery) Active Discharge time period: The battery will power the home loads firstly. If the battery power is not enough, the remaining power will be taken from the grid. The inverter will enter into the idle mode. (PV=0, Battery+Grid → Load) Battery min SOC can be set: 10%-100%. Charge battery to min SOC can be set: 10%-100%.</p>
Backup mode	<p>The back-up mode is suitable for areas with frequent power outages. Same working logic with "Self-use" mode. This mode will maintain the battery capacity at a relatively high level. (Users' setting) to ensure that the emergency loads can be used when the grid is off. Customers no need to worry about the battery capacity. Battery min SOC can be set: 30%-100%; Charge battery to min SOC can be set: 30%-100%.</p>
EPS	<p>The EPS mode is used when the power grid is off. System will provides emergency power through PV and batteries to supply power to the household loads. (Battery is necessary)</p> <p>① When the power of PV is sufficient PV will power the loads firstly, and surplus power will charge to the battery. (PV > Load, PV → Load → Battery)</p> <p>② When the power of PV is insufficient The remaining power will be taken from the battery. (PV < Load, PV+Battery → Load)</p> <p>③ Without PV power The battery will power the emergency loads until the battery reached the min SOC, then the inverter will enter into the idle mode. (PV=0, Battery → Load) EPS SOC-min condition is adjustable within the range of 10%-25%;</p>

Note: in the case of grid connection, all working modes work normally when the battery SOC > 5%. When the battery charge rate is below 5%, the Grid will first charge the battery SOC 11%, and then return to the working mode selected by the user.

- Manual mode (manual mode), there are three options to choose from: forced charging, forced discharge, stop charging and discharging (grid-connected 0 power).

<p>Work Select</p> <p>>Manual Forced Charge</p>	<p>Work Select</p> <p>>Manual Forced Discharge</p>	<p>Work Select</p> <p>>Manual Stop Chrg&Dischrg</p>
---	--	---

➤ System Status

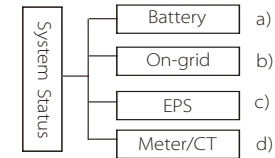

System status contains six content: Battery/On-grid (energy feed into or buy from the grid) and EPS and so on. Press up and down to select, press "Enter" to confirm the selection, and press "ESC" to return to the menu.

System Status	
Battery	
On-grid	
EPS(On-grid)	

a) Battery

This status shows the battery condition of the system. Including battery voltage and battery current, Battery power, battery capacity, battery temperature, BMS connection status. The meaning of the sign of battery current and power: "+" means charging; "-" means discharging.

Battery	
U	400.0V
I	-1.0A
P	-400W

b) On-grid

Here you can see the voltage, current, frequency, and power of the grid.

On-grid	
U	0.0V
I	0.0A
P	0.0W

c) EPS

Here you can see the voltage, current, frequency and power of the inverter when it is disconnected from the grid.(When the inverter is EPS, the EPS data will be displayed)

EPS	
U	0.0V
I	0.0A
P	0.0VA

d) Meter/CT

Here you can see the data showing the meter or the CT.

Meter/CT	
>Meter/CT-1	
Meter/CT-2	

Meter/CT	
>Meter/CT-1	4000w

Meter/CT	
>Meter/CT-2	4000w

➤ History Yield

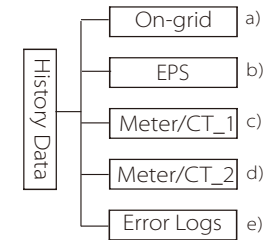

The history data contains five pieces of information: on-grid power of the inverter, EPS power generation, power of the meter/CT and error Error logs.

Press up and down to select, press Enter to confirm selection, and press ESC to return to the menu.

a) On-grid

Here is a record of the power capacity of the inverter connected to the grid today and the total.

On-grid	
Output Today	
Output Total	
Input Today	

b) EPS

Here you can see the EPS output of the inverter today and the total output.

EPS	
Today	
Total	00.0KWh

c) Meter /CT-1 Here you can see the inverter electricity sold, total electricity sold, electricity bought from the grid and total electricity bought on that day.

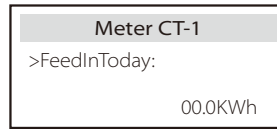

d) Meter /CT-2 Here you can see the total power output of the inverter for the day.

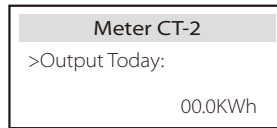

e) Error Logs Here you can see the most recent six error messages.

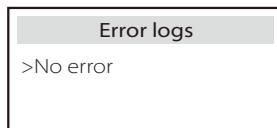

➤ Settings

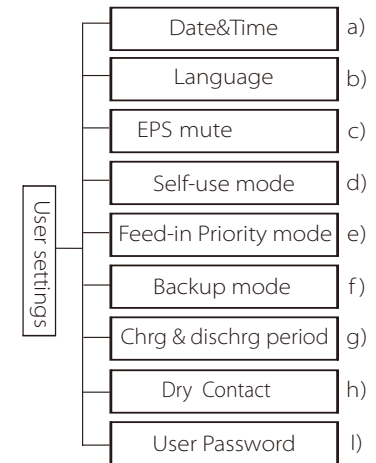

Here you can set the inverter time, language, working mode, charging and discharging time period and user password.

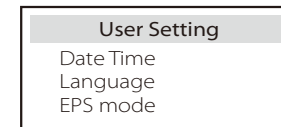

a) Date time This interface is for users to set the system date and time.

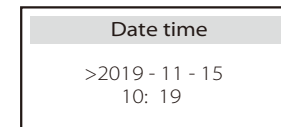

b) Language This inverter provides multiple languages for customers to choose.

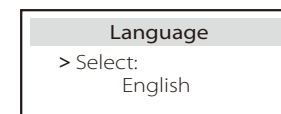

c) EPS Mute

Here you can choose whether the buzzer is turned on when the inverter is running in EPS mode. Select Yes, the buzzer mutes, select NO, EPS mode, the buzzer will sound once every 4s when the battery is fully charged, the closer the battery is to the empty state, the higher the buzzer will sound, to remind users to avoid battery loss.

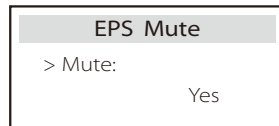

d) Self-use mode

In this mode, you can set the power reserve percentage of the minimum battery state, set whether the power can be taken from the mains side to charge the battery, and set the amount of power to charge the battery. For example: set the reserved minimum SOC of the battery capacity to "10%", which means that when the battery has been discharged to 10% of the battery capacity, the battery is not allowed to continue to discharge;

Charge battery to is set to 90%, indicating that the mains is allowed to charge the battery at 90%.

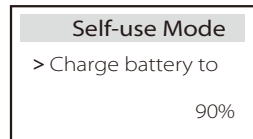
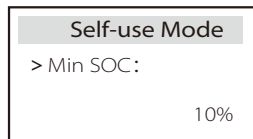

e) Feed-in Priority mode

In this mode, you can set the power reserve percentage of the minimum battery state and set the amount of power to charge the battery. For example: set the reserved minimum SOC of the battery capacity to "10%", which means that when the battery has been discharged to 10% of the battery capacity, the battery is not allowed to continue to discharge;

Charge battery to is set to 90%, indicating that the mains is allowed to charge the battery at 90%.

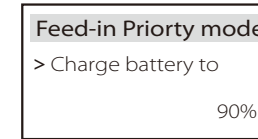
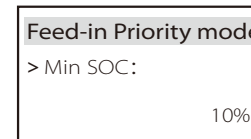

f) Backup mode

In this mode, you can set the power reserve percentage of the minimum battery state, and set the amount of power to charge the battery.

For example: set the reserved minimum SOC of the battery capacity to "30%", which means that when the battery has been discharged to 30% of the battery capacity, the battery is not allowed to continue to discharge;

Charge battery to is set to 90%, indicating that the mains is allowed to charge the battery at 90%.

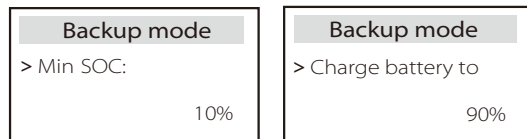

g) Charge and discharge time

Here you can set the charge and discharge time period.

If two charging and discharging periods are needed, turn on the charging and discharging period 2 and set the period.

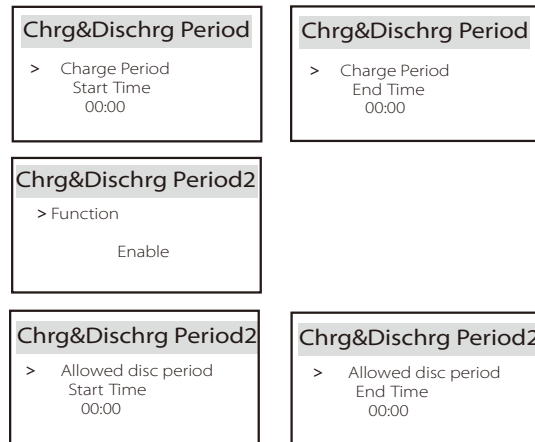

h) Dry Contact

When the user uses the inverter communication control external device function, you can enter here to set the parameters of the external response control. For the setting method, please refer to the user manual of the compatible external device.

If the user uses the inverter dry contacts to control external devices (such as heat pumps) through the Adapter box, please refer to the Adapter box quick installation manual to set the parameters here.

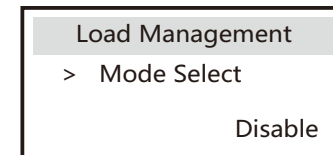

l) User Password

The default password for the end user is "0000", where you can reset the new password and press the up/down key to increase or decrease the value. Press "Enter" to confirm the value and jump to the next digit. When all passwords have been entered and confirmed, press "OK" to set the password successfully.

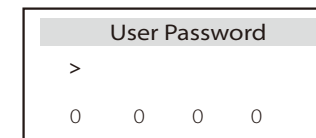

➤ Advance settings

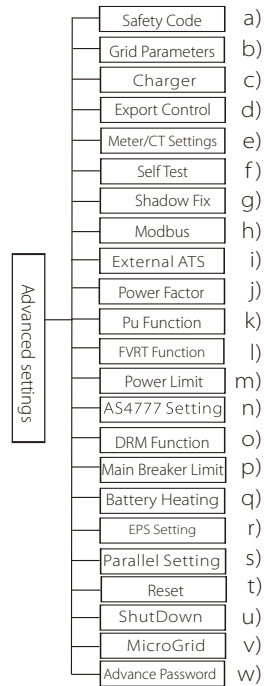

All advanced settings can be set here, such as battery, grid, EPS, etc.. "Advanced" setting is generally customization and resetting for battery and grid. Each part has lower level parts. Please contact your installer or factory and enter the installer password.

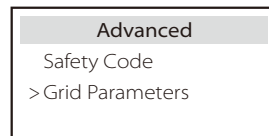

a) Safety Code

User can set safety standard according to different countries and grid tied . There are now 1 standards to choose from. (The here may be changes in the future, please refer to the screen display)

Item	Standard	Country
1	ARN 4105	German

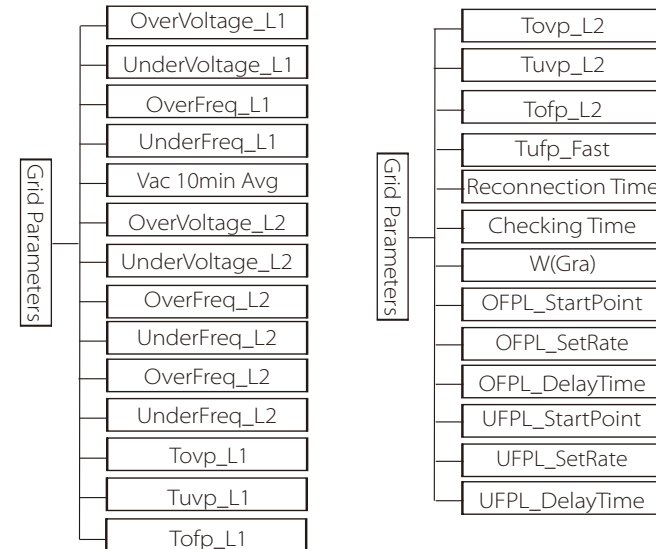

b) Grid Parameters

Here you can set the protection value of grid voltage and frequency. The default value is the specified value under the current safety regulations, and the user cannot change it .

The display content will be displayed according to the requirements of local laws and regulations, which are constantly increasing. Please refer to the contents displayed on the inverter screen.

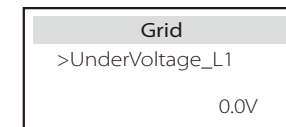
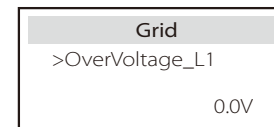

Grid	Grid
>OverFreq_L1 0.0Hz	>UnderFreq_L1 0.0Hz
Grid	Grid
>Vac 10min Avg 0.0V	>OverVoltage_L2 0.0V

c) Charger

Here the user can set the parameters of charger on this page, the inverter is compatible with both lithium battery. Users can set the charge & discharge parameters.

For the detailed parameters, please refer to below table.

Charger	Charger
Charge Max Current 25A	Discharge Max Current 25A

d) Export Control

This feature allows the inverter to control the amount of electricity output to the grid.

The factory value is the default and can be changed by the user. The user value set by setup must be less than the maximum. If the user does not want to supply power to the grid, set it to 0.

Export Control
User value: 0W

e) Meter/CT Settings

The user needs to select the CT or electricity meter to connect the inverter here. Select the address of the meter. CT does not need to select the address.

CT/Meter Setting	CT/Meter Setting
> Select Meter	> Meter 1 Addr: xxxxxxx

f) Self Test (only for CEI 0-21/ACEA

The self test function allows users to test the following items. "Full test", "Ovp(59.S2) test", "Uvp (s1) test", "Uvp (27. s2) test", "Ofp (81>. S1) test", "Ufp (81 <.S1) test", "Ufp (81>. S2) test", "Ufp (81 <.S2) test", "Ovp10 (59. s1) test".

In the self-test interface, the user can select "all tests" or a single test item for testing.

Before testing, make sure that the inverter is connected to the grid.

All tests take about 6 minutes. And it will display "Success" and then "Delivery".

For a single test item, it takes about a few seconds or minutes.

Click "Test Report" to view the test results of all items.

Self Test
ALL Test
Test report
Uvp(27.S1) test

>Ofp2(81>.S2)result	>Ovp2(59.S2)result
Ft: 51.50Hz Tt:1000ms Fs: 0.00Hz To: 998ms F0: 0.00Hz pass	Vt: 264.5V Tt: 300ms Vs: 0.0V To: 200ms V0: 0.0V pass
>Ofp2(27.S2)result	>Uvp2(27.S1)result
Vt: 92.0V Tt: 200ms Vs: 0.0V To: 196ms V0: 0.2V pass	Vt: 195.5V Tt: 400ms Vs: 0.0V To: 200ms V0: 0.0V pass
>Ofp2(81>S1)result	>Ufp2(81<.S1)result
Ft: 50.50Hz Tt: 100ms Fs: 0.00Hz To: 96ms F0: 0.2Hz pass	Ft: 49.50Hz Tt: 100ms Fs: 0.00Hz To: 98ms F0: 0.02Hz pass
>Ufp2(81<.S2)result	>Ovp10(59.S1)result
Ft: 47.50Hz Tt: 400ms Fs: 0.00Hz To: 3999ms F0: 0.02Hz pass	Vt: 253.0V Tt: 600ms Vs: 0.0V To: 598ms V0: 0.0V pass

g) Shadow Fix

If the user's PV module is blocked by a fixed object, you can turn on the shadow tracking setting low, middle, and high here. If there is no object blocked, please choose to turn off this function.

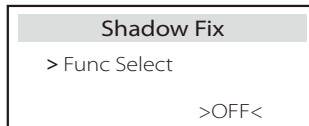

h) Modbus

Here you select the baud rate of the external communication protocol, the default location of 19200 and 485 addresses.

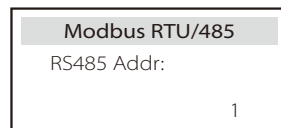
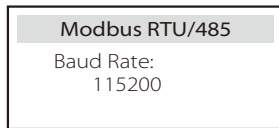

i) External ATS

If you want Matebox installed, you need to turn this feature on here.

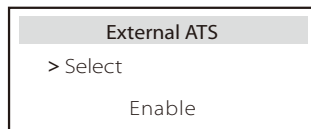

j) Power Factor (applicable to specific countries, please refer to local grid requirements.)

There are 6 modes for selecting: Off, Under-Excited, Over-Excited, Curve, Q(u).

(May be changed or added without notice)

User press up and down key to select, press enter key to confirm.

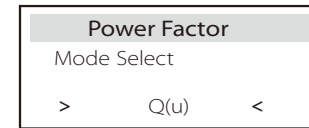
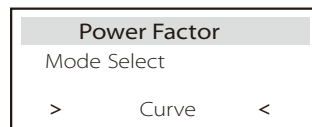
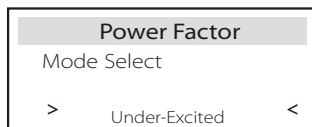
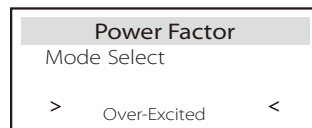
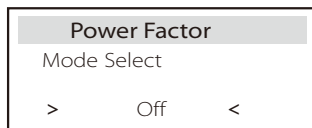

Mode	Comment
Off	-
Over-Excited	PF value
Under-Excited	PF value
Curve	Upper limit
	Lower limit
	Power Upper
	Power Lower
	PFLockInPoint (CEI 0-21 only)
	PFLockOutPoint (CEI 0-21 only)
Q(u)	3Tau
	VoltRATIO 1 (AS4777.2 only)
	VoltRATIO 4 (AS4777.2 only)
	QURESPONSEV2 (AS4777.2 only)
	QURESPONSEV3 (AS4777.2 only)
Fixed Q Power	QURESPONSEV4 (AS4777.2 only)
	K Value (CEI 0-21 only)
Q Power	Q Power

- Reactive power control, reactive power standard curve $\cos \varphi = f(P)$

For VDE ARN 4105, the curve $\cos = f(P)$ should refer to curve B. The set default value is shown in curve B.

For e8001, the curve $\cos = f(P)$ should be curve A. The set default value is shown in curve A.

For CEI 0-2, the default value of PFLockInPoint is 1.05. When $V_{ac} > 1.05V_n$, $P_{ac} > 0.2 P_n$, curve $\cos \varphi = f(P)$ corresponds to curve B.

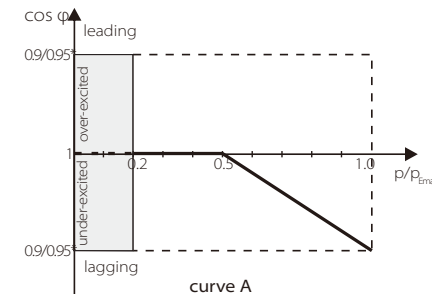

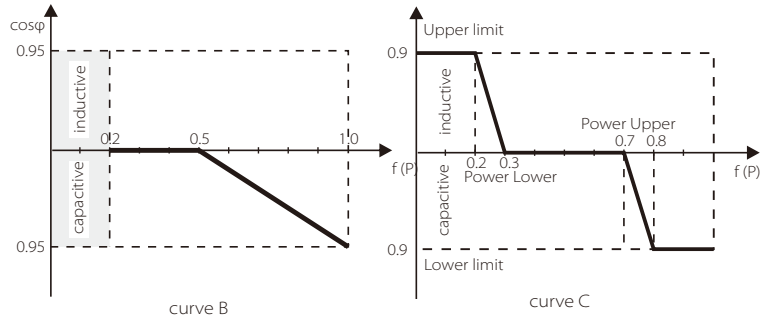

- Reactive power control, reactive power standard curve $Q = f(V)$

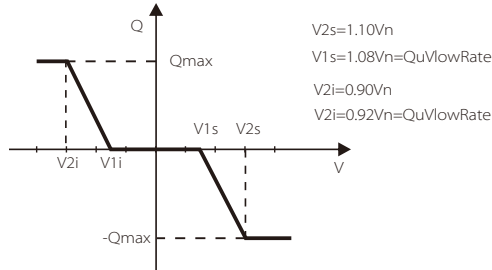

- k) PU Function (applicable to specific countries, please refer to local grid requirements)

The PU function is a volt-watt response mode required by certain national standards such as AS4777.2. This function can control the active power of the inverter according to the grid voltage. Selecting "Enable" means that this function is turned on and is the default value. Select "Disable" to deactivate the function.

PU Function >PuFunction Enable	PU Function Response V2 220.0V
PU Function Response V3 250.0V	PU Function Response V4 265.0V

- l) FVRT Function(apply to50549)
Here you can set the high and low enable or disable.

FVRT Function	
Function Control	
Disable	Enable

- m) Power limit
Power limit function, the maximum power of the AC port can be set by percentage.

Power Limit	
>Proportion	1.00

- n) AS4777 Setting
It is the same as the function of Export Control, but it's only applicable to Australia and New Zealand.

AS4777 Setting >Export Control General Control	Export Control >Soft Limit Enable	Export Control >Soft Limit Value 00000W
---	--	--

- o) DRM function (applied to NZS4777.2)
The DRM function is a demand response method required by the NZS4777.2 standard and is only applicable to NZS4777.2. The default value is "enable". Select "Disable" to disable this function.

DRM Function	
>Function Control	
Enable	

- p) Main Breaker Limit
Here you can set the maximum current of the main MCB on the user's home side.

Main Breaker Limit	
>Current	40A

q) Battery Heating

If the user needs the battery heating function, you can set it to turn on here, and set the time period that needs to be heated, and the two time periods can be set. (Only for batteries with heating function)

Battery Heating >Func Select: Enable Disable	Battery Heating >Heating Period 1 Start Time 00:00	Battery Heating >Heating Period 1 End Time 00:00
Battery Heating >Heating Period 2 Start Time 00:00	Battery Heating >Heating Period 2 End Time 00:00	

r) EPS Setting

User can set the frequency selection in the EPS mode here, and set the minimum capacity reserved for battery discharge.

EPS Setting > Frequency 50Hz	EPS Setting >Frequency 60Hz	EPS Setting > Min SoC 10%
---	--	--

s) Parallel Setting (a function for parallel operation)

If a parallel operation is required, the user may set it with Parallel Setting.

Parallel Setting > Status setting Free > Master <	Parallel Setting > Status setting Free Free
---	---

t) Reset

Users can reset the reset error log, meter power, inverter power, and restore factory settings here.

Reset Error Log >Reset Yes	Reset Meter/CT_1 >Reset Yes	Reset Meter/CT_2 >Reset Yes
Reset INV Energy >Reset Yes	Factory Reset >Reset Yes	

u) ShutDown

ShutDown is an Enable Switch. If the user wanna use ShutDown, the Enable mode can be set.

ShutDown ShutDown > Enable <

v) MicroGrid

If the user wanna use MicroGrid, the Enable mode can be set.

MicroGrid >MicroGrid Enable
--

w) Advance Password

Here you can reset the advanced password. "Set Successfully!" is displayed on success, and "Setup Failed!" Will also displayed on failure.

Advance Password Set Successfully!	Advance Password Setup failed
--	---

➤ Manufactory Setting

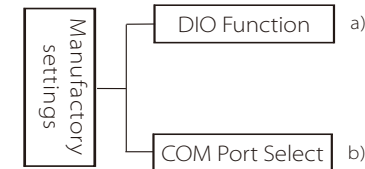

a) DIO Function

The reserved functions will be displayed after being added later.

DIO Function >function Enable
--

b) COM Port Select

Here external communication protocol or external indoor screen of the inverter can be set. When it is used for external communication protocol, it can choose RS485 or MOBUS. When it is used for external indoor screen, it can choose YES or NO.

RS485/MOBUS > RS485 MOBUS	External LCD > Yes No
--	------------------------------------

➤ About

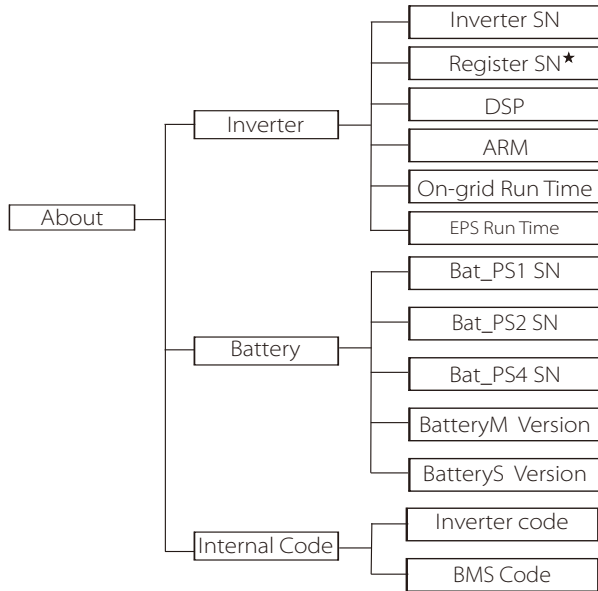

★ Register1 SN: Represents the serial number of external monitoring equipment, such as Pocket WiFi, Pocket LAN and Pocket GPRS.

a) About

Here you can see some basic information of the inverter and battery, such as the inverter and battery SN number, software version number, and system run time.

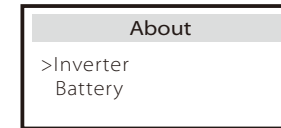

Inverter

<p>Inverter</p> <p>>Inverter SN 01234560123456</p>	<p>Inverter</p> <p>>Register 01234560123456</p>
<p>Inverter</p> <p>>DSP 2.07</p>	<p>Inverter</p> <p>>ARM 1.03</p>
<p>Inverter</p> <p>>EPS Runtime 20.0H</p>	<p>Inverter</p> <p>>On-grid runtime 45.9H</p>

Battery

Battery >BatBrand:BAK	Battery >Bat-MSN 6S012345012345
Battery >Bat-PS1 SN 6S012345012345	Battery >Bat-PS2 SN 6S012345012345
Battery >Bat-PS3 SN 6S012345012345	Battery >Bat-PS4 SN 6S012345012345
Battery >BatteryM Version 2.01	Battery >BatteryS Version 2.01

Internal Code

Internal Code >Inverter code 01 00 01 xx	Internal Code >BMS code
Internal Code >BAT-M 2.01	Internal Code >BAT-S1 1.01 50
Internal Code >BAT-S2 1.01 50	••• Internal Code >BAT-S8 1.01 50

8 Troubleshooting

8.1 Troubleshooting

This section contains information and procedures for resolving possible problems with X1-Fit G4, and provides you with troubleshooting tips to identify and solve most problems that may occur in X1-Fit G4. This section will help you narrow down the source of any problems you may encounter. Please read the troubleshooting steps below. Check the warning or fault information on the system control panel or the fault code on the inverter information panel. If a message is displayed, log it before doing anything further.

Try the solutions indicated in the table below.

Number	Faults	Diagnosis and solution
IE 001	TZ Protect Fault	Overcurrent fault. • Wait for a while to check if you're back to normal. • Disconnect batteries, reconnect. • Or ask for help from the installer if it can not return to normal.
IE 002	Grid Lost Fault	• Check battery input voltage if it's within normal range • Or ask the installer for help.
IE 003	Grid Volt Fault	Power grid voltage overrun • Wait a moment, if the utility returns to normal, the system will reconnect. • Please check if the grid voltage is within normal range. • Or ask the installer for help.
IE 004	Grid Freq Fault	Electricity frequency beyond range • If the utility returns to normal, the system reconnects. • Or ask the installer for help.
IE 006	Bus Volt Fault	• press the "ESC" key to restart the inverter. • Or ask the installer for help.
IE 007	Bat Volt Fault	Battery voltage fault • Check battery input voltage if it's within normal range • Or ask the installer for help.
IE 008	AC10M Volt Fault	• The grid voltage was out of range in the last 10 minutes. • The system will return to normal if the grid returns to normal. • Or ask the installer for help.

Number	Faults	Diagnosis and solution
IE 009	DCI OCP Fault	DCI overcurrent protection fault. • Wait for a while to check if it's back to normal. • Or ask the installer for help.
IE 010	DCV OVP Fault	DCV EPS overvoltage protection failure. • Wait for a while to check if it's back to normal. • Or ask the installer for help.
IE 011	SW OCP Fault	Software Detection of Overcurrent Fault. • Wait for a while to check if it's back to normal. • Shut down photovoltaic, battery and grid connections • Or ask the installer for help.
IE 012	RC OCP Fault	Overcurrent protection fault. • Check the impedance of DC input and AC output. • Wait for a while to check if it's back to normal. • Or ask the installer for help.
IE 013	Isolation Fault	Insulation fault • Please check the wire insulation for damage. • Wait for a while to check if it's back to normal. • Or ask the installer for help.
IE 014	Temp Over Fault	Temperature beyond limit • Check if ambient temperature exceeds the limit. • Or ask the installer for help.
IE 015	Bat Con Dir Fault	EPS mode current is too strong. • Ensure that the load power is within the EPS power range. • Check for any non-linear load connections on the EPS • Move this load to check for recovery. • Or ask for help from the installer if it can not return to normal.
IE 016	EPS Overload Fault	EPS over load fault. • Shutdown the high-power device and press the "ESC" key to restart the inverter. • Or ask for help from the installer if it can not return to normal.
IE 017	OverLoad Fault	On-grid mode over load • Shutdown the high-power device and press the "ESC" key to restart the inverter. • Or ask for help from the installer if it can not return to normal.
IE 018	BatPowerLow	• Close the high-power device and press the "ESC" key to restart the inverter. • Please charge the battery to a level higher than the protection capacity or protection voltage
IE 019	BMS Lost	Battery communication loss • Check that the communication lines between the battery and the inverter are properly connected. • Or ask for help from the installer if it can not return to normal.
IE 020	Fan Fault	Fan fault • Check for any foreign matter that may have caused the fan not to function properly. • Or ask for help from the installer if it can not return to normal.
IE 021	Low Temp	Low temperature fault. • Check if the ambient temperature is too low. • Or ask for help from the installer if it can not return to normal.

Number	Faults	Diagnosis and solution
IE 022	ARM Unmatched	ARM software version mismatch Fault • update the software and press the ESC" key to restart the inverter. • Or ask for help from the installer if it can not return to normal .
IE 023	Other Device Fault	Other device Fault • update the software and press the ESC" key to restart the inverter. • Or ask for help from the installer if it can not return to normal .
IE 025	InterComms Error	Mgr interCom fault • Shut down battery and grid, reconnect. • Or ask for help from the installer if it can not return to normal .
IE 025	InterComms Error	• Internal communication errors • Shut down battery and grid connections. • Or ask for help from the installer if it can not return to normal.
IE 026	Inv EEPROM Fault	Inverter EEPROM fault. • Shut down photovoltaic, battery and grid, reconnect. • Or ask for help from the installer if it can not return to normal.
IE 027	RCD Fault	Fault of residual current device • Check the impedance of DC input and AC output. • Disconnect batteries, reconnect. • Or ask for help from the installer if it can not return to normal.
IE 028	Grid Relay Fault	Electrical relay failure • Disconnect batteries and reconnect. • Or ask for help from the installer if it can not return to normal.
IE 029	EPS Relay Fault	EPS relay failure • Disconnect grid and batteries and reconnect. • Or ask for help from the installer if it can not return to normal.
IE 031	ChargerRelayFault	Charge relay fault • Press the ESC" key to restart the inverter. . • Or ask for help from the installer if it can not return to normal.
IE 032	EarthRaleyFault	EPS earth relay fault • Press the ESC" key to restart the inverter. . Or ask for help from the installer if it can not return to normal.
IE 101	PowerTypeFault	Power type fault • Upgrade the software and press the ESC" key to restart the inverter. • Or ask for help from the installer if it can not return to normal.
IE 102	Port OC Warning	EPS port over current fault • Check that the EPS load does not exceed the system requirements, and press the ESC" key to restart the inverter. . • Or ask for help from the installer if it can not return to normal.

Number	Faults	Diagnosis and solution
IE 103	Mgr EEPROM Fault	Manager EEPROM fault. • Shut down battery and grid, reconnect. • Or seek help from the installer if it can not return to normal.
IE 104	DSPUnmatched	DSP version error. • Check that the DSP1 version matches • Or seek help from the installer if it can not return to normal.
IE 105	NTC Sample Invalid	NTC invalid • Make sure the NTC is properly connected and the NTC is in good condition. • Please confirm that the installation environment is normal • Or ask for help from the installer, if it can not return to normal.
IE 106	Bat Temp Low	Battery temp low • Check the battery installation environment to ensure good heat dissipation. • Or ask for help from the installer, if it can not return to normal.
IE 107	Bat Temp High	Battery temp high • Check the battery installation environment to ensure good heat dissipation. • Or ask for help from the installer, if it can not return to normal.
IE 109	Meter Fault	Meter error • Please check that the instrument is working properly • Or seek help from the installer if it can not return to normal.
IE 110	BypassRaleyFault	Bypass relay fault • Press the ESC" key to restart the inverter. . • Or ask for help from the installer if it can not return to normal.
BE 001	BMS_External_Err	Battery Error - External Communication Fault • Please contact the battery supplier.
BE 002	BMS_Internal_Err	Battery Error - Internal Communication Fault • Please contact the battery supplier.
BE 003	BMS_OverVoltage	Over voltage in battery system • Please contact the battery supplier.
BE 004	BMS_LowerVoltage	Low voltage in battery system • Please contact the battery supplier.
BE 005	BMS_ChargeOCP	Battery fault - over charge fault • Please contact the battery supplier.
BE 006	BMS_DischargeOCP	Battery fault-discharge over current fault • Please contact the battery supplier.
BE 007	BMS_TemHigh	Over temperature in battery system • Please contact the battery supplier.
BE 008	BMS_TempSensor Fault	Battery temperature sensor malfunction • Please contact the battery supplier.

Number	Faults	Diagnosis and solution
BE 009	BMS_CellImblance	Battery unbalanced failure • Please contact the battery supplier.
BE 010	BMS_Hardware Protect	Battery hardware protection failure • Please contact the battery supplier.
BE 011	BMS_Circuit_Fault	Battery circuit failure • Restart the battery. • Please contact the battery supplier.
BE 012	BMS_ISO_Fault	Battery insulation failure • Check that the battery is properly grounded and restart the battery. • Please contact the battery supplier.
BE 013	BMS_VolSen_Fault	Battery voltage sensor fault • Please contact the battery supplier.
BE 014	BMS_TemppSen_Fault	Temperature sensor failure • Restart the battery . • Please contact the battery supplier.
BE 015	BMS_CurSensor Fault	Battery current sensor fault • Please contact the battery supplier.
BE 016	BMS_Relay Fault	Battery relay failure • Please contact the battery supplier.
BE 017	BMS_Type_Unmatch	Battery type failure • Upgrade the battery BMS software. • Please contact the battery supplier.
BE 018	BMS_Ver_ Unmatch	Battery version mismatch failure • Upgrade the battery BMS software. • Please contact the battery supplier.
BE 019	BMS_MFR_ Unmatch	Battery manufacturer did not match the fault • Upgrade the battery BMS software. • Please contact the battery supplier.
BE 020	BMS_SW_ Unmatch	Battery hardware and software mismatch failure • Upgrade the battery BMS software. • Please contact the battery supplier.
BE 021	BMS_M&S_ Unmatch	Battery master slave control mismatches • Upgrade the battery BMS software. • Please contact the battery supplier.
BE 022	BMS_CR_ NORespond	Battery charging request does not respond to a fault • Upgrade the battery BMS software. • Please contact the battery supplier.
BE 023	BMS_SW_ Protect	Battery slave software protection failure • Upgrade the battery BMS software. • Please contact the battery supplier.
BE 024	BMS_536_Fault	Battery fault-discharge over current fault • Please contact the battery supplier.
BE 025	BMS_SelfcheckErr	Over temperature in battery system • Please contact the battery supplier.

Number	Faults	Diagnosis and solution
BE 026	BMS_TempdiffErr	Battery temperature sensor malfunction • Please contact the battery supplier.
BE 027	BMS_BreakFault	Battery unbalanced failure • Please contact the battery supplier.
BE 028	BMS_Flash_Fault	Battery hardware protection failure • Please contact the battery supplier.
BE 029	BMS_Precharge_Fault	Battery precharge failure • Please contact the battery supplier.
BE 030	BMS_AirSwitch_Fault	Battery air switch failure • Check that the battery breaker is off. • Please contact the battery supplier.

- If the information panel of your inverter does not show the fault light, check the following list to ensure the current installation status, correct operation.

- Is the inverter located in a clean, dry and well-ventilated place?
- Is the DC input circuit breaker open?
- Is the specification and length of the cable adequate?
- Are the input and output connections and wiring in good condition?
- Is the configuration set correct for your particular installation?

Please contact SolaX customer service for further assistance. Please be prepared to describe the details of your system installation and provide the inverter serial number.

8.2 Routine Maintenance

Inverter do not require any maintenance or correction in most cases, but if the inverter often loses power due to overheating, this can be attributed to the following reason:

- heat sink behind the inverter is covered with dirt.
If necessary, clean the cooling heat sink with a soft dry cloth or brush.
Only trained and authorized professionals familiar with safety requirements can perform maintenance and maintenance work.

➤ Safety inspections

Safety checks should be conducted at least every 12 months, please contact the manufacturer to arrange for appropriate training, expertise, and practical experience in performing these tests. (Please note that this action is not covered by warranty). These data should be recorded in the device log. If the equipment is not running properly or any test fails, the equipment must be repaired for details of safety inspections, refer to section 2 of this manual for safety instructions and europe commission instructions.

➤ Regular maintenance

Only qualified people can do the following work.

In the process of using frequency converter, the manager should check and maintain the machine regularly. The specific operation is as follows.

1. Check whether the heat sink is covered with dirt, clean the inverter and absorb dust if necessary. This work should be performed from time to time.
2. Check whether the frequency converter indicator is normal, check whether the frequency converter button is normal, check whether the frequency converter display is normal. This inspection should be conducted at least every 6 months.
3. Check the input and output lines for damage or aging. This inspection should be conducted at least every 6 months.

9 Decommissioning

9.1 Disassemble of Inverter

- Remove DC input line and AC output line of inverter.
- Wait for at least 5 minutes to power off.
- Remove all cable connections from the inverter.
- Remove inverter from finger support the bracket.
- Remove the bracket if necessary.

9.2 Packing

Load the inverter into the original package if possible.

- If the original package can not be found, you can also use the following requirements of the carton packaging:
Bearing capacity of more than 30kg.
Easy to carry.
Can completely seal the cover.

9.3 Storage and Transportation

Store the inverter in a dry, temperature $-40^{\circ}\text{C}\sim 65^{\circ}\text{C}$ environment.
Pay attention to less than four inverter on each stack board during storage and transportation.

9.4 Waste Disposal

If it is necessary to scrap the inverter or other related parts, be sure to send the waste inverter and packaging materials to the designated location for recycling by the relevant department.

10 Disclaimer

The X1-Fit G4 series inverters are transported, used and operated under limited condition, such as environmental, electrical etc. SolaX shall not be liable to provide the service, technical support or compensation under conditions listed below, including but not limited to:

- Inverter is damaged or broken by force majeure (such as earthquake, flooding, thunderstorm, lighting, fire hazard, volcanic eruption etc).
- Inverter's warranty is expired and doesn't buy extended warranty.
- Can't provide the inverter's SN, warranty card or invoice.
- Inverter is damaged by man-made cause. Inverter is used or operated against any items in local policy.
- Inverter's installation, configuration, commissioning doesn't follow the requirements mentioned in this manual.
- Inverter is installed, refitted or operated in improper ways mentioned in this manual without authority from SolaX.
- Inverter is installed, operated under improper environment or electrical condition mentioned in this manual without authority from SolaX.
- Inverter is changed, updated or disassembled on hardware or software without authority from SolaX.
- Obtain the communication protocol from other illegal channels.
- Build monitoring, control system without authority from SolaX.
- Connect to other brands batteries without authority from SolaX.

SolaX will keep right to explain all the contents in this user manual.

Warranty Registration Form



For Customer (Compulsory)

Name Country

Phone Number Email

Address

State Zip Code

Product Serial Number

Date of Commissioning

Installation Company Name

Installer Name Electrician License No.

For Installer

Module (If Any)

Module Brand

Module Size(W)

Number of String Number of Panel Per String

Battery (If Any)

Battery Type

Brand

Number of Battery Attached

Date of Delivery Signature

Please visit our warranty website: <https://www.solaxcloud.com/#/warranty> to complete the online warranty registration or use your mobile phone to scan the QR code to register.

For more detailed warranty terms, please visit SolaX official website: www.solaxpower.com to check it.





PLEASE REGISTER THE WARRANTY
IMMEDIATELY AFTER INSTALLATION!
GET YOUR WARRANTY CERTIFICATE
FROM SOLAX!
KEEP YOUR INVERTER ONLINE & WIN
SOLAX POINTS!

1

Open your
camera app
and point
your device
at the QR
code



2

Wait for the
camera to
recognize
the QR code



3

Click banner
or notification
when it appears
on the screen



4

Warranty
registration
page will be
loaded
automatically

