

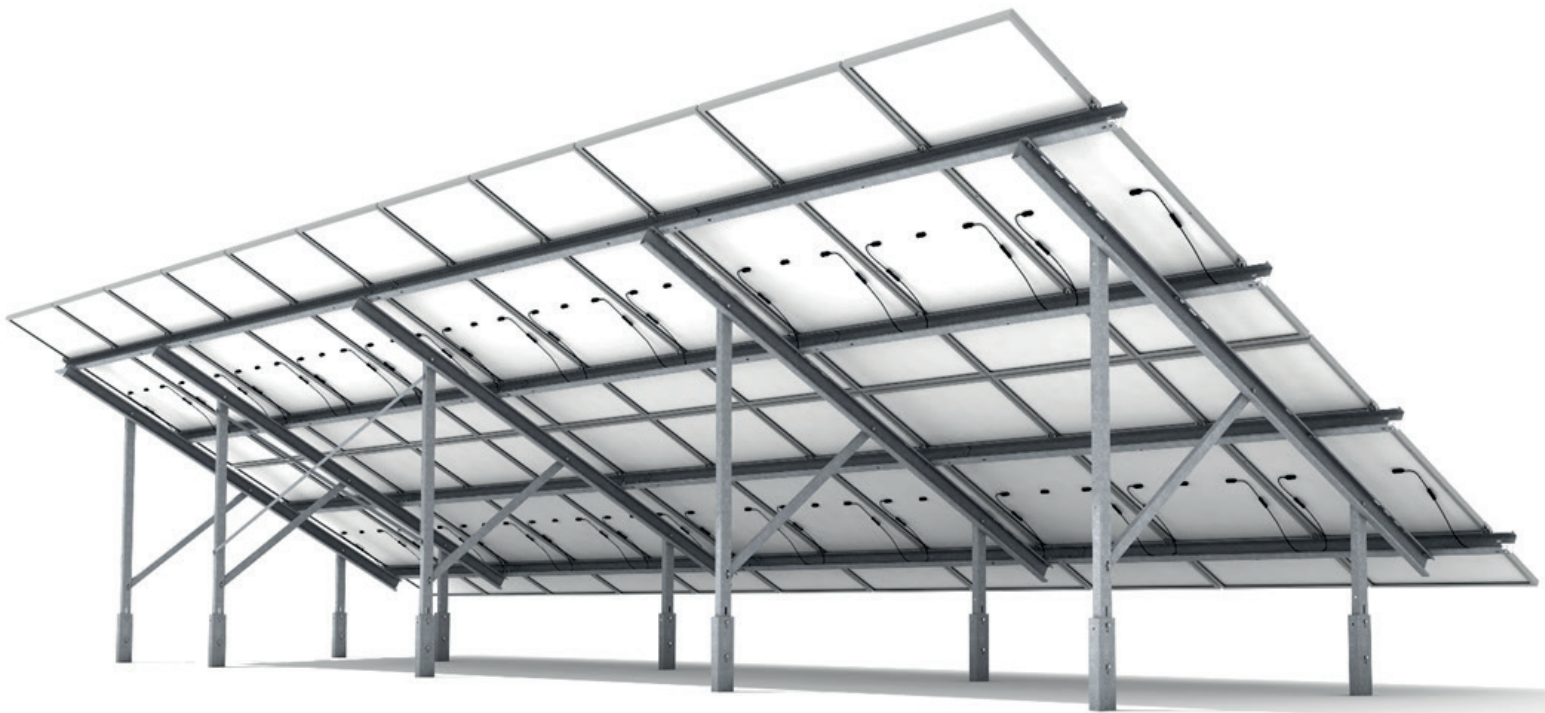

SOLARPORT



MODULAR
INSTALLATION GUIDE
2 IN PORTRAIT

CONTENTS

- INTRODUCTION 3
- RELEVANT DRAWING PACK 3
- HEALTH AND SAFETY GUIDANCE 3
- SYSTEM OVERVIEW 4
- INSTALLATION DIRECTIVES 6
- TOOLING GUIDANCE 6
- GENERAL OVERVIEW..... 6
- PILING CONSIDERATIONS 7
- FRAME ASSEMBLY METHODOLOGY ... 8
- STEP 1 – A-FRAME ASSEMBLY 8
- STEP 2 – PURLIN 10
- JOINER OPTIONS 12
- STEP 3 – SQUARING 12
- STEP 4 – PANEL FIXING 13
- STEP 5 – TRIM ASSEMBLY 15
- PIECE PARTS 25
- GENERAL GALVANISE CARE 19
- INSPECTION AND MAINTENANCE 19
- SYSTEM LIMITATIONS 20
- CHECKING PROCEDURE 20
- REVISION STATUS 20

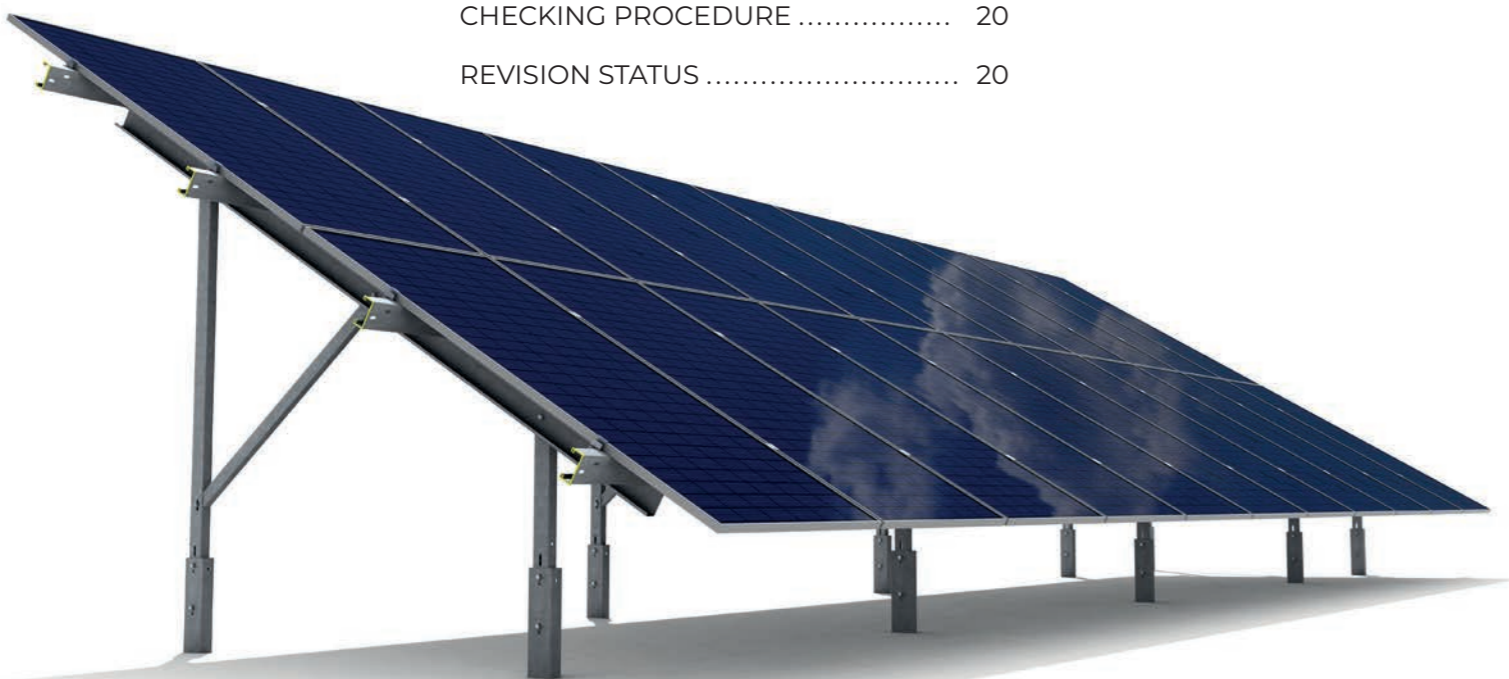

INTRODUCTION

The Modular System is designed to be simple to install. The construction of the system is straightforward. It requires a minimum of two people and a small selection of regular tools, no specialist equipment is required.

Your chosen panel requires that you follow the manufacturers installation guide. Solarport are not responsible for problems associated with their supply and installation.

If you are unsure of anything outlined in this installation manual, please do get in touch, we are always willing to assist you.

RELEVANT DRAWING PACK

This installation manual needs to be read in conjunction with the following site specific drawings. Please ensure you have the latest versions of these files before commencing any setting out or construction.

XXXX-UPA-001 XXXX-STA-001







HEALTH AND SAFETY GUIDANCE

For installation on sites where there are guidelines in place, please follow both them and the advice listed below:

Health and safety equipment to be supplied by the installer. Solarport Systems are a supply only manufacturer and do not supply any health and safety equipment.

All applicable codes and regulations must be observed while installation work is carried out. Such requirements may vary for site location in accordance with local governing rules. Please read this manual fully prior to the commencement of work.



When carrying out installation of Solarport framework, always comply with the following rules:



- | | | | |
|---|--|---|---|
|  | Gloves must be worn at all times when handling the product. |  | Observe site manual handling rules and regulations. |
|  | Head protection must be worn at all times when installing the product. |  | Observe high voltage rules and regulations. |
|  | Ear protection must be worn whilst working close to piling equipment. | | |
|  | Eye protection must be worn at all times when installing this product. | | |



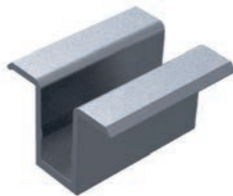
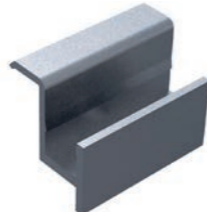

PIECE PARTS

The following components are to be used:

FRAME FIXINGS		
PART GRAPHIC	PART NUMBER	DESCRIPTION
	1	M12 x 30 Bolt
	2	M12 Nut
	3	M12 Washer
	4	M8 x 30 Hex head
	5	M8 Nut
	6	M8 Washer
	7	M8 x 30 Cap head bolt
	8	M8 Swing nuts
	9	M12 Nyloc Nut

CLAMPS FOR SOLAR PANELS		
PART GRAPHIC	PART NUMBER	DESCRIPTION
	10	Mid Clamps – Come pre-assembled with M8 caphead and channel nuts OR M8 bolts, washers and nuts
	11	End Clamps – Come pre-assembled with M8 caphead and channel nuts OR M8 bolts, washers and nuts
	12	Sliding Panel Clamp

GROUND MOUNTS		
PART GRAPHIC	PART NUMBER	DESCRIPTION
	13	C-Pile (2 variants) 2000mm driven (1500mm embedment) 1500mm auger/postcrete (1000mm embedment)
	14	Ballasted Mount
	15	X-Anchor
	16	Spirafix

FRAME STRUCTURE		
PART GRAPHIC	PART NUMBER	DESCRIPTION
	17	Upright (4 variants) Front Upright - Universal Rear Upright - 20 deg 1834mm Rear Upright - 25 deg 2033mm Rear Upright - 30 deg 2219mm
	18	Rafter (2 variants) RAF-001 - 3818mm RAF-002 - 3265mm
	19	Brace
	20	Purlin (2 variants) 2490mm long 3490mm long
	21	Common Joiner
	22	Extender Joiner
	23	Unistrut Cross Brace
	24	End Caps

Note – Delivered items must be checked off within 3 days of delivery.
Any claimants of shortages or damages must be raised with this period.

INSTALLATION DIRECTIVES

The below must be followed as a minimum.

1. It is preferred that the panel clamping commences from east to west, unless to site conditions require it to be done west to east.
2. The panels are to be fixed at the row ends using end clamps, and using top hat clamps in mid positions.
3. All panel clamps will be fixed to the purlins using sliding clamps.
4. For Pile embedment depth, ballast plate loadings, bay spacings and all other dimensions see framework drawings.
5. Panel clamps on the 1st purlins shall be fixed using swing nuts and cap head bolts, tightened from the front (south side) of the array.
6. Panel clamps on the 2nd, 3rd & 4th purlins shall be fixed using hex bolts and hex nuts, tightened from the underneath of the array (accessed from the north side).
7. Only Bolts, Nuts and Washers supplied by Solarport are to be used.
8. Any cutting or drilling of the system, other than unistrut braces, will invalidate the warranty.

TOOLING GUIDANCE

Tooling to be supplied by the installer. Solarport Systems are a supply only manufacturer and do not supply any tooling for installation.

REQUIRED TOOLS	SIZE
Combi Spanner	19mm (M12) and 13mm (M8)
Socket Set and Sockets	19mm (M12) and 13mm (M8)
Torque Wrench to suit Sockets	-
String Line	-
Tape Measure	-
Boat Level – Digital Level	-
Allen Key	Size 6 (M8)

Tooling required for the installation; quantity of tooling not specified.

GENERAL OVERVIEW

The panels will be installed in the portrait orientation, two panels high.

The purlins are manufactured as a 'C-section' with the open-edge facing North to facilitate cable management.

The system has a twin post setup, with a separate pile and upright. The open face of the upright is to face east.

SYSTEM OVERVIEW

In the northern hemisphere your solar panels want to be facing south. As a result, all our illustrations shown here are with the system facing south.

The Modular System is constructed with a series of upright assemblies, connected by Purlins. The Upright Assembly consists of two Ground Mounts, be they driven Piles, Ballasted, X-Anchor or Spirafix (see pages 18-20). There is a Front Upright (17) and a Rear Upright (17) which are bolted to the Ground Mount. A Rafter (18) sits on top and joins the two uprights, forming the angle of the system which has a Brace (19) attached to the rear upright. Finally, the upright assemblies are connected by use of Purlins (20) which run at right-angles to the rafter. The purlins are joined together using a Joiner Bracket (21) or an Extender Joiner (22). Finally, pairs of cross-braces (23) are used to strengthen the system.

The system offers two Purlin lengths; 2490mm and 3490mm.

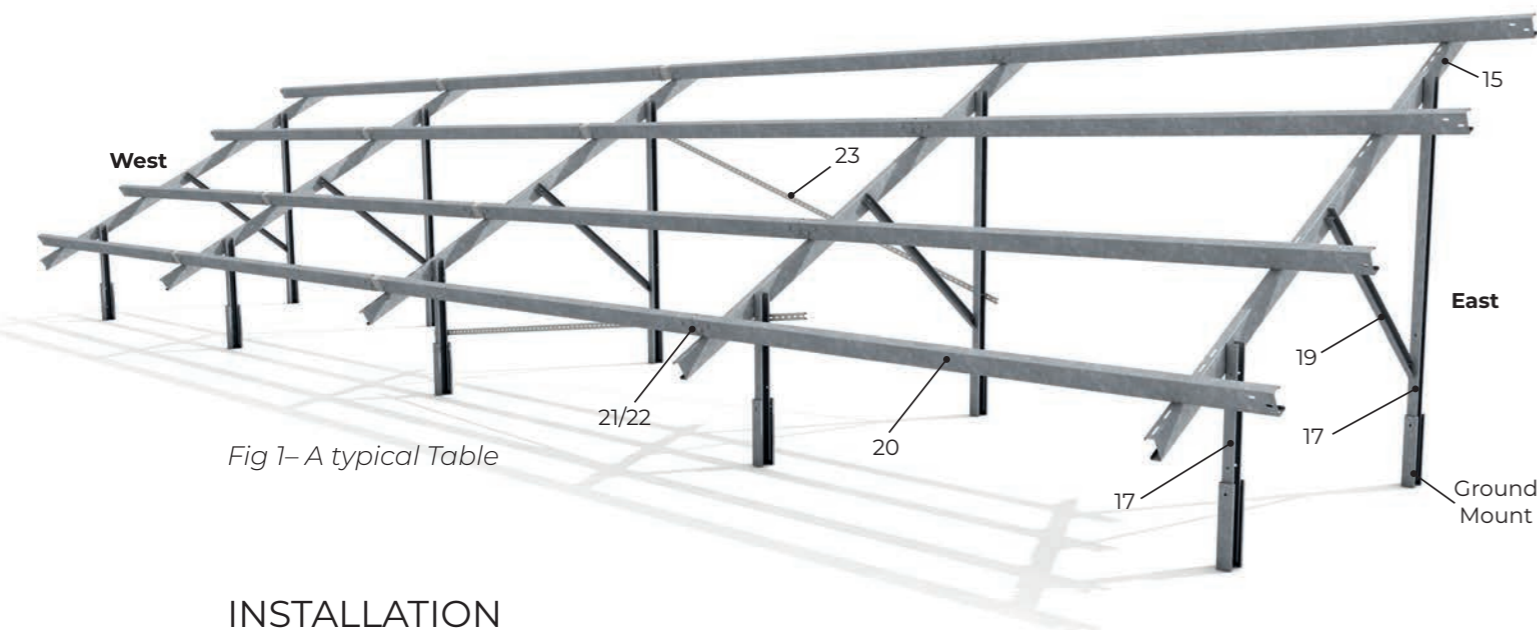

INSTALLATION

GENERAL

The system has been designed to be installed on an even surface, with no sudden drops, and does not allow for physical breaks in the system to allow for relief on uneven ground. Each row position should be taken from the front ground mount/upright.

TERMINOLOGY

Row	A Row is a line of Tables, not connected to one another
Table	Tables are a series of Bays connected by Purlins to form a single unit
Bay	Bays are the spaces between Uprights
Uprights	The combination of ground mount, upright (14), brace (16) and rafter (15)
Pitch	Spacing between upright assemblies

SETTING OUT

See site specific drawings for dimensions. To avoid accumulative errors, all setting out must take place from a single starting datum point. The start of the row and reset gaps/system breaks are acceptable datum points. Ground Mount placement tolerance: +/-30mm (in any direction, from the alignment point).

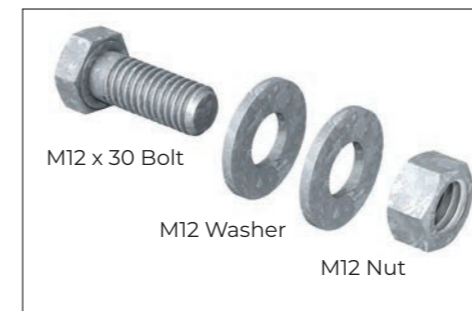

Upright Assembly connections



Take all setting out points from here

Fig 2- Setting out datum point

Assembly should always start from the east, so the first bay on the east end will always be 2,000mm or 3,000mm and the last bay on the west end will always be 2,000mm or 3,000mm - 2,100mm or 3,100mm if Extender Joiner (22) is used.

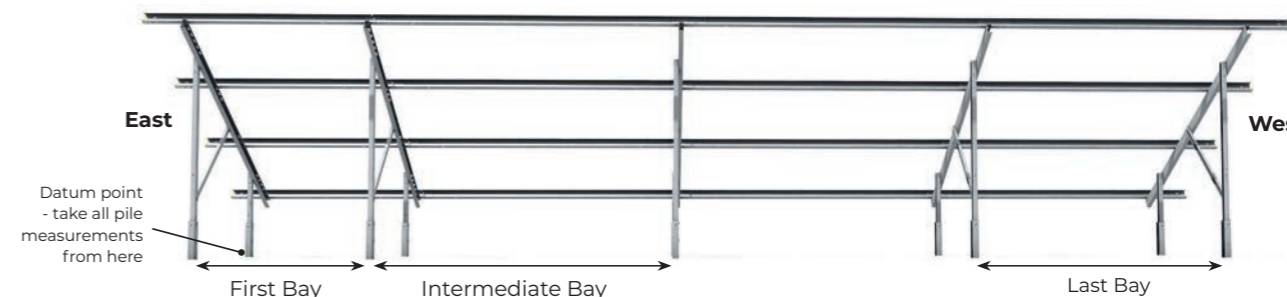

Fig.3 - Setting out (viewed facing south)

FRAME ASSEMBLY METHODOLOGY

The following instructions should have all fixings hand tight to allow for further adjustment once the basic structure has been assembled. Once framework assembly is completed, torque up to the following requirements before panelling. All parts are detailed on pages 4-6.

Note: Diagrams are for reference only and may differ from actual site-specific parts, all components however will operate in the same manor. Bolts depicted in diagrams are for reference only and can be inserted from either direction.

TORQUE SETTINGS	
M12 Bolts	80Nm minimum
M8 Bolts	16-20Nm (For panel clamp torque settings check manufacture installation manual for exact requirement)

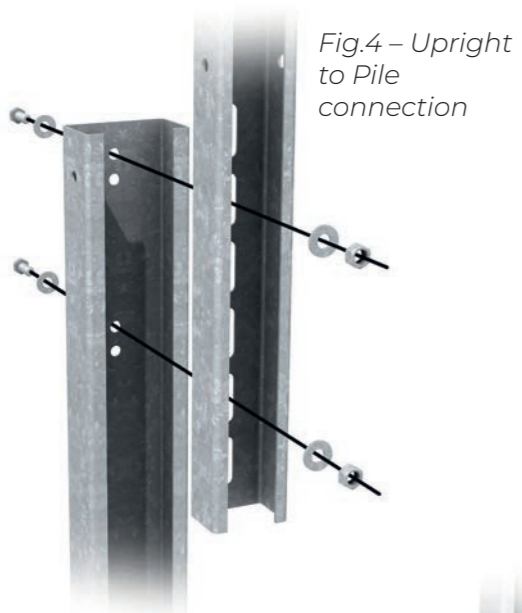

Fig.4 – Upright to Pile connection



Fig.6 – Upright to X-Anchor connection

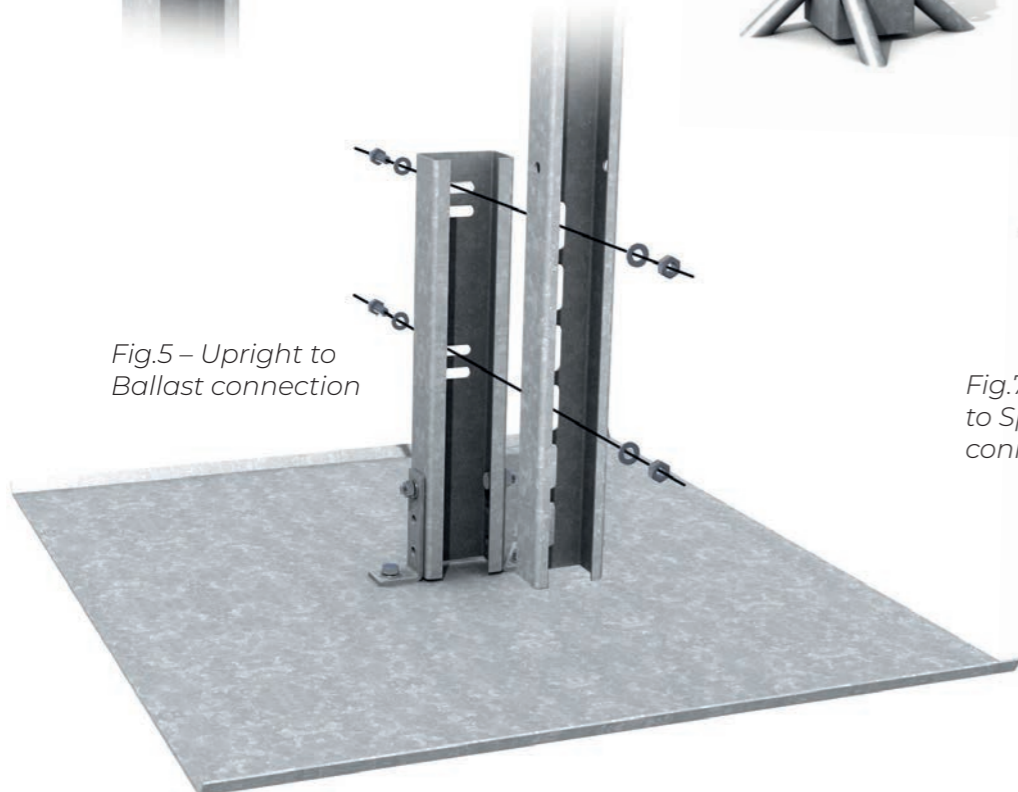

Fig.5 – Upright to Ballast connection

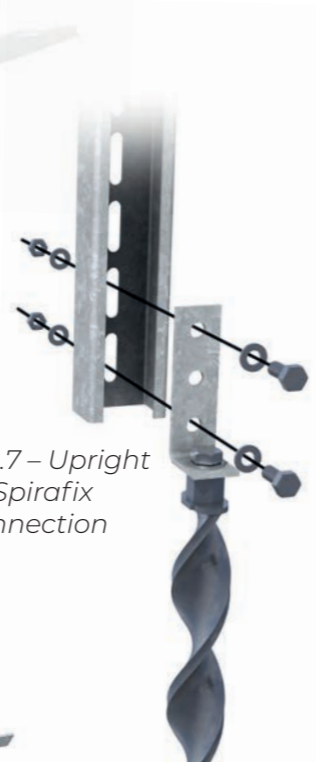

Fig.7 – Upright to Spirafix connection

STEP 1 – A-FRAME ASSEMBLY

Note: The system is designed for tables that can accommodate a minimum of 4 panels (2 x 2) and a maximum of 60 panels (30 x 2)

- a) Assemble the Front Upright to the ground mount using 2 off M12 x 30 bolts, with 2 off M12 nuts and 4 off washers. Repeat for Rear Upright.
- b) Assemble the Rafter (18) to the Front Upright (17) and Rear Upright (17) using 2 off M12 x 30 bolts, with 2 off M12 nut and 4 off washers.
- c) Assemble the Brace (19) onto the Rear Upright and Rafter, using 2 off M12 x 30 bolts, with 2 off M12 nuts and 4 off washers per brace. Ensure the correct slot and hole configuration is being used as per Solarport Systems site specific drawings. This is now one completed Upright Assembly.

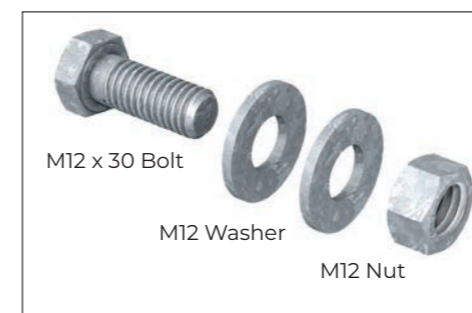

Fig.8 – Rafter to Upright and Brace to rafter/ upright connection detail

STEP 2 – PURLIN

For each 'bay' a total of 4 Purlins are required. A 10mm gap is required between purlins. The open face of the Purlin C-section is to be facing North.

a) At the start of a row, place and fix the first Purlin with 1 off M12 x 30 bolt, 1 of M12 nut and 2 of washer to the pre positioned holes in the rafter. The Purlin is designed to have a 450mm approx. overhang at the start and end of each row. Use the array of slots to best position the purlins so they land within the panel manufacturers clamping zone. Typically you will have a 100mm clamping zone to work within and so you should be able to align purlins with slots in the rafter.

(See **Step 4 - Panel Fixing** on page 13.)



b) Slide the end of the joiner into the end of the purlin which is fixed on the rafter. Fix the purlin and joiner onto the Rafter using 3 off M12 x 30 bolts, M12 nuts and 6 washers.

Repeat this for the next three purlins in that bay. **See Step 4 - Panel Fixing** on page 13. for guidance.

c) The next set of purlins for the next bay will now slot onto the purlin joiners. Align the holes in the purlins and purlin joiners. Fix using 3 off M12 x 30 bolts, with 3 of M12 nuts and 6 washers, per joiner. A 10mm gap is required between the purlins, unless unachievable due to ground undulation.

d) Continue this process along the array.

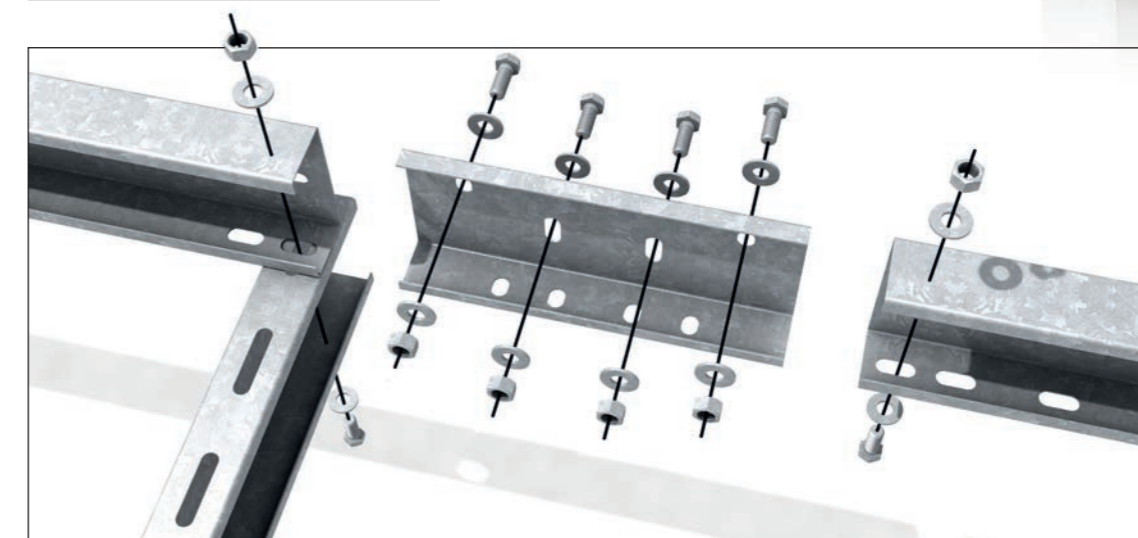
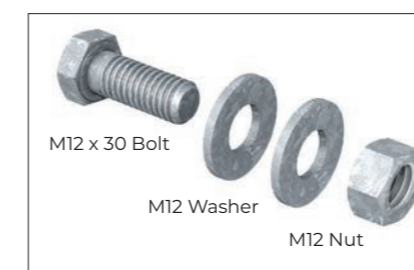

JOINER OPTIONS

There are two Joiner options, our Standard Joiner (21) and an Extender Joiner (22). Some panel widths may result in a table that is slightly too short. The addition of the extender joiner offers an additional 100mm to extend the table - use as many as deemed necessary.

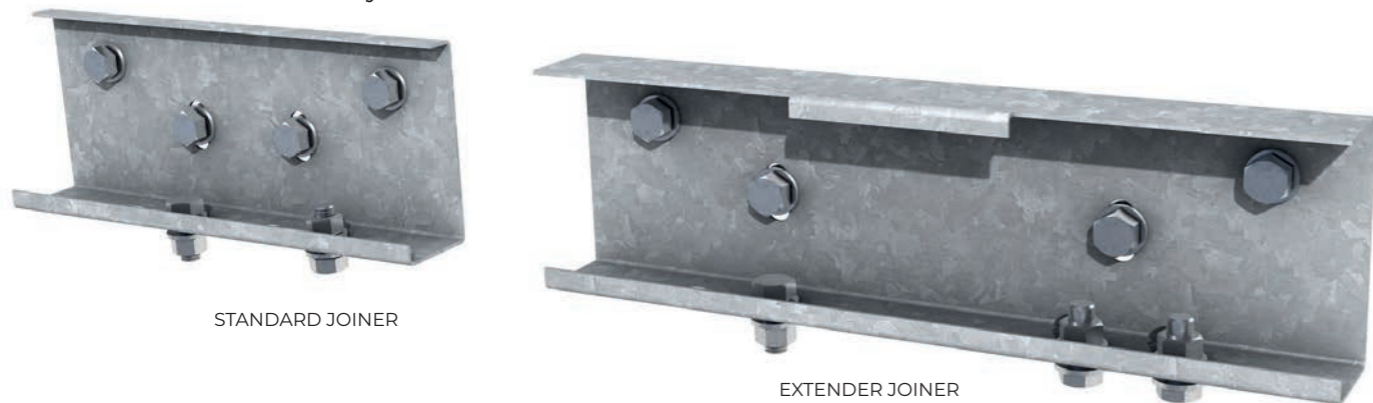

The gaps between purlins should be 10mm with Standard Joiners, and 110mm with Extender Joiners.

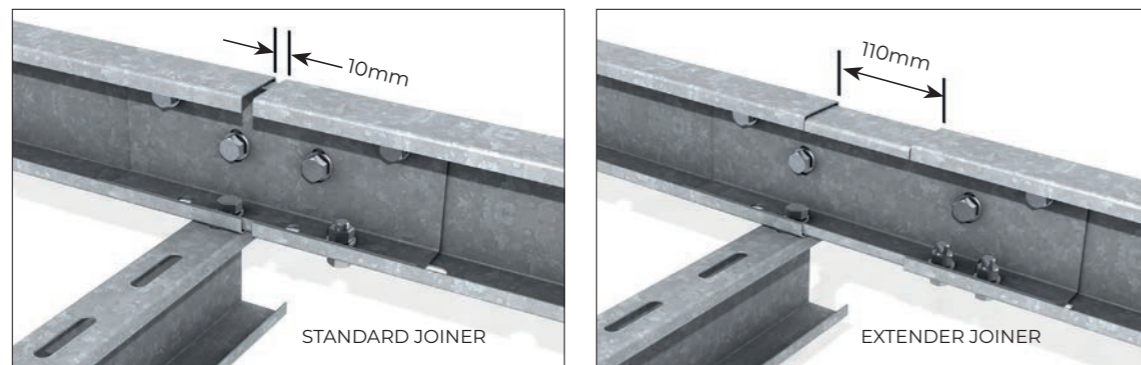

STEP 3 – SQUARING WITH CROSS BRACES

Ballasted and Spirafix Systems

Where required, fit Cross Braces (23) to the system as per the drawings supplied. On Ballasted and Spirafix systems braces must be installed two in each bay in an 'x' configuration - one brace between the rear uprights and one at an opposing angle between the front uprights. Fix using 2 off M12 x 30 bolts, 2 off M12 nuts, and 4 off washers.



Fix the braces to the uprights using the first brace slot on the lower fixing to the upright (see Fig 10) and cut the braces to suit at the opposite end. There are some obvious clashes (see Fig 9), but most others cuts are for aesthetic reasons. When cutting braces, only cut with a hacksaw and finish the cut with a 95% zinc-rich paint. All swarf and debris must be removed prior to zinc paint treatment.

On 20 degree systems there will be some unavoidable brace clashes with the ballast blocks, so where necessary, simply turn the effected block onto it's side.

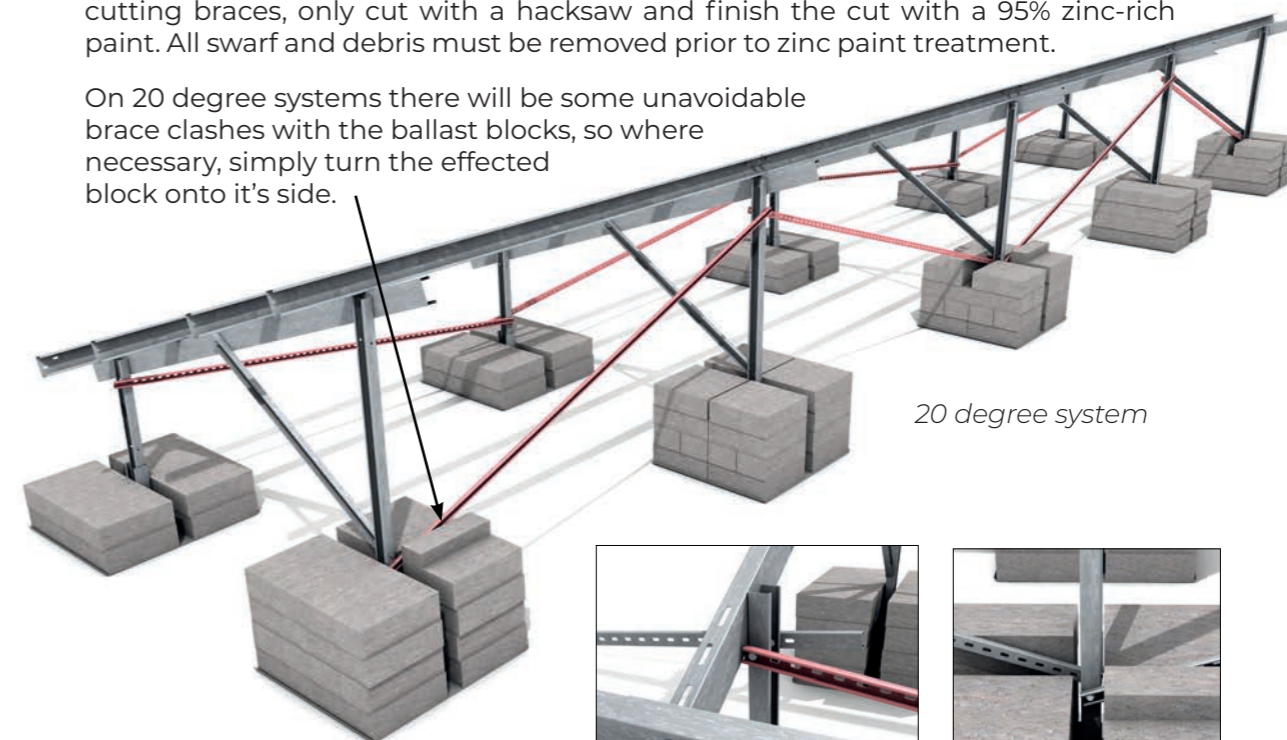

Piled and X-Anchor Systems

Piled and X-Anchor systems only require one bay to have a pair of braces, also in an 'x' configuration, one on the front upright, and one on the rear upright set at opposing angles. These should be on the bay that is either in the centre, or as close to the centre of the table.

STEP 4 – PANEL FIXING

Panelling can commence only when the frame is squared and fully tightened to the required torque settings. Panelling should commence from east to west. All panel clamps and fixings will come pre-assembled, the diagrams below are for representative purposes only.

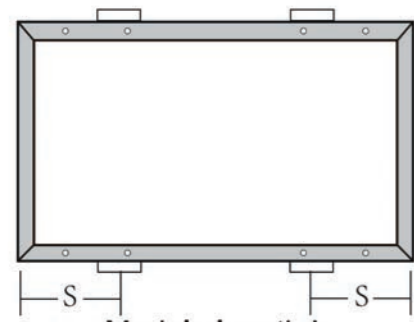

Module length L
Mounting by clamps ($S=1/4L\pm 50$)

Fig.11 – Typical panel clamping zone

Your choice of panel will have an effect on the position of the purlins. Please ensure your purlin spacing is correct before attempting to fit the panels. Each panel manufacturer will have their own specific positions where clamps that attach the panels to the purlins may be fitted, called the 'clamping zone'. Fig. 7 is a typical instruction telling you that the clamping zone centre is inset one-quarter the panel length from the end, and has 50mm either side, giving a total clamping zone of 100mm. You will have room to position the clamps within this clamping zone to achieve alignment with the slots on the rafter.

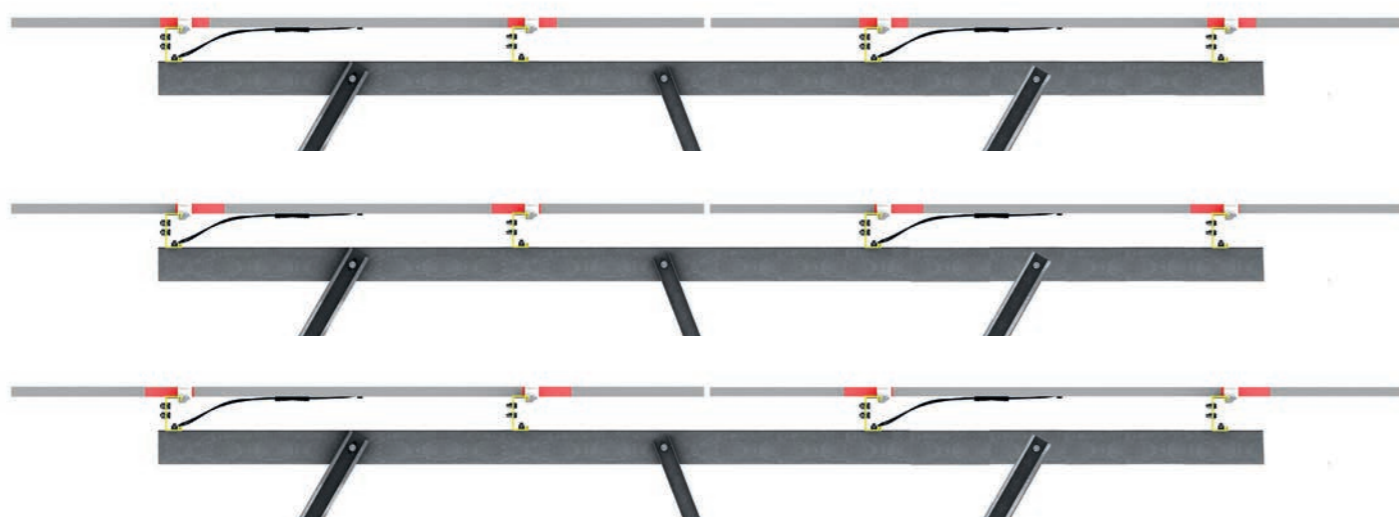

Panel clamps can sit anywhere within the clamping zone, to suit alignment with slots on rafter

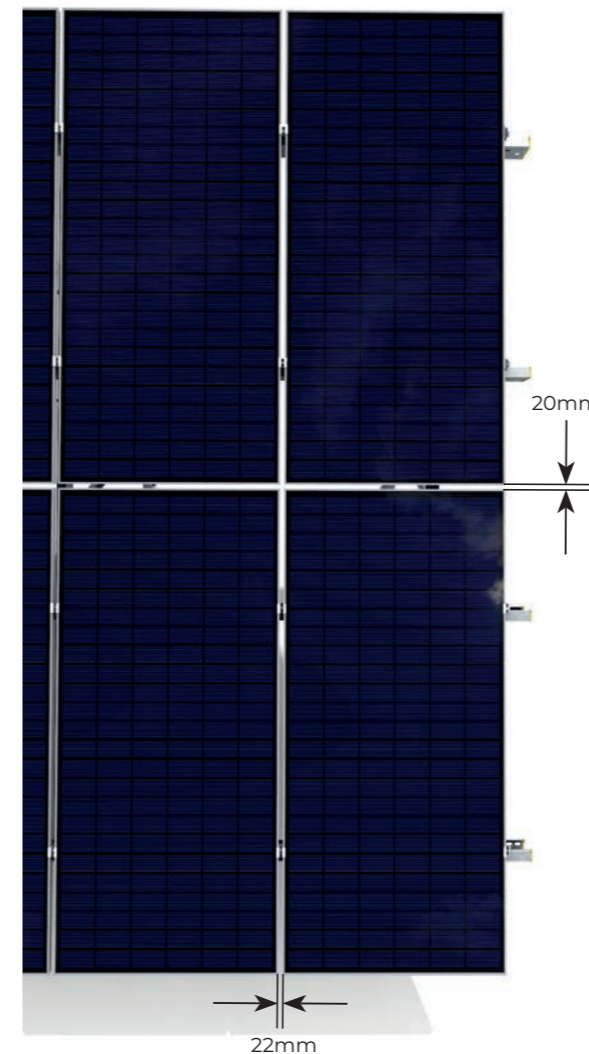

a) Position panels; orientation - portrait. The clamps must be tightened with the north-south panel gap starting at 20mm between the short edge of the panels, variation in this spacing will occur as panelling commences. This 20mm may also be affected by the purlin alignment to slots in the rafter, but should be no less than 20mm as a starting point. The long edge to long edge panel distance is typically 22mm.

b) Position end clamps and sliding clamps along the edge of the first panel row. Position the first row of clamps a minimum of 50mm in from the end of the purlin to the edge of the sliding clamp. Bolt to the purlins using M8 cap head bolts and swing nuts on the 1st purlin, and fix using M8 bolts, washers, and nuts for the 2nd, 3rd and 4th purlins. Push panel firmly into clamp to ensure a good fit.

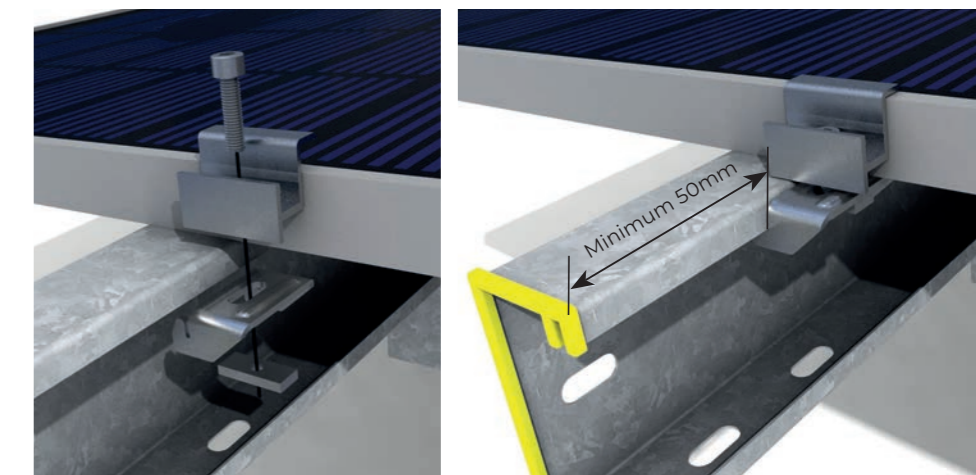

Fig.12– End clamp install (caphead & swingnut shown)

c) Position mid-clamps and sliding clamps between panels Bolt to the purlins using M8 cap head bolts [and swing nuts on the 1st purlin, and fix using M8 bolts, washers, and nuts for the 2nd, 3rd and 4th purlins (See Figure 14).

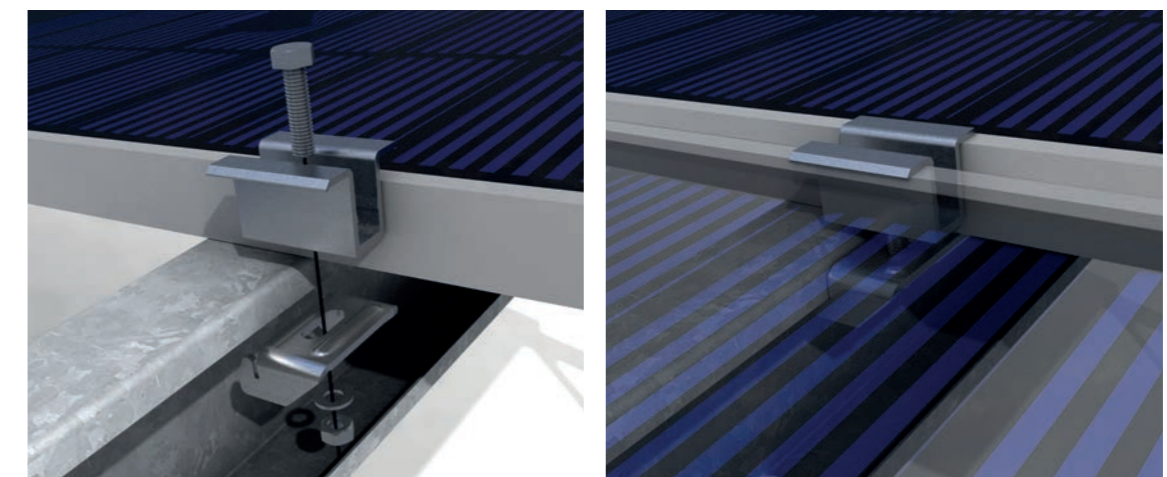

Fig.13 – Mid clamp installation (hex bolt, washer and nut shown)

d) Repeat this process on the rest of the array.

Every effort is made to ensure the system can be fully squared/levelled, but if the panels cannot be kept square, it is highly recommended that the clamps should be fully engaged with the panels. Failure to do so may cause a reduction in structural stability. Solarport will not take responsibility for clamp failure if not installed properly.

Where the sliding clamps sit over purlin gaps, they will allow for the fixing position to move $\pm 7\text{mm}$. Panel clamps on the 1st purlins shall be fixed using M8 cap head bolts and swing nuts, tightened from the front (south side) of the array. Panel clamps on the 2nd, 3rd and 4th purlins will be fixed using M8 bolts, washers, and nuts, tightened from underneath the array (accessed north side).

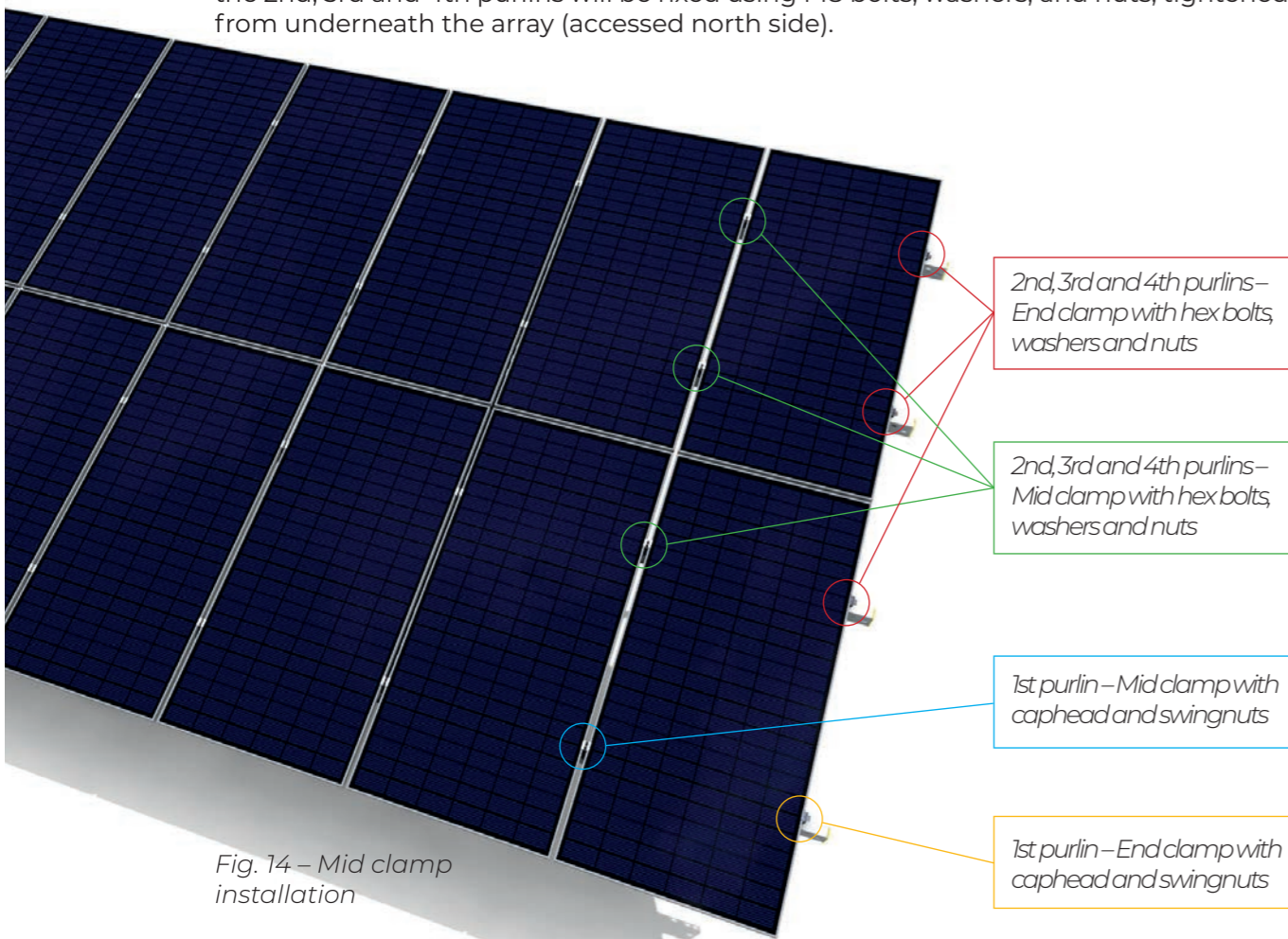
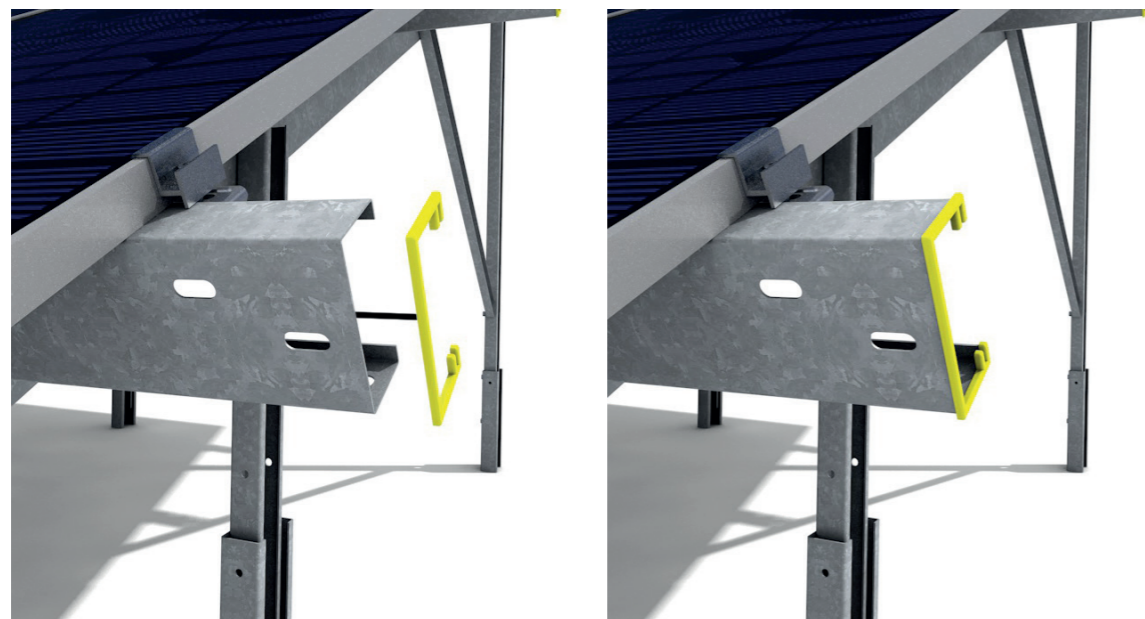

Fig. 14 – Mid clamp installation

STEP 5 – TRIM ASSEMBLY

a) Fit the yellow end caps to the end of the purlins as edge protection, 4 off yellow end caps per end of row. Fit caps on every Table if the ends are accessible, or every row end across site.



PITCHES AND BAYS

The system has been designed to have a defined set of pitches, based on the purlin used. The first and last bays will always be 500mm shorter than the rest.

**There are four potential pitches in use with this system:
2000mm, 2500mm, 3000mm, 3500mm.**

The 2000mm and 3000mm will always be either a start or end bays of the table. If an Extender Joiner is used, add 100mm to these pitches.

PILING CONSIDERATIONS

When piling; the topography of the land should be considered prior to the commencement of work. It is recommended that a string line or laser level should be used as a means for levelling the piles. Do not pile to a direct measurement above the ground, this may lead to uneven pile heights due to the ground undulating.

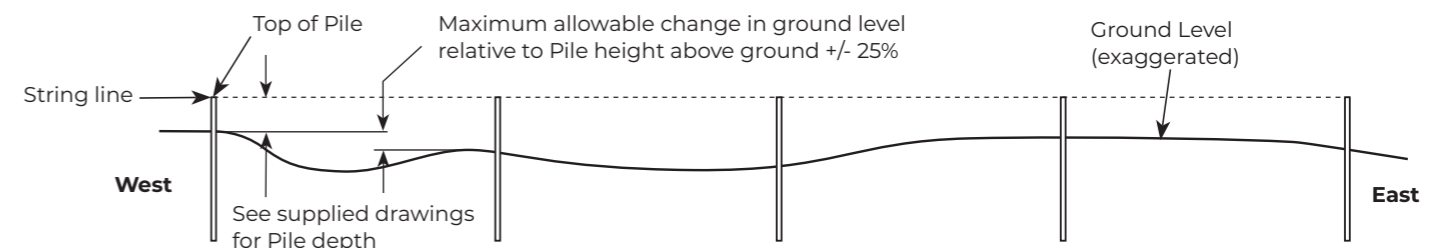
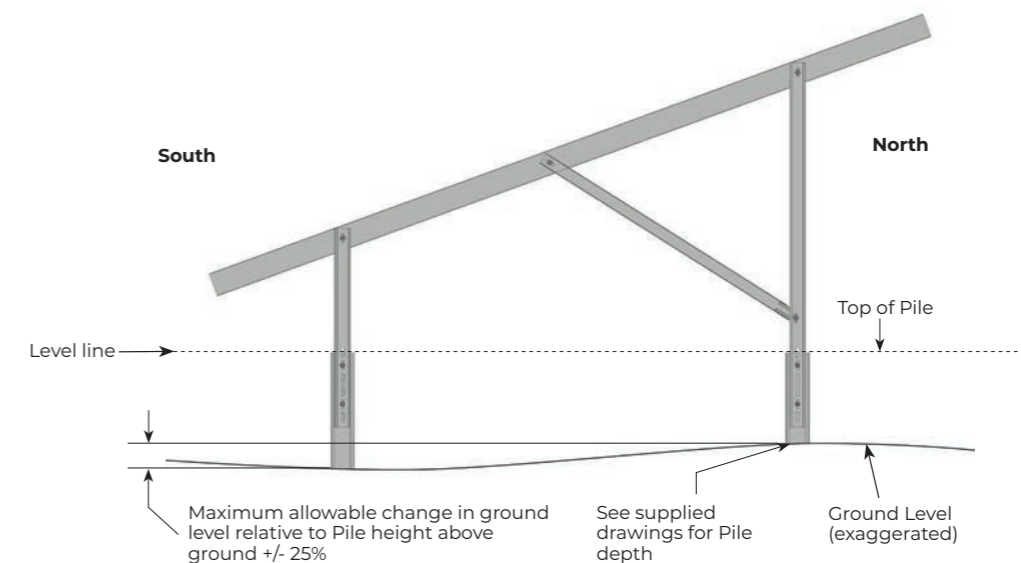

Fig. 15 – Setting out of pile heights

Each row is designed to be seated on ground that can fall or rise on a gradient in the east/west direction. Where the ground gradually slopes, the system should be installed perpendicular with the ground surface, and not perfectly flat. This is to prevent the system elevating further than allowed above the ground, which may cause the foundations to become unstable. Upright extensions may be supplied where there are sudden unforeseen dips in the ground which cause excessive stress in the structure but are not large enough to affect the overall gradient change of the row. In these cases, the request confirmation must be part of the order confirmation.

Tables built on a slope can be reset to allow system to be plum. Once piling of the row is completed and prior to the remaining framework being assembled; all piles must be inspected to ensure they meet all the recommendations as outlined in this section of the document. This is to be undertaken by the installers, and if you have ordered an extended warranty, this will be part of the Solarport sign off procedure.



Pile heights north to south are set out based on the height of the rear pile. Front pile must be at the same height irrespective of ground undulation.

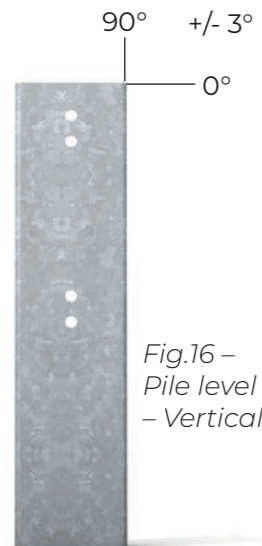

a) Using the installer supplied piling rig, install the 2000mm piles as per Solarport Systems layout drawing and considerations, with an intended 1500mm embedment. There is a shorter 1500mm pile intended for use with an auger and postcrete. Drill a 1000mm deep hole, with 500mm above ground. The open face of the C-section must be facing east. Ensure piles are square in all vertices. The distance between piles (north to south) will be as follows:

20 deg system - 2288mm
25 deg system - 2207mm
30 deg system - 2109mm

When squaring and levelling the piles, it is imperative that it is driven in both levels vertically.

BALLASTED GROUND MOUNT

When ground conditions prevent any penetration the Ballasted Ground Mount provides the solution. The baseplate is loaded with ballast blocks, to prevent the table from moving, the amount being calculated by wind and snow conditions for the site.

Each table is designed to be seated on ground that can fall or rise on a gradient up to a maximum of 6° in the east/west and north/south direction, in total along the length of the table.

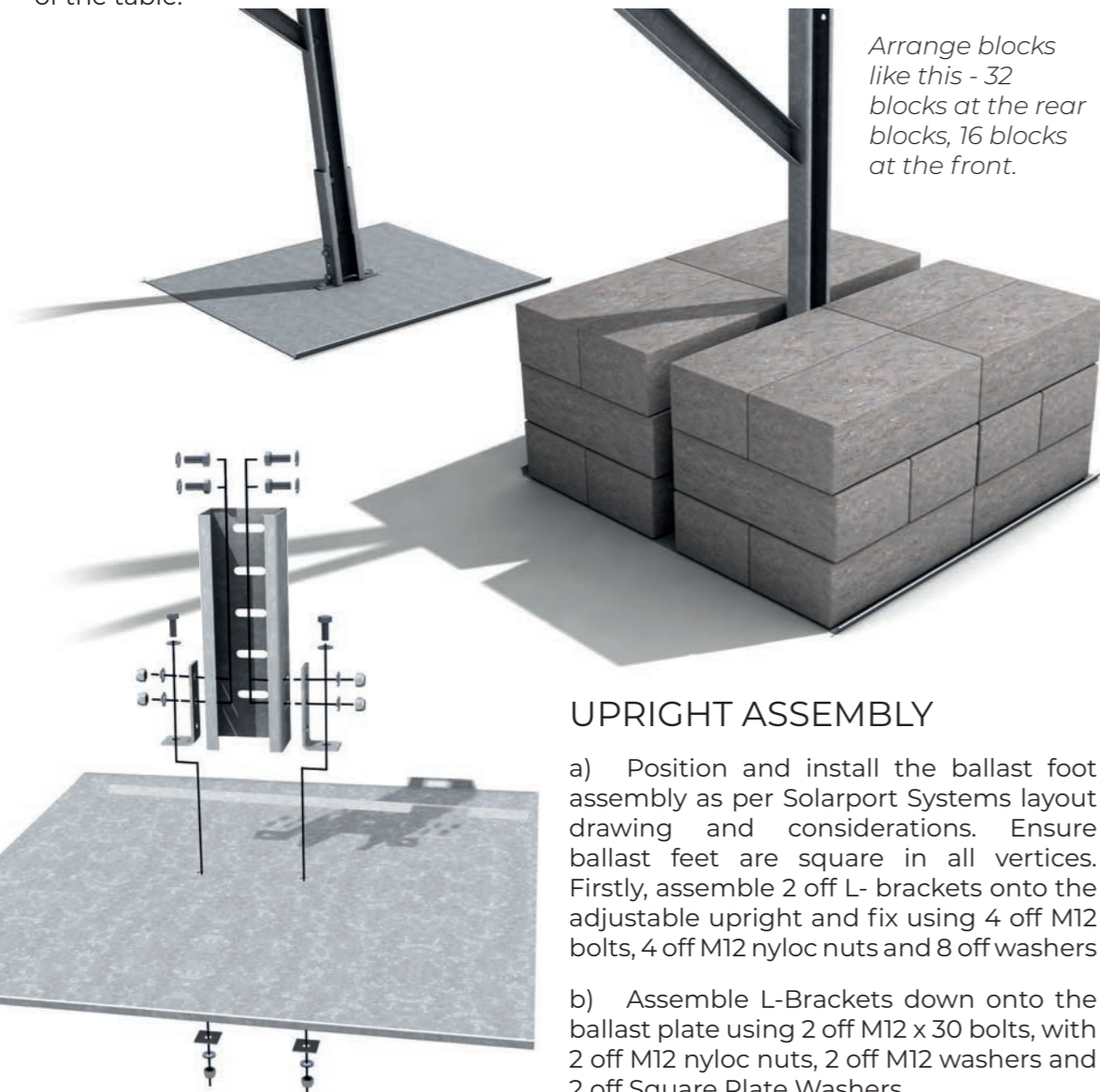

UPRIGHT ASSEMBLY

a) Position and install the ballast foot assembly as per Solarport Systems layout drawing and considerations. Ensure ballast feet are square in all vertices. Firstly, assemble 2 off L- brackets onto the adjustable upright and fix using 4 off M12 bolts, 4 off M12 nyloc nuts and 8 off washers

b) Assemble L-Brackets down onto the ballast plate using 2 off M12 x 30 bolts, with 2 off M12 nyloc nuts, 2 off M12 washers and 2 off Square Plate Washers.

X-ANCHOR GROUND MOUNT

For ground conditions that either have poor soil conditions or do not permit deep penetration, X-Anchor provides the perfect solution.

UPRIGHT ASSEMBLY

a) Position the front and rear x-anchor bodies as per Solarport Systems layout & framework drawings and considerations. The open face of the square sections must be facing east. Ensure x-anchor bodies are square in all vertices and sat fully flat on the ground.

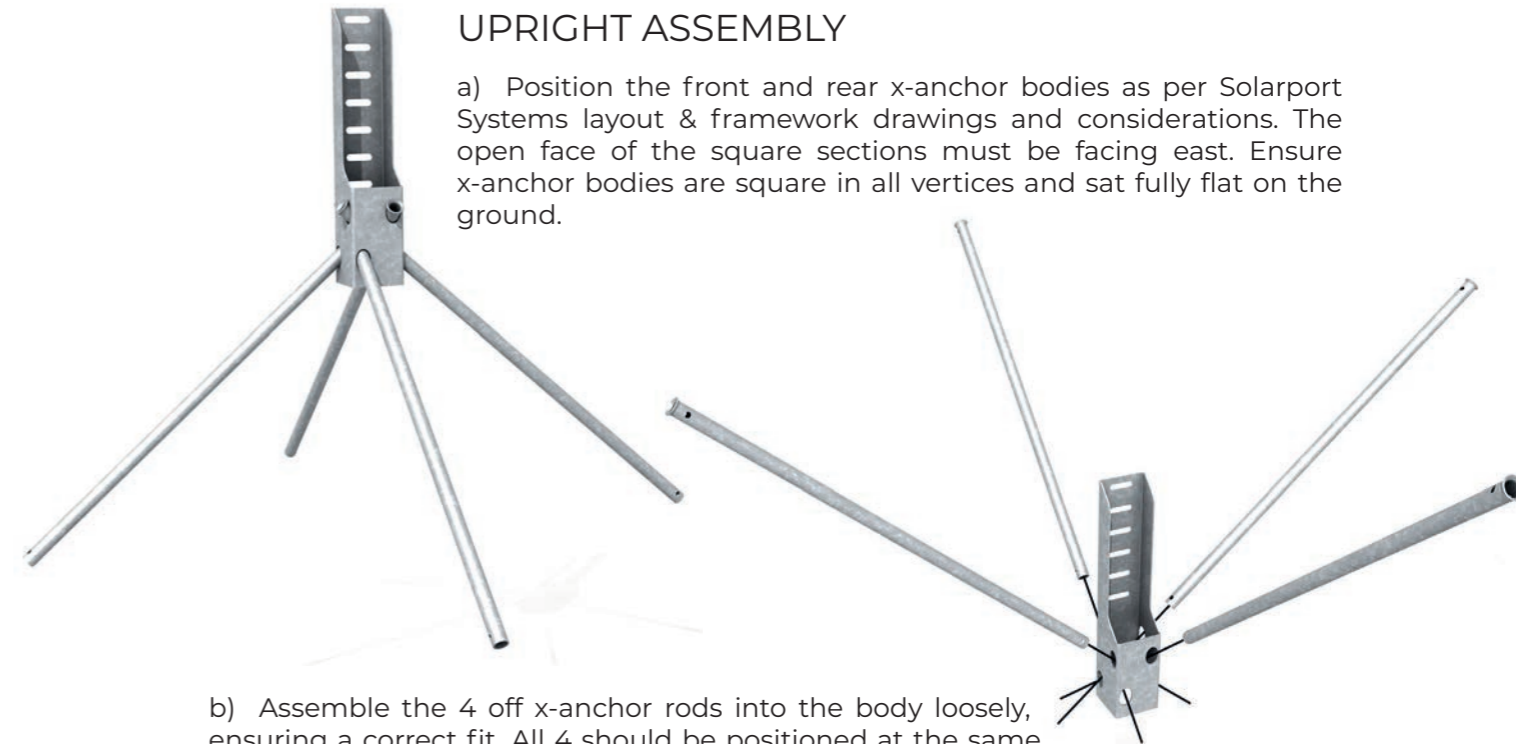

b) Assemble the 4 off x-anchor rods into the body loosely, ensuring a correct fit. All 4 should be positioned at the same time to keep the anchor balanced. Shock the rods into the ground using a Mallet to prevent the x-anchors from moving. Do not fully embed.

This is so the a-frames and purlins can be assembled before the rods are fully embedded, to prevent the x-anchors being installed misaligned.

c) Carry out the rest of steps 2 - 4 before fully driving the rods into the ground using an SDS Max.

SPIRAFIX GROUND MOUNT

When the soil conditions are considered good, Spirafix offer a quick and easy solution as an alternative to piling.

UPRIGHT ASSEMBLY

a) Position the centre of the Spirafix as per Solarport Systems layout & framework drawings and considerations. Using a sledgehammer or lump hammer, along with a manual hammer cap, installation is achieved by impacting the anchor into the ground. We recommend multiple moderate impacts versus heavier larger impacts to allow the anchor to rotate into the ground with each impact. A mechanical post driver could be used if you are competent with this type of device.

Bolt the supplied angle bracket to the top of the Spirafix unit using the supplied bolt. The inner upright face of the bracket must be facing east.



GENERAL GALVANISE CARE

END OF RUN RAILS

Any cutting / drilling of framework must be treated. All debris must be removed prior to treatment.

All areas where the parent metal is visually exposed must be painted (not sprayed) with zinc rich paint. The minimum zinc content of the paint must be or exceed 90%.

GENERAL

Any damage to the galvanised surfaces, sustained during the installation process, must also be treated zinc rich paint.

RECOMMENDATION

Brush on zinc rich products such as Galvafruid are approved paints for treating exposed parent steel.

Ensure any additional Galvanise overlaps the existing layer by 25mm

INSPECTION AND MAINTENANCE RECOMMENDATIONS

GALVANISING

INSPECTION INTERVALS	
Annual	Basic visual / physical inspection along the arrays for movement in joints. Tighten where required
5 Yearly	Full in-depth inspection. All structural fixings to be checked for torque in accordance with original method statements

The galvanising is deemed to decay over the life of the product and has been calculated into the structural integrity of the system. It is therefore not unusual for forms of oxide to be present at the time of inspection. In the main, galvanic / sacrificial reactions will protect rusting surfaces over a period.

FIXINGS

INSPECTION INTERVALS	
Annual	Basic visual / physical inspection along the arrays for movement in joints. Tighten where required
5 Yearly	Full in-depth inspection. All structural fixings to be checked for torque in accordance with original method statements
Major Storm	To be in checked in accordance with annual inspection interval

STRUCTURE

INSPECTION INTERVALS	
Annual	Basic visual / physical inspection along the arrays for localised buckling caused by major storm or human error. Failures to be replaced
5 Yearly	Full in-depth inspection. All components and connections to be inspected for structural fatigue. Failures to be replaced
Major Storm	To be checked in accordance with annual inspection interval. Failures to be replaced

SYSTEM LIMITATIONS

The panels must be fully supported by the purlins; therefore, no panel overhang is allowed on a portrait system.

It is imperative that the distance between two neighbouring bolts for the pile/upright connection or upright/adjustable upright connection is 100mm as a minimum.

Where the topography is too severe to achieve a natural change in direction, the table must be broken, and a new array is to be started adjacent to it. The recommended gap between arrays is 500mm.

CHECKING PROCEDURE

If you have paid for an Extended Warranty, the checking procedure form must be completed in full and emailed to modular@solarportsystems.com prior to a Solarport site visit sign off taking place.

See document 'Form-08.03.07 GM Site Check Form'. This document will be supplied with installation for completion. If document is unavailable, please email us at modular@solarportsystems.com for a copy.

All areas where the parent metal is visually exposed must be painted (not sprayed) with zinc rich paint. The minimum zinc content of the paint must be or exceed 90%.



CONTACT DETAILS:

Email: modular@solarportsystems.com
Phone: +44 (0) 1308 800501

