



Three Phase Inverter with synergy technology Installation Guide

For Europe, APAC, Australia & South Africa
Version 1.1

Disclaimers

Important Notice

Copyright © SolarEdge Inc. All rights reserved.

No part of this document may be reproduced, stored in a retrieval system or transmitted, in any form or by any means, electronic, mechanical, photographic, magnetic or otherwise, without the prior written permission of SolarEdge Inc.

The material furnished in this document is believed to be accurate and reliable. However, SolarEdge assumes no responsibility for the use of this material. SolarEdge reserves the right to make changes to the material at any time and without notice. You may refer to the SolarEdge web site (www.solaredge.com) for the most updated version.

All company and brand products and service names are trademarks or registered trademarks of their respective holders.

Patent marking notice: see <http://www.solaredge.com/patent>

The general terms and conditions of delivery of SolarEdge shall apply.

The content of these documents is continually reviewed and amended, where necessary. However, discrepancies cannot be excluded. No guarantee is made for the completeness of these documents.

The images contained in this document are for illustrative purposes only and may vary depending on product models.

Emission Compliance

This equipment has been tested and found to comply with the limits applied by the local regulations. These limits are designed to provide reasonable protection against harmful interference in a residential installation. This equipment generates, uses and can radiate radio frequency energy and, if not installed and used in accordance with the instructions, may cause harmful interference to radio communications. However, there is no guarantee that interference will not occur in a particular installation. If this equipment does cause harmful interference to radio or television reception, which can be determined by turning the equipment off and on, you are encouraged to try to correct the interference by one or more of the following measures:

- Reorient or relocate the receiving antenna.
- Increase the separation between the equipment and the receiver.
- Connect the equipment into an outlet on a circuit different from that to which the receiver is connected.
- Consult the dealer or an experienced radio/TV technician for help.

Changes or modifications not expressly approved by the party responsible for compliance may void the user's authority to operate the equipment.

Contents

Disclaimers	1
Important Notice	1
Emission Compliance	1
Support and Contact Information	5
HANDLING AND SAFETY INSTRUCTIONS	7
Safety Symbols Information	7
IMPORTANT INVERTER SAFETY INSTRUCTIONS	7
Chapter 1: Introducing the SolarEdge Power Harvesting System	9
SolarEdge Power Optimizer	9
Three Phase Inverter with synergy technology	10
SolarEdge Monitoring Platform	11
Installation Procedure	11
Installation Equipment List	11
Chapter 2: Installing the Power Optimizers	13
Safety	13
Installation Guidelines	13
Step 1: Mounting the Power Optimizers	14
Step 2: Connecting a PV Module to a Power Optimizer	15
Step 3: Connecting Power Optimizers in Strings	15
Step 4: Verifying Proper Power Optimizer Connection	17
Chapter 3: Installing the Primary and Secondary Unit(s)	18
Primary Unit Package Contents	18
Secondary Unit Package Contents	18
Identifying the Units	18
Primary Unit Interface	18
Connection Unit Interface	21
Secondary Unit Interface	22
Mounting and Connecting the Primary and Secondary Unit(s)	23
Chapter 4: Connecting the AC and Strings to the Connection Unit	29
Grid Connection Guidelines	29
Connecting the AC Grid to the Connection Unit	29
Connecting the AC Grid and Grounding to the Connection Unit	30
Grounding	30
Secondary Grounding	31
Connecting the Strings to the Connection Unit	32
Selecting a Residual Current Device (RCD)	34
Chapter 5: Activating, Commissioning and Configuring the System Using SolarEdge Inverter SetApp	35
Step 1: Activating the Installation	35
Step 2: Commissioning and Configuring the Installation	36
Setting Country and Language	38
Pairing	38
Communication	40
Power Control	41

Maintenance	43
Information	45
Step 3: Verifying Proper Activation and Commissioning	46
Reporting and Monitoring Installation Data	46
The SolarEdge Monitoring System	46
Providing Installation Information	47
Site Mapper Application	47
Creating a Site in the SolarEdge Monitoring Platform	48
Paper Template	48
Viewing System Status	48
Main Inverter Status	49
Multiple Inverters Status	50
Communication Status	51
Inverter Energy Status	52
Meter Status	52
Chapter 6: Setting Up Communication	54
Communication Options	55
Ethernet	55
RS485	55
Wi-Fi	55
GSM	55
Communication Connectors	56
Communication Board	57
Primary Unit Communication Board	57
Connection Unit Communication Board	58
Removing the Connection Unit Cover	58
Creating an Ethernet (LAN) Connection	58
Creating an RS485 Bus Connection	61
RS485 Bus Configuration	64
Verifying the Connection	65
Appendix A: Errors and Troubleshooting	67
Identifying Errors	67
Power Optimizer Troubleshooting	70
Troubleshooting Communication	71
Troubleshooting Ethernet (LAN) Communication	71
Troubleshooting RS485 Communication	71
Additional Troubleshooting	71
Appendix B: Mechanical Specifications	73
Primary Unit and Connection Unit	73
Secondary Unit	73
Appendix C: SafeDC™	74
Appendix D: External Fan Maintenance and Replacement	75
Fan Maintenance	75
External Fan Replacement	75

Appendix E: Replacing System Components	77
Replacing the Primary Unit	77
Replacing a Secondary Unit	78
Replacing the Connection Unit	78
Removing the Connection Unit	78
Installing a New Connection Unit	79
Connecting the Connection Unit to the Primary Unit	79
Replacing Power Optimizers	80
Technical Specifications	82

Support and Contact Information

If you have technical problems concerning SolarEdge products, please contact us:

Country	Phone	E-Mail
Australia (+61)	1800 465 567	support@solaredge.net.au
APAC (Asia Pacific)(+972)	073 240 3118	support-asia@solaredge.com
Benelux	NL (+31): 0800-7105 BE (+32): 0800-76633	support@solaredge.nl support@solaredge.be
China (+86)	21 6212 5536	support_china@solaredge.com
DACH & Rest of Europe (+49)	089 454 59730	support@solaredge.de
France (+33)	0800 917410	support@solaredge.fr
Italy (+39)	0422 053700	support@solaredge.it
Japan (+81)	03 6262 1223	support@solaredge.jp
New Zealand (+64)	0800 144 875	support@solaredge.net.au
US & Canada (+1)	510 498 3200	ussupport@solaredge.com
United Kingdom (+44)	0800 028 1183	support-uk@solaredge.com
Greece (+49)	89 454 59730	support@solaredge.com
Israel (+972)	073 240 3122	
Middle East & Africa (+972)	073 240 3118	
South Africa (+27)	0800 982 659	
Turkey (+90)	216 706 1929	
Worldwide (+972)	073 240 3118	

Before contact, make sure to have the following information at hand:

- Model and serial number of the product in question.
- The error indicated on the SolarEdge Inverter SetApp mobile applicationscreen or on the SolarEdge monitoring platform or by the LED, if there is such an indication.
- System configuration information, including the type and number of modules connected and the number and length of strings.
- The communication method to the SolarEdge server, if the site is connected.
- The inverter software version as appears in the ID status screen.

Version History

- Version 1.1 (May 2018) - Changed inverter name to Three Phase Inverter with synergy technology
- Version 1 (December 2017)

HANDLING AND SAFETY INSTRUCTIONS

During installation, testing and inspection, adherence to all the handling and safety instructions is mandatory. **Failure to do so may result in injury or loss of life and damage to the equipment.**

Safety Symbols Information

The following safety symbols are used in this document. Familiarize yourself with the symbols and their meaning before installing or operating the system.



WARNING!

Denotes a hazard. It calls attention to a procedure that, if not correctly performed or adhered to, could result in **injury or loss of life**. Do not proceed beyond a warning note until the indicated conditions are fully understood and met.



CAUTION!

Denotes a hazard. It calls attention to a procedure that, if not correctly performed or adhered to, could result in **damage or destruction of the product**. Do not proceed beyond a caution sign until the indicated conditions are fully understood and met.



NOTE

Denotes additional information about the current subject.



IMPORTANT SAFETY FEATURE

Denotes information about safety issues.

Disposal requirements under the Waste Electrical and Electronic Equipment (WEEE) regulations:



NOTE

Discard this product according to local regulations or send it back to SolarEdge.

IMPORTANT INVERTER SAFETY INSTRUCTIONS

SAVE THESE INSTRUCTIONS



WARNING!

The inverter cover must be opened only after shutting off the inverter ON/OFF switch located at the bottom of the Primary Unit, above the Connection Unit. This disables the DC voltage inside the inverter and opens the AC relays. Wait five minutes before opening the cover. Otherwise, there is a risk of electric shock from energy stored in the capacitors.

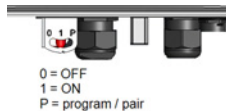

WARNING

Before operating the inverter, ensure that the inverter is grounded properly.



WARNING!

Opening the inverter and repairing or testing under power must be performed only by qualified service personnel familiar with this inverter.



WARNING!

Do not touch the PV panels or any rail system connected when the inverter switch is ON, unless grounded.



WARNING!

SafeDC complies with IEC60947-3 when installing the system with a worst case SafeDC voltage (under fault conditions) < 120V.

The worst case voltage is defined as: $V_{oc,max} + (\text{String Length} - 1) * 1V$, where:

- $V_{oc,max}$ = Maximum V_{oc} (at lowest temperature) of the PV module in the string (for a string with multiple module models, use the max value)
- String Length = number of power optimizers in the string



CAUTION!

This unit must be operated according to the technical specification datasheet provided with the unit.



CAUTION!

HEAVY OBJECT. To avoid muscle strain or back injury, use proper lifting techniques, and if required - a lifting aid.



NOTE

Use PV modules rated according to IEC 61730 class A.



NOTE

The symbol  appears at grounding points on the SolarEdge equipment. This symbol is also used in this manual.



NOTE

A SolarEdge inverter may be installed in a site with a generator, however must not operate at the same time as the generator. Operating an inverter and a generator simultaneously will void the warranty. SolarEdge requires installing a physical or electronic interlock, which will prevent the generator and inverter from operating simultaneously. Interlock procurement, installation, maintenance and support are the responsibility of the installer. Damage to the inverter due to incorrect interlock installation or use of an interlock that is incompatible with the SolarEdge system will render the SolarEdge warranty invalid.



NOTE

The following warning symbols appear on the inverter warning label:



Risk of electric shock



5 Minutes

Risk of electric shock from energy stored in the capacitor. Do not remove cover until 5 minutes after disconnecting all sources of supply.



Hot surface – To reduce the risk of burns, do not touch.

Chapter 1: Introducing the SolarEdge Power Harvesting System

The SolarEdge power harvesting solution is designed to maximize the power output from any type of solar Photovoltaic (PV) installation while reducing the average cost per watt. The following sections describe each of the system's components.

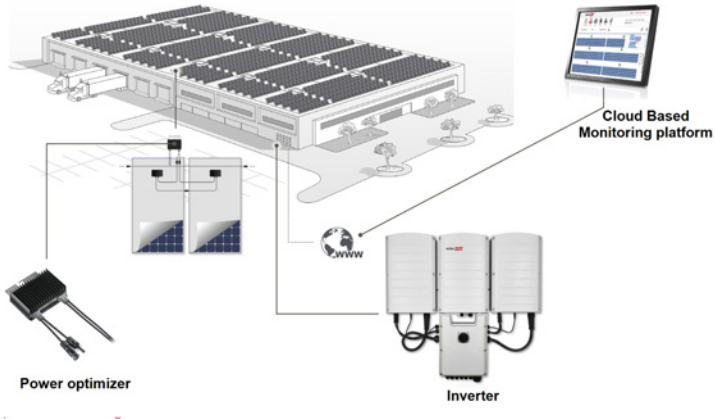

Figure 1: The SolarEdge power harvesting system components

SolarEdge Power Optimizer

The SolarEdge power optimizers are DC-DC converters connected to PV modules in order to maximize power harvesting by performing independent Maximum Power Point Tracking (MPPT) at the module level.

The power optimizers regulate the string voltage at a constant level, regardless of string length and environmental conditions.

The power optimizers include a safety voltage function that automatically reduces the output of each power optimizer to 1 Vdc in the following cases:

- During fault conditions
- The power optimizers are disconnected from the inverter
- The inverter ON/OFF switch is turned OFF
- The safety switch on the Connection Unit is turned OFF
- The inverter AC breaker is turned OFF

Each power optimizer also transmits module performance data over the DC power line to the inverter.

Two types of power optimizers are available:

- Module Add-on power optimizer – connected to one or more modules
- Smart modules - the power optimizer is embedded into a module

Three Phase Inverter with synergy technology

The Three Phase Inverter with synergy technology inverter (referred to as 'inverter' in this manual) efficiently converts DC power from the modules into AC power that can be fed into the main AC service of the site and from there to the grid. The inverter also receives the monitoring data from each power optimizer and transmits it to the SolarEdge monitoring platform (requires Internet or Cellular connection).

The inverter is comprised of one Primary Unit with an integrated Connection Unit with a DC Safety Switch (referred to as 'Connection Unit' in this manual) for disconnecting the DC power of a SolarEdge system, and of one or two Secondary Units, depending on the inverter's capacity. The Secondary Unit(s) are connected to the primary unit with AC, DC and communication cables.

Each unit operates independently and continues to work in case the others are not operating.

You can set up a master-slave configuration, connecting up to 31 additional inverters to one master inverter.

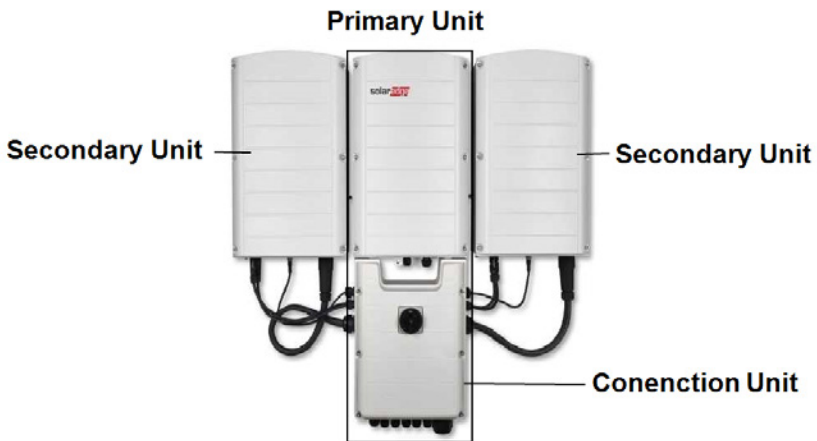

Figure 2: Primary Unit with two Secondary Units

SolarEdge Monitoring Platform

The SolarEdge monitoring platform enables monitoring the technical and financial performance of one or more SolarEdge sites. It provides past and present information on the system performance both at the system and module levels.

Installation Procedure

The following is the procedure for installing and setting up a new SolarEdge site. Many of these also apply to modification of an existing site.

1. [Installing the Power Optimizers](#), page 13
2. [Mounting and Connecting the Primary and Secondary Unit\(s\)](#), page 23



NOTE

It is recommended to connect communication connections (step 6 of this installation) before connecting the AC, for easier access to the communication board.

3. [Connecting the AC and the Strings to the Connection Unit](#), page 29
4. [Activating and Commissioning the System Using SetApp](#), page 35
5. [Configuring the System Using SetApp](#), page 40
6. [Setting Up Communication](#) page 54

Installation Equipment List

Standard tools can be used during the installation of the SolarEdge system. The following is a recommendation of the equipment needed for installation:

- Allen screwdriver for 5mm screw type for the inverter cover, Connection Unit cover, and inverter side screws
- Allen screwdriver for M5/M6/M8 screw types
- 17/32 HEX Allen screwdriver for AC stud connector
- SolarEdge supplied level
- Standard flat-head screwdrivers set
- Non-contact voltage detector
- Cordless drill or screwdriver and bits suitable for the surface on which the inverter will be installed. Use of an impact driver is not recommended.
- Appropriate mounting hardware (for example: stainless bolts, nuts, and washers) for attaching:
 - the Primary and Secondary Unit(s) mounting brackets to the mounting surface
 - the power optimizers to the racking (not required for smart modules)
- MC4 crimper
- 4xM8 ring terminals and a suitable crimper
- Wire cutters
- Wire strippers
- Voltmeter

For installing the communication options, you may also need the following:

- For Ethernet:
 - CAT5/6 twisted pair Ethernet cable with RJ45 connector
 - If using a CAT5/6 cable spool: RJ45 plug and RJ45 crimper

- For RS485:
 - Four- or six-wire shielded twisted pair cable.
 - Watchmaker precision screwdriver set

For secondary grounding:

- Ring terminal crimper for the AC wire
- Ring terminal
- Serrated washer
- Grounding screw
- Two washers

Chapter 2: Installing the Power Optimizers

Safety

The following notes and warnings apply when installing the SolarEdge power optimizers. Some of the following may not be applicable to smart modules:

**WARNING!**

When modifying an existing installation, turn OFF the inverter ON/OFF switch, the Connection Unit and the AC circuit breaker on the main AC distribution panel.

**CAUTION!**

Power optimizers are IP68/NEMA6P rated. Choose a mounting location where optimizers will not be submerged in water.

**CAUTION!**

This unit must be operated according to the operating specifications provided with the unit.

**CAUTION!**

Cutting the power optimizer input or output cable connector is prohibited and will void the warranty.

**CAUTION!**

All PV modules must be connected to a power optimizer.

**CAUTION!**

If you intend to mount the optimizers directly to the module or module frame, first consult the module manufacturer for guidance regarding the mounting location and the impact, if any, on module warranty. Drilling holes in the module frame should be done according to the module manufacturer instructions.

**CAUTION!**

Installing a SolarEdge system without ensuring compatibility of the module connectors with the optimizer connectors may be unsafe and could cause functionality problems such as ground faults, resulting in inverter shut down. To ensure mechanical compatibility of the SolarEdge optimizers' connectors with the PV modules' connectors to which they are connected, use identical connectors from the same manufacturer and of the same type on both the power optimizers and on the PV modules.

**IMPORTANT SAFETY FEATURE**

Modules with SolarEdge power optimizers are safe. They carry only a low safety voltage before the inverter is turned ON. As long as the power optimizers are not connected to the inverter or the inverter is turned OFF, each power optimizer will output a safe voltage of 1V.

Installation Guidelines

- Frame-mounted power optimizers are mounted directly on the module frame, regardless of racking system (rail-less or with rails). For installation of frame-mounted power optimizers, refer to http://www.solaredge.com/sites/default/files/installing_frame_mounted_power_optimizers.pdf.
- The steps in this chapter refer to module add-on power optimizers. For smart modules, start from *Step 3: Connecting Power Optimizers in Strings* on page 15. Also refer to the documentation supplied with the smart modules.
- The power optimizer can be placed in any orientation.



- If connecting more modules than optimizer inputs in parallel, use a branch cable. Some commercial power optimizer models have a dual input.
- Position the power optimizer close enough to its module so that their cables can be connected.
- Make sure to use power optimizers that have the required output conductor length:
 - Minimize the use of extensions between power optimizers, and use only if connection between optimizers in different rows or arrays is required.
 - *Do not* use extension cables between the modules and the power optimizers.
- The minimum and maximum string length guidelines are stated in the power optimizer datasheets. Refer to the SolarEdge Site Designer for string length verification. The SolarEdge Site Designer is available on the SolarEdge website at <http://www.solaredge.com/products/installer-tools/site-designer/>.
- Completely shaded modules may cause their power optimizers to temporarily shut down. This will not affect the performance of the other power optimizers in the string, as long as the minimum number of unshaded power optimizers connected in a string of modules is met. If under typical conditions fewer than the minimum optimizers are connected to unshaded modules, add more optimizers to the string.
- To allow for heat dissipation, maintain a 2.5 cm / 1" clearance distance between the power optimizer and other surfaces, on all sides except the mounting bracket side.

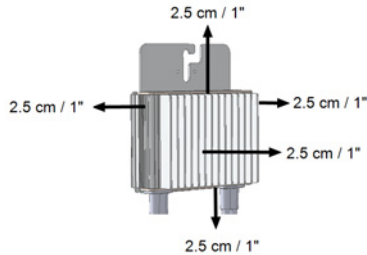

Figure 3: Power optimizer clearance



NOTE

The images contained herein are for illustrative purposes only and may vary depending on product models.

Step 1: Mounting the Power Optimizers

For each of the power optimizers¹:

1. Determine the power optimizer mounting location and use the power optimizer mounting brackets to attach the power optimizer to the support structure. It is recommended to mount the power optimizer in a location protected from direct sunlight. For frame-mounted power optimizers follow the instructions supplied with the optimizers, or refer to https://www.solaredge.com/sites/default/files/installing_frame_mounted_power_optimizers.pdf.



¹Not applicable to smart modules.

- If required, mark the mounting hole locations and drill the hole.



CAUTION!

Do not drill through the power optimizer or through the mounting holes. The drilling vibrations can damage the power optimizer and will void the warranty.

- Attach each power optimizer to the rack using M6 (1/4") stainless steel bolts, nuts and washers or other appropriate mounting hardware. Apply torque of 9.5 N*m / 7 lb*ft.
- Verify that each power optimizer is securely attached to the module support structure.
- Record power optimizer serial numbers and locations, as described in *Reporting and Monitoring Installation Data* on page 46

Step 2: Connecting a PV Module to a Power Optimizer



NOTE

Images are for illustration purposes only. Refer to the label on the product to identify the plus and minus input and output connectors.

For each of the power optimizers:

- Connect the Plus (+) output connector of the module to the Plus (+) input connector of the power optimizer.
- Connect the Minus (-) output connector of the module to the Minus (-) input connector of the power optimizer.

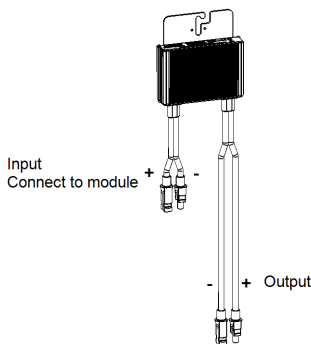

Figure 4: Power optimizer connectors

Step 3: Connecting Power Optimizers in Strings

You can construct parallel strings of unequal length, that is, the number of power optimizers in each string does not have to be the same. The minimum and maximum string lengths are specified in the power optimizer datasheets. Refer to the SolarEdge Site Designer for string length verification.



NOTE

- Use at least 11 AWG/ 4 mm² DC cables.
- The total conductor length of the string (excluding power optimizers' conductors; including home runs and necessary extensions between optimizers) should not exceed:
 - 2300 ft./ 700 m from DC+ to DC- of the inverter

**NOTE**

The DC bus of each unit is separate and not shared for all units. Therefore in addition to following the inverter design rules, each unit should follow the unit design rules as detailed in the Technical Specifications.

1. Connect the Minus (-) output connector of the string's first power optimizer to the Plus (+) output connector of the string's second power optimizer.
2. Connect the rest of the power optimizers in the string in the same manner.

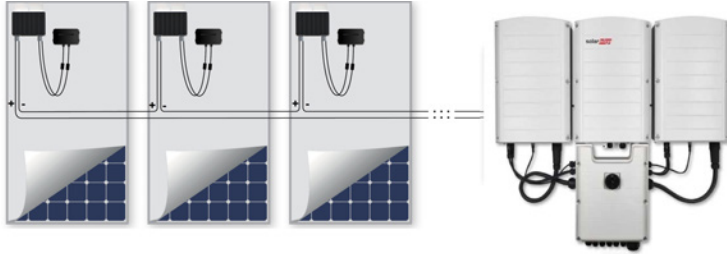

Figure 5: Power optimizers connected in series

3. If you intend to monitor the installation, using the SolarEdge monitoring platform, record the physical location of each power optimizer, as described in *Providing Installation Information* on page 47.

**WARNING!**

Input and output connectors are not watertight until mated. Open connectors should be mated to each other or plugged with appropriate watertight caps.

Step 4: Verifying Proper Power Optimizer Connection

When a module is connected to a power optimizer, the power optimizer outputs a safe voltage of 1V. Therefore, the total string voltage should equal 1V times the number of power optimizers connected in series in the string. For example, if 10 power optimizers are connected in a string, then 10V should be produced.

Make sure the PV modules are exposed to sunlight during this process. The power optimizer will only turn ON if the PV module provides at least 2W.

In SolarEdge systems, due to the introduction of power optimizers between the PV modules and the inverter, the short circuit current I_{SC} and the open circuit voltage V_{OC} hold different meanings from those in traditional systems.

For more information about the SolarEdge system's string voltage and current, refer to the V_{OC} and I_{SC} in *SolarEdge Systems Technical Note*, available on the SolarEdge website at: http://www.solaredge.com/files/pdfs/isc_and_voc_in_solaredge_systems_technical_note.pdf.



► To verify proper power optimizers connection:

Measure the voltage of each string individually before connecting it to the other strings or to the inverter. Verify correct polarity by measuring the string polarity with a voltmeter. Use a voltmeter with at least 0.1V measurement accuracy.



NOTE

Since the inverter is not yet operating, you may measure the string voltage and verify correct polarity on the DC wires inside the Connection Unit.

For troubleshooting power optimizer operation problems, refer to *Power Optimizer Troubleshooting* on page 70.

Chapter 3: Installing the Primary and Secondary Unit(s)

Install the units either before or after the modules and power optimizers have been installed.

First install the Primary Unit, then the Secondary Unit(s) (in any order).



CAUTION!

Do not rest the connectors at the bottom of the units on the ground, as it may damage them. To rest a unit on the ground, lay it on its back.

Primary Unit Package Contents

- Primary Unit (comprised of an inverter and Connection Unit) and pre-assembled cables that connect to the Secondary Unit(s)
- Mounting bracket kit
- Two Allen screws for fastening the unit to the mounting bracket
- Installation guide
- For built-in wireless communication: antenna and mounting bracket
- Level, for marking the mounting brackets' positions
- Cable lock(s)

Secondary Unit Package Contents

- Secondary Unit
- Mounting bracket kit
- Two Allen screws for fastening the unit to the mounting bracket

Identifying the Units

The stickers on the Primary Unit and on the Connection Unit specify the inverter's **Serial Number** and **Electrical Ratings**.

When opening a site in the SolarEdge monitoring platform and when contacting SolarEdge support, provide the inverter's serial number.

Primary Unit Interface

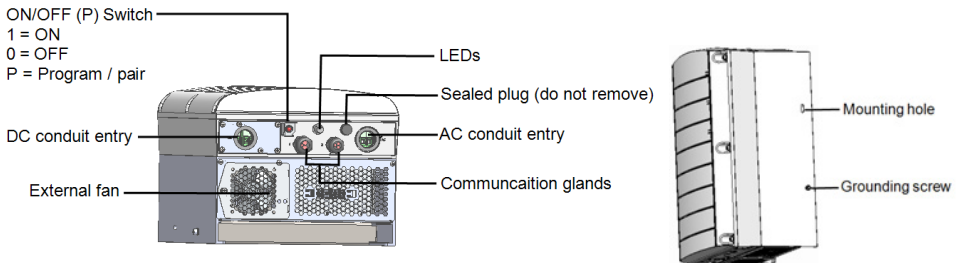

Figure 6: Primary Unit bottom and side interfaces

- **Mounting hole:** for securing the unit to the bracket and for connecting an optional secondary grounding cable.
- **Grounding screw:** for connecting an optional secondary grounding cable.
- **AC and DC conduit entries:** Connection points of the Connection Unit.
- **Two communication glands,** for connection of communication options. Each gland has three openings. Refer to *Setting Up Communication* on page 54 for more information.
- **ON/OFF/P Switch:**

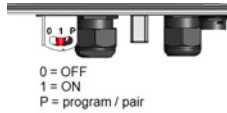

Figure 7: ON/OFF/P switch

- **ON (1)** - Turning this switch ON (after optimizer pairing) starts the operation of the power optimizers, enables power production and allows the inverter to begin exporting power to the utility grid
- **OFF (0)** - Turning this switch OFF reduces the power optimizer voltage to a low safety voltage and inhibits exportation of power. When this switch is OFF, the Primary and Secondary Units' control circuitry remains powered up.
- **P** - Moving and releasing the switch allows viewing system information via the LEDs and on the SolarEdge SetApp mobile application screen and performing functions:

P Position duration	Function	Comments
Switch moved to P for less than 5 seconds , then released.	<ul style="list-style-type: none"> ○ Displays production information for 5 seconds on the SetApp screen. ○ Displays error type indications (if exist) for 5 seconds. ○ Activates the Wi-Fi access point for connecting to the SolarEdge Inverter SetApp 	While the switch is in P, all LEDs are ON
Switch moved to P for more than 5 seconds , then released.	Starts pairing	

- **LEDs:** three LEDs indicate, by color and state (on/ off/ blinking¹/ flickering²/alternating³), different system information, such as errors or performance indications.

Generally, the main LED indications are:

- Blue ON - the inverter is communicating with the monitoring platform
- Green ON - the system is producing
- Green blinking - AC is connected but the system is not producing
- Red ON - system error

¹Blinking = Turns ON and OFF for the same duration

²Flickering = Turns ON for 100 mS and turns OFF for 5 seconds

³Alternating = Alternate LEDs flash

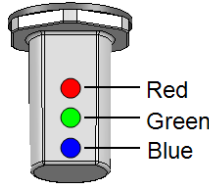

Figure 8: LEDs

The following table describes system performance information by LED color and ON/OFF/P switch position.

Indication	ON/ OFF/ P switch position	LED color			Comment
		Red	Green	Blue	
Power optimizers not paired	ON (1)	OFF	Blinking	<ul style="list-style-type: none"> o S_OK: ON o No S_OK: OFF 	S_OK: ON communication with the monitoring platform is established
Pairing		Blinking	Blinking	Blinking	
Wake-up/ Grid Monitoring		OFF	Blinking	Blinking	
System Producing		OFF	ON	<ul style="list-style-type: none"> o S_OK: ON o No S_OK: OFF 	
Night mode (no production)		OFF	Flickering	<ul style="list-style-type: none"> o S_OK: ON o No S_OK: OFF 	
Inverter is OFF (Safe DC)	OFF (0)	OFF	Blinking	<ul style="list-style-type: none"> o S_OK: ON o No S_OK: OFF 	
Inverter is OFF (DC not safe)		Blinking	Blinking	<ul style="list-style-type: none"> o S_OK: ON o No S_OK: OFF 	
Inverter configuration or reboot	ON / P	ON	ON	ON	
Inverter firmware upgrade	ON / P	Alternating	Alternating	Alternating	The upgrade process can take up to 20 minutes
Error	Any	ON	ON/ OFF/ Blinking/ Flickering	ON/ OFF / Blinking/ Flickering	Refer to <i>Errors and Troubleshooting</i> on page 67

The following table describes production percentage of AC information by LED color and ON/OFF/P switch position.

Indication	ON/ OFF/ P switch position	LED color			Comment
		Red	Green	Blue	
Percentage of AC Production: 0 - 33 %	ON (1)	OFF	ON	OFF	This indicates power production as percentage of rated peak AC output power
Percentage of AC Production: 33 - 66 %		OFF	OFF	ON	
Percentage of AC Production: 66 - 100 %		OFF	ON	ON	

Connection Unit Interface

The Connection Unit is part of the Primary Unit.

There are two types of Connection Units, with MC4 connectors (See Figure 10) or with cable glands for DC connection (see Figure 11

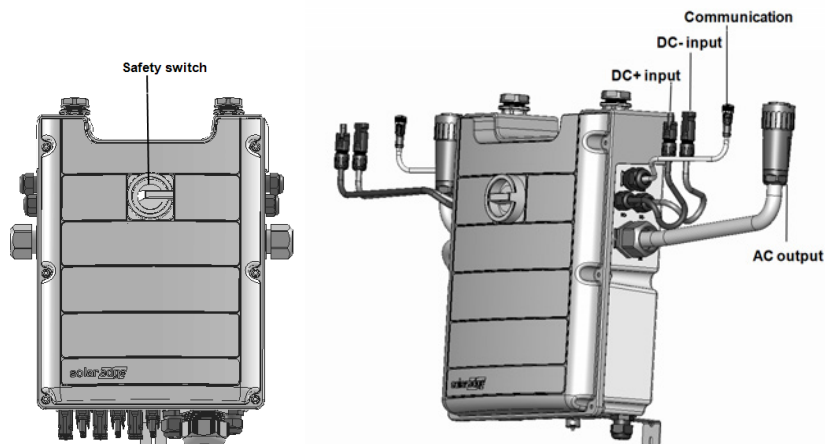

Figure 9: Connection Unit front and side interface

- **Safety Switch:** a manually operated safety switch for disconnecting the DC power of the SolarEdge system.
- Cables for connection to the Secondary Unit(s):
 - Communication cable
 - DC Cable
 - AC Cable
- **DC input:** MC4 connectors / cable glands: for DC+/- connection of the PV installation, there are 3 glands / 6 MC4 connectors for each unit. Each gland has 3 openings to support three strings:
 - each opening can support 5-8.8 mm PV cable outer diameter
 - each terminal block in the connection unit can support 4-10mm² PV wire cross section

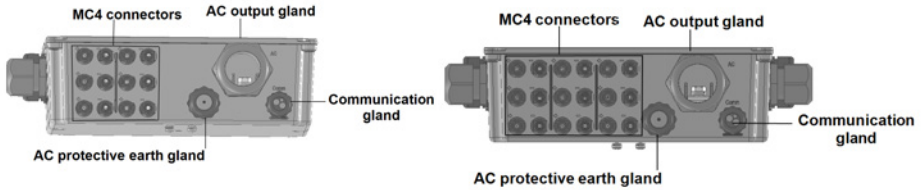

Figure 10: Connection Unit with MC4 Connectors bottom interface for 1 Secondary Unit (left), for 2 Secondary Units (right)

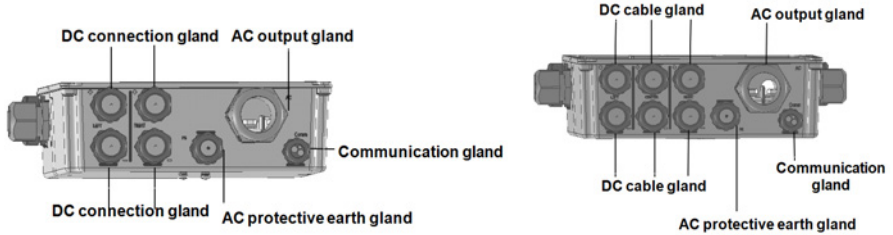

Figure 11: Connection Unit with glands bottom interface for 1 Secondary Unit (left), for 2 Secondary Units (right)

- **AC output:** cable gland for connection to the grid, M50 20-38mm diameter
- **AC protective earth gland:** cable gland for grounding, 9-16 mm diameter
- **Communication gland:** for connection of communication options. Refer to *Setting Up Communication* on page 54.

Secondary Unit Interface

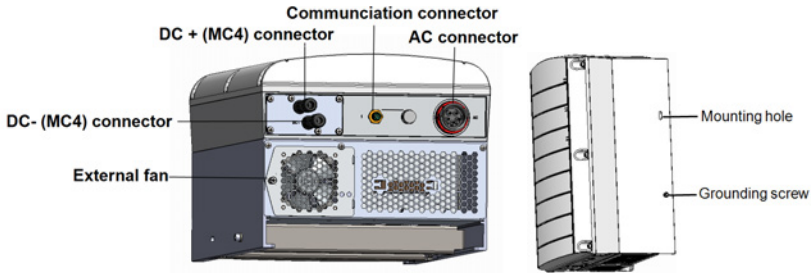

Figure 12: Secondary Unit bottom and side interfaces

- The Secondary units connectors are for connection to the Primary Unit:
 - **DC (MC4) connectors:** for connection of the PV installation
 - **Communication connector:** for communication options
 - **AC connector:** for connection of the AC
- **Mounting hole:** for securing the unit to the bracket and for connecting an optional secondary grounding cable.
- **Grounding screw:** for connecting an optional secondary grounding cable.

Mounting and Connecting the Primary and Secondary Unit(s)

The inverter is typically mounted vertically, and the instructions in this section are applicable for vertical installation. Some SolarEdge inverters model can be installed horizontally (above 10° tilt) as well as vertically. For information and instructions for horizontal mounting refer to

http://www.solaredge.com/sites/default/files/application_note_horizontal_mounting_of_three_phase_inverters.pdf



First mount the Primary Unit then the Secondary Unit(s).

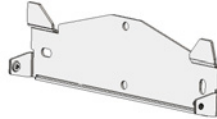

Figure 13: Mounting bracket



NOTE

Make sure the mounting surface or structure can support the weight of the inverter and brackets, and make sure that it spans the width of the mounting brackets.



CAUTION!

HEAVY OBJECT. To avoid muscle strain or back injury, use proper lifting techniques, and if required - a lifting aid.

1. Determine the inverter mounting location, on a wall or stud framing. It is recommended to mount the inverter in a location protected from direct sunlight.

- To allow proper heat dissipation, maintain the following minimum clearance areas between the inverter and other objects:



NOTE The Primary unit is longer than the Secondary Unit, therefore make sure the mounting location is high enough to fit the Primary Unit and leaves sufficient space for cable entry.

- If installing a single inverter:
 - At least 20 cm (8") from the top and bottom of each unit. For the Primary Unit, make sure to leave sufficient clearance for cable entry.
 - 3 cm (1.2") from the right and left of the unit.
- If installing multiple inverters:
 - When installing inverters one above of the other, leave at least 40 cm (16") between inverters. When installing the Primary Unit, leave 40 cm (16") between the top of the Primary Unit and the bottom of the Connection Unit.
 - When installing inverters side by side:

Location	Clearance	
	Indoor Installation	Outdoor Installation
Locations where the annual average high temperature ¹ is below 25°C / 77°F	20 cm / 8" between inverters	5 cm / 2" between inverters (if inverters are also installed one above the other, maintain the indoor installation clearance)
Locations where the annual average high temperature ¹ is above 25°C / 77°F	40 cm / 16" between inverters	

- Position the mounting brackets against the wall and mark the required drilling holes locations with the supplied level. The level markings correspond to a distance of 3 cm between units
- Drill two holes for each bracket and mount the brackets.
- Put in the screws without tightening in order to correct positioning.
- Place the level beneath the brackets and align the brackets, tighten the screws all the way and verify that the brackets are firmly attached to the mounting surface.

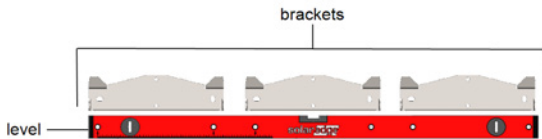

- Mount the Primary Unit:

¹Annual average high temperature – the average of the 12 monthly average highs, for example:

Average High Temperature												Years on Record: 20
ANNUAL	JAN	FEB	MAR	APR	MAY	JUN	JUL	AUG	SEP	OCT	NOV	DEC
C 21.5	11.8	12.6	15.4	21.5	25.3	27.6	29	29.4	28.2	24.7	18.8	14

Refer to <http://www.weatherbase.com/> to find the value in your location.

- Lift the Primary Unit from its sides.
- Align the two indentations in the enclosure with the two triangular mounting tabs of the bracket, and lower the unit until it rests on the bracket evenly (see *Figure 14*).
- Insert the supplied screw through the right side of the heat sink and into the bracket

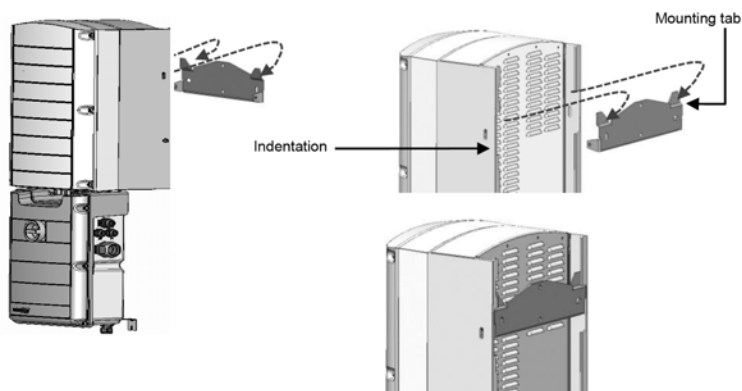

Figure 14: Hanging units

NOTE

If connecting secondary grounding, connect the grounding cable on either side of the chassis, to the upper mounting screw or to the lower grounding screw, before hanging the unit on the bracket, see *Connecting the AC Grid to the Connection Unit and Connecting Grounding* on page 1.

8. Mount the Secondary Unit(s):
 - There is no specific order for hanging the Secondary Units.
When installing a 2 unit inverter, mount the Secondary Unit to the left of the Primary Unit.
 - Lift the Secondary Unit(s) from the sides, or hold it at the top and bottom of the unit to lift into place.
 - Align the two indentations in the enclosure with the two triangular mounting tabs of the bracket, and lower the unit until it rests on the bracket evenly (see *Figure 14*).
 - Insert one of the supplied screws through the outer side of the heat sink and into the bracket. Tighten the screws with a torque of $4.0N*m / 2.9 lb. *ft.$
9. Secure the Connection Unit to the wall:
 - Mark the location of the bracket screw and drill the hole
 - Fasten the bracket using a standard bolt
 - Verify that the bracket is firmly attached to the mounting surface

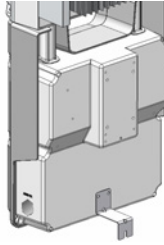

Figure 15: Connection Unit bracket

10. Connect the Connection Unit cables to the Secondary Unit(s) connectors.
 - Communication cable to communication connector
 - DC cables to DC+ and DC- connectors
 - AC cable to AC connector
 - Ensure the white mark on the AC connector, is lined between the arrows on the AC cable.
 - Plug the AC cable into the Secondary Unit.
 - Rotate the cable connector clockwise to fasten it.

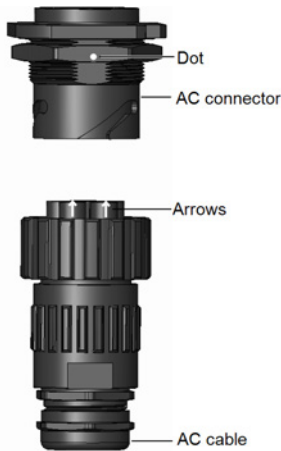

Figure 16: Connecting the AC connector to a Secondary Unit



NOTE

When connecting the AC cable to the left secondary Unit, loop the cable (see the following figure) to prevent pressure on the gland.



Figure 17: Connecting the Connection Unit to the Secondary Unit

11. Assemble the two parts of the cable lock (supplied with the inverter) around the cable connector, making sure that the orientation of the printed text on the lock is correct. Push the parts together until they click to lock. To open the lock use a flat-bladed screwdriver.

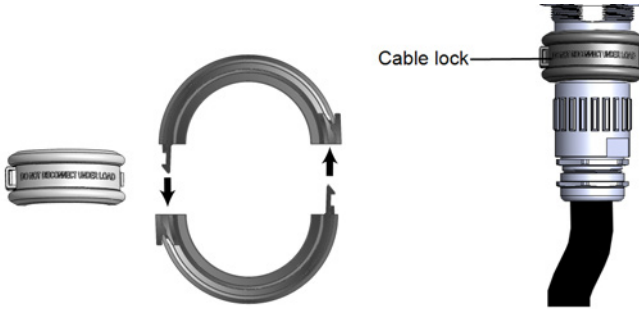

Figure 18: Cable lock

Chapter 4: Connecting the AC and Strings to the Connection Unit

This section describes how to connect the inverter to the AC grid, and to the PV strings .

Inverters of different models might be equipped with different sizes/ types of terminal blocks.

Grid Connection Guidelines

NOTE

In most countries, SolarEdge three phase inverters require neutral connection at all times (only grids with neutral connection are supported).

In some countries, the SolarEdge three phase inverters can be connected to 220 /230L-L delta grids. For more information prior to system installation refer to the Three Phase Inverters for Delta Grids application note,

https://www.solaredge.com/sites/default/files/se_three_phase_inverters_for_delta_grids.pdf.



and to Supported Countries application note to confirm compatibility:

http://www.solaredge.com/sites/default/files/se_inverters_supported_countries.pdf; installing without confirmation may void the inverter warranty.



For more wiring information refer to the *SolarEdge Recommended AC Wiring Application Note*, available on the SolarEdge website at <http://www.solaredge.com/files/pdfs/application-note-recommended-wiring.pdf>.

Connecting the AC Grid to the Connection Unit

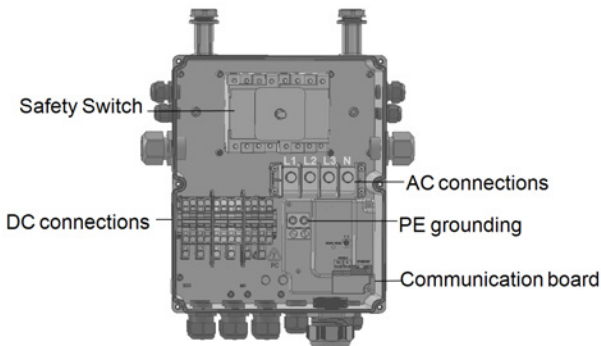

Figure 19: Inside the Connection Unit

**NOTE**

Functional electrical earthing of DC-side negative or positive poles is prohibited because the inverter has no transformer. Grounding (earth ground) of module frames and mounting equipment of the PV array modules is acceptable.

**NOTE**

SolarEdge's fixed input voltage architecture enables the parallel strings to be of different lengths. Therefore, they do not need to have the same number of power optimizers, as long as the length of each string is within the permitted range.

**WARNING!**

Turn OFF the AC before connecting the AC terminals. If connecting equipment grounding wire, connect it before connecting the AC Line and Neutral wires.

**NOTE**

It is recommended to connect communication connections (*Setting Up Communication* on page 54) before connecting the AC, for easier access to the communication board.

Connecting the AC Grid and Grounding to the Connection Unit

This section describes how to connect the AC grid and grounding to the Connection Unit .

Grounding

For grounding the Primary unit you can:

- thread a 4 wire AC cable through the AC gland and use an additional wire/cable for PE.
-or-
- thread a 5 wire AC cable with a PE (grounding) wire through the AC gland, see the following procedure. The AC gland supports a cable of 20-38 mm diameter, for larger cables use the previous option.

► To connect AC and ground:

1. Turn OFF the AC circuit breaker.
2. Open the Connection Unit cover: Release the six Allen screws and carefully move the cover horizontally before lowering it.

**CAUTION!**

When removing the cover, make sure not to damage internal components. SolarEdge will not be held responsible for any components damaged as a result of incautious cover removal.

3. Remove the terminal block cover.

- Strip the required length of the external and internal cables insulation.

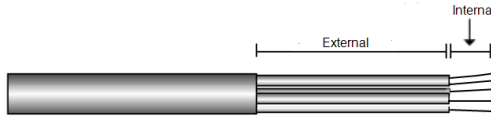

Figure 20: Insulation stripping – AC

- Open the AC cable gland and insert the cable through the AC gland.



WARNING! Turn OFF the AC before connecting the AC terminals. If connecting equipment grounding wire, connect it before connecting the AC Line and Neutral wires.

- If using a separate wire / cable for grounding , insert the additional wire/ cable for grounding through the PE gland.
 - Strip the required length of the external and internal cables insulation.
 - Open the PE cable gland and insert the cable through the PE gland.
- Connect the grounding wire to the grounding terminal block and tighten with a torque of 15N*m / 12 lb*ft.
- Remove the screws from the AC terminal blocks.
- Crimp ring terminals on the AC wires.



- Connect the wires to the terminal blocks with a proper tool according to the labels on the terminals.
- Tighten the screws of each terminal with a torque of 15N*m/12 lb*ft.

Wire type	Connect to terminal
Line 1	L1
Line 2	L2
Line 3	L3
Neutral	N

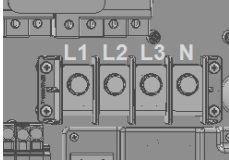

Figure 21: Wire connections to terminal block

- Place the cover on the terminal block and push until you hear a click.

Secondary Grounding

If required, ground the units as described in the following figure using a grounding cable, a grounding screw, two washers, a ring terminal and a serrated washer. You can connect the grounding cable to either side of a unit and to either the mounting hole or grounding screw. You can connect grounding to the Primary Unit and to each of the Secondary Units, as required.

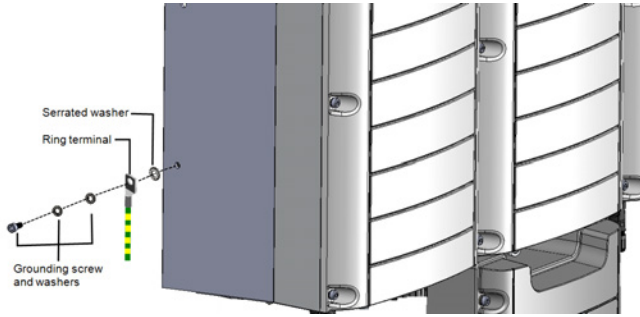

Figure 22: Secondary grounding

Connecting the Strings to the Connection Unit

You can connect systems with multiple DC strings in parallel to the DC input terminals of the Connection Unit.

NOTE



The DC bus of each unit is separate and not shared for all units. Therefore in addition to following the inverter design rules, each unit should follow the unit design rules as detailed in Technical Specifications.

Inverters may have a different number of pairs of DC input terminals, depending on the inverter power rating. If more strings are required, they can be connected in parallel using an external combiner box before connecting to the Connection Unit; strings connected to different units cannot be combined. When connecting multiple strings, it is recommended to run separate circuits to the Connection Unit or to position the combiner box near the Connection Unit. This simplifies commissioning by allowing testing and servicing near the inverter.

▶ To connect the strings to the Connection Unit with glands:

1. Strip 5/16" (8 mm) of the DC wire insulation.
2. Insert the DC cable from the PV installation, into the DC gland on the Connection Unit.
3. Connect the DC wires to the DC+ and DC- terminal blocks, according to the labels on the terminals. or; connect two wires (DC+ and DC-) per string:
 - a. Use a standard flat-blade screwdriver to connect the wires to the spring-clamp terminals. The screwdriver blade should fit freely in the terminal opening. Too large a blade can crack the plastic housing.
 - b. Insert the screwdriver and firmly tilt it to press the release mechanism and open the clamp.
 - c. Insert the wire into the top opening (see *Figure 23*).
 - d. Remove the screwdriver – the wire is automatically clamped.

CAUTION!



Ensure that the Plus (+) wire is connected to the + terminal and that the Minus (-) wire is connected to the Minus (-) terminal connector.

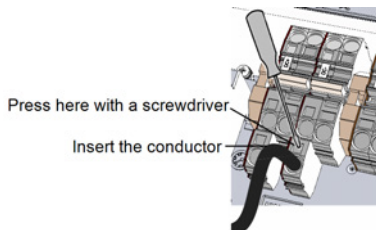

Figure 23: DC Spring-clamp terminals

5. Close the Connection Unit cover: Attach the switch cover and secure it by tightening the six screws with a torque of $1.2\text{N}\cdot\text{m}$ $0.9\text{ft}\cdot\text{lb}$.

► **To connect the strings to the Connection Unit with MC4 connectors:**

Connect the DC connectors of each string to the DC+ and DC- connectors according to the labels on the Connection Unit.

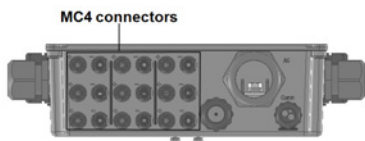

Figure 24: Connection Unit with MC4 Connectors

Selecting a Residual Current Device (RCD)

IMPORTANT SAFETY FEATURE



All SolarEdge inverters incorporate a certified internal Residual Current Device (RCD) in order to protect against possible electrocution and fire hazard in case of a malfunction in the PV array, cables or inverter. There are 2 trip thresholds for the RCD as required for certification (DIN VDE 0126-1-1). The default value for electrocution protection is 30 mA per unit, and for slow rising current is 300 mA per unit.

If an external RCD is required by local regulations, check which type of RCD is required for the relevant electric code. Install the residual-current device (RCD) in accordance with the applicable local standards and directives. SolarEdge recommends using a type A RCD. When required by local regulations, the use of an RCD type B is permitted.

Use at least 600mA RCD for a 2 unit inverter and at least 900mA RCD for a 3 unit inverter.



NOTE

For multiple inverters, an RCD per inverter is required.

You have completed installing the system, proceed to the next chapter to activate and commission it, then to *Setting Up Communication* on page 54, to set up required communication options and to set up master slave configurations, if required.

Chapter 5: Activating, Commissioning and Configuring the System Using SolarEdge Inverter SetApp

If applicable, you can connect communication options at this stage, as described in *Setting Up Communication* on page 54.

Once all connections are made, the system should be activated and commissioned using the SolarEdge Inverter SetApp mobile application. You can download the app from the iTunes and Google Play app stores prior to reaching the site.



Internet connection is required for the download and for the one-time registration, however not required for using the SetApp.

Step 1: Activating the Installation

During system activation, a Wi-Fi connection is created between the mobile device and the inverter and the system firmware is upgraded.

Before activation - download, register (first time only) and log-in to SetApp on your mobile device. Internet connection is required for the download and for the one-time registration.

► To activate the installation:

1. Turn ON the AC circuit breaker on the main distribution panel.
2. Move the inverter ON/ OFF/ P switch to the ON position.
3. Move the Connection Unit DC switch to the ON position.
4. Open SetApp and follow the instructions on the screen (scan the inverter bar-code; move the ON/OFF/P switch to P position and release within 5 sec. back to ON (1) position). SetApp creates a Wi-Fi connection, upgrades the inverter CPU firmware and activates the inverter.
5. When the activation is complete, do one of the following:
 - Select **Activate Another Inverter** to continue activating additional inverters
 - Select **Start Commissioning** for pairing and other system configuration. The Commissioning screen is displayed. Refer to the next section for more information.

Step 2: Commissioning and Configuring the Installation

This section describes how to use the SetApp menus for commissioning and configuring the inverter settings.

Menus may vary in your application depending on your system type.

► **To access the Commissioning screen:**

Do one of the following:

- During first time installation: Upon Activation completion, in the SetApp, tap **Start Commissioning**. The main Commissioning menu screen is displayed:

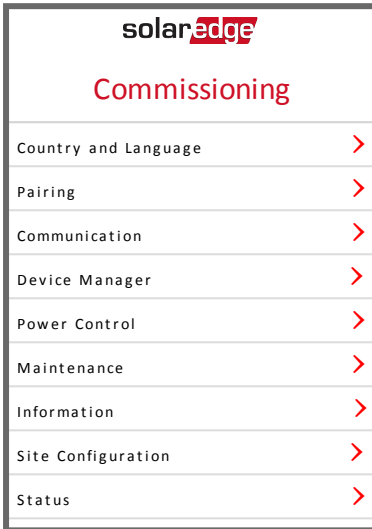

- If the inverter has already been activated and commissioned:
 - a. If not already ON - turn ON AC to the inverter by turning ON the circuit breaker on the main distribution panel.
 - b. If not already ON - move the Connection Unit switch to the ON position.
 - c. Open SetApp and follow the instructions on the screen (scan the inverter bar-code; move the ON/OFF/P switch to P position (for less than 5 sec) and release).

The mobile device creates a Wi-Fi connection with the inverter and displays the inverter main Status screen.

solar edge		
Status		
Inverter		
SN 07318000C		
Power 100 kW	Voltage 277 Vac	Frequency 60.9 Hz
P_OK: 138 of 141 Optimizers Connected	S_OK Server Connected	
Status Production	Switch ON	
CosPhi 1.00	Limit No Limit	Country Netherlands
Voltage 850 Vdc	Temp 156 F	Fan OK
Commissioning		

- d. Tap **Commissioning** at the bottom of the screen. The main Commissioning menu screen is displayed.

In the main menus, tap the menu red arrows (>) to perform the system commissioning or configuration task. Tap the **Back** arrow (<) to return to the previous menu.

The next sections provide more information about configuration options (in addition to **Country and Language** and **Pairing**, described in *Step 2: Commissioning and Configuring the Installation* on page 36).

Setting Country and Language

1. From the Commissioning screen select **Country and Language**.

2. From the **Country** drop-down list, select the required country setting.



WARNING!

The inverter must be configured to the proper setting in order to ensure that it complies with the country grid code and functions properly with the country grids.

1. From the **Language** drop-down list, select the language.
2. Tap **OK**.

Pairing

Once all connections are made, all the power optimizers must be logically paired to their inverter. The power optimizers do not start producing power until they are paired. This step describes how to assign each inverter to the power optimizers from which it will produce power.

Perform this step when the modules are exposed to sunlight. If the string length is changed or a power optimizer is replaced, repeat the pairing process.

1. From the main menu, select **Pairing**.

2. Tap **Start Pairing**.

3. When **Pairing Complete** is displayed, the system startup process begins:

Since the inverter is ON, the power optimizers start producing power and the inverter starts converting AC.

**WARNING!**

When you turn ON the inverter ON/OFF/P switch, the DC cables carry a high voltage and the power optimizers no longer output a safe 1V output.

When the inverter starts converting power after the initial connection to the AC, the inverter enters Wakeup mode until its working voltage is reached. This mode is indicated by the flickering green inverter LED.

When working voltage is reached, the inverter enters Production mode and produces power. The steadily lit green inverter LED indicates this mode.

4. Tap **OK** to return to the main menu.

Communication

Communication settings can be configured only after communication connections are complete. Refer to *Setting Up Communication* on page 54.

1. Select the **Communication** menu to define and configure the following:
 - The communication option used by the inverter to communicate with the SolarEdge monitoring platform
 - The communication option used to communicate between multiple SolarEdge devices or other external non-SolarEdge devices, such as electricity meters or loggers.

solar edge		
Communication		
Server	LAN	>
LAN	DHCP	>
RS485-1	SolarEdge Slave	>
RS485-2	Multi -Device (Modbus)	>
ZigBee	Home Automation Master	>
Wi-Fi	SEDG-7E129A09-33	>
RS232	SolarEdge GSM	
Cellular	N/A	>
GPIO	RRCR	>
Modbus TCP port	Disable	>

2. Tap the **Server** red arrow to set the communication method to be used for communication between devices and the SolarEdge monitoring platform. The default is LAN. Refer to *Setting Up Communication* on page 54 for a full description of these communication options.



NOTE

The Server menu shows only the communication options installed in the inverter.

Server		
LAN	S_OK	✓
Cellular		
Wi-Fi		
RS485-1 SolarEdge Slave		
ZigBee Slave		

For detailed information about all the configuration options, refer to the *Communication Options Application Note*, available on the SolarEdge website at https://www.solaredge.com/sites/default/files/solaredge-communication_options_application_note_v2_250_and_above.pdf.



Power Control

solar edge		
Power Control		
Grid Control	Enabled	>
Energy Manager		>
Power Reduction Interface (RRCR)	Enabled	>
Reactive Power	CosPhi	>
Active Power		>
Wakeup Configuration		>



Power control options are detailed in the *Power Control Application Note*, available on the SolarEdge website at http://www.solaredge.com/files/pdfs/application_note_power_control_configuration.pdf.



The Grid Control option may be disabled. Enabling it opens additional options in the menu.

The Energy Manager option is used for setting power export limitation, as described in the *Export Limitation Application Note*, available on the SolarEdge website at http://www.solaredge.com/files/pdfs/products/feed-in_limitation_application_note.pdf.



Maintenance

From the main menu, select **Maintenance** to configure various system settings, as described below.

solar edge		
Maintenance		
Date and Time	Sep-7 2017 09:45am	>
Temperature	Celsius	>
Reset Counters		>
Factory Reset		>
Arc Fault Circuit Interrupter (AFCI)	Enabled Automatic Reconnect	>
Firmware Upgrade		>
Load / Save Configuration		>
Diagnostics		>
Standby Mode	Disable	>
Grid Protection		>
Board Replacement		>

- **Date and Time:** Set the internal real-time clock. If connected to the SolarEdge monitoring platform, the date and time are set automatically and only time zone should be set.
- **Temperature:** Set the temperature units to use: Celsius or Fahrenheit
- **Reset Counters:** Resets the accumulated energy counters that are sent to the SolarEdge monitoring platform
- **Factory Reset:** Performs a general reset to the default device settings.
- **Arc Fault Circuit Interrupter (AFCI):** Enables or disables production interruption in case of arc-fault, sets the reconnection mode, and enables or disables manual AFCI self-test.
Refer to https://www.solaredge.com/sites/default/files/arc_fault_detection_application_note.pdf.
- **Firmware Upgrade:** Perform a software upgrade.
- **Load / Save Configuration:** Enables saving or loading system parameters from one inverter to another.



- **Diagnostics:** Displays the Isolation Status and Optimizers Status screens. Refer to www.solaredge.com/files/pdfs/application_note_isolation_fault_troubleshooting.pdf.
- **Standby Mode:** Enables/disables Standby Mode - for remote commissioning.
- **Grid Protection:** Available in specific countries. Enables viewing and setting grid protection values.
- **Board Replacement:** Backs up and restores the system parameters, including energy counters; Used during board replacement according to the instructions supplied with replacement kits.



Information

From the main menu, select **Information** to view and set various system settings, as described below.

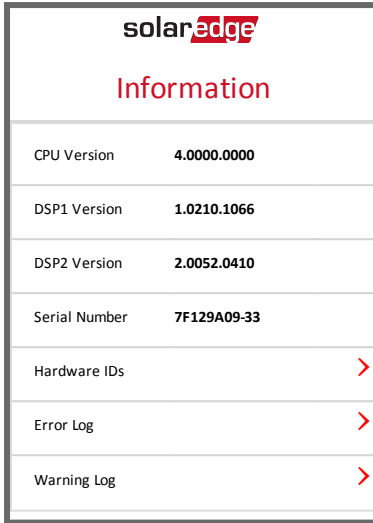

solar edge	
Information	
CPU Version	4.0000.0000
DSP1 Version	1.0210.1066
DSP2 Version	2.0052.0410
Serial Number	7F129A09-33
Hardware IDs	>
Error Log	>
Warning Log	>

- **CPU Version:** The communication board firmware version
- **DSP 1/2 Version:** The digital board firmware version



NOTE

Please have these numbers ready when you contact SolarEdge Support.

- **Serial Number** - The inverter serial number as appears on the enclosure sticker
- **Hardware IDs:** Displays the following HW serial numbers (if exist, and connected to the inverter):
 - **This inverter:** the inverter's ID
 - **Meter # :** Modbus meter ID (up to 3 meters can be connected)
 - **ZB:** ZigBee Card MAC address
 - **WiFi:** Wi-Fi MAC address
- **Error Log:** Displays the last five errors, and enables resetting (clearing) the log.
- **Warning Log:** Displays the last five warnings, and enables resetting (clearing) the log.

Step 3: Verifying Proper Activation and Commissioning

1. Select **Information** and verify that the correct firmware versions are installed on each inverter.
2. Select **Status** and verify that inverter is operating and producing power (see also *Viewing System Status* on page 48).
3. Verify that the number of paired optimizers is the same as the number of physically installed power optimizers.
4. Verify that additional configurations were properly set by viewing the relevant Status screens.
5. Verify that the green inverter LED is steadily lit.

Your SolarEdge power harvesting system is now operational.

Reporting and Monitoring Installation Data



NOTE

This step requires connecting one of the communication options. Refer to *Setting Up Communication* on page 54.

The SolarEdge Monitoring System

The SolarEdge cloud-based monitoring platform enables accessing SolarEdge site information, including up-to-date information viewed in a physical or logical view. The monitoring platform is described in detail in the *SolarEdge Monitoring Platform User Guide*, available on the SolarEdge website at

<http://www.solaredge.com/files/pdfs/solaredge-monitoring-platform-user-guide.pdf>.

The SolarEdge monitoring platform can display logical and physical layouts of the installed system, as follows:

- **Logical Layout:** Shows a schematic logical layout of the components in the system, such as: inverters, strings and modules, as well as their electrical connectivity. This view enables you to see which modules are connected in each string, which strings are connected to each inverter, and so on.
- **Physical Layout:** Shows a schematic physical layout of the components in the system, such as: inverters, strings and modules, as well as their electrical connectivity. This view enables a bird's eye view of the actual location of a system component.

Using the platform, you can:

- View the latest performance of specific components.
- Find under-performing components, such as modules, by comparing their performance to that of other components of the same type.
- Pinpoint the location of alerted components using the physical layout.
- See how components are connected to each other.
- Pair power optimizers remotely.

To display a logical layout, insert the inverter serial number in the new site created in the application. When the communication between the inverter and the monitoring server is established, the logical layout is displayed.

To display a physical layout, you need to map the locations of the installed power optimizers. To generate a physical mapping, use either the Site Mapper application or the physical layout editor in the monitoring platform.



The logical and physical mapping can be used for debugging a problem using the SolarEdge monitoring platform.

If you do not report the physical and logical mapping of the installed power optimizers to SolarEdge, the SolarEdge monitoring platform will show the logical layout indicating which power optimizers are connected to which inverter, but will not show strings or the physical location of power optimizers.

The inverter may be connected to the SolarEdge monitoring platform via LAN or by using a SolarEdge ZigBee Home Gateway system or a SolarEdge Cellular Modem. Alternatively, you can use RS485 chain (bus) connection to connect multiple SolarEdge devices to one inverter that is already connected to the server, in a master/slave configuration. Refer to *Setting Up Communication* on page 54 .

Providing Installation Information

Use one of the following methods to connect your PV system to the SolarEdge cloud-based monitoring platform (monitoring platform).

Site Mapper Application

Android

Use the SolarEdge Site Mapper smart-phone application to scan the power optimizer and inverter 2D bar-codes, and map the system physical layout in the SolarEdge monitoring platform. This application is integrated with the SolarEdge monitoring platform and enables:

- Simple on-site registration of new systems.
- Creating, editing and verifying system physical layout.
- Scanning and assigning the power optimizer serial number to the correct location in the system physical layout.

For detailed information, refer to the *SolarEdge Site Mapper* demo movies:

- [Creating new sites using the SolarEdge Site Mapper mobile application](#)
- [Mapping power optimizers using the SolarEdge Site Mapper mobile application](#)



iPhone

Use the SolarEdge Site Mapper smartphone application to scan the power optimizer and inverter 2D bar-codes. This application creates an XML file that can be uploaded to the SolarEdge monitoring platform during site registration. The SolarEdge Site Mapper can be downloaded from the application stores.

For detailed information, refer to the *SolarEdge Site Mapper Software Guide* or to the *Site Mapper* demo movie, available on the SolarEdge website at <http://www.solaredge.com/groups/installer-tools/site-mapper>.



Creating a Site in the SolarEdge Monitoring Platform

Create the site in the monitoring platform using the registration form available at <https://monitoring.solaredge.com/solaredge-web/p/login>. Fill out all required information in the form, which includes information about your installation, as well as details about its logical and physical mapping.



Paper Template

Fill out the Physical Layout Template (downloadable from the SolarEdge site) using the detachable 2D barcode stickers on each power optimizer. Once the form is completed, scan it and upload the scanned file to the SolarEdge monitoring platform during site registration. For an example paper template, refer to <http://www.solaredge.com/files/pdfs/physical-layout-template.pdf>.



Viewing System Status

During normal operation, the **Status** screen displays all the inverter settings and operation status. Scrolling down displays the values one after the other, as described in the following sections.

The LED indication provides more information about system performance; Refer to *LEDs* on page 19.

► To access the Status screen:

Do one of the following:

- During first time Commissioning and configuration: From the **Commissioning** menu select **Status**. The main inverter Status screen is displayed (see below)
- If the inverter has already been activated and commissioned - open SetApp and follow the instructions on the screen (scan the inverter bar-code; move the ON/OFF/P switch to P position (for less than 5 sec) and release).
The mobile device creates a Wi-Fi connection with the inverter and displays the inverter main Status screen.

A red or orange icon (for example: ) may appear at the top left corner of a status cell, indicating an error. The color indicates error severity (red is top severity). The error description or information appears on the screen. Tap the error line for more information and troubleshooting instructions, and refer to *Errors and Troubleshooting* on page 67.

A gray clock icon () may appear at the top left corner of a status cell, indicating a temporary status, such as a connection process. When the process is complete, the icon disappears and a constant status message is displayed.

Main Inverter Status

solar edge		
Status		
Inverter		
SN 07318000C		
Power 100 kW	Voltage 277 Vac	Frequency 60.9 Hz
P_OK: 138 of 141 Optimizers Connected	S_OK Server Connected	
Status Production	Switch OFF	
CosPhi 1.00	Limit No Limit	Country Netherlands
Voltage 850 Vdc	Temp 20 C	Fan OK
Switch Off. Production disabled >		
Commissioning		

- **Inverter:** The inverter serial number
- **Power:** The AC output power
- **Voltage (Vac):** The AC output voltage
- **Frequency:** The AC output frequency
- **P_OK: xxx of yyy:** There is a connection to the power optimizers and at least one power optimizer is sending monitoring data. XXX is the number of power optimizers for which telemetries have been received in the last two hours. YYY is the number of paired power optimizers identified during the most recent pairing process. If XXX and YYY are not equal, there may be a problem in one or more power optimizers.
- **S_OK:** The connection to the SolarEdge monitoring platform is successful (appears only if the inverter is connected to the monitoring platform).
- **Status:** The inverter operation status: Off, Not Paired, Night Mode, Error, Pairing, or Production
- **Switch:** Indicates the position of the inverter ON/OFF/P switch: On, Off, or P position.
- **CosPhi:** Indicates the ratio between active and reactive power. A negative value indicates a lagging CosPhi.

For more information, refer to the *Power Control Application Note*, available on the SolarEdge website at http://www.solaredge.com/files/pdfs/application_note_power_control_configuration.pdf.

- **Limit:** The inverter maximum output power
- **Country:** The selected country and grid setting
- **Voltage (Vdc):** The DC input voltage
- **Temp** (°C or °F): The inverter heat sink temperature



- **Fan:** Provides information about the fan status: OK, or Not working. For more information, refer to *External Fan Maintenance and Replacement* on page 75.

Multiple Inverters Status

The Multiple Inverters status screen shows the status of all inverters connected to a master inverter in a chain (bus). The master inverter is displayed first, and the connected inverters (slaves) appear one after the other when scrolling.

For inverters with secondary units, the status of secondary units is displayed on the screen. If a secondary unit is not operating, its column is grayed-out.

solar edge		
Status		
Multi-inverters		
Production	Limit	Inverters
1.00 MW	1.00 MW	10/10
Inverter		
SN 07318000C		
Power	Voltage	Frequency
100 kW	277 Vac	60.9 Hz
P_OK: 141 of 141	S_OK	
Optimizers Connected	Server Connected	
Status	⚠	Switch
Production		OFF
CosPhi	Limit	Country
1.00	Export	ITA
Inverter Units		
Secondary 1	Primary	Secondary 2
N/C	SN 07318000C	SN 07318000E
Voltage	Voltage	Voltage
N/A	850 Vdc	850 Vdc
P_OK	P_OK	P_OK
N/A	47 Of 47	47 Of 47
Temperature	Temperature	Temperature
N/A	156 F	156 F
Fan	Fan	Fan
N/A	OK	OK
⚠ Switch Off. Production disabled >		
Commissioning		

- **Site status:**
 - **Production:** The AC output power

- **Limit:** Limitation setting (Export or Production)
- **Inverters:** Number of connected inverters in the cluster, including the master.
- **Inverter status:** Displays status parameters of the primary unit of the *master* inverter. Refer to *Main Inverter Status* on page 49 for detailed information.
- **Inverter Units:** Displays the status parameters of the *master's* primary unit and secondary units. Refer to the values described in the Main Inverter Status section above.

Communication Status

This screen displays the status of connection option(s): LAN, RS485, Wi-Fi, GSM or ZigBee card.

Communication		
LAN	RS485-1	RS485-2
Connected	SE Slave NC	Modbus 2 of 2
Cellular	Wi-Fi	ZigBee
N/A	NC	NC

For each communication option, one of the following statuses is displayed:

- **Connected:** The inverter established a successful connection and communication with the specified server port/device
- **NC:** Not Connected. Refer to *Troubleshooting Communication* on page 71
- **S_OK:** The connection to the SolarEdge monitoring platform is successful (should appear only if the inverter is connected to the server)
- **N/A:** Not Applicable
- **x of y:** Number of devices connected out of all devices
- Temporarily displayed (with a ⌚ clock sign):
 - **Initializing communication**
 - **Connecting** to a network
 - **Connecting** to SolarEdge servers
- **Error message** (with the ⚠ sign). Refer to *Troubleshooting Communication* on page 71.

Inverter Energy Status

Displays the total energy produced during the last day, month, year and since inverter installation.

Inverter Energy		
Today	This Month	This Year
45 kWh	1.14 MWh	13.68 MWh
Total: 41.03 MWh		

- **Today:** since midnight
- **This Month:** since 1st of the current month
- **This Year:** since January 1st
- **Total (Wh):** The inverter total energy. If an external meter is installed, the value displayed in this line depends on the meter type connected to the inverter and its location:
 - If a bidirectional meter is connected at the consumption point, this value is the consumed energy.
 - If the meter is installed at the production point, this value is the energy produced by the site.
 - If the meter is installed at the grid connection point, this value is the energy exported to the grid.

Meter Status

Meters
Export – RS485-2 Modbus ID #2 Status: OK Power: 7.60kW, Energy: 13.68MWh
Export – GPIO S0 meter 1000 pulses per kWh Power: 7.60kW, Energy: 13.68MWh

- **Type and function:** Displays the meter functionality (Production, Export, Import, Export+Import)
- **Status:** Displays OK if the meter is communicating with the inverter
- **<Error message>:** If there is a meter error, it is displayed in this line.
- **Power:** Depending on the meter type connected to the inverter, this line displays the exported or imported power

- **Energy:** The total energy read by the meter. The value displayed in this line depends on the meter type connected to the inverter and its location:
 - If a bidirectional meter is connected at the consumption point, this value is the consumed energy.
 - If the meter is installed at the production connection point, this value is the energy produced by the site.
 - If the meter is installed at the grid connection point, this value is the energy exported to the grid.

**NOTE**

This data is accumulated according to an internal real-time clock.

Chapter 6: Setting Up Communication

The inverter sends the following information to the monitoring platform:

- Power optimizer information received via the DC power lines (the PV output circuit)
- Inverter information
- Information of any other connected devices

This chapter describes setting up communication between:

- the inverter and the monitoring platform through the Internet (wired/ wireless), or through a cellular connection
- multiple inverters for a master/slave configuration

Communication setup is not required for power harvesting, however it is needed for using the SolarEdge monitoring platform.



NOTE

It is recommended to connect communication connections before connecting the AC, for easier access to the communication board.



CAUTION!

When connecting the communication cables, make sure that the ON/OFF/P switch on the Connection Unit is turned OFF, and the AC is turned OFF.

When configuring the communication parameters, make sure that the ON/OFF/P switch on the Connection Unit is OFF, and the AC is turned ON.

Communication Options

The following types of communication can be used to transfer the monitored information from the inverter to the SolarEdge monitoring platform.

Only communication products offered by SolarEdge are supported.

Ethernet

Ethernet is used for a LAN connection. For connection instructions refer to *Creating an Ethernet (LAN) Connection* on page 58.

RS485

RS485 is used for the connection of multiple SolarEdge devices on the same bus in a master-slave configuration. RS485 can also be used as an interface to external devices, such as meters and third party data loggers.

- RS485-1: Enables the connection of multiple inverters over the same bus, such that connecting only one inverter to the Internet is sufficient to provide communication services for all the inverters on the bus. RS485-1 has built-in surge protection.
- RS485-2: Enables connection of non-SolarEdge devices.

For connection instructions refer to *Creating an RS485 Bus Connection* on page 61

Wi-Fi

Wi-Fi is built into the inverter but an antenna is required, which is available from SolarEdge.

GSM

This wireless communication option (purchased separately) enables using a GSM connection to connect one or several devices (depending on the data plan used) to the SolarEdge monitoring platform.

The GSM cellular modem is provided with a user manual, which should be reviewed prior to connection. Refer to http://www.solaredge.com/sites/default/files/cellular_gsm_installation_guide.pdf



Communication Connectors

The Primary Unit has communication glands for connecting the various communication options to the inverter, as described in the following table. Unused openings should remain sealed.

	Gland#	Opening	Functionality
Primary Unit	1	two large openings 4.5-7 mm	Cellular
		one small opening 2-4 mm	external antenna cable
	2	three large openings 2.5-5 mm	power reduction and RS485-2
Connection Unit	1	three openings	Ethernet connection (CAT5/6)and RS485 -1

Communication gland 1



Figure 25: Primary Unit

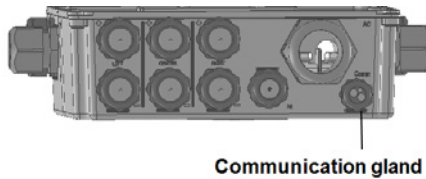

Figure 26: Connection Unit bottom

Communication Board

The communication board is in the Primary Unit with an extension in the Connection Unit.

Primary Unit Communication Board

Open the Primary Unit cover to access the communication board to:

- GSM- connect a GSM modem. See *Communication Options* on page 55.
- RS485-1 - connected to the Connection Unit communication board. For connecting multiple inverters over the same bus, connect RS485 wires to the terminal blocks on the Connection Unit Communication Board. For more information see, *Connection Unit Communication Board* on page 58
- RS485-2 - connect a non-SolarEdge device, such as a meter or a third party data logger, to the RS485-2 connector. Every pair of in and out wires are connected to the same pin.
- Power Reduction Interface (PRI) - connect a power reduction device. See [application_note_power_control_configuration.pdf](#)

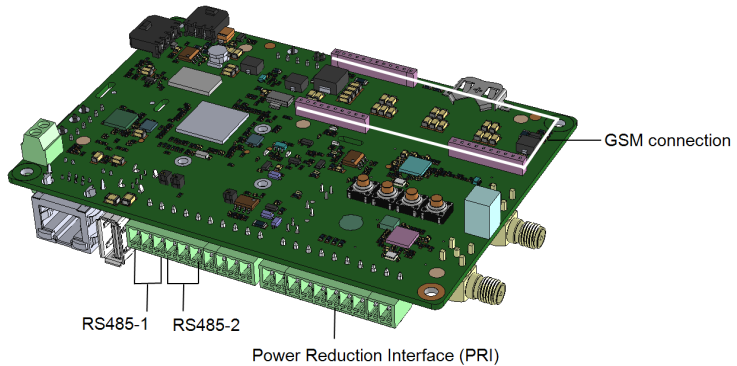

Figure 27: Primary Unit communication board

Connection Unit Communication Board

Open the Connection Unit cover to access the communication board to:

- connect a standard RJ45 connector for Ethernet.
- connect RS485 wires to the terminal blocks for RS485 connection. There are two 3-pin terminal blocks, one for connecting the preceding device in the bus and one for connecting the following device. Additionally, the RS485 port has a built-in surge protection.

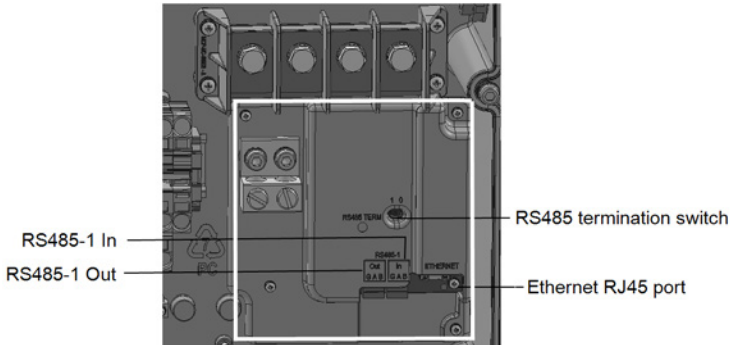

Figure 28: Connection Unit Communication board

Removing the Connection Unit Cover

If the Connection Unit is not already removed, remove it as described in the following section.

► To remove the Connection Unit cover:

1. Turn OFF the inverter ON/OFF switch, and wait until the green LED is blinking, indicating that the DC voltage is safe (<50V), or wait five minutes before continuing to the next step.
2. Disconnect the AC to the inverter by turning OFF the circuit breakers on the distribution panel.
3. Open the Connection Unit cover:
 - a. Release the six Allen screws of the cover.
 - b. Tilt the top of the cover towards you.
 - c. Slide the cover down and remove it.



CAUTION!

When removing the cover, make sure not to damage internal components. SolarEdge will not be held responsible for any components damaged as a result of incautious cover removal.

Creating an Ethernet (LAN) Connection

This communication option enables using an Ethernet connection to connect the inverter to the monitoring platform through a LAN.

Ethernet cable specifications:

- Cable type – a shielded Ethernet cable (Cat5/5E STP) may be used
- Maximum distance between the inverter and the router – 100 m/ 330 ft.

NOTE



If using a cable longer than 10 m / 33 ft in areas where there is a risk of induced voltage surges by lightning, it is recommended to use external surge protection devices.

For details refer to: http://www.solaredge.com/files/pdfs/lightning_surge_protection.pdf.

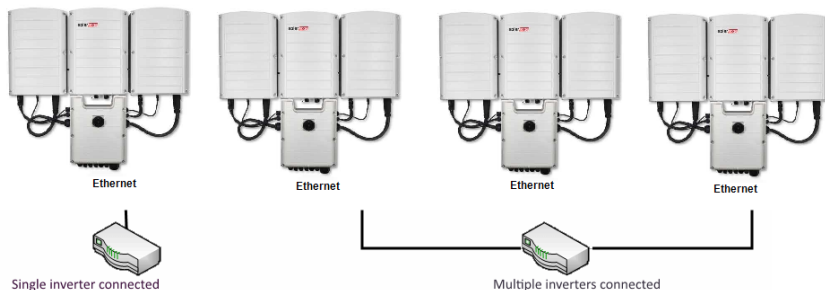

Figure 29: Example of Ethernet connection

To connect the Ethernet cable:

1. Open the communication gland.



CAUTION!

The gland includes a rubber waterproof fitting, which should be used to ensure proper sealing.

2. Remove the rubber fitting from the gland and insert the CAT5/6 cable through the gland and through the gland opening in the Connection Unit .
3. Remove the plastic seal from the large opening that has a cut in the rubber fitting.
4. Push the cable into the cut opening of the rubber fitting.

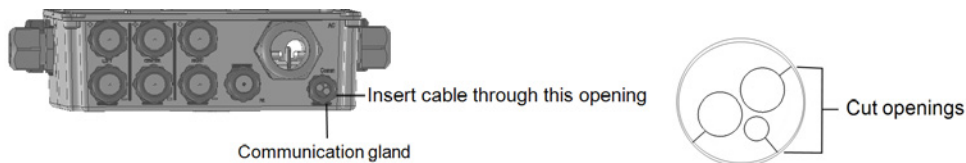

Figure 30: Communication gland and rubber fitting

CAT5/5E STP cables have eight wires (four twisted pairs), as shown in the diagram below. Wire colors may differ from one cable to another. You can use either wiring standard, as long as both sides of the cable have the same pin-out and color-coding.

RJ45 Pin #	Wire Color ¹		10Base-T Signal 100Base-TX Signal
	T568B	T568A	
1	White/Orange	White/Green	Transmit+
2	Orange	Green	Transmit-
3	White/Green	White/Orange	Receive+
4	Blue	Blue	Reserved
5	White/Blue	White/Blue	Reserved
6	Green	Orange	Received-
7	White/Brown	White/Brown	Reserved
8	Brown	Brown	Reserved

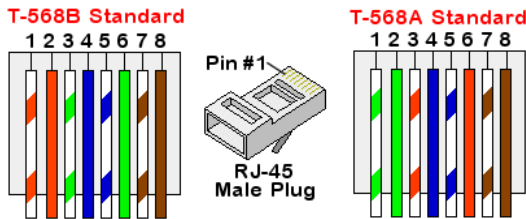

Figure 31: Standard cable wiring

5. Use a pre-terminated cable to connect via the gland to the RJ45 port on the inverter's communication board or, if using a spool of cable, connect as follows:
 - a. Insert the cable through the gland.
 - b. Remove the cable's external insulation using a crimping tool or cable cutter and expose eight wires.
 - c. Insert the eight wires into an RJ45 connector, as described *Figure 31*.
 - d. Use a crimping tool to crimp the connector.
 - e. Connect the Ethernet connector to the RJ45 port on the communication board as shown in *Figure 31*.

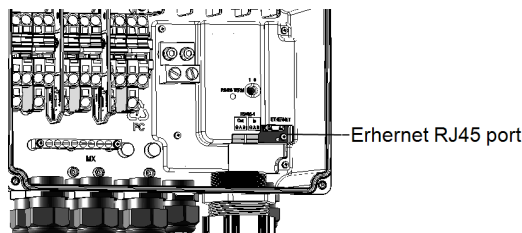

Figure 32: Connection Unit Communication board

6. For the switch/router side, use a pre-terminated cable or use a crimper to prepare an RJ45 communication connector.

¹The connection does not support RX/TX polarity change. Supporting crossover Ethernet cables depends on the switch capabilities.

7. Connect the cable RJ45 connector to the RJ45 port of the Ethernet switch or router. You can connect more than one inverter to the same switch/router or to different switches/routers, as needed. Each inverter sends its monitored data independently to the SolarEdge monitoring platform.

**NOTE**

There are no LED indicators on the Ethernet connector, if the inverter is not communicating with the monitoring platform through a LAN refer to *Troubleshooting Communication* on page 71.

8. The inverter is configured by default to LAN. If reconfiguration is required:
 - a. Verify the ON/OFF switch is OFF.
 - b. Verify the AC is on.
 - c. Close the cover and turn ON the Connection Unit.

**WARNING!**

ELECTRICAL SHOCK HAZARD. Do not touch uninsulated wires when the Connection Unit cover is removed.

- d. Use the SolarEdge SetApp to access the **Commissioning** main menu screen as described in *Communication* on page 40.
 - e. From the main menu tap **Communication**. The Communication screen is displayed:
 - f. Select the following to configure the connection:
 - Server → **LAN**
 - LAN → DHCP → **Enable**
9. Verify the connection, as described in *Verifying the Connection* on page 65.

**NOTE**

The system automatically establishes communication with the monitoring platform as it is configured to LAN by default.

**NOTE**

If your network has a firewall, you may need to configure it to enable the connection to the following address:

- Destination Address: prod.solaredge.com
- Modbus TCP Port: 22222 (for incoming and outgoing data)

Creating an RS485 Bus Connection

The RS485 option enables creating a bus of connected inverters, consisting of up to 31 slave inverters and 1 master inverter. Using this option, inverters are connected to each other in a bus (chain) via their RS485 connectors, thus allowing to connect only the master inverter to the monitoring platform. The first and last inverters in the chain must be terminated as described in *RS485 Bus Configuration* on page 64

RS485 wiring specifications:

- Cable type: Min. 3-wire shielded twisted pair (a shielded Ethernet cable (Cat5/5E STP) may be used)
- Wire cross-section : 0.2- 1 mm²/ 24-18 AWG
- Maximum distance between first and last devices: 1 km /3300 ft.

The following sections describe how to physically connect the RS485 bus and how to configure the bus.

To connect the RS485 communication bus:

1. Open the communication gland.



CAUTION!

The gland includes a rubber waterproof fitting, which should be used to ensure proper sealing.

2. Remove the rubber fitting from the gland and insert the CAT5/6 cable through the gland and through the gland opening in the Connection Unit.
3. Remove the seal from one of the openings in the communication gland and insert the wire through the opening.
4. Pull out both 3-pin RS485 terminal blocks, as shown below:

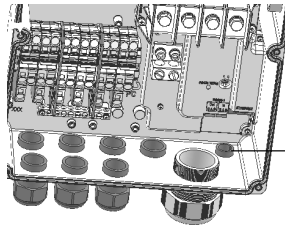

Insert cable through this opening

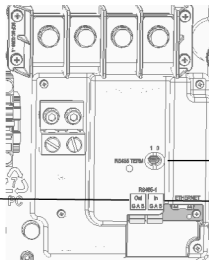

RS485-1 Out

RS485 Termination Switch

RS485-1 In

Figure 33: RS485 connectors and termination switch

- Loosen the screws of pins A(+), B(-), and G in either the 'Out' or 'In' RS485 terminal block.

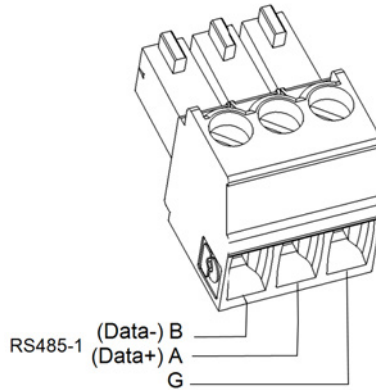

Figure 34: RS485 terminal block wire connections

- Insert the wire ends into the **G**, **A** and **B** pins shown above. Use one terminal block for the previous inverter in the bus and the other terminal block for the next inverter in the bus, as shown in *Figure 35*. You can use any color wire for each of the **A**, **B** and **G** connections, as long as the same color wire is used for all A pins, the same color for all B pins and the same color for all G pins.
- Connect all B, A and G pins in all inverters. The following figure shows this connection schema:

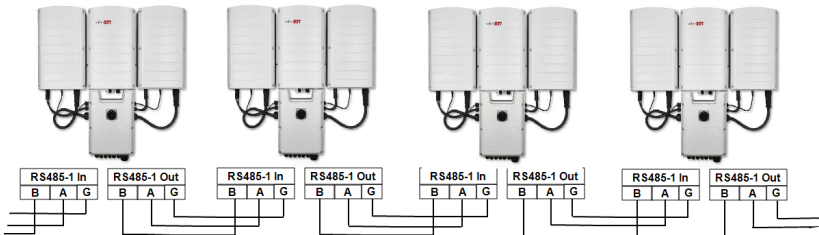
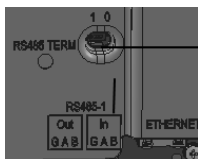

Figure 35: Connecting the inverters on a bus

- Tighten the terminal blocks screws.
- Check that the wires are fully inserted and cannot be pulled out easily.
- Push the RS485 terminal blocks firmly all the way into the connectors on the communication board, see *Figure 33*.
- Terminate the first and last inverters on the bus by moving the termination switch to ON (left position). The other inverters on the bus should have the termination switch OFF (right position).



RS485 termination switch

RS485 Bus Configuration

▶ To connect to the monitoring platform:

1. Designate a single inverter as the connection point between the RS485 bus and the SolarEdge monitoring platform. This inverter will serve as the master inverter.
2. Connect the master to the SolarEdge monitoring platform via the LAN option (refer to *Creating an Ethernet (LAN) Connection* on page 58) or any of the other options.

▶ To configure the RS485 bus:

All inverters are configured by default as slaves. To configure the master:

1. Verify the ON/OFF/P switch is OFF.
2. Verify the AC is on.
3. Turn ON the Connection Unit.
4. Use SetApp to access the **Commissioning** main menu screen as described in *Communication* on page 40.
5. From the main menu tap **Communication**. The Communication screen is displayed:

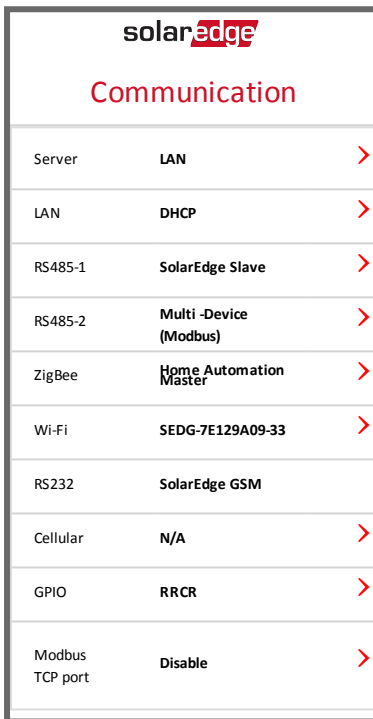

6. Select the following to configure the connection:

- Server → LAN
- RS485-1 → Protocol → SolarEdge Master
- RS485-1 → Slave Detect

The system starts automatic detection of the SolarEdge slave inverters connected to the master inverter. The inverter should report the correct number of slaves. If it does not, verify the connections and terminations.

RS485-1	
Protocol	SolarEdge (Master) >
Device ID	1
Slave Detect	3 Slaves >
Long Slave Detect	3 Slaves >
Slave List	3 Slaves >

7. To check the slave IDs and last communication time, select **RS485-1** → **Slave List**.

8. Verify the connection of the master to the SolarEdge monitoring platform, as described in the next section.

Verifying the Connection

After connecting and configuring a communication option, perform the following steps to check that the connection to the monitoring server has been successfully established.

1. If the Connection Unit cover is not closed, close it: Attach the Connection Unit cover and secure it by tightening the screws with a torque of 10.3 N*m/ 7.5 lb.*ft. For proper sealing, first tighten the corner screws and then the two central screws.
2. Access the Status screen:
 - a. If not already ON - turn ON AC to the inverter by turning ON the circuit breaker on the main distribution panel.
 - b. If not already ON - move the Connection Unit switch to the ON position.
 - c. Open SetApp and follow the instructions on the screen (scan the inverter bar-code; move the ON/OFF/P switch to P position (for less than 5 sec) and release).

The mobile device creates a Wi-Fi connection with the inverter and displays the inverter main Status screen.

3. Check that **S_OK - Server Connected** status appears in the main inverter section:

solar edge		
Status		
Inverter		
SN 07318000C		
Power 100 kW	Voltage 277 Vac	Frequency 60.9 Hz
P_OK: 138 of 141 Optimizers Connected	S_OK Server Connected	
Status Production	Switch ON	
CosPhi 1.00	Limit No Limit	Country Netherlands
Voltage 850 Vdc	Temp 156 F	Fan OK
Commissioning		

4. Scroll down to the **Communication** section and check that the communication options are as required. For more information refer to *Communication Status* on page 51.

Communication		
LAN Connected	RS485-1 SE Slave NC	RS485-2 Modbus 2 of 2
Cellular N/A	Wi-Fi NC	ZigBee NC

Appendix A: Errors and Troubleshooting

This appendix describes general system problems, and how to troubleshoot them. For further assistance, contact SolarEdge Support.

Identifying Errors

Errors may be indicated in various system interfaces: On the inverter bottom panel, a red LED indicates an error. In the monitoring platform and the SolarEdge SetApp, errors are displayed with codes.

For more information on the codes displayed for error and warning messages, refer to <http://www.solaredge.com/sites/default/files/se-inverter-installation-guide-error-codes.pdf>.



To identify the error types, use the methods described below.

▶ **To identify the error type using the inverter LEDs:**

1. Move the ON/OFF/P switch to **P** position for **less** than 5 seconds and release it.
2. Observe the LED lights and use the following table to identify the error type

Error type	LED color and state		
	Red	Green	Blue
Arc detected	ON	OFF	OFF
Isolation or RCD problem	Blinking	OFF	OFF
Grid error	OFF	ON	OFF
High temperature	OFF	Blinking	OFF
Pairing failed	OFF	OFF	ON
Other issue	OFF	OFF	Blinking

▶ **To identify the error type using the monitoring platform:**

1. Open the site dashboard and click the **Layout** icon.

- Right-click the inverter and select **Info** from the menu (Figure 36). The inverter details window is displayed (Figure 37).

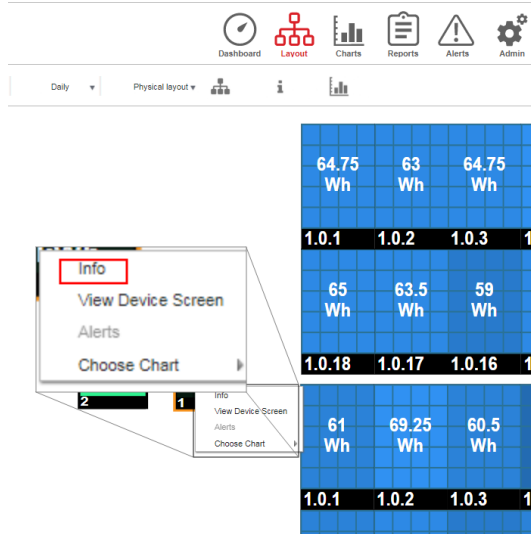

Figure 36: Inverter menu

- Click the **Errors** tab. The list is displayed.

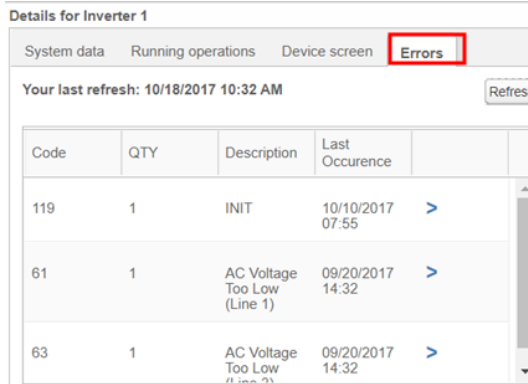

Figure 37: Inverter details - Error list

To identify the error type using SetApp:

- Access the Status screen as described in *Viewing System Status* on page 48.
- Check for errors indicated by a red or orange icon (for example:). The color indicates error severity (red is higher severity).

3. Tap the error line for more information and troubleshooting instructions.

solaredge

Status

❗ Error 3x303: Grid unstable

Inverter
SN 07318000C

Power	Voltage	Frequency
100 kW	277 Vac	60.9 Hz

P_OK: 138 of 141 Optimizers Connected	S_OK Server Connected
Status Production	Switch OFF

CosPhi	Limit	Country
1.00	No Limit	USA2
Voltage	Temp	Fan
850 Vdc	156 F	OK

❗ Error 18X37: V-Line Max. >

❗ Switch Off. Production disabled >

• **Commissioning**



**Error 18x37: V-Line Max
Troubleshooting**

AC voltage too high:

- Verify that the inverter is set to the correct country.
- Turn OFF the inverters in the site and verify AC grid voltage.
- If the inverter is located far from the connection point to the grid, use a larger gauge AC wire.
- Consult the grid operator.
- If permitted by local authorities, change the grid protection values.

Refer to:
http://www.solaredge.com/files/pdf/s/viewing_grid_protection_values.pdf

OK

Power Optimizer Troubleshooting

Problem	Possible cause and troubleshooting
Pairing failed	<p>Power optimizers are shaded.</p> <p>If you connected the inverter to the SolarEdge monitoring platform, retry pairing remotely (during sunlight). Make sure to leave the inverter ON/OFF switch ON and that S_OK appears in the status screen.</p>
String voltage is 0V	<p>Power optimizer(s) output is disconnected.</p> <p>Connect all power optimizer outputs.</p>
String voltage not 0V but lower than number of optimizers	<p>Power optimizer(s) not connected in the string.</p> <p>Connect all power optimizers</p>
	<p>Module(s) not connected properly to power optimizer inputs (not applicable to smart modules).</p>
	<p>Connect the modules to the optimizer inputs</p> <p>String reverse polarity.</p> <p>Check string polarity using a voltmeter and correct if needed.</p>
String voltage is higher than number of optimizers	<p>Extra power optimizer(s) connected in the string (not applicable to smart modules).</p> <p>Check if an extra power optimizer is connected in the string. If not – proceed to next solution.</p>
	<p>A module is connected directly to the string, without a power optimizer (not applicable to smart modules).</p> <p>Verify that only power optimizers are connected in the string and that no module outputs are connected without a power optimizer. If the problem persists, proceed to the next step.</p>
<p> WARNING!</p> <p>If the measured voltage is too high, the installation may not have a safe low voltage. PROCEED WITH CARE! A deviation of $\pm 1\%$ per string is reasonable.</p>	<p>Power optimizer(s) malfunction.</p> <ul style="list-style-type: none"> ○ Disconnect the wires connecting the power optimizers in the string. ○ Measure the output voltage of each power optimizer to locate the power optimizer that does not output 1V safety voltage. If a malfunctioning power optimizer is located, check its connections, polarity, module, and voltage. ○ Contact SolarEdge Support. Do not continue before finding the problem and replacing the malfunctioning power optimizer. If a malfunction cannot be bypassed or resolved, skip the malfunctioning power optimizer, thus connecting a shorter string.

Troubleshooting Communication

Troubleshooting Ethernet (LAN) Communication

The possible errors and their troubleshooting are detailed in the following table:

Error Message	Cause and Troubleshooting
LAN cable disconnected	Physical connection fault. Check the cable pin-out assignment and cable connection. Refer to <i>Creating an Ethernet (LAN) Connection</i> on page 58.
No DHCP	IP settings issue. Check the router and inverter configuration. Consult your network IT.
Configure Static IP or set to DHCP	
Gateway not responding	Ping to router failed. Check the physical connection to the switch/ router. Check that the link LED at the router /switch is lit (indicating phy-link). If OK - contact your network IT, otherwise replace the cable or change it from cross to straight connection.
No Internet connection	Ping to google.com failed. Connect a laptop and check for internet connection. If internet access is unavailable, contact your IT admin or your internet provider. For Wi-Fi networks, ensure that user-name and password are as defined in the internet provider AP/ router.
No connection to SolarEdge servers	Ping or connection to SolarEdge server failed. Check the SolarEdge server address, under LAN Conf sub-menu: Address: prod.solaredge.com Port: 22222 Check with your network administrator whether a firewall or another device is blocking transmission.

Troubleshooting RS485 Communication

- If the message **RS485 Master Not Found** appears in the Status screen, check the connections to the master device and fix if required.
- If after slave detection the number of slaves displayed for the master under **RS485-X Conf → Slave Detect** is lower than the actual number of slaves, use one of the following methods to identify missing slaves and troubleshoot connectivity problems:
 - Use the **Long slave Detect** to retry connecting to slaves
 - Analyze the slave list to check for missing slaves, and check their connection

Refer to https://www.solaredge.com/sites/default/files/troubleshooting_undetected_RS485_devices.pdf



Additional Troubleshooting

1. Check that the modem or hub/router is functioning properly.
2. Check that the connection to the internal connector on the communication board is properly done.

3. Check that the selected communication option is properly configured.
4. Use a method independent of the SolarEdge device to check whether the network and modem are operating properly. For example, connect a laptop to the Ethernet router and connect to the Internet.
5. Check whether a firewall or another type of network filter is blocking communication.

Appendix B: Mechanical Specifications

The following figures provide dimensions of the Primary Unit, Connection Unit and Secondary Unit.

Primary Unit and Connection Unit

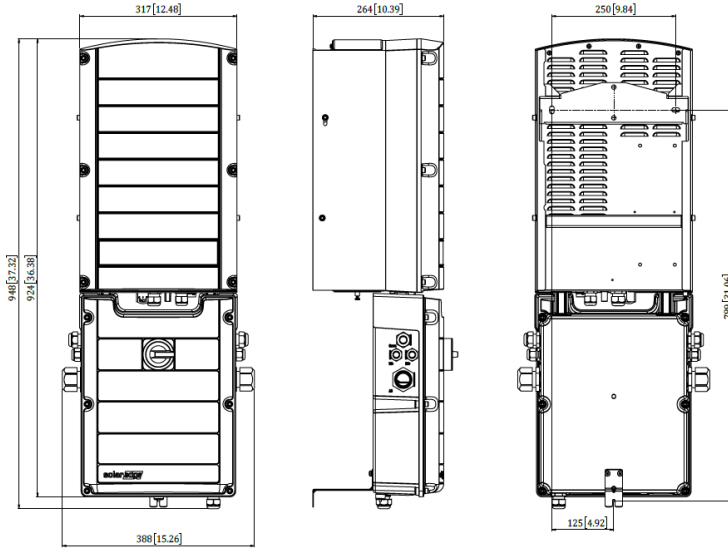

Figure 38: Primary Unit and Connection Unit - front, side and rear views

Secondary Unit

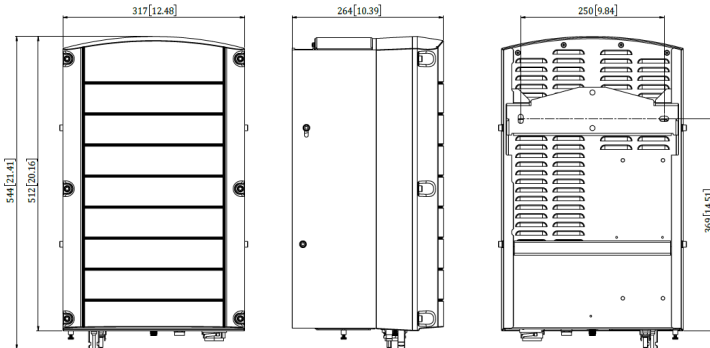

Figure 39: Secondary Unit - front, side and rear views

Appendix C: SafeDC™

When AC supply to the inverter is shut off (by shutting off the AC breaker at the site), or when the inverter ON/OFF/P switch is turned to OFF, the DC voltage drops to a safe voltage of 1V per optimizer.

The SolarEdge inverters are certified for compliance with the following standards as disconnection devices for PV generators, meaning that they can replace a DC disconnect:

- IEC 60947-3:1999 + Corrigendum: 1999 + A1:2001 + Corrigendum 1:2001 + A2:2005;
- DIN EN 60947-3
- VDE 0660-107:2006-03
- IEC 60364-7-712:2002-05
- DIN VDE 0100-712:2006-06.

In compliance with these standards, the disconnection mechanism operates as follows:

1. Turn the inverter ON/OFF/P switch, located at the bottom of the inverter, to OFF, or disconnect the AC by shutting off the AC breaker at the site. The DC voltage displayed on the inverter LCD begins to decrease.
If the AC breaker was shut off, the LCD does not display. In this case, wait five minutes.
2. When the DC voltage reaches a safe voltage, the PV connectors at the input to the inverter can be disconnected. A galvanic separation then exists between the PV array and the inverter.

WARNING!

SafeDC complies with IEC60947-3 when installing the system with a worst case SafeDC voltage (under fault conditions) < 120V.

The worst case voltage is defined as: $V_{oc,max} + (\text{String Length} - 1) * 1V$, where:

- $V_{oc,max}$ = Maximum Voc (at lowest temperature) of the PV module in the string (for a string with multiple module models, use the max value)
- String Length = number of power optimizers in the string



Appendix D: External Fan Maintenance and Replacement

The Primary and Secondary Units have two fans each: one is internal and the other is accessible from the outside of the unit. This appendix describes external fan replacement.

A fan replacement kit is available from SolarEdge.



Figure 40: Primary Unit (left) and Secondary Unit (right) external fans

Fan Maintenance

At least once a year, open the fan screen and clean the accumulated dust using a brush.

If you receive a **Not Working Fan Status** notification via the SetApp replace the fan as described in the following section.

External Fan Replacement

1. Turn OFF the inverter ON/OFF switch, and wait until the green LED is blinking, indicating that the DC voltage is safe (<50V), or wait five minutes before continuing to the next step.
2. Disconnect the AC to the inverter by turning OFF the circuit breakers on the distribution panel.
3. Use a standard screwdriver to unfasten the single screw of the fan cover and open the fan door.

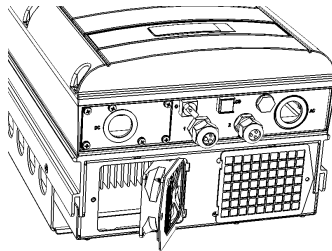

Figure 41: Fan door open

4. Disconnect the fan connector and remove the fan.

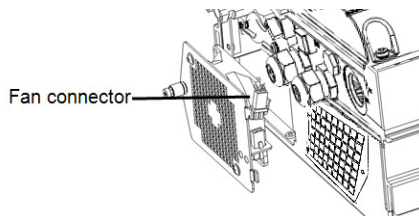

Figure 42: Fan connector

5. Connect the fan connector to the new fan.
6. Close the fan door and fasten the cover screw.
7. After powering up the inverter, check the fan status on SetApp.Go to, **Commissioning**→**Status**

The screenshot shows the solar edge SetApp interface. On the left is a 'Commissioning' menu with options: Country and Language, Pairing, Communication, Power Control, Maintenance, Information, Site Configuration, and Status. The 'Status' option is highlighted with a red box. On the right is the 'Status' page for Inverter SN 07318000C. It displays various operational parameters in a table format.

Status		
Inverter SN 07318000C		
Power 7.60 kW	Voltage 240 V _{ac}	Frequency 60.9 Hz
P_OK: 30 of 30 Optimizers Connected		S_OK Server Connected (LAN)
Status Production		Switch ON
Cos Phi 1.00	Limit No Limit	Country USA2
Voltage 380 V _{dc}	Temp. 156 F	Fan OK

Appendix E: Replacing System Components

This appendix details replacement procedures for the SolarEdge system components.



NOTE

If you are permanently disassembling the installation or part of it, make sure to use the disposal methods dictated by local regulations.

Replacing the Primary Unit

1. Turn OFF the Inverter ON/OFF switch, and wait until the green LED is blinking, indicating that the DC voltage is safe (<50V), or wait five minutes before continuing to the next step.



WARNING!

If you cannot see Primary Unit LEDs or you cannot connect to the Primary Unit, or if the red LED light is on indicating a malfunction, wait five minutes for the input capacitors of the inverter to discharge.

2. Disconnect the AC to the inverter by turning OFF the circuit breakers on the distribution panel.
3. For a 3-unit inverter first disconnect and remove the Secondary Unit on the right.
4. Open the Primary Unit cover:
 - a. Release the six Allen screws of the cover.
 - b. Tilt the top of the cover towards you.
 - c. Slide the cover down and remove it.



CAUTION!

When removing the cover, make sure not to damage internal components. SolarEdge will not be held responsible for any components damaged as a result of incautious cover removal.

5. Disconnect all DC, AC wires and the communication connectors from the Primary Unit.

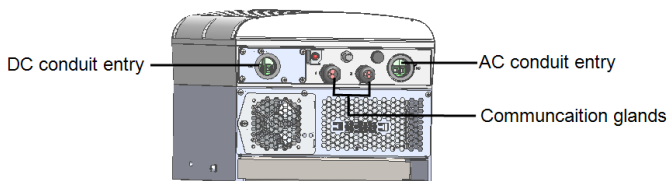

Figure 43: Primary Unit interface

6. Unscrew the two conduit nuts in the Primary Unit securing it to the Connection Unit.

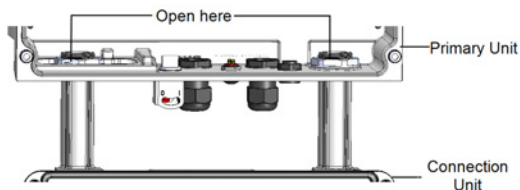

Figure 44: Conduit nuts

- Remove the screw securing the Primary Unit to the mounting bracket and remove the Primary Unit from the mounting bracket.

**NOTE**

If you remove the Primary Unit and do not immediately install a new one, use insulation tape to isolate any exposed wires.

- Place the new Primary Unit on the mounting bracket; insert the screw securing the Primary Unit through the right side of the heat sink and into the bracket.
- Connect the DC, AC wires and the communication connectors to the Primary Unit.
- For a 3 unit inverter reconnect the AC, DC and comm cables from the Connection Unit to the right Secondary Unit.
- Close the Primary Unit cover.
- Perform the commissioning steps as described in *Activating, Commissioning and Configuring the System Using SolarEdge Inverter SetApp* on page 35.
- In the monitoring platform, use the **Replace** button in the **logical layout** tab (in site Admin).

Replacing a Secondary Unit

- Turn OFF the Inverter ON/OFF switch, and wait until the green LED is blinking, indicating that the DC voltage is safe (<50V), or wait five minutes before continuing to the next step.

**WARNING!**

If you cannot see Primary Unit LEDs or you cannot connect to the Primary Unit, or if the red LED light is on indicating a malfunction, wait five minutes for the input capacitors of the inverter to discharge.

- Disconnect all the connectors on the bottom of the Secondary Unit.
- Remove the screw securing the Secondary Unit to the mounting bracket and remove the Secondary Unit from the mounting bracket.
- Place the new Secondary Unit on the mounting bracket.
- Insert one of the supplied screws through the outer side of the heat sink and into the bracket.
- Perform pairing as described in *Activating, Commissioning and Configuring the System Using SolarEdge Inverter SetApp* on page 35.

Replacing the Connection Unit

Removing the Connection Unit

- Turn OFF the Inverter ON/OFF switch, and wait until the green LED is blinking, indicating that the DC voltage is safe (<50V), or wait five minutes before continuing to the next step.

**WARNING!**

If you cannot see Primary Unit LEDs or you cannot connect to the Primary Unit, or if the red LED light is on indicating a malfunction, wait five minutes for the input capacitors of the inverter to discharge.

- Disconnect the AC to the inverter by turning OFF the circuit breakers on the distribution panel.

3. Open the Connection Unit cover:
 - Release the six Allen screws of the cover.
 - Tilt the top of the cover towards you.
 - Slide the cover down and remove it.



CAUTION! When removing the cover, make sure not to damage internal components. SolarEdge will not be held responsible for any components damaged as a result of incautious cover removal.

4. Disconnect the Secondary Unit(s) from the Connection Unit .
5. Disconnect the communication connector from the Primary Unit communication board.
6. Unscrew the two conduit nuts in the Primary Unit securing the Connection Unit to it, see *Figure 44*.
7. Open the Connection Unit cover and disconnect the DC, AC and communication wires.
8. Release the Connection Unit bracket from the wall.
9. Carefully remove the Connection Unit with its mounting bracket from the wall.

Installing a New Connection Unit

1. Position the new Connection Unit below the inverter and from the inside of the Primary Unit grab the AC and DC wires extending from the switch conduits.
2. Securely screw the two conduit nuts onto the conduit ends in the inverter.
3. Attach the Connection Unit with its bracket to the wall and tighten its screw.

Connecting the Connection Unit to the Primary Unit

1. Connect the DC, as follows, see *Figure 43*:
 - Connect the red wire to any of the DC+ terminals in the inverter.
 - Connect the black wire to any of the DC- terminals in the inverter.
2. Connect the communication wire to the communication board.
3. Connect the AC wires according to the labels on the AC terminal blocks, as follows:

Three Phase Inverter	
Wire type	Connect to terminal
Line 1	L1
Line 2	L2
Line 3	L3
PE (grounding)	
Neutral	N

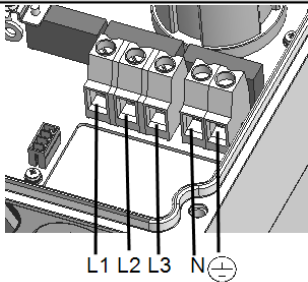

L1 L2 L3 N

Figure 45: Primary Unit AC terminals

4. Tighten the screws of each terminal with a torque of 1.2-1.5 N*m / 0.88-1.1 lb.*ft.
5. Verify that there are no unconnected wires at the output of the Connection Unit and that any unused terminal screws are tightened.

6. Connect the DC and AC wires to the Connection Unit. Refer to *Connecting the AC and Strings to the Connection Unit* on page 29 .
7. Ensure proper cable entry sealing; inspect the entire cable run and use standard sealants to avoid water penetration.

Replacing Power Optimizers

1. Turn OFF the inverter ON/OFF switch, and wait until the LCD green light is blinking, or wait five minutes before continuing to the next step.



WARNING!

If a malfunction is indicated by the LEDs, wait five minutes for the input capacitors of the inverter to discharge.

2. Turn OFF the AC breaker and distribution panel on the main distribution panel.
3. Disconnect and replace the necessary power optimizers.
4. Perform pairing
5. In the monitoring platform, use the **Replace** button in the **logical layout** tab (in site Admin). Replace the serial number of the removed power optimizer with the serial number of the newly installed power optimizer. Refer to <https://www.solaredge.com/sites/default/files/se-monitoring-portal-site-admin.pdf>

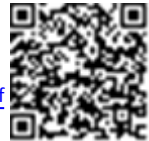

Three Phase Inverter with synergy technology - Technical Specifications

	Three Phase Inverters			Three Phase Inverters for the Medium Voltage Grid		Unit
	SE50K ¹	SE55K	SE82.8K	SE66.6K ²	SE100K ²	
Output						
Rated AC power output	50000 ³	55000	82800	66600	100000	VA
Maximum AC power output	50000 ³		82800	66600	100000	VA
AC output voltage – line to line / line to neutral (nominal)	380/220;400/230 55000			480/277		Vac
AC output voltage range line to line range: line to neutral range	318-460;184-264.5			432/528 /249.3-304.7		Vac
AC frequency	50/60± 5					Hz
Maximum continuous output current (per phase) @Vac.nom	76	80	120	-	-	A
Maximum continuous output current (per phase) @277V	-	-	-	80	120	

¹Available in the UK and Israel only

²The SE66.6K and SE100K models require a medium voltage transformer

³49990 in the UK

	Three Phase Inverters			Three Phase Inverters for the Medium Voltage Grid		Unit
	SE50K ¹	SE55K	SE82.8K	SE66.6K ²	SE100K ²	
Grids supported – three phase ³	3 / N / PE (WYE with Neutral)					
Maximum Residual Current Injection	250 per unit ⁴			250 per unit		
Utility monitoring, islanding protection, configurable Power Factor, country configurable thresholds	Yes					
Input						
Maximum DC power (Module STC)	67500 / 33750	74500/37250	11750/37250	90000/45000	135000/45000	W
Transformer-less, ungrounded	Yes					
Maximum input voltage	1000					Vdc
Nominal DC input voltage	750			850		Vdc
Maximum input current	74	80	120	80	120	Acd

¹Available in the UK and Israel only

²The SE66.6K and SE100K models require a medium voltage transformer

³In some countries, the SolarEdge three phase inverters can be connected to delta grids, refer to https://www.solaredge.com/sites/default/files/se_three_phase_inverters_for_delta_grids.pdf, and to Supported Countries application note to confirm compatibility http://www.solaredge.com/sites/default/files/se_inverters_supported_countries.pdf

⁴If an external RCD is required, its trip value must be $\geq 300\text{mA}$ per unit ($\geq 600\text{mA}$ for SE50K/SE55K; $\geq 900\text{mA}$ for SE82.8K)

	Three Phase Inverters			Three Phase Inverters for the Medium Voltage Grid		Unit
	SE50K ¹	SE55K	SE82.8K	SE66.6K ²	SE100K ²	
Reverse-polarity protection	Yes					
Ground-fault isolation detection	350kΩ Sensitivity per unit ³					
Maximum inverter efficiency	98.3			98.1		%
European weighted efficiency	98					%
Night-time power consumption	< 12					W

¹Available in the UK and Israel only

²The SE66.6K and SE100K models require a medium voltage transformer

³Where permitted by local regulations

	Three Phase Inverters			Three Phase Inverters for the Medium Voltage Grid		Unit
	SE50K ¹	SE55K	SE82.8K	SE66.6K ²	SE100K ²	
Additional Features						
Supported communication interfaces	RS485, Ethernet, Cellular GSM (optional)					
RS485 Surge Protection	Built-in					
DC Safety Unit						
DS Disconnect	1000V / 2 x 40A		1000V / 3 x 40A	1000V / 2 x 40A	1000V / 3 x 40A	
DC Surge Protection	Optional, Type II field replaceable					
DC Fuses on Plus & Minus	Optional, 30A					
Standard Compliance						
Safety	IEC-62109, AS3100					
Grid connection standards ³	VDE -AR-N-4105, G59/3, AS-4777, EN50438, CE-1, VDE 0126-1-1, CEI-016, BDEW					
Emissions	IEC61000-6-2, IEC61000-6-3, IEC61000-3-11, IEC61000-3-12, FCC part 15 class B					
RoHS	Yes					
Installation Specifications						
Number of units	2		3	2	3	mm
AC Output Cable	Cable range AC - diameter 20-38; Cable range PE - diameter 10-16					mm

¹Available in the UK and Israel only

²The SE66.6K and SE100K models require a medium voltage transformer

³For all standards refer to the Certifications category in <http://www.solaredge.com/groups/support/downloads>.

	Three Phase Inverters			Three Phase Inverters for the Medium Voltage Grid		Unit
	SE50K ¹	SE55K	SE82.8K	SE66.6K ²	SE100K ²	
AC Output Cable	Cable range AC - diameter 22-32; Cable range PE - diameter 10-16		Cable range AC - diameter 20-38; Cable range PE - diameter 10-16	Cable range AC - diameter 22-32; Cable range PE - diameter 10-16	Cable range AC - diameter 20-38; Cable range PE - diameter 10-16	
DC input ³	6 x strings; 4-10mm ² Glands DC wire, gland outer diameter 5-10mm/ 2MC4 pairs per unit		pairs 9x strings; 4-10mm ² Glands DC wire, gland outer diameter 5-10mm/ 3MC4 pairs per unit	6 strings, 4-10mm ² DC wire, gland outer diameter 5-10mm/ 2MC4 pairs per unit	9 strings, 4-10mm ² DC wire, gland outer diameter 5-10mm/ 3MC4 pairs per unit	
AC Output wire	Aluminum or Copper; L,N: Up to 70, PE: Up to 35		Aluminum or Copper; L,N: Up to 95, PE: Up to 50	Aluminum or Copper; L,N: Up to 70, PE: Up to 35	Aluminum or Copper; L,N: Up to 95, PE: Up to 50	
Dimensions (HxWxD)	Primary Unit: 940x315x260 ; Secondary Unit: 540x315x260					mm
Weight	Primary Unit: 48; Secondary Unit: 45					kg
Operating humidity	Relative Humidity up to 100%					%
Operating temperature range	-40 to + 60 ⁴					°C
Cooling	Fan (user replaceable)					

¹Available in the UK and Israel only

²The SE66.6K and SE100K models require a medium voltage transformer

³Single input option per unit (up to 25mm²) available

³ The DC input type, MC4 or glands, depends on the part number ordered. Inverter with glands P/N: SExxK-xx0P0BNG4, Inverter with MC4 P/N: SExxK-xx0P0BNU4

⁴De-rating from 50°C, refer to the application note at the following link: <http://www.solaredge.com/files/pdfs/se-temperature-derating-note.pdf>

	Three Phase Inverters			Three Phase Inverters for the Medium Voltage Grid		Unit
	SE50K ¹	SE55K	SE82.8K	SE66.6K ²	SE100K ²	
Noise	< 60					dBA
Protection rating	IP65 Outdoor and indoor					

Recommended circuit breaker/ fuse size to use at the grid connection point:

Inverter	Maximum output current (A)	Minimum fuse Rating (A)	Maximum fuse rating (A)
SE50k	72.5	100	125
SE55k	80	100	125
SE82.8K	120	150	200
SE66.6k	80	100	125
SE100k	120	150	200

¹Available in the UK and Israel only

²The SE66.6K and SE100K models require a medium voltage transformer

If you have technical queries concerning our products, please contact our support through SolarEdge service portal:

<http://www.solaredge.com/service/support>

Australia (+61)	1800 465 567
APAC (Asia Pacific) (+972)	073 240 3118
Benelux NL (+31)	0800-7105
BE (+32)	0800-76633
China (+86)	21 6212 5536
DACH and Rest of Europe (+49)	089 454 59730
France and Belgium (+33)	0800 917 410
Italy (+39)	0422 053700
Japan (+81)	03 6262 1223
Netherlands (+31)	0800 0221 089
New Zealand (+64)	0800 144 875
US & Canada (+1)	510 498 3200
United Kingdom (+44)	0800 028 1183
Greece (+49)	89 454 59730
Israel (+972)	073 240 3122
Middle East & Africa (+972)	073 240 3118
South Africa (+27)	0800 982 659
Turkey (+90)	216 706 1929
Worldwide (+972)	073 240 3118

Email to: support@solaredge.com

www.solaredge.com

solaredge



MAN-01-00402_1.1