



# User manual

## Solar Grid-tied Inverter

Product Model: SOFAR I. 1K~3KTL



---

---

## Contents

Preface.....	III
1. Basic safety information.....	- 1 -
1.1. Safety instructions.....	- 1 -
1.2. Symbols and signs.....	- 4 -
2. Product characteristics.....	- 6 -
2.1. Product dimensions.....	- 6 -
2.2. Function description.....	- 8 -
2.3. Efficiency curve.....	- 10 -
3. Installation.....	- 11 -
3.1. Installation Process.....	- 11 -
3.2. Checking Before Installation.....	- 12 -
3.3. Tools.....	- 14 -
3.4. Determining the Installation Position.....	- 15 -
3.5. Moving the SOFAR 1.1K~3KTL.....	- 16 -
3.6. Installing SOFAR 1.1K~3KTL.....	- 17 -
4. Electrical Connections.....	- 19 -
4.1. Electrical connection.....	- 20 -
4.2. Connecting PGND Cables.....	- 20 -
4.3. Connecting DC Input Power Cables.....	- 22 -
4.4. Connecting AC Output Power Cables.....	- 24 -
4.5. RS485,CT,inverter logic interface connection.....	- 28 -
4.6. WIFI/Ethernet module installation.....	- 34 -
4.7. Communication method.....	- 34 -
5. Commissioning of inverter.....	- 38 -
5.1. Safety inspection before commissioning.....	- 38 -
5.2. Start inverter.....	- 38 -
6. Operation interface.....	- 39 -
6.1. Operation and Display Panel.....	- 39 -
6.2. Standard Interface.....	- 40 -
6.3. Main Interface.....	- 43 -
6.4. Update Software online.....	- 48 -
7. Trouble shooting and maintenance.....	- 50 -
7.1. Trouble shooting.....	- 50 -
7.2. Maintenance.....	- 56 -
8. Technical data.....	- 58 -
8.1. Input parameters (DC).....	- 58 -
8.2. Output parameters (AC).....	- 59 -
8.3. Efficiency,Protection and Communication.....	- 60 -
8.4. General Date.....	- 61 -
9. Quality Assurance.....	- 62 -

## **Notice**

This manual contains important safety instructions that must be followed during installation and maintenance of the equipment.

### **Save these instructions!**

This manual must be considered as an integral part of the equipment. The manual must always accompany the equipment, even when it is transferred to another user or field.

## **Copyright Declaration**

The copyright of this manual belongs to Shenzhen SOFARSOLAR Co., Ltd. Any corporation or individual should not plagiarize, partially copy or fully copy it (including software, etc.), and no reproduction or distribution of it in any form or by any means. All rights reserved.

SOFARSOLAR reserves the right of final interpretation. This manual is subject to change according to user's or customer's feedback. Please check our website at <http://www.sofarsolar.com> for latest version.

# *Preface*

## **Outline**

Please read the product manual carefully before installation, operation or maintenance. This manual contains important safety instructions and installation instructions that must be followed during installation and maintenance of the equipment.

## **Scope**

This product manual describes the installation, electrical connections, commissioning, maintenance and troubleshooting of SOFAR 1.1K~3KTL inverters:

SOFAR 1.1KTL    SOFAR 1.6KTL

SOFAR 2.2KTL    SOFAR 2.7KTL    SOFAR 3KTL






Keep this manual where it will be accessible at all times.

## **Target Group**

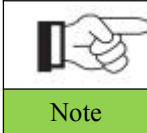
This manual is intended for qualified electrical technical personnel who are responsible for inverter installation and commissioning in the PV power system and PV plant operator.

## **Symbols Used**

This manual provides safety operation information and uses the symbol in order to ensure personal and property security and property security and use inverter efficiently when operating the inverter. You must understand these emphasized information to avoid the personal injury and property loss. Please read the following symbols used in this manual carefully.

	Danger indicates a hazardous situation which, if not avoided, will result in death or serious injury.
Danger	
	Warning indicates a hazardous situation which, if not avoided, could result in death or serious injury.
Warning	
	Caution indicates a hazardous situation which, if not avoided, could result in minor or moderate injury.
Caution	
	Attention indicates potential risks which, if not avoided, may lead to equipment fault or property damage.
Attention	
	Note provides tips that are valuable for the optimal operation of the product.
Note	

# *1. Basic safety information*



If you have any question or problem when you read the following information, please contact Shenzhen SOFARSOLAR Co., Ltd.

## **Outlines of this chapter**

### **Safety instruction**

It mainly introduce the safety instruction when install and operate the equipment.

### **Symbols and signs**

It mainly introduce the safety symbols on the inverter.

## **1.1. Safety instructions**

Read and understand the instructions of this manual, and be familiar with relevant safety symbols in this chapter, then start to install and troubleshoot the equipment.

According to the national and state requirements, before connecting to the electrical grid, you must get permission from the local electrical grid operation can only be performed by qualified electrical engineer.

Please contact the nearest authorized service center if any maintenance or repair is needed. Contact your distributor for the information of the nearest authorized service center. Do NOT repair it by yourself, it may cause injury or property damage.

Before installing and maintaining the equipment, you should turn the DC switch OFF to cut off the high voltage DC of the PV array. You can also turn the switch in the PV combiner box OFF to cut off the high voltage DC. Otherwise, serious injury may be caused.

## Qualified persons

The customer must make sure the operator has the necessary skill and training to do his/her job. Staff in charge of using and maintaining the equipment must be skilled, aware and mature for the described tasks and must have the reliability to correctly interpret what is described in the manual. For safety reason only a qualified electrician, who has received training and / or has demonstrated skills and knowledge in construction and in operation of this unit, can install this inverter. Shenzhen SOFARSOLAR Co., Ltd does not take any responsibility for the property destruction and personal injury because of any incorrect use.

## Installation requirements

Please install inverter according to the following section. Fix the inverter on an appropriate objects with enough load bearing capacity (such as walls, PV racks etc.), and ensure that inverter is vertical placed. Choose a place suitable for installing electrical devices. And assure there is enough fire exit space, convenient for maintenance. Maintain proper ventilation to ensure enough air cycle to cool the inverter.



## Transport requirements





If you find packing problems that may cause the damage of the inverter, or find any visible damage, please immediately notice the responsible transportation company. You can ask solar equipment installation contractor or Shenzhen

SOFARSOLAR Co.Ltd for help if necessary.



Transport of the equipment, especially by road, must be carried out with by suitable ways and means for protecting the components (in particular, the electronic components) from violent shocks, humidity, vibration, etc.

## Electric connection

Please comply with all the current electrical regulations about accident prevention in dealing with the solar invert.



	Before the electrical connection, make sure to use opaque material to cover the PV modules or to disconnect PV array DC switch. Exposure to the sun, PV array will produce a dangerous voltage!
<b>Danger</b>	
	All installation accomplished only by professional electrical engineer!
<b>Warning</b>	<ul style="list-style-type: none"> <li>• must be trained;</li> <li>• Completely read the manual operation and understand relevant matter.</li> </ul>
	Get permission from the local electrical grid operator, complete all electrical connections by professional electrical engineer, then connect inverter to electrical grid.
<b>Attention</b>	
	It's forbidden to remove the tamper evident label, or open the inverter. Otherwise Sofarsolar will not provide warranty or maintenance!
<b>Note</b>	

## Operation

	Touching the electrical grid or the terminal of the equipment may lead to electrocution or fire!
<b>Danger</b>	<ul style="list-style-type: none"> <li>• Don't touch the terminal or conductor connected to the electrical grid.</li> <li>• Pay attention to any instructions or safety documents related to grid connection.</li> </ul>
	Some internal components will be very hot when inverter is working. Please wear protective gloves!
<b>Attention</b>	

## Maintenance and repair



	<p>Before any repair work, turn OFF the AC circuit breaker between the inverter and electrical grid first, then turn OFF the DC switch. After turning OFF the AC circuit breaker and DC switch, wait for 5 minutes at least before carrying out any maintenance or repair work.</p>
<b>Danger</b>	
	<p>Inverter should work again after removing any faults. If you need any repair work, please contact with the local authorized service center.</p> <p>Can't open the internal components of inverter without authorized. Shenzhen SOFARSOLAR Co., Ltd. does not take any responsibility for the losses from that.</p>
<b>Attention</b>	


### EMC / noise level of inverter

Electromagnetic compatibility (EMC) refers to that one electrical equipment functions in a given electromagnetic environment without any trouble or error, and impose no unacceptable effect upon the environment. Therefore, EMC represents the quality characters of an electrical equipment.




The inherent noise-immune character: immunity to internal electrical noise.

External noise immunity: immunity to electromagnetic noise of external system.

Noise emission level: influence of electromagnetic emission upon environment.









	<p><b>Electromagnetic radiation from inverter may be harmful to health!</b></p> <p>Please do not continue to stay around the inverter in less than 20 cm when inverter is working.</p>
<b>Danger</b>	

## 1.2. Symbols and signs

	<p>Caution of burn injuries due to hot enclosure!</p> <p>You can only touch the screen and pressing key of the inverter while it's working.</p>
<b>Caution</b>	
	<p>PV array should be grounded in accordance to the requirements of the local electrical grid operator!</p> <p>We suggest that all PV module frames and inverter are reliably grounded to protect the PV system and personnel security.</p>
<b>Attention</b>	
	<p>Ensure input DC voltage &lt; Max. DC voltage .Over voltage may cause permanent damage to inverter or other losses, which will not be included in warranty!</p>
<b>Warning</b>	

## Signs on the inverter

There are some symbols which are related to security on the inverter. Please read and understand the content of the symbols, and then start the installation.

	There is a residual voltage in the inverter! Before opening the equipment, operator should wait for five minutes to ensure the capacitor is discharged completely.
	Caution, risk of electric shock.
	Caution hot surface.
	Comply with the Conformite Europeenne (CE) certification.
	Grounding point.
	Please read this manual before install SOFAR 1.1K~3KTL.
	This indicates the degree of protection of the equipment according to IEC standard 70-1 (EN 60529 June 1997).
	Positive pole and negative pole of the input voltage (DC).

## 2. Product characteristics

### Outlines of this chapter

#### Product dimensions

It introduces the field of use, and the overall dimensions of SOFAR 1.1K~3KTL inverters.

#### Function description

It introduces how SOFAR 1.1K~3KTL inverters work and the function modules inside.

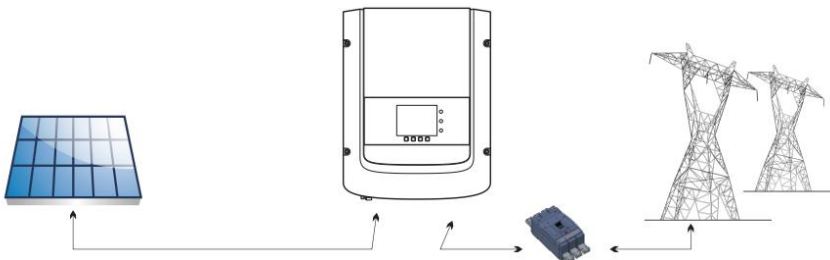
#### Efficiency curves

It introduces the efficiency curves of in the inverter.

### 2.1. Product dimensions

SOFAR 1.1K~3KTL is a single MPPT grid-tied PV inverter which converts the DC power generated by PV arrays into sine wave single-phase AC power and feeds it to the public electrical grid, AC circuit breaker (refer to Section 4.4) and DC switch used as disconnect device, and the disconnect device shall be easily accessible.

Figure2-1 PV Grid-tied System



SOFAR 1.1K~3KTL inverters can only be used with photovoltaic modules

that do not require one of the poles to be grounded. The operating current during normal operation must not exceed the limits specified in the technical specifications. Only the photovoltaic modules can be connected to the input of the inverter (do not connect batteries or other sources of power supply).

The choice of optional parts of inverter should be made by a qualified technician who knows the installation conditions clearly.

Overall dimensions: L×W×H=404.5mm×314mm×135.5mm

Figure 2-2 Front view and left view dimensions

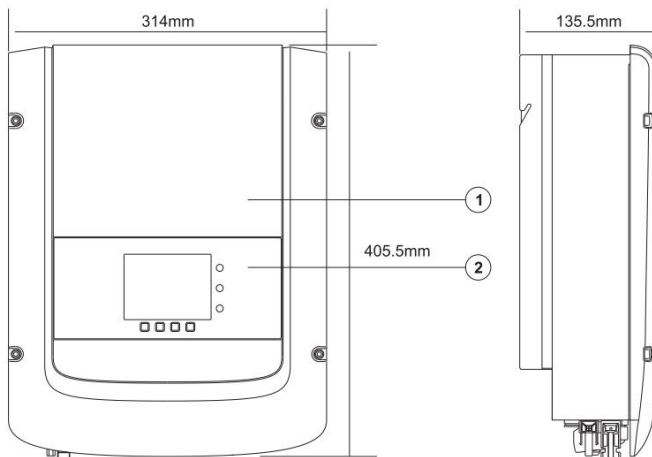


Figure 2-3 Back view and Bracket dimensions

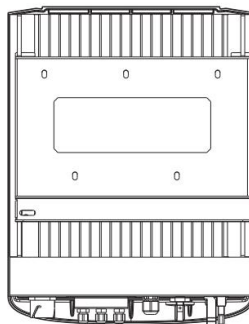
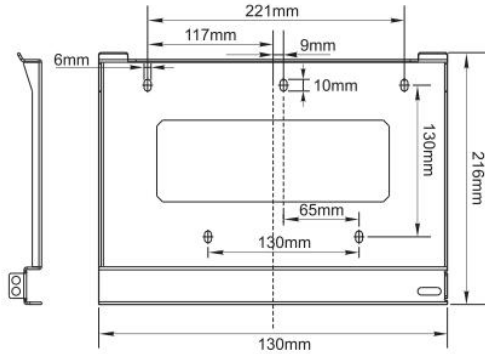
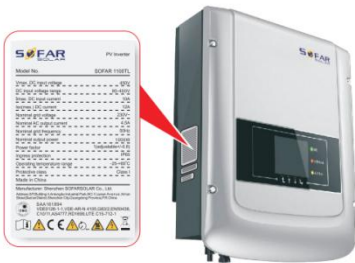


Figure 2-4 Bracket dimensions of SOFAR 1.1K~3KTL



◆ Labels on the equipment



The labels must NOT be hidden with objects and extraneous parts (rags, boxes, equipment, etc.); they must be cleaned regularly and kept visible at all times.

## 2.2. Function description

DC power generated by PV array is filtered through Input Board before entering into Power Board. Input Board also offer functions such as insulation impedance detection and input DC voltage / current detection. DC power is converted to AC power by Power Board. AC power is filtered through Output Board then AC power is fed into the grid. Output Board also offer functions such as grid voltage / output current detection, GFCI and output isolation relay. Control Board provides the auxiliary power, controls the operation state of inverter and shows the operation status by Display Board. Display Board displays fault code

when inverter is in abnormal operation conditions. At the same time, Control Board can trigger the relay so as to protect the internal components.

## **Function module**

### **A. Energy management unit**

This control can be used to switch the inverter on/off through an external (remote) control.

### **B. Feeding reactive power into the grid**

The inverter is able to produce reactive power and can therefore feed it into the grid through the setting of the phase shift factor. Feed-in management can be controlled directly by the grid company through a dedicated RS485 serial interface.

### **C. Limiting the active power fed into the grid**

The inverter, if enabled can limit the amount of active power fed into the grid by the inverter to the desired value (Expressed as a percentage).

### **D. Self power reduction when grid is over frequency**

When the grid frequency is higher than the limited value, inverter will reduce output power which is necessary for the grid stability.

### **E. Data transmission**

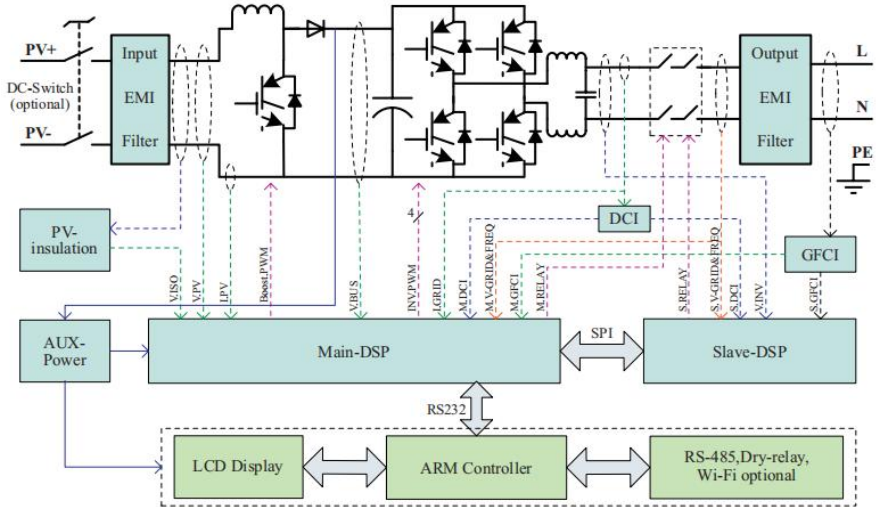
The inverter or a group of inverters may be monitored remotely through an advanced communication system based on RS-485 serial interface, or remotely via the WIFI.

### **F. Software update**

SD card is used for updating the firmware.

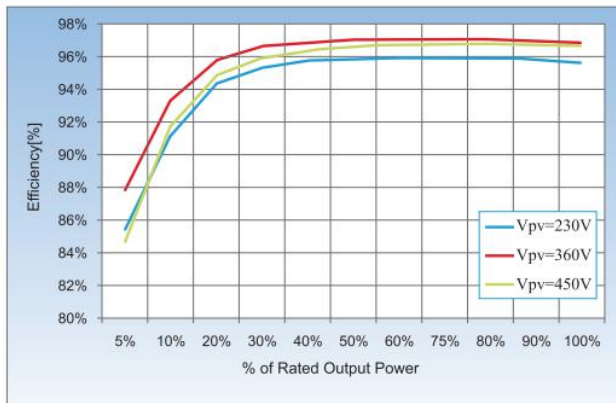
## **Electrical block diagram**

Figure2-5 Electrical block diagram



## 2.3. Efficiency curve

Efficiency curve of the SOFAR 3000TL






# 3. Installation

## Outlines of this chapter

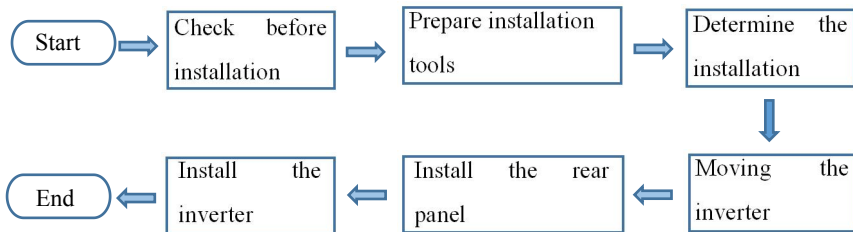
This topic describes how to install the SOFAR 1.1K~3KTL .

### Installation notes

 <b>Danger</b>	<p>Do NOT install the SOFAR 1.1K~3KTL on flammable material.</p> <p>Do NOT install the SOFAR 1.1K~3KTL in an area used to store Flammable or explosive material.</p>
 <b>Caution</b>	<p>The enclosure and heat sink are very hot while the inverter is working, therefore do NOT install the SOFAR 1.1K~3KTL in places where you might touch them inadvertently.</p>
 <b>Attention</b>	<p>Consider the weight of SOFAR1.1K~3KTL when transporting and moving the inverters.</p> <p>Choose an appropriate mounting position and surface.</p> <p>Assign at least two persons to install the inverter.</p>

## 3.1. Installation Process

Figure3-1 Installation flowchart





## 3.2. Checking Before Installation


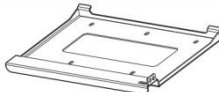
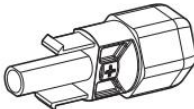
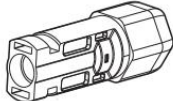
### Checking Outer Packing Materials



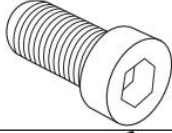




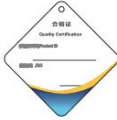
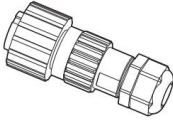
Packing materials and components may be damaged during transportation. Therefore, check the outer packing materials before installing the inverter. Check the outer packing materials for damage, such as holes and cracks. If any damage is found, do not unpack the SOFAR 1.1K~3KTL and contact the dealer as soon as possible. You are advised to remove the packing materials within 24 hours before installing the SOFAR 1.1K~3KTL inverter.

### Checking Deliverables

After unpacking the inverter, check whether deliverables are intact and complete. If any damage is found or any component is missing, contact the dealer.

Table3-1 shows the components and mechanical parts that should be delivered.



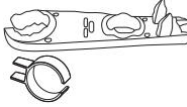
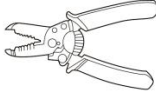

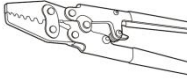
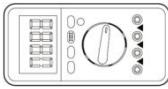


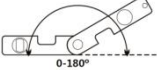
NO.	Picture	Description	Quantity
1		SOFAR 1.1K~3KTL	1pcs
2		Rear panel	1pcs
3		PV+ input terminal	1pcs
4		PV- input terminal	1pcs

5		Metal terminals secured to PV+ input power cables	1pcs
6		Metal terminals secured to PV- input power cables	1pcs
7		M5Hexagon screws	2pcs
8		Expansion bolts	7pcs(spare 2pcs)
9		Self-tapping screw	5pcs
10		Manual	1pcs
11		The warranty card	1pcs
12		Registration Form	1pcs
13		AC output terminal	1pcs

### 3.3. Tools

Prepare tools required for installation and electrical connections.

Table 3-2 shows the tools required for installation and electrical connections.

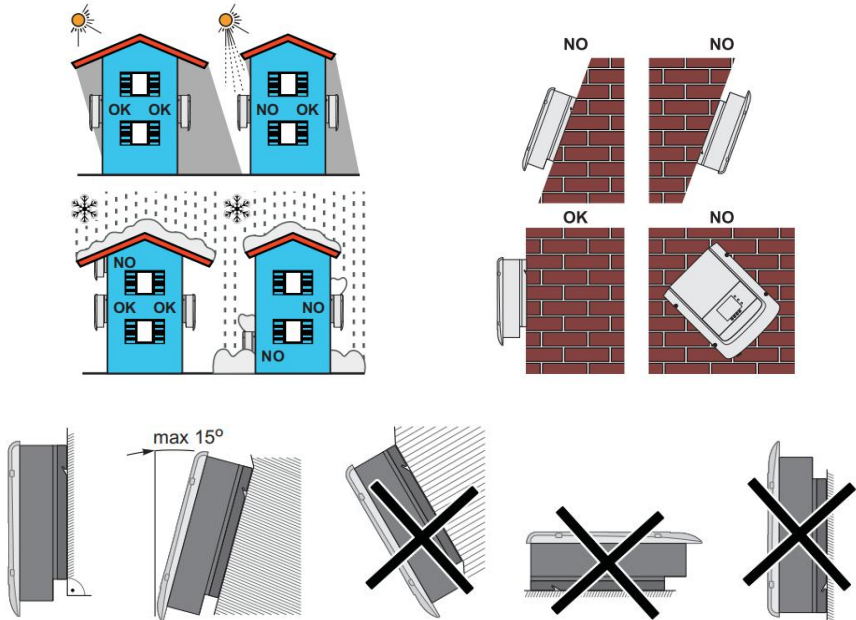
NO.	Tool	Model	Function
1		Hammer drill Recommend drill dia. 6mm	Used to drill holes on the wall.
2		Screwdriver	wiring
3		Removal tool	Remove PV termin
4		Wire stripper	Strip wire
5		4mm Allen Wrench	Turn the screw to connect rear panel with inverter.
6		Crimping tool	Used to crimp power cables
7		Multi-meter	Used to check grounding
8		Marker	Used to mark signs
9		Measuring tape	Used to measure distances
10		Level	Used to ensure that the rear panel is properly installed

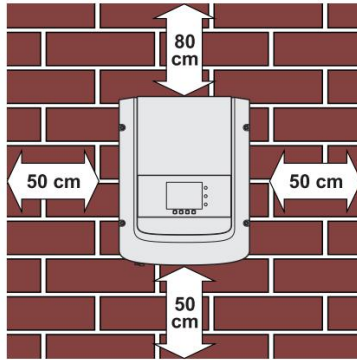
11		ESD gloves	Operators wear
12		Safety goggles	Operators wear
13		Anti-dust respirator	Operators wear

### 3.4. Determining the Installation Position

Determine an appropriate position for installing the SOFAR 1.1K~3KTL inverter. Comply with the following requirements when determining the installation position:

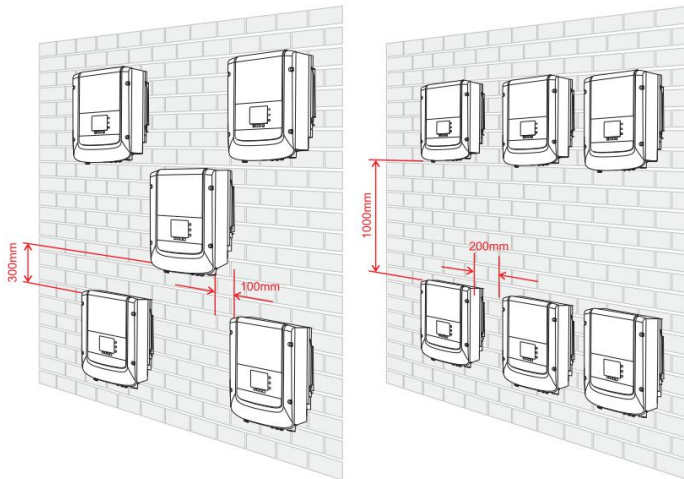
Figure3-2 Installation Requirements





clearance for single SOFAR 1.1K~3KTL inverter

Installation of multiple SOFAR 1.1K~3KTL inverter



### 3.5. Moving the SOFAR 1.1K~3KTL

This topic describes how to move the to the installation position Horizontally SOFAR 1.1K~3KTL.

**Step 1** Open the packaging, insert hands into the slots on both sides of the

inverter and hold the handles, as shown in Figure 3-3 and Figure 3-4.

Figure 3-3 Moving the inverter (1)

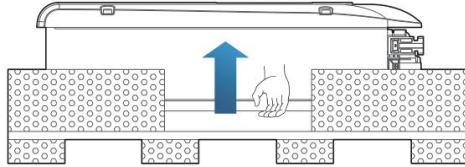
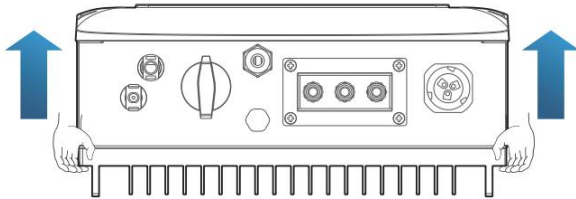



Figure 3-4 Moving the inverter (2)



**Step 2** Lift the SOFAR 1.1K~3KTL from the packing case and move it to the installation position.

 <b>Attention</b>	<p>To prevent device damage and personal injury, keep balance when moving the inverter because the inverter is heavy.</p> <p>Do not put the inverter with its wiring terminals contacting the floor because the power ports and signal ports are not designed to support the weight of the inverter. Place the inverter horizontally.</p> <p>When placing the inverter on the floor, put foam or paper under the inverter to protect its shell.</p>
---	---

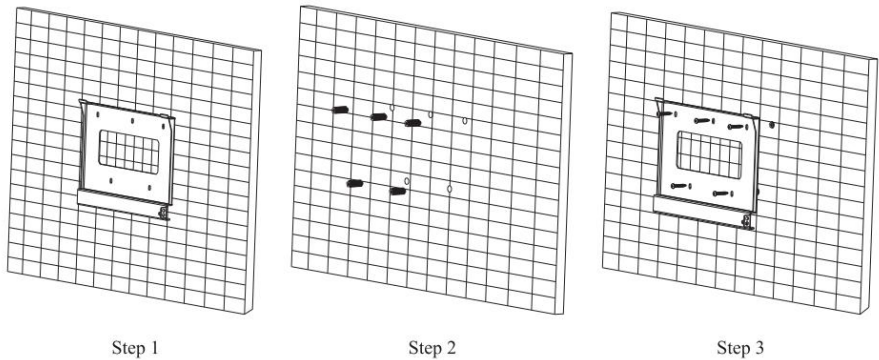
## 3.6. Installing SOFAR 1.1K~3KTL

**Step 1** Determine the positions for drilling holes, ensure the hole positions are level, then mark the hole positions using a marker pen, use the hammer drill to drill holes on the wall. Keep the hammer drill perpendicular to the wall, do not shake when drilling, so as not to damage the wall. If the error of the hole positions is too big, you need to reposition.

**Step 2** Insert the expansion bolt vertically into the hole, pay attention to the insertion depth of the expanding bolt (should be deep enough).

**Step 3** Align the rear panel with hole positions, fix the rear panel on the wall by tightening the expansion bolt with the nuts.

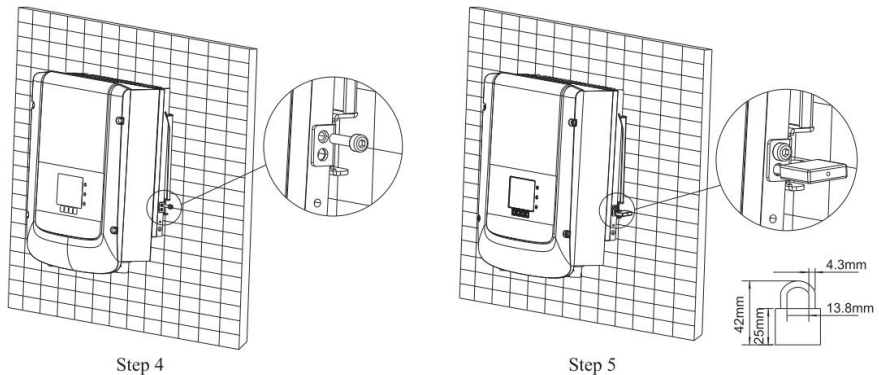
Figure 3-5



**Step 4** Hook the inverter to the rear panel. Using an M5 screw to secure the inverter to the rear panel to ensure safety.

**Step 5** You can secure the inverter to the rear panel and protect it from stealing by installing an anti-theft lock (this action is optional).

Figure 3-6






## 4. Electrical Connections

### Outlines of this chapter

This topic describes the SOFAR 1.1K~3KTL inverter electrical connections. Read this part carefully before connecting cables.

**NOTE:** Before performing electrical connections, ensure that the DC switch is OFF. Since the stored electrical charge remains in a capacitor after the DC switch is turned OFF. So it's necessary to wait for at least 5 minutes for the capacitor to be electrically discharged.

	Installation and maintenance of inverter, must be operated by professional electrical engineer.
<b>Attention</b>	
	PV modules generate electric energy when exposed to sunlight and can create an electrical shock hazard. Therefore, before connecting DC input power cable, cover PV modules using opaque cloth
<b>Danger</b>	
	For SOFAR 1.1K~1.6KTL, open-circuit voltage( $V_{oc}$ ) of module arrays connected in series must be $\leq 450V$ ; For SOFAR 2.2K~3KTL, it must be $\leq 500V$ .
<b>Note</b>	The power of PV grid-tied system which contain by several the SOFAR 1.1K~3KTL inverters must be $< 3.68kw$ in Germany.

The connected PV modules must have an IEC 61730 Class A rating		
IscPV(absolute maximum)	SOFAR1100TL	12.5A
	SOFAR1600TL	12.5A
	SOFAR2200TL	16.5A
	SOFAR2700TL	17A
	SOFAR3000TL	19A
Maximum output over current protection	SOFAR1100TL	4.5A
	SOFAR1600TL	7A
	SOFAR2200TL	9.5A
	SOFAR2700TL	11.5A
	SOFAR3000TL	13A

The decisive voltage class(DVC)

**NOTE:** The DVC is the voltage of a circuit which occurs continuously between any two

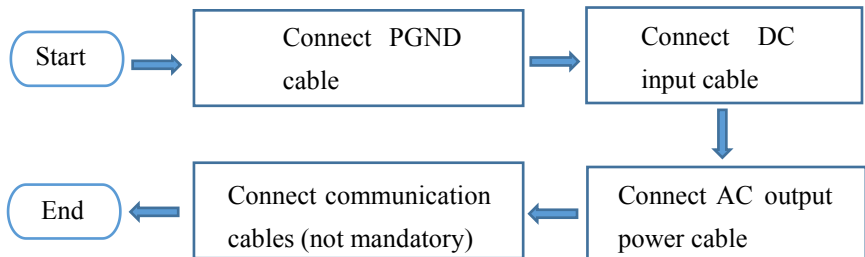


live part in the worst-case rated operating condition when used as intended.

Interface	DVC
PV input interface	DVCC
AC output interface	DVCC
SD card interface	DVCA
RS485 interface	DVCA
CT interface	DVCA
Logic interface	DVCA
WiFi/GPRS/Ethernet interface	DVCA

## 4.1. Electrical connection

Figure4-1 Shows the flowchart for connecting cables to the inverter.



## 4.2. Connecting PGND Cables

Connect the inverter to the grounding electrode using protection ground (PGND) cables for grounding purpose.



### Attention

The inverter is transformer-less, requires the positive pole and negative pole of the PV array are NOT grounded. Otherwise it will cause inverter failure. In the PV power system, all non current carrying metal parts (such as: PV module frame, PV rack, combiner box enclosure, inverter enclosure) should be connected to earth.

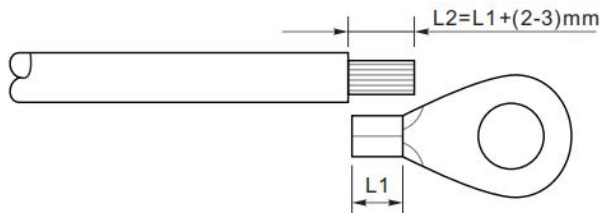
### Prerequisites:

The PGND cables are prepared (  $\geq 4\text{mm}^2$  outdoor power cables are recommended for grounding purposes),the color of cable should be yellow-green.

### Procedure:

**Step 1** Remove the insulation layer with an appropriate length using a wire stripper, as shown in Figure 4-2.

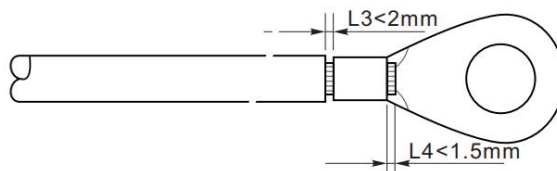
Figure4-2 Preparing a ground cable (1)



**Note:** L2 is 2 to 3mm longer than L1

**Step 2** Insert the exposed core wires into the OT terminal and crimp them by using a crimping tool, as shown in Figure 4-3.

Figure4-3 Preparing a ground cable (2)

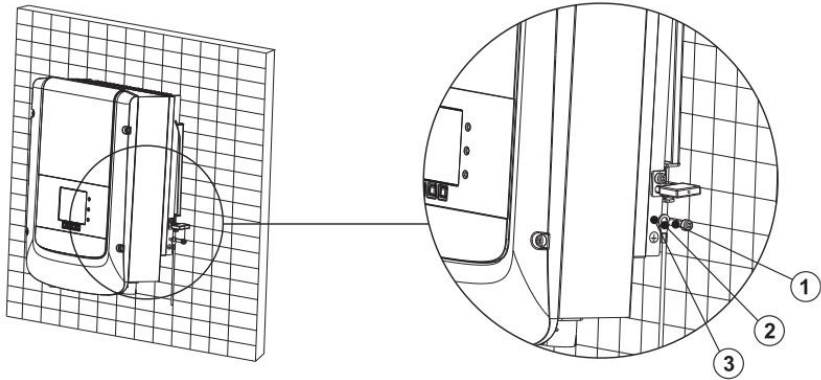


**Note 1:** L3 is the length between the insulation layer of the ground cable and the crimped part.L4 is the distance between the crimped part and core wires protruding from the crimped part.

**Note 2:** The cavity formed after crimping the conductor crimp strip shall wrap the core wires completely. The core wires shall contact the terminal closely.

**Step 3** Install the crimped OT terminal, flat washer using M5 screw, and tighten the screw to a torque of 3 N.m using an Allen wrench.

Figure4-4 Ground terminal composition



1.M5 screw、 2.OT Terminal、 3.Tapped hole

### 4.3. Connecting DC Input Power Cables

Table 4-1 Recommended DC input cable specifications

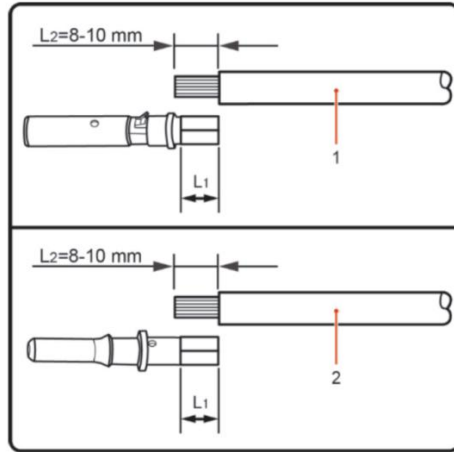
Cross-Sectional Area (mm <sup>2</sup> )		External Cable Diameter(mm)
Range	Recommended Value	
4.0~6.0	4.0	4.5~7.8

#### Procedure

**Step 1** Remove cable glands from the positive and negative connectors.

**Step 2** Remove the insulation layer with an appropriate length from the positive and negative power cables by using a wire stripper as show in Figure 4-5.

Figure 4-5 Connecting DC input power cables



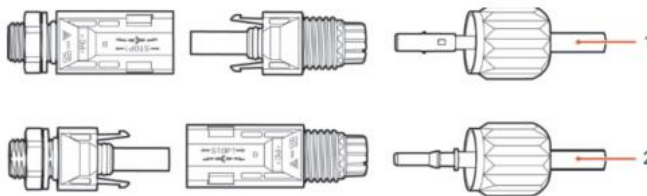
1.Positive power cable 2.Negative power cable

**Note:** L2 is 2 to 3 mm longer than L1.

**Step 3** Insert the positive and negative power cables into corresponding cable glands.

**Step 4** Insert the stripped positive and negative power cables into the positive and negative metal terminals respectively and crimp them using a clamping tool. Ensure that the cables are crimped until they cannot be pulled out by force less than 400 N, as shown in Figure 4-6.

Figure 4-6 Connecting DC input power cables



1.Positive power cable 2.Negative power cable

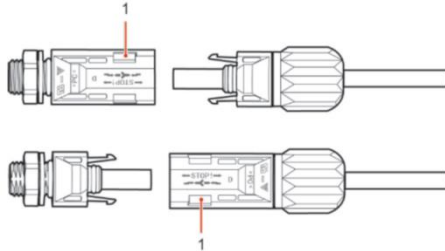
**Step 5** Insert crimped power cables into corresponding housings until you hear a "click" sound. The power cables snap into place.

**Step 6** Reinstall cable glands on positive and negative connectors and rotate

them against the insulation covers.

**Step 7** Insert the positive and negative connectors into corresponding DC input terminals of the inverter until you hear a "click" sound, as shown in Figure 4-7.

Figure 4-7 Connecting DC input power cables



1. Bayonet

**Note:** Insert the stoppers into the unused DC connectors.

### Follow-up Procedure

To remove the positive and negative connectors from the inverter, insert a removal wrench into the bayonet and press the wrench with an appropriate strength, as shown in Figure 4-8.


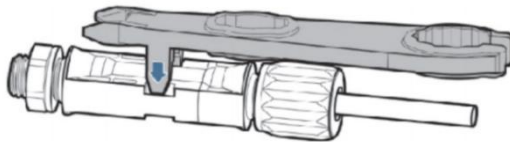
	Before removing the positive and negative connectors, ensure that the DC SWITCH is OFF.
<b>Caution</b>	


Figure 4-8 Removing a DC input connector



## 4.4. Connecting AC Output Power Cables

Connect the SOFAR 1.1K~3KTL to the AC power distribution frame (PDF) or

power grid using AC output power cables.

	<p>It is not allowed for several inverters to use the same circuit breaker. It is not allowed to connect loads between inverter and circuit breaker. AC breaker used as disconnect device, and the disconnect device shall remain readily operable.</p>
<p><b>Caution</b></p>	

**Context**

All the AC output cables used for the inverters are outdoor three-core cables. To facilitate the installation, use flexible cables. Table 4-2 lists the recommended specifications for the cables.

Figure 4-9 NOT allowed: connect loads between inverter and circuit breaker

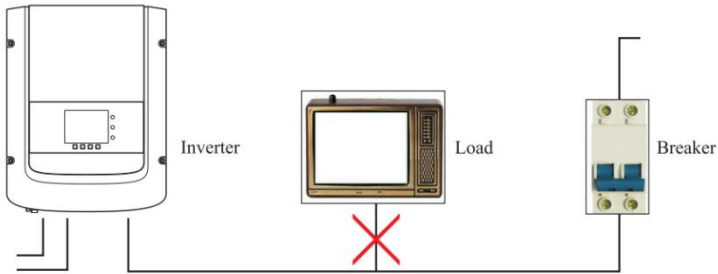
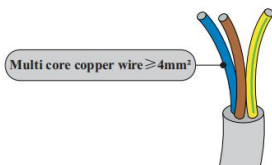


Table4-2 Recommended AC output cable specifications

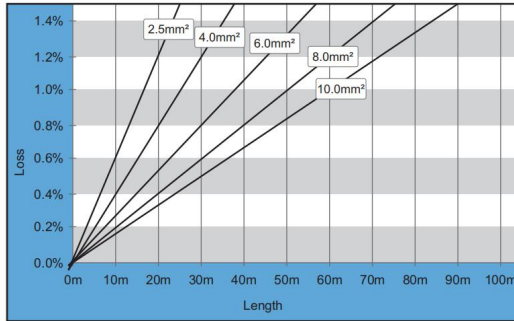
Model	SOFAR 1100TL	SOFAR 1600TL	SOFAR 2200TL	SOFAR 2700TL	SOFAR 3000TL
Cable (Copper)	≧4mm <sup>2</sup>	≧4mm <sup>2</sup>	≧4mm <sup>2</sup>	≧4mm <sup>2</sup>	≧4mm <sup>2</sup>
Breaker	16A/400V	16A/400V	25A/400V	25A/400V	25A/400V

**Multi core copper wire**



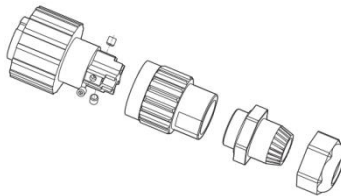
AC cable should be correctly sized to ensure the power loss in AC cable is less than 1% of the rated power. If the resistance of the AC cable is too high, it will cause a huge increase in the AC voltage, which may lead to a disconnection of the inverter from the electrical grid. The relationship between power loss in AC cable and wire length, wire cross sectional area is shown in the following figure:

Figure 4-10 wire length, wire cross sectional area and wire power loss



Inverter is equipped with IP66 AC output connector dedicated for PV inverter, customer need to make AC output cable connections by himself, and the appearance of the AC connector is shown below:

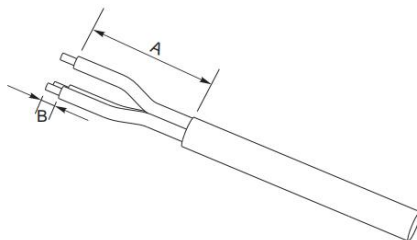
Figure 4-11 AC output connector



**AC wire connections procedure:**

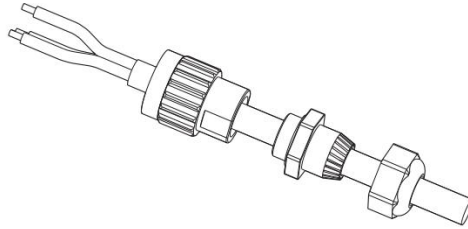
**Step 1** Select appropriate cables according to Table 4-2, Remove the insulation layer of the AC output cable using a wire stripper according to the figure shown below: A: 30~50mm B: 6~8mm;

Figure 4-12



**Step 2** Disassemble the AC connector according to the figure shown below: insert the AC output cable (with its insulation layer stripped according to step 1) through the waterproof locking cable gland;

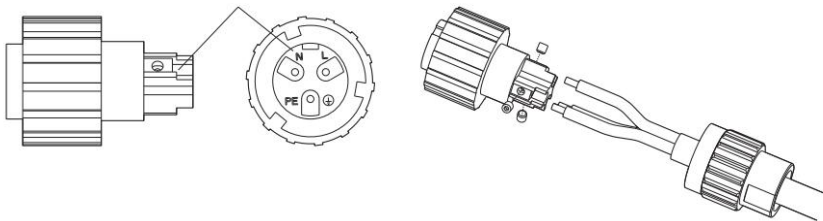
Figure 4-13



**Step 3** Connect AC output cable as per the following requirements: Connect the yellow-green wire to the hole labeled ‘PE’, fasten the wire using an Allen wrench; Connect the brown wire to the hole labeled ‘L’, fasten the wire using an Allen wrench; Connect the blue wire to the hole labeled ‘N’, fasten the wire using an Allen wrench;

Figure 4-14

L--brown, N--blue, PE--yellow/green

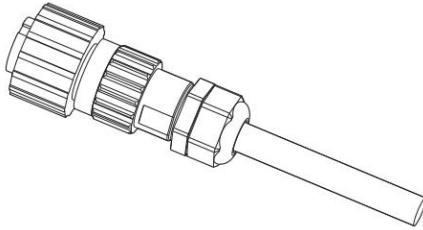


**Step 4** Secure the locking cable gland clockwise, shown as below: make sure that all the wires are securely connected;

**Step 5** Connect the AC output connector to the output wiring terminal of inverter, rotate the AC connector clockwise until the fastener reaches its designated position, as shown below.

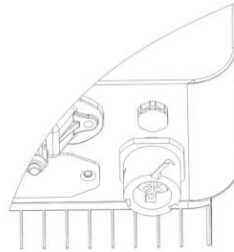


Figure 4-15



Step 4

Figure 4-16



Step 5

## 4.5. RS485,CT,inverter logic interface connection

The communication interface location of the SOFAR 1.1K~3KTL is shown in the figure below.

Figure 4-17

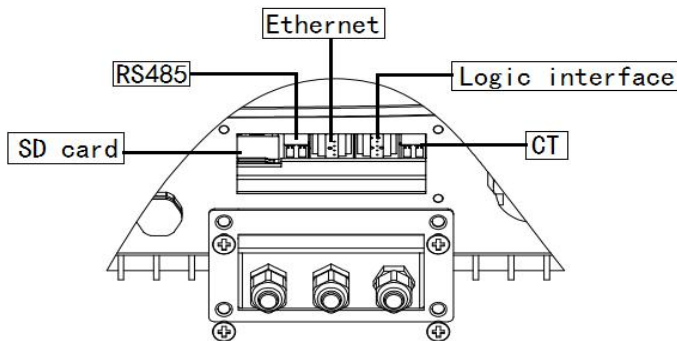
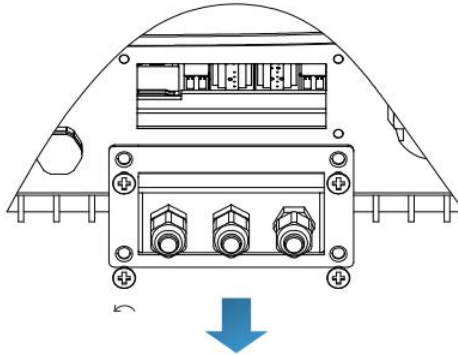


Table 4-3 Recommended communication cable size are shown below, The wiring methods are the same for RS485 and CT, this part describes their wiring methods and logic interface wiring method.

Communication function	RS485	CT
Cable size	0.5~1.5mm <sup>2</sup>	0.5~1.5mm <sup>2</sup>
Outside diameter	2.5~6mm	2.5~6mm

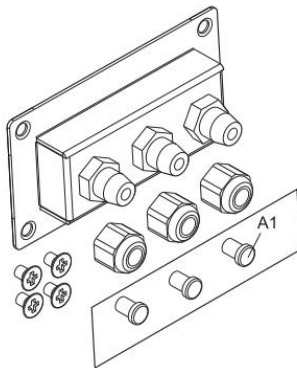
**Step1** Remove the communication waterproof cover using a screwdriver;

Figure 4-18



**Step2** Unlock the waterproof cable gland, remove the stopper in the waterproof connector;

Figure 4-19



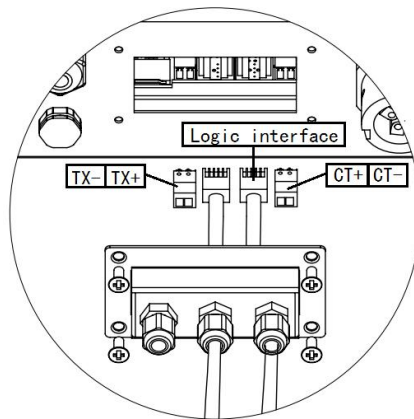
A1: Waterproof stopper

**Step3** Select appropriate cable according Table4-2,remove the insulation layer using a wire stripper, the length of the wire core is about 6mm,insert the cable through the cable gland and waterproof cover, according to Table4-4,connect the wires as per the labels, and secure the wire using a slotted screwdriver.as shown in the figure below:

Table 4-4 Function description of the communication terminals

Type	RS485		CT		Logic interface
Connector					
Label	TX-	TX+	CT+	CT-	The following table
Function	RS485 differential signal-	RS485 differential signal+	CT+	CT-	

Figure 4-20



The logic interface pin definitions and circuit connections are as follows:

The function of logical interface needs to be set on the display screen, please refer to the operation steps in section 6.3 .

Logic interface pin are defined according to different standard requirements.

(a) Logic interface for AS/NZS 4777.2:2015, also known as inverter demand response modes (DRMs).

The inverter will detect and initiate a response to all supported demand

response commands within 2 s. The inverter will continue to respond while the mode remains asserted.

Table 4-5 Function description of the DRMs terminal

Pin NO.	Color	Function
1	White and orange	DRM1/5
2	Orange	DRM2/6
3	White and green	DRM3/7
4	Blue	DRM4/8
5	White and blue	RefGen
6	Green	DRM0
7	White and brown	Pin7&Pin8 short internal
8	Brown	

NOTE: Supported DRM command: DRM0, DRM5, DRM6, DRM7, DRM8.

(b) Logic interface for VDE-AR-N 4105:2018-11, is in order to control and/or limit the inverter's output power.

The inverter can be connected to a RRCR (Radio Ripple Control Receiver) in order to dynamically limit the output power of all the inverters in the installation.

Figure 4-21 Inverter – RRCR Connection

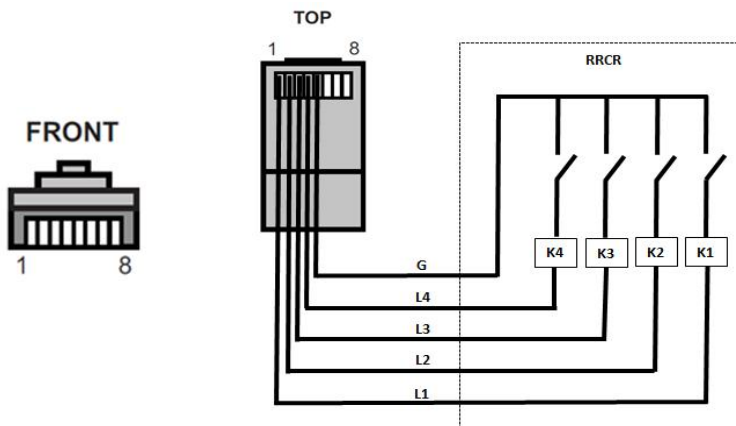


Table 4-6 Function description of the terminal

Pin NO.	Pin name	Description	Connected to (RRCR)
1	L1	Relay contact 1 input	K1 - Relay 1 output
2	L2	Relay contact 2 input	K2 - Relay 2 output
3	L3	Relay contact 3 input	K3 - Relay 3 output
4	L4	Relay contact 4 input	K4 - Relay 4 output
5	G	GND	Relays common node
6	NC	Not Connected	Not Connected
7	NC	Not Connected	Not Connected
8	NC	Not Connected	Not Connected

Table 4-7 The inverter is preconfigured to the following RRCR power levels

Relay status: close is 1, open is 0

L1	L2	L3	L4	Active Power	Cos( $\varphi$ )
1	0	0	0	0%	1
0	1	0	0	30%	1
0	0	1	0	60%	1
0	0	0	1	100%	1

(c) Logic interface for EN50549-1:2019, is in order to cease active power output within five seconds following an instruction being received at the input interface.

Figure 4-22 Inverter – RRCR Connection

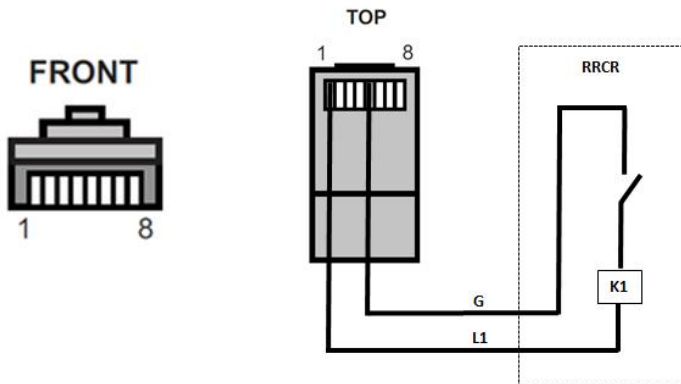


Table 4-8 Function description of the terminal

Pin NO.	Pin name	Description	Connected to (RRCR)
1	L1	Relay contact 1 input	K1 - Relay 1 output
2	NC	Not Connected	Not Connected
3	NC	Not Connected	Not Connected
4	NC	Not Connected	Not Connected
5	G	GND	K1 - Relay 1 output
6	NC	Not Connected	Not Connected
7	NC	Not Connected	Not Connected
8	NC	Not Connected	Not Connected

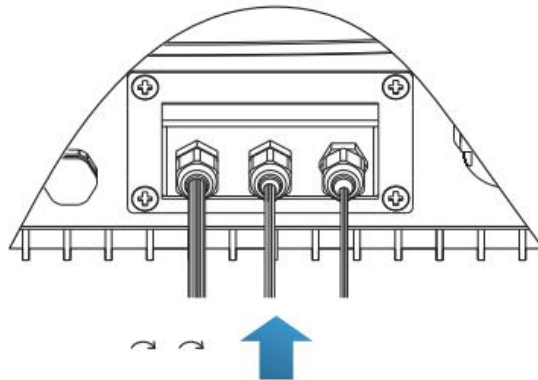
Table 4-9 The inverter is preconfigured to the following RRCR power levels.

Relay status: close is 1, open is 0

L1	Active Power	Power drop rate	Cos( $\varphi$ )
1	0%	<5 seconds	1
0	100%	/	1

**Step4** Insert the terminal as per the printed label, and then tighten the screws to fix the waterproof cover, rotate the cable gland clockwise to fasten it securely.

Figure 4-23



## 4.6. WIFI/Ethernet module installation

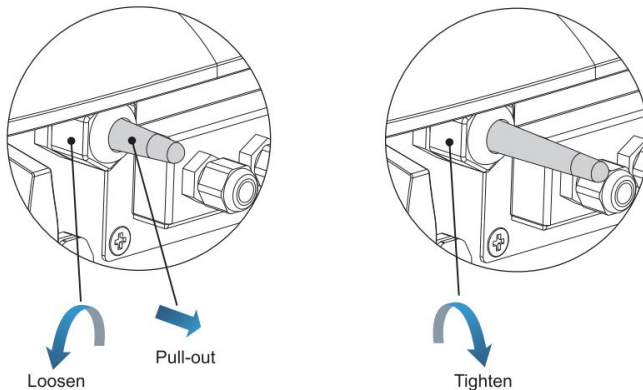
Customer can enhance the Wi-Fi signal in order to make the data transmission more stably using the method shown below:

**Step 1** Loosen the cable gland of Wi-Fi antenna;

**Step 2** Pull-out the Wi-Fi antenna from the cable gland about 50~60mm length;

**Step 3** Tighten the cable gland of Wi-Fi antenna.

Figure 4-24



## 4.7. Communication method

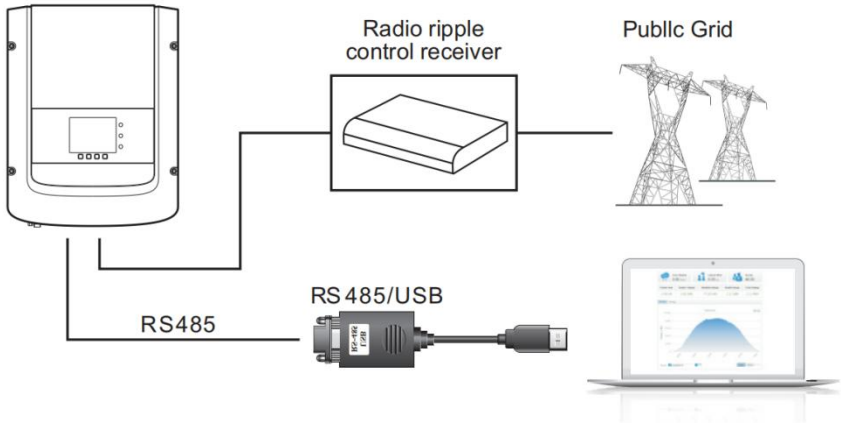
SOFAR 1.1K~3KTL grid-connected inverters offer RS485 (standard) and Wi-Fi (optional) communication modes:

### A. Communication between one inverter and one PC:

#### 1. RS485

Refer to the figure shown below, connect the TX+ and TX- of the inverter to the TX+ and TX- of the RS485 → USB adapter, and connect the USB port of the adapter to the computer.(NOTE1)

Figure 4-25



## 2. WI-FI

Refer to the figure shown below: (wireless function required for the PC).(NOTE4)

Figure 4-26



The operation information (generated energy, alert, operation status) of the inverter can be transferred to PC or uploaded to the server via Wi-Fi. You can register on the website.

[http://www.solarmanpv.com/portal/Register/Regi\\_Pub.aspx](http://www.solarmanpv.com/portal/Register/Regi_Pub.aspx)

Using the Wi-Fi S/N number(NOTE3), then you can login the website:

<http://www.solarmanpv.com/portal/LoginPage.aspx> to remote monitors the inverter.

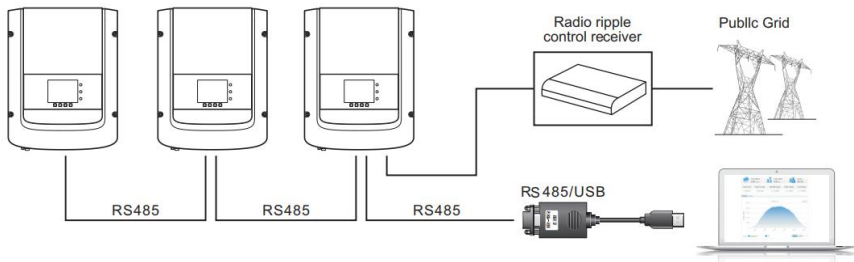
### **B. Communication between multiple inverters and one PC:**



## 1. RS485

Refer to the following figure: RS485 wires are connected in parallel between inverters, refer to section 4.5 of this manual for wire connection methods. Connect the TX+ and TX- of the inverter to the TX+ and TX- of the RS485→USB adapter; connect the USB port of the adapter to the computer. A maximum of 31 inverters can be connected in one daisy chain.(NOTE2)

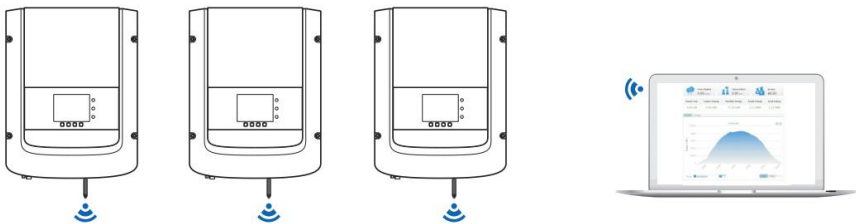
Figure 4-27



## 2. WI-FI

Refer to the figure shown below: (wireless function required for the PC).(NOTE4)

Figure 4-28



The operation information (generated energy, alert, operation status) of the inverter can be transferred to PC or uploaded to the server via Wi-Fi. You can register on the website.

[http://www.solarmanpv.com/portal/Register/Regi\\_Pub.aspx](http://www.solarmanpv.com/portal/Register/Regi_Pub.aspx)

Using the Wi-Fi S/N number(NOTE3), then you can login the website:

<http://www.solarmanpv.com/portal/LoginPage.aspx> to remote monitors the inverter.

**Note1:**

The length of the RS485 communication cable should be less than 1000 m.

**Note2:**


When multiple inverters are connected via RS485 wires, set mod-bus address to differentiate the inverters.

**Note3:**

S/N number of the Wi-Fi module is located on the side.

## 5. Commissioning of inverter

### 5.1. Safety inspection before commissioning

	Ensure that DC and AC voltages are within the acceptable range of the inverter.
Attention	

### 5.2. Start inverter

**Step 1:** Turn ON the DC switch.(optional)

**Step 2:** Turn ON the AC circuit breaker.

When the DC power generated by the solar array is adequate, the SOFAR 1.1K~3KTL inverter will start automatically. Screen showing “normal” indicates correct operation.

**NOTE:** Choose the correct country code. (refer to section 6.3 of this manual)

**Notice:** Different distribution network operators in different countries have different requirements regarding grid connections of PV grid connected inverters.

Therefore, it's very important to make sure that you have selected the correct country code according to requirements of local authority. Please consult qualified electrical engineer or personnel from electrical safety authorities about this.

Shenzhen SOFARSOLAR Co., Ltd. is not responsible for any consequences arising out of incorrect country code selection.

If the inverter indicates any fault, please refer to Section 7.1 of this manual — — trouble shooting for help.

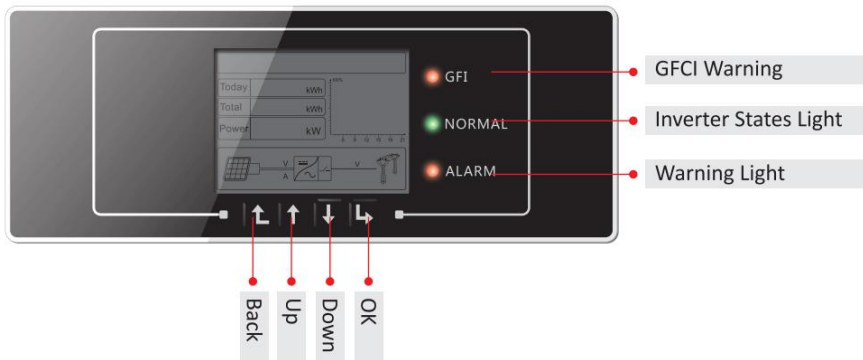
## 6. Operation interface

### Outlines of this chapter


This section introduces the display, operation, buttons and LED indicator lights of SOFAR 1.1K~3KTL Inverter.




### 6.1. Operation and Display Panel

#### Buttons and Indicator lights



#### Key-button:

• Back : to return to previous menu or enter into main menu from the standard interface.

- Up : to move up or increase value
- Down : to move down or decrease value
- OK : to confirm selection

#### Indicator Lights:

- Inverter States Light(GREEN)

Flashing: 'Wait' or 'Check' state

ON: 'Normal' state

OFF: 'Fault' or 'Permanent' state

- Warning Light (RED)

ON: 'Fault' or 'Permanent' state

OFF: 'Normal' state

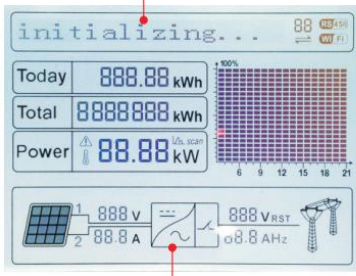
- GFCI Warning Light (RED)

ON: 'ID12: GFCI Fault' or 'ID20: GFCI Device Fault'

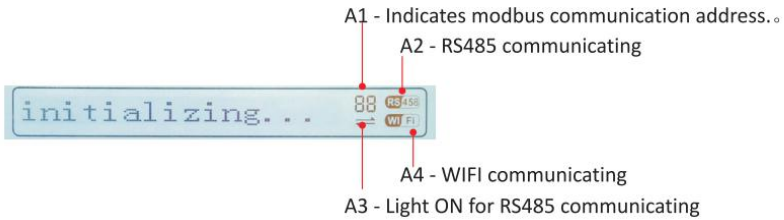
OFF: GFCI normal

## 6.2. Standard Interface

LCD standard interface is used to display inverter states, information and parameter setting etc.



LCD displays the updates of inverter energy, power, input information, warning information etc



- A5 - Light flashes to warn over frequency and power derating. Light ON to warn remote derating
- A6 - Indicates today's energy
- A7 - Indicates the total energy

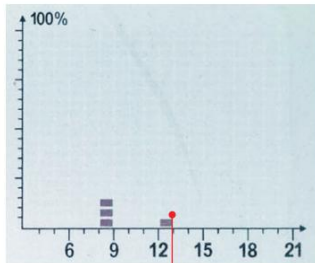


- A10 - MPPT SCAN function is activated (not available)
- A9 - Indicates real time output power
- A8 - Light ON warning for inverter high temperature

- A11 - Light ON when input voltage over 100V
- A12 - Indicates real time input voltage and current channel
- A13 - Indicates the input voltage and current of phase 1&2 and displays in turns in every three seconds
- A14 - Light ON when the state is normal



- A16 - Indicates grid current or frequency and displays in turns in every three seconds
- A15 - Indicates grid voltage



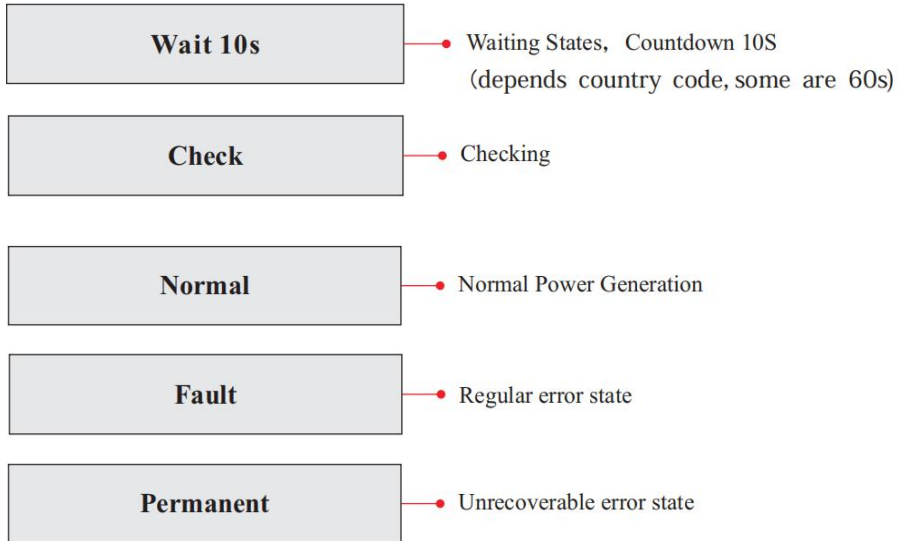
- A17 - Indicates the energy from 3:00am-21:00pm in the day

When power-on, LCD interface displays INITIALIZING, refer below picture.



when control board successfully connected with communication board, the

LCD display the current state of the inverter, display as shown in the figure below.



Inverter states includes: wait、check、normal、fault and permanent

**Wait:**Inverter is waiting to Check State at the end of reconnection time. In this state, grid voltage value is between the max and min limits and so on; If not, Inverter will go to Fault State or Permanent State.

**Check:** Inverter is checking isolation resistor, relays, and other safety requirements. It also does self-test to ensure inverter software and hardware are functional. Inverter will go to Fault State or Permanent State if any error or fault occurs.

**Normal:** Inverter enter to Normal State, it is feeding power to the grid; inverter will go to Fault State or Permanent state if any error or fault occurs.

**Fault:**Fault State: Inverter has encountered recoverable error. It should recover if the errors disappear. If Fault State continues; please check the inverter according error code.

**Permanent:**Inverter has encountered unrecoverable error, we need maintainer debug this kind of error according to error code.

When the control board and communication board connection fails, the LCD display interface as shown in the figure below.



### 6.3. Main Interface

<b>Normal</b>	-----Press "back"
	<b>1.Enter Setting</b>
	<b>2.Event List</b>
	<b>3.SystemInfo</b>
	<b>4.Display Time</b>
	<b>5.Software Update</b>

(A) "Enter Setting" Interface as below:

<b>1.Enter Setting</b>	-----Press "back"	
	<b>1.Set time</b>	<b>12. Safety Voltage</b>
	<b>2.Clear Energy</b>	<b>13.Safety Frequency</b>
	<b>3.Clear Events</b>	<b>14.Insulation Resistance</b>
	<b>4.Set Country</b>	<b>15.Relay Test</b>
	<b>5.On-Off Control</b>	<b>16.Reactive Power</b>
	<b>6.Relay Command</b>	<b>17.Power Derate</b>
	<b>7.Enable Set Country</b>	<b>18.Reflux Power</b>
	<b>8. Set Energy</b>	<b>19.MPPT Scan</b>
	<b>9.Set Address</b>	<b>20.Logic interface</b>
	<b>10.Set Language</b>	<b>21.Set Power Ratio</b>
	<b>11.Set Start Parameter</b>	

Press "Back" to Enter the main interface of "1.Enter Setting" and press "OK" to Enter the Setting menu. You can select the content you want to set by pressing "Up" or "Down".

Note1: Some settings need to enter the password (the default password is 0001), when entering the password, press "Up" or "Down" to change the number, press "OK" to confirm the current number, and press "OK" after entering the



correct password.If "password error, try again" appears, you will need to re-enter the correct password.

### 1. Set Time

Set the system time for the inverter.

### 2. Clear Energy

Clean the inverter of the total power generation.

### 3. Clear Events

Clean up the historical events recorded in the inverter.

### 4. Set Country

Set up the safety regulation country that meets the current use conditions and requirements. Before setting this item, ensure that the “Enable Set Country” option are enabled . Please refer to “7.enable Set Country” for details.

Table6-1 country code setting

code	country	code	country	code	country
00	Germany VDE AR-N4105	16	UK-G83	32	CEI0-21 In Areti
01	CEI0-21 Internal	17	Greece island	33	Ukraine
02	Australia	18	EU EN50438	34	Brazil
03	Spain RD1699	19	IEC EN61727	35	Mexico
04	Tuekey	20	Korea	36	FAR Arrete23
05	Denmark	21	Sweden	37	Denmark Tr322
06	Greece Continent	22	Europe General	38	Wide-Range-60 HZ
07	Netherland	23	CEI0-21 External	39	Ireland EN504
08	Belgium	24	Cyprus	40	Thailand PEA
09	UK-G59t	25	India	41	Thailand MEA
10	China	26	Philippines	42	LV-Range-50HZ
11	France	27	NewZealand	43	EU EN50549
12	Poland	28	Brazil	44	South Africa
13	Germany BDEW	29	Slovakia VSD	45-49	Reserved
14	Germany VDE 0126	30	Slovakia SSE		
15	Italy CEI0-16	31	Slovakia ZSD		

## 5. On-Off Control

Inverter on-off local control.

## 6. Relay Command

Dry contact command, only suitable for models with dry contacts.

<b>6. Relay Command</b>	
	<b>1. Production</b>
	<b>2. Alarm</b>
	<b>3. Alarm(alarmconfig)</b>
	<b>4. Relay Disable</b>

Relay Command Definition:

Production	The relay switches whenever a connection to (and therefore a disconnection from) the grid occurs. If the relay contractor is in normally open (close) mode, the contact will stay open (or closed) until the inverter is connected to the grid; once the inverter connects to the grid and starts to export power, the relay switches state and therefore closes (or opens). When the inverter disconnects from the grid, the relay contact returns to its position of rest, namely open (or closed).
Alarm	The relay switches whenever there is an alarm on the inverter (Error). No switching occurs when there is a Warning. If the relay contractor is in normally open(close) mode, the contact will stay open (or closed) until the inverter reports an error; once the inverter reports an error, the relay switches state and therefore closes (or opens). The contact remains switched from its rest condition until normal operation is restored.
Alarm(alarm config)	The relay switches whenever there is an alarm (Error) or a Warning, which have been previously selected by the user through the PC. the contact will stay open (or closed) until the inverter reports an error or a warning out of those selected from the menu; once the inverter displays an error or a warning out of those selected, the relay switches state and therefore closes (or opens) the contact. The relay remains switched from its rest condition until the alarm or warning has disappeared.
Relay Disable	Control function is forbidden.

## 7. Enable Set Country

Enable this option before setting the country.

Attention: when inverter working for power generation over 24h, country

setting is forbidden, it can only be set after LCD setting. Key in passwords for country setting through LCD (default: 0001), country setting can be set in 24h after keying in the correct passwords, over 24h, set through LCD again.

## **8. Set Energy**

Set the total power generation. You can modify the total power generation through this option.

## **9. Set address**

Set the address (when you need to monitor multiple inverters simultaneously), Default 01.

## **10. Set Language**

Set the inverter display language.

## **11. Set Start Parameter**

## **12. Set Safety Voltage**

## **13. Set Safety Frequency**

## **14. Insulation Resistance**

User can modify the above 4 parameters of the machine through the SD card, and the user needs to copy the parameter information that needs to be modified into the SD card in advance.

Note: To enable this feature, please contact the Sofarsolar technical support .

## **15. Relay Test**

Dry contact test, only suitable for models with dry contacts.

## **16. Reactive Power**

Enable or disable reactive functions.

## **17. Power Derate**

Enable or disable the power derate function of the inverter, and set the derate ratio.

## **18. Reflux Power**

Enable or disable the anti-reflux function of the inverter, and set the reflux power. This function needs to be used with external CT, please refer to this manual

4.5 RS485, CT, inverter logic interface connection for details.

**19. MPPT Scan**

Shadow scanning, when the component is blocked or abnormal, causing multiple power peaks, by enabling this function, the peak point of maximum power can be tracked.

**20. Logic interface**

Enable or disable logical interfaces. Please refer to this manual 4.5 RS485, CT, inverter logic interface connection for details.

**21. Set Power Ratio (The country is set at 10)**

Set generation ratio.

**(B) “Event List” Interface as below:**

Event List is used to display the real-time event records, including the total number of events and each specific ID No. and happening time. User can enter Event List interface through main interface to check details of real-time event records, Event will be listed by the happening time, and recent events will be listed in the front. Please refer to below picture. Press “Back” and “Down” to turn the page in standard interface, then enter into “2.Event List” interface.

2. Event List	
1. Current event	2. History event
Fault information	01 ID04 06150825 ( Display the event sequence number, event ID number, and event occurrence time )

**(C) “SystemInfo” Interface as below**

<b>3.SystemInfo</b>	-----Press “OK”	
	<b>1.Inverter Type</b>	<b>7.Power Factor</b>
	<b>2.Serial Number</b>	<b>8.Reflux Power</b>
	<b>3.Soft Version</b>	<b>9.Safety Paras</b>
	<b>4.Hard Version</b>	<b>10.MPPT Scan</b>
	<b>5.Country</b>	<b>11.Power Ratio</b>
	<b>6.Relay Command</b>	

The user enters the main menu by pressing "Back", turns the page to select menu contents, and presses "OK" to enter "3. SystemInfo". Turning the page up and down can select the system information to view.

### (D) Display Time

Press the "Back" button and "Up" button or "Down" key in the standard user interface to enter into "4.System Time",then press "OK" button to display the current system time.

### (E) Software Update

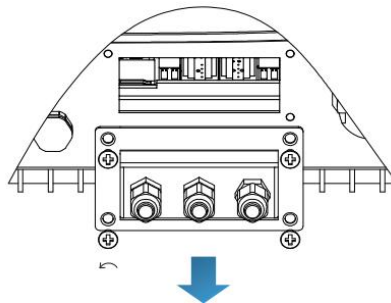
User can update software by SD card , Sofarsolar will provide the new update software called firmware for user if it is necessary,The user needs to copy the upgrade file to the SD card.

## 6.4. Update Software online

SOFAR 1.1K~3KTL inverters offer software upgrade via SD card to maximize inverter performance and avoid inverter operation error caused by software bugs.

**Step 1** First,turn off the DC and AC breaker,and then remove the communication waterproof cover as the following picture.If the RS485 line has been connected,Be sure to release the waterproof nut,Make sure the communication line is no longer the force. Then remove the waterproof cover,In order to avoid loosening the communication plug which has been connected.

Figure 6-1



**Step 2** Insert the SD card into the computer.

**Step 3** SOFAR SOLAR will send the Software code to the user who needs to update. After user receive the file,please decompressing file and cover the original file in SD card.

**Step 4** Insert the SD card into the SD card interface.

**Step 5** Then turn on DC switch and enter into the online upgrade to the main menu"5.Software Update"in the LCD display program[6.3(E)].The method to enter the menu can refer to operation interface of LCD.

**Step 6** Input the password,if password is correct,and then begin the update process,the original password is 0715.

**Step 7** System update main DSP, slave DSP and ARM in turns.If main DSP update success,the LCD will display"Update DSP1 Success", otherwise display "Update DSP1 Fail";If slave DSP update success,the LCD will display"Update DSP2 Success",otherwise display "UpdateDSP2 Fail".

**Step 8** If Fail,please turn off the DC breaker,wait for the LCD screen extinguish,then turn on the DC breaker again,then Continue to update from step 5.

**Step 9** After the update is completed,turn off the DC breaker, wait for the LCD screen extinguish,then recover the communication waterproof and then turn on the DC breaker and AC breaker again,the inverter will enters the running state. User can check the current software version in SystemInfo>>>3.SoftVersion.

## 7. *Trouble shooting*

### Outlines of this chapter

This topic describes how to perform daily maintenance and troubleshooting to ensure long term proper operation of the inverter.

### 7.1. Trouble shooting

This section contains information and procedures for solving possible problems with the inverter.

- This section help users to identify the inverter fault. Please read the following procedures carefully:
- ✧ Check the warning, fault messages or fault codes shown on the inverter screen, record all the fault information.
- ✧ If there is no fault information shown on the screen, check whether the following requirements are met:
  - Is the inverter mounted in a clean, dry place with good ventilation?
  - Is the DC switch turned ON?
  - Are the cables adequately sized and short enough?
  - Are the input and output connections and wiring in good condition?
  - Are the configuration settings correct for the particular installation?
  - Are the display panel and the communication cables properly connected and undamaged?
- Follow the steps below to view recorded problems: Press "Back" to enter the main menu in the normal interface. In the interface screen select "Event List", then press "OK" to enter events.

Table 7-1 Event list

Event List NO.	Event List Name	Event List description	solution
ID01	GridOVP	The power grid voltage is too high	If the alarm occurs occasionally, the possible cause is that the electric grid is abnormal occasionally. inverter automatically returns to normal operating status when the electric grid's back to normal. If the alarm occurs frequently, check whether the grid voltage/frequency is within the acceptable range. If no, contact technical support. If yes, check the AC circuit breaker and AC wiring of the inverter.
ID02	GridUVP	The power grid voltage is too low	
ID03	GridOFP	The power grid frequency is too high	
ID04	GridUFP	The power grid frequency is too low	If the grid voltage/frequency is within the acceptable range and AC wiring is correct, while the alarm occurs repeatedly, contact technical support to change the grid over-voltage, under-voltage, overfrequency, under-frequency protection points after obtaining approval from the local electrical grid operator.
ID05	PVUVP	The input voltage is too low	Check whether too few PV modules are series connected in a PV string, thus the voltage( $V_{mp}$ ) of the PV string is lower than the minimum operating voltage of inverter. If yes, adjust the number of series connected PV modules to increase the voltage of the PV string to fit the input voltage range of inverter. inverter automatically returns to normal operating status after correct adjustments.
ID09	PVOVP	The input voltage is too high	Check whether too many PV modules are series connected in a PV string, thus the voltage( $V_{oc}$ ) of the PV string is higher than the maximum input voltage of inverter. If yes, adjust the number of series connected PV modules to decrease the voltage of the PV string to fit the input voltage range of inverter. inverter automatically returns to normal operating status after correct adjustments.
ID10	IpvUnbalance	Input current is not balanced	Check the input mode(parallel mode/ independent mode) setting of inverter according to Section 6.3 (C) 6.Input Mode
ID11	PvConfigSetW	Incorrect input	



	rong	mode	
			of this user manual, If it's incorrect, change it according to Section 6.3 (A) 10.Set Input mode of this manual.
ID12	GFCIFault	GFCI Fault	If the fault occurs occasionally, the possible cause is that the external circuits are abnormal occasionally. inverter automatically returns to normal operating status after the fault is rectified.If the fault occurs frequently and lasts a long time,check whether the insulation resistance between the PV array and earth(ground) is too low, then check the insulation conditions of PV cable.
ID14	HwBoostOCP	The input current is too high , and has happen hardware protection	Check whether the input current is higher than the maximum input current of inverters, then check the input wiring, if both are correct, please contact technical support.
ID15	HwAcOCP	The grid current is too high , and has happen hardware protection	ID15-ID24 are internal faults of inverter, turn OFF the “DC switch”, wait for 5 minutes, then turn ON the “DC switch”. Check whether the fault is rectified. If no, please contact technical support.
ID16	AcRmsOCP	The grid current is too high	
ID17	HwADFaultIGrid	The grid current sampling error	
ID18	HwADFaultDCI	The DCI sampling error	
ID19	HwADFaultVGrid	The grid voltage sampling error	
ID20	GFCIDeviceFault	The GFCI sampling error	
ID21	MChip_Fault	The master chip fault	
ID22	HwAuxPower Fault	The auxiliary voltage error	
ID23	BusVoltZeroFault	The bus voltage sampling error	
ID24	IacRmsUnbalance	The Output current is not balanced	
ID25	BusUVP	The bus voltage Is too low	If the PV array configuration is correct (no ID05 fault), the possible cause is that the solar irradiance is too low. inverter

			automatically returns to normal operating status after the solar irradiance returns to normal level.
ID26	BusOVP	The bus voltage Is too high	ID26-ID27 are internal faults of inverter, turn OFF the “DC switch”, wait for 5 minutes, then turn ON the “DC switch”. Check whether the fault is rectified. If no, please contact technical support.
ID27	VbusUnbalan	The bus voltage is not balanced	
ID28	DciOCP	The Dci is too high	Check the input mode(parallel mode/ independent mode) setting of inverter according to Section 6.3 (C) 6.Input Mode of this user manual, If it’s incorrect, change it according to Section 6.3 (A) 10.Set Input mode of this manual. If the input mode is correct, turn OFF the “DC switch”, wait for 5 minutes, then turn ON the “DC switch”. Check whether the fault is rectified. If no, please contact technical support, If it’s incorrect, change it according to Section 6.3 (A) 10.Set Input mode of this manual.
ID29	SwOCPInstan	The grid current is too high	Internal faults of inverter, turn OFF the “DC switch”, wait for 5 minutes, then turn ON the “DC switch”. Check whether the fault is rectified. If no, please contact technical support.
ID30	SwBOCPInstan	The input current is too high	Check whether the input current is higher than the maximum input current of inverters, then check the input wiring, if both are correct, please contact technical support.
ID49	ConsistentFault_VGrid	The grid voltage sampling value between the master DSP and slave DSP is not consistent	ID49-ID55 are internal faults of inverter, turn OFF the “DC switch”, wait for 5 minutes, then turn ON the “DC switch”.Check whether the fault is rectified. If no, please contact technical support.
ID50	ConsistentFault_FGrid	The grid frequency sampling value between the master DSP and slave DSP is not consistent	

ID51	ConsistentFault_DC1	The DC1 sampling value between the master DSP and slave DSP is not consistent	
ID52	ConsistentFault_GFC1	The GFC1 sampling value between the master DSP and slave DSP is not consistent	
ID53	SpiCommLose	The spi communication between the master DSP and slave DSP is fault	
ID54	SciCommLose	The Sci communication between the control board communication board is fault	
ID55	RelayTestFail	The relays fault	
ID56	PvIsoFault	The insulation resistance is too low	Check the insulation resistance between the PV array and earth(ground), if a short circuit occurs, rectify the fault.
ID57	OverTempFault_Inv	The inverter temp is too high	Ensure the installation position and installation method meet the requirements of Section 3.4 of this user manual. Check whether the ambient temperature of the installation position exceeds the upper limit. If yes, improve ventilation to decrease the temperature.
ID58	OverTempFault_Boost	The Boost temp is too high	
ID59	OverTempFault_Env	The environment temp is too high	
ID65	UnrecoverHw_AcOCP	The grid current is too high,and has cause unrecoverable hardware fault	ID65-ID70 are internal faults of inverter, turn OFF the “DC switch”, wait for 5 minutes, then turn ON the “DC switch”. Check whether the fault is rectified. If no, please contact technical support.
ID66	UnrecoverBus_OVP	The bus voltage is too high,and has cause unrecoverable	

		fault	
ID67	UnrecoverIacRmsUnbalance	The grid current is unbalance,and has cause unrecoverable fault	
ID68	UnrecoverIpvUnbalance	The input current is unbalance,and has cause unrecoverable fault	
ID69	UnrecoverVbusUnbalance	The bus voltage is unbalance,and has cause unrecoverable fault	
ID70	Unrecover OCP Instant	The grid current is too high,and has cause unrecoverable fault	
ID71	UnrecoverPvConfigSetWrong	Incorrect input mode	Check the input mode(parallel mode/independent mode) setting of inverter according to Section 6.3 (C) 6.Input Mode of this user manual, If it's incorrect, change it according to Section 6.3 (A) 10.Set Input mode of this manual
ID74	UnrecoverIPVINstant	The input current is too high,and has cause unrecoverable fault	ID74-ID77 are internal faults of inverter, turn OFF the "DC switch", wait for 5 minutes, then turn ON the "DC switch". Check whether the fault is rectified. If no, please contact technical support.
ID75	UnrecoverWRITEEPROM	The EEPROM is unrecoverable	
ID76	UnrecoverREADEEPROM	The EEPROM is unrecoverable	
ID77	Unrecover Relay Fail	Relay has happen permanent fault	
ID81	Over Temp Derating	The inverter has derated because of the temperature is too high	Ensure the installation position and installation method meet the requirements of Section 3.4 of this user manual.Check whether the ambient temperature of the installation position exceeds the upper limit. If yes, improve ventilation to

			decrease the temperature.
ID82	Over Freq Derating	The inverter has derated because of the grid frequency is too high	Inverter automatically reduce the output power when the frequency of electrical grid is too high.
ID83	Remote Derating	The inverter has derated by the Remote control	Inverter records ID83 in case of remote power derating operation. Check the wiring of remote input and output control signal port on the communication board according to Section 4.5 of this user manual.
ID84	Remote Off	The inverter has shut down because by the Remote control	Inverter records ID84 in case of remote shutdown operation. Check the wiring of remote input and output control signal port on the communication board according to Section 4.5 of this user manual.
ID94	Software version is not consistent	The software between the control board and the communication board is not consistent	Contact technical support to upgrade software.
ID95	Communication board EEPROM fault	The communication board EEPROM is fault	ID95~ID96 are internal faults of inverter, turn OFF the “DC switch”, wait for 5 minutes, then turn ON the “DC switch”. Check whether the fault is rectified. If no, please contact technical support.
ID96	RTC clock chip anomaly	RTC clock chip is fault	
ID97	Invalid Country	The country is invalid	Check the country setting according to Section 6.3 (C) 5. Country of this user manual, If it's incorrect, change it according to Section 6.3 (A) 4. Set Country Code of this manual.
ID98	SD fault	The SD card is fault	Please replace the SD card.

## 7.2. Maintenance

Inverters generally do not need any daily or routine maintenance. Heat sink

should not be blocked by dust, dirt or any other items. Before the cleaning, make sure that the DC SWITCH is turned OFF and the circuit breaker between inverter and electrical grid is turned OFF. Wait at least for 5 minutes before the Cleaning.

✧ **Inverter cleaning**

Please clean the inverter with an air blower, a dry & soft cloth or a soft bristle brush. Do NOT clean the inverter with water, corrosive chemicals, detergent, etc.

✧ **Heat sink cleaning**

For the long-term proper operation of inverters, ensure there is enough space around the heat sink for ventilation, check the heat sink for blockage (dust, snow, etc.) and clean them if they exist. Please clean the heat sink with an air blower, a dry & soft cloth or a soft bristle brush. Do NOT clean the heat sink with water, corrosive chemicals, detergent, etc.

## 8. Technical data

### Outlines of this chapter

This topic lists the technical specifications for all SOFAR 1.1K~3KTL inverters.

### 8.1. Input parameters (DC)

Technical Data	SOFAR 1100TL	SOFAR 1600TL	SOFAR 2200TL	SOFAR 2700TL	SOFAR 3000TL
Max.DC power	1200W	1800W	2400W	2900W	3300W
Max.Input voltage	450V			500V	
Start-up input voltage	100V			120V	
MPPT voltage range	90-450V			100-500V	
Rated input voltage	360V				
Full load DC voltage range	110-450V	165-450V	170-500V	500-500V	200-500V
Max. Input current	10A			12A	
Input short circuit current	13A			15A	
Number of MPPT/ Number of DC input	1/1				

## 8.2. Output parameters (AC)

Technical Data	SOFAR 1100TL	SOFAR 1600TL	SOFAR 2200TL	SOFAR 2700TL	SOFAR 3000TL
Rated Output power	1000W	1550W	2100W	2600W	3000W
Max.Output power	1000VA	1550VA	2100VA	2600VA	3000VA
Max.Output current	4.5A	7A	9.5A	11.5A	13A
Nominal grid voltage	230Vac / single phase				
Grid voltage range	180-270Vac( According to local grid standard )				
Nominal grid frequency	50Hz/60Hz				
Grid frequency range	45~53Hz/57~63Hz( According to local grid standard )				
THDi	<3%				
Power factor	1 default( +/-0.8 adjustable)				



## 8.3. Efficiency, Protection and Communication

Technical Data	SOFAR 1100TL	SOFAR 1600TL	SOFAR 2200TL	SOFAR 2700TL	SOFAR 3000TL
Max.Efficiency	97.0%	97.0%	97.0%	97.1%	97.2%
Euro Efficiency	95.2%	95.9%	96.1%	96.4%	96.5%
MPPT Efficiency	>99.9%				
Self-consumption at night	<1W				
Safety protection	Anti islanding,RCMU,Ground fault monitoring				
Certification	AS/NZS 4777, VDE V 0124-100, VDE V 0126-1-1, VDE-AR-N4105, CE10-21, EN 50438/EN50549, G83/G98, C10/11 , RD1699, UTE C15-712-1;ABNT NBR 16149/16150(for SOFAR3KTL)				
Protective class	Class I				
External environment pollution degree	Degree 3				
Overvoltage category	PV:OVC II, AC mains:OVC III				
Max inverter Back-feed current to the array	0A				
Output short circuit current to the array	200A/1us				
Output inrush current and duration	0.8A/2us				

## 8.4. General Date

Technical Data	SOFAR 1100TL	SOFAR 1600TL	SOFAR 2200TL	SOFAR 2700TL	SOFAR 3000TL
Topology	Transformerless				
Ambient temperature range	-30~60℃				
Permissible humidity range	0~100%				
Noise figure	<25dB				
DC Switch	Optional				
Cooling	Natural convection				
Max.Operating altitude	2000m				
Outline Dimension	405*314*135mm				
Bracket	Wall-mounted				
Weight	11kg		12kg		
Communication mode	RS485.WiFi/GPRS(optional)				
Degree of protection	IP65				

## *9. Quality Assurance*

### **Standard warranty period**

The standard warranty period of inverter is 60 months (5 years). There are two calculation methods for the warranty period:

1. Purchase invoice provided by the customer: the first flight provides a standard warranty period of 60 months (5 years) from the invoice date;
2. The customer fails to provide the invoice: from the production date (according to the SN number of the machine), Our company provides a warranty period of 63 months (5.25 years).
3. In case of any special warranty agreement, the purchase agreement shall prevail.

### **Extended warranty period**

Within 12 months of the purchase of the inverter (based on the purchase invoice) or within 24 months of the production of the inverter (SN number of machine, based on the first date of arrival), Customers can apply to buy extended warranty products from the company's sales team by providing the product serial number, Our company may refuse to do not conform to the time limit extended warranty purchase application. Customers can buy an extended warranty of 5, 10, 15 years.

If the customer wants to apply for the extended warranty service, please contact the sales team of our company. to purchase the products that are beyond the purchase period of extended warranty but have not yet passed the standard quality warranty period. Customers shall bear different extended premium.

During the extended warranty period, pv components GPRS, WIFI and

lightning protection devices are not included in the extended warranty period. If they fail during the extended warranty period, customers need to purchase and replace them from the our company.

Once the extended warranty service is purchased, our company will issue the extended warranty card to the customer to confirm the extended warranty period.

## **Invalid warranty clause**

Equipment failure caused by the following reasons is not covered by the warranty:

- 1) The "warranty card" has not been sent to the distributor or our company;
- 2) Without the consent of our company to change equipment or replace parts;
- 3) Use unqualified materials to support our company 's products, resulting in product failure;
- 4) Technicians of non-company modify or attempt to repair and erase the product serial number or silk screen;
- 5) Incorrect installation, debugging and use methods;
- 6) Failure to comply with safety regulations (certification standards, etc.);
- 7) Damage caused by improper storage by dealers or end users;
- 8) Transportation damage (including scratches caused by internal packaging during transportation).Please claim directly from the transportation company or insurance company as soon as possible and obtain damage identification such as container/package unloading;
- 9) Failure to follow the product user manual, installation manual and maintenance guidelines;
- 10) Improper use or misuse of the device;
- 11) Poor ventilation of the device;
- 12) The product maintenance process does not follow relevant standards;
- 13) Failure or damage caused by natural disasters or other force majeure (such as earthquake, lightning strike, fire, etc.)



Product Name: PV Grid-Connected Inverter  
Company Name: Shenzhen SOFARSOLAR Co., Ltd.  
ADD: 401, Building 4, AnTongDa Industrial Park, District 68, XingDong Community,  
XinAn Street, BaoAn District, Shenzhen, Guangdong.P.R. China  
Email: [service@sofarsolar.com](mailto:service@sofarsolar.com)  
Tel: 0510-6690 2300  
Web: [www.sofarsolar.com](http://www.sofarsolar.com)

301.0000062-2