

# Stick Logger (Ethernet) Quick Guide

Model:LSE-3

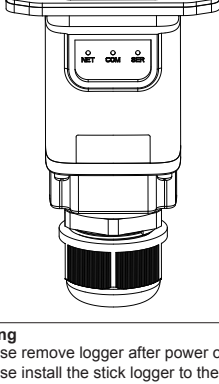

## Warning

1. Please remove logger after power off.
2. Please install the stick logger to the inverter after the cables installed.
3. To guarantee communication quality, please use shielded twisted pair or above. Meanwhile, the maximum communication distance cannot exceed 100m.



## Notice:

Please read this manual carefully before using products and keep it in the place where O&M providers can easily find.

Due to product upgrade and other factors, the content of this manual might change from time to time. Please take actual product as standard and get latest manual from [www.solarman.cn](http://www.solarman.cn) or sales. Unless otherwise agreed herein, this manual will only be used as guidance. Any statement, information or suggestion in this manual will not take any form of responsibility.

Without written permission, any content of this document (partly or entirely) cannot be extracted, copied or transmitted in any form by any company or individual.

## Product List

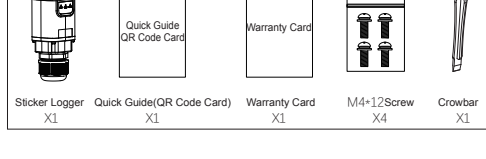

## 1. Stick Logger Net Interface Installation

**Step1:** Please remove waterproof cap, waterproof inner core, waterproof joint body in order. Please do not lose waterproofing ring.

**Step2:** Cover network line with waterproof cap, waterproof inner core, waterproof joint body and waterproofing ring in order (Force to open waterproofing inner core.)

**Step3:** Insert RJ45 into Stick Logger's interface. Tighten waterproof joint body and waterproof cap in order. Prevent network line loosening during the tightening process.

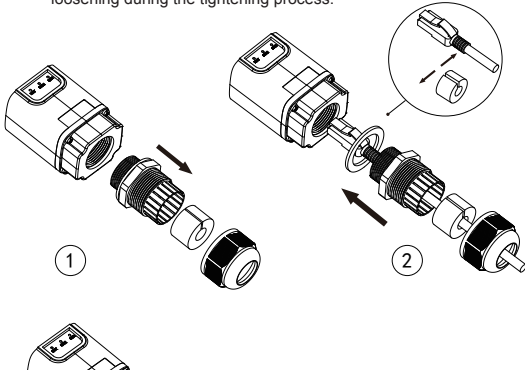

## 2. Stick Logger Installation

**Step1:** Assemble logger to the inverter communication interface as shown in the diagram.



According to the arrow direction

**Step2:** Install/Remove

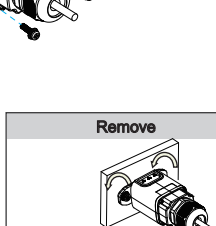
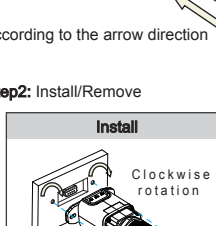

### Warning:

Please do not hold the logger body to rotate while install or remove the logger.



### Remove: Cable RegisteredJack

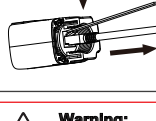

Use crowbar to press buckle of cable RegisteredJack, then draw out RegisteredJack.



### Warning:

Please put crowbar in the place where children under 12-year-old cannot touch in case of any damage.



## 3. Connect to Router

**Step1:** Connect another end of network line to LAN Interface.

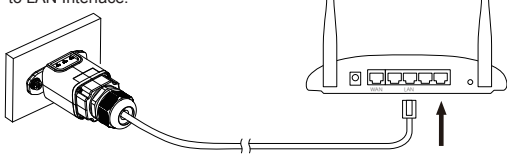

## 4. Logger Status

Check Indicator light

Lights	Implication	Status Description
NET	Communication with network	1.Light off: Connection to the network failed 2.Light on: Connection to the network succeeded
COM	Communication with inverter	1.Light off: Communication with inverter failed 2.Light on: Communication with inverter succeeded
SER	Communication with server	1.On 6s/Off 6s(Slow flash): Connection to the server failed 2.On 1s/Off 1s(Slow flash): Connection to the server succeeded

The normal operation status of the stick logger:

Please make sure the router connected to the network successfully.

1. Initialization: NET light is on lasting 1s then extinguishes.
2. Connecting to the server: SER light flashes slowly 2s later.
3. Communication with inverter succeeded: COM light keeps on around 5s.

**4.Connection to the server succeeded: SER light fast flashes and NET light keeps on around 7s. Start to run normally.**

## 5. Registration and Usage

Please download APP according to the <SOLARMAN APP USER MANUALS>. Then complete the registration of new account and plants.



## 6. Abnormal State Processing

If the data on platform is abnormal when the stick logger is running, please check the table below and according to the status of indicator lights to complete a simple troubleshooting. If it still can not be resolved or indicator lights status do not show in the table below, please contact Customer Support.

(Note: Please using the following table query after power-on for 10s at least)

NET	COM	SER	Fault Description	Fault Cause	Solution
NET	COM	SER			
Any state	OFF	Any state	Communication with inverter abnormal	1.Connection between stick logger and inverter loosen. 2.Inverter does not match with stick logger's communication rate.	1.Check the connection between stick logger and inverter. Remove the stick logger and install again. 2.Check inverter's communication rate to see if it matches with stick logger's.
OFF	Any state	Flash	Communication with server abnormal	1.The network line is not connected to the router. 2.The router cannot connect to the network. 3.Connection between stick logger's network and joint loosen.	1. Connect to router's network interface again. 2.Connect to stick logger's network interface again. 3.Check if the router connected to the network line successfully.
OFF	OFF	OFF	Power supply abnormal	1.Connection between stick logger and inverter loosen. 2.Stick Logger abnormal.	1.Check the joint, insert or extract it again. 2.Contact Customer Support