



User manual

Lithium-Ion Storage Battery

Product Model: GTX5000



Contents

1	General Information	1
1.1	Validity	1
1.2	Intended Use	1
1.3	Identifying The Product	3
2	Safety	5
3	Technical Data.....	7
4	Technical Items	9
5	Product Overview.....	11
5.1	Brief Introduction	11
5.2	Interface Introduction (Front Side)	12
5.2.1	Start Button	13
5.2.2	LED Indicator Definition	14
5.3	Interface Introduction (Left Side).....	15
5.3.1	Wiring instructions	16
5.3.2	Link Port and Automatic Coding Function.....	19
5.3.3	CAN / RS485 Port.....	20
5.3.4	RS232 Port	21
5.3.5	Output Dry Contact Terminal	21
5.3.6	Extend LCD Terminal	22
6	Installation Guide	23
6.1	Checking Before Installation	23
6.1.1	Checking Outer Packing Materials.....	23
6.1.2	Checking Deliverables	24

6.2	Tools	28
6.3	Installation requirements	28
6.3.1	Installation environment requirements	28
6.3.2	Installation carrier requirements	30
6.4	Installation Method	30
6.5	Installation Instructions	32
6.5.1	Dimensions	32
6.5.2	Single Machine Installation Step	34
6.5.3	Parallel Machine Installation Step	40
6.6	Electrical Connection	44
6.6.1	Electrical Connection Process	44
6.6.2	Single machine wiring step	44
6.6.3	Parallel machine wiring step for suspended on wall	47
6.6.4	Parallel machine wiring step for pedestal mounted	53
7	Cleaning and Maintenance	61
7.1	Cleaning	61
7.2	Maintenance	61
7.2.1	Recharge Requirements During Normal Storage	61
7.2.2	Recharge Requirements When Over Discharged	62
7.2.3	Replacement or expand capacity	63
8	Common Issues and Solutions	65
8.1	Common Issues and Solutions	65
8.2	Emergency	67

1 General Information

This manual introduces AMASSTORE GTX5000 LFP Battery Product from SOFAR. Please read this manual before you use the battery.

Any confusion, please contact SOFAR immediately for advice and clarification.

1.1 Validity

This user manual is applicable to AMASSTORE GTX5000.

This user manual contains AMASSTORE GTX5000 product information, usage guidance, safety information, installation guide and details on common operating issues and subsequent corrective actions.

1.2 Intended Use

AMASSTORE GTX5000 is an energy storage unit that is designed to be used in residential on-grid applications with the capability for short-term backup.

Notes regarding intended use:

AMASSTORE GTX5000 is not suitable for supporting life-sustaining medical

devices.

This product is intended for use only in accordance with the information provided in the enclosed documentation and with the locally applicable standards and regulations. Any other application may cause personal injury or property damage.

The illustrations in this manual are meant only to help explain system configuration concepts, includes usage guidance, safety precautions, and common operating issues and subsequent corrective actions.

Alterations to the product, e.g. changes or modifications, are only permitted with the express written permission of SOFAR. Unauthorized alterations will void warranty claims. SOFAR shall not be held liable for any damage caused by such changes. Any use of the product other than that described in the Intended Use section does not qualify as appropriate. The enclosed documentation is an integral part of this product. Keep the documentation in a convenient place for future reference and observe all instructions contained therein. The type label (see Section 1.3) must remain attached to the product.

Please contact SOFAR or local after-service providers within 1 week once the user decides to cease using their SOFAR Battery products.

1.3 Identifying The Product

The type labels were attached on the product, which contain the product identification information. For safe usage, the user must be well-informed of the contents in the type labels.

The type labels include:



**Rechargeable
Li-ion Battery**

IFpP/34/201/173/[1P16S]M/-10+50/95

Model: GTX5000

Ratings: 5120Wh/51.2V/100Ah

Charge Voltage: 56.16V

Max. Output Power: 3.5KW



AMASSTORE

Shenzhen SOFAR SOLAR Co., Ltd.





401, Building 4, AnTongDa Industrial Park, District
68, XingDong Community, XinAn Street, BaoAn
District, Shenzhen, Guangdong, P.R. China

CAUTION !

- Do not disassemble
- Do not short-circuit
- Do not place in fire or near hot source
- Please read user manual carefully

IEC 62040-1 IEC 62619 SAA201631
UN 38.3



DANGER !
CHEMICAL HAZARD &
SHOCK HAZARD

- Do not disassemble or repair by yourself.
- Do not drop, deform, impact, cut or spear with a sharp object.
- Do not place near open flame or incinerate.
- Do not put any objects onto the battery.
- Do not allow to contact with liquid.
- Keep out of reach of children, animals or insects.
- Contact the supplier within 24 hours if anything wrong.







WARNING !



Stop the battery operation immediately to secure the battery safety when environmental temperature is over working temperature (suitable operation temperature is 0~45°C).
If battery is at high temperature usually, it will impact battery performance.

2 Safety

This section contains safety information that must be observed at all times when working on or with batteries. To prevent personal injury or property damage and to ensure long-term operation of the batteries, read this section carefully and observe all safety information at all times.



WARNING

Environmental Requirement

Do not expose the battery to temperature above 50°C

Do not place the battery near any heat sources

Do not expose the battery to moisture or liquids

Do not expose the battery to corrosive gases or liquids

Do not expose the battery to direct sunlight for extended periods of time

Do not allow the battery power terminals to touch conductive objects such as wires

Place battery in secure location away from children and animals

Operation Precautions

Do not disassemble the battery

Do not touch the battery pack with wet hands

Do not crush, drop or puncture the battery

Do not reverse the polarity or connect in series

Do not short circuit the terminals, remove all jewelry items that could product a short circuit before installation and handling

Always dispose of the product according to local safety regulations

Store and recharge battery in a manner in accordance with this user manual

Ensure reliable grounding

Disconnect battery from power/load and then power off battery before installation and maintenance

When storing or handing, do not stack up batteries when outside protective package

Packaged batteries should not be stacked more than specified number stipulated on the package

Continued operation of a damaged battery can result in dangerous situation that may cause severe injury due to electrical shock.

3 Technical Data

Basic Parameters	Specification
Battery Type	LiFePO ₄ , Lithium Iron Phosphate
Nominal Capacity (Ah)	100AH
Nominal Voltage (V)	51.2Vdc
Total Energy	5120Wh
Usable Energy(90% DOD)	4600Wh
Charge Voltage (V)	55.68~56.16Vdc
Discharge Voltage (V)	45.6-56.16Vdc
Nominal Charge Current(A)	50A
MAX. Charge Current(A)	50A
MAX Charge Power(W)	2800W
Nominal Discharge Current(A)	50A
Nominal Discharge Power(W)	2560W
Max. Discharge Current(A)	75A
Max. Discharge Power(W)	3500W
Short Current(A)	350A
Communication	RS232、RS485、CAN
Working Temperature	0°C ~ 55°C
Storage Temperature	≤25°C, 12 months; ≤35°C, 6 months; ≤45°C, 3 months

Operating humidity	≤ 95%RH
Storage humidity	≤ 95%RH
Max.Operating Altitude	≤2000m
Scalable	Suggest up to 4
Enclosure Protection Rating	IP20
Net Weight(Kg)	55Kg
Dimension (mm)	480mm*211.5mm*600mm
Certification	IEC62619、UN38.3、IEC62040-1、SAA etc.
Cycle Life	6000 Cycles @ 80% DOD / 25℃ / 0.5C, 60% EOL

Note: Operating current derating according to cell voltage and battery temperature.

4 Technical Items

No.	Terms	Comment
1	Discharge	Battery output power for load
2	Charge	To put electricity into battery by charger
3	Full charge	Battery had been full charged, SOC is 100%.
4	Standby	Ready for charging or discharging
5	Shutdown	Power off
6	SOC	State of Charge(Useable capacity)
7	Battery voltage	The voltage between B+/B-
8	Cell voltage	Single cell voltage
9	Pack voltage	The voltage between P+/P-
10	Alarm	Indicate that the battery is in abnormal status
11	Protect	Battery stops charging or discharging and is recoverable
12	Fault	Battery or BMS is broken, need to be replaced
13	Over discharged	Battery is lack of electricity, and needs to be recharged in time

5 Product Overview

5.1 Brief Introduction



Product overview

AMASSTORE GTX5000 is a battery system with an operating voltage range between 45.6~56.16V. It is utilized in household energy storage applications and works together with a low-voltage PCS to realize the goal of energy storage for the home.

AMASSTORE GTX5000 has built-in BMS (battery management system), which can manage and monitor cells information including voltage, current and

temperature. What’s more, BMS can balance cells charging to extend cycle life. BMS has protection functions including over-discharge, over-charge, over-current and high/low temperature; the system can automatically manage charge state, discharge state and balance state.

Multiple batteries can connected in parallel to expand capacity and power for larger capacity and longer power supporting duration requirements, AMASSTORE GTX5000 support up to 4 parallel operation.

5.2 Interface Introduction (Front Side)

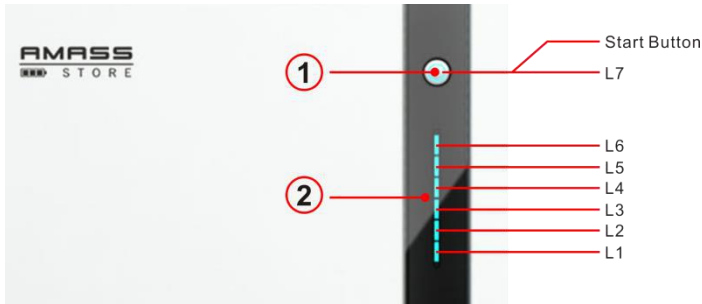

No.	Items
1	Start Button Status Indicators
2	Battery Level Indicator

5.2.1 Start Button

Start button integrated LED status Indicators, to show Battery running status or warning status.

1、 Press start button more than 3s and then release the button, LED will lights from L7 to L1, and then enters to automatic coding, all LED lights flash and L7 is shown as purple. After the automatic coding, L1 to L6 shows the normal capacity, and L7 shows the running status:

L7: Blue, long lighting when charging and flash when discharging;

L7: Red, long bright if equipment failure or protected.

2、 In parallel system, connect the parallel communication wiring according to section 5.3.1, then long press the start button of the **Master PACK**, after normal startup, the battery system will automatically encode and assign ID to each parallel PACK, and then the parallel system will run normally.

3、 Press start button of **Master PACK** more than 3s and then release the button, LED will lights from L1 to L7 to shut down the battery module. In parallel system, the master pack will shut down after all slave packs shut down.

5.2.2 LED Indicator Definition

L1 to L6: Blue, show the battery level, each light indicate 16.67% SOC.

L7: Blue or Red, show battery running status, blue is normal, red is abnormal.

LED Indicators Instructions

		RUN	ALM	Battery Level Indicator						Descriptions
Status		L7		L6	L5	L4	L3	L2	L1	
Shut down		OFF	OFF	OFF	OFF	OFF	OFF	OFF	OFF	All OFF
Standby		Flash 1	OFF	According to the battery level						Indicates Standby
Charging	Normal	Light	OFF	According to the battery level						The highest capacity indicator LED flashes (flash 2), others lighting
	Full Charged	Light	OFF	Light	Light	Light	Light	Light	Light	Turn to standby status when charger off
	Protection	OFF	Light	OFF	OFF	OFF	OFF	OFF	OFF	Stop charging
Discharging	Normal	Flash 3	OFF	According to the battery level						
	UVP	OFF	OFF	OFF	OFF	OFF	OFF	OFF	OFF	Stop discharging
	Protection	OFF	Light	OFF	OFF	OFF	OFF	OFF	OFF	Stop discharging
Fault		OFF	Light	OFF	OFF	OFF	OFF	OFF	OFF	Stop Charging and Discharging

Charging Battery Level Indicators Instructions

Status		Charging						
Battery Level Indicators		L7	L6	L5	L4	L3	L2	L1
Battery Level (%)	0~17%	Light	OFF	OFF	OFF	OFF	OFF	Flash2
	18~33%		OFF	OFF	OFF	OFF	Flash 2	Light
	34~50%		OFF	OFF	OFF	Flash 2	Light	Light
	51~66%		OFF	OFF	Flash 2	Light	Light	Light
	67~83%		OFF	Flash 2	Light	Light	Light	Light
84~100%	Flash 2		Light	Light	Light	Light	Light	

Discharging Battery Level Indicators Instructions

Status		Discharging						
Battery Level Indicators		L7	L6	L5	L4	L3	L2	L1
Battery Level (%)	0~17%	Flash 3	OFF	OFF	OFF	OFF	OFF	Light
	18~33%		OFF	OFF	OFF	OFF	Light	Light
	34~50%		OFF	OFF	OFF	Light	Light	Light
	51~66%		OFF	OFF	Light	Light	Light	Light
	67~83%		OFF	Light	Light	Light	Light	Light
	84~100%		Light	Light	Light	Light	Light	Light

Note: The flashing instructions, flash 1 - light 0.25s / off 3.75 seconds; flash 2 - 0.5s light / 0.5s off; flash 3 - 0.5s light / 1.5s off.

5.3 Interface Introduction (Left Side)

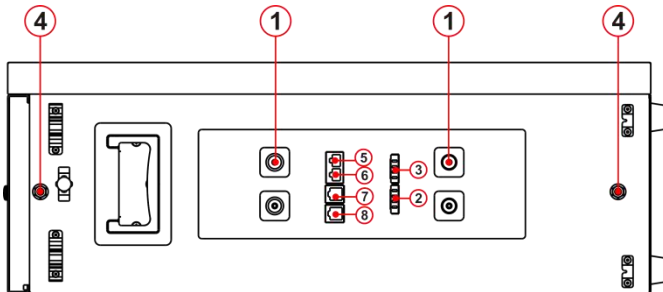

No.	Items	No.	Items
1	Power Terminals	5	Link Port In
2	Dry Contact Terminal	6	Link Port Out
3	Extend LCD Interface	7	RS232
4	Grounding	8	CAN/RS485

5.3.1 Wiring instructions

Applicable to CEC requirements in Australia only.

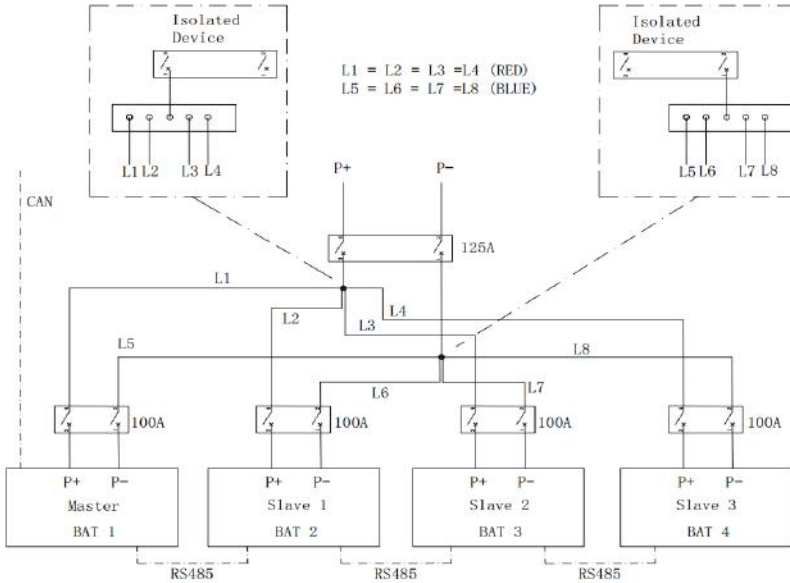

Note:

- 1、 Power Switch larger than 100A;
- 2、 You are advised to use the EV power cable with size min. 25 mm² or 3AWG (1000V, 100A) and length min.1500mm. The length of the power cable from connector terminals of each battery pack to the battery connector interface of PCS should be same by isolated device.

- 3、 Before assembling Power cable, label the cable polarities correctly to ensure correct cable connections.
- 4、 The power cable installation and connected must training skilled of professional personal.

Suggest Wiring Diagram (except CEC):

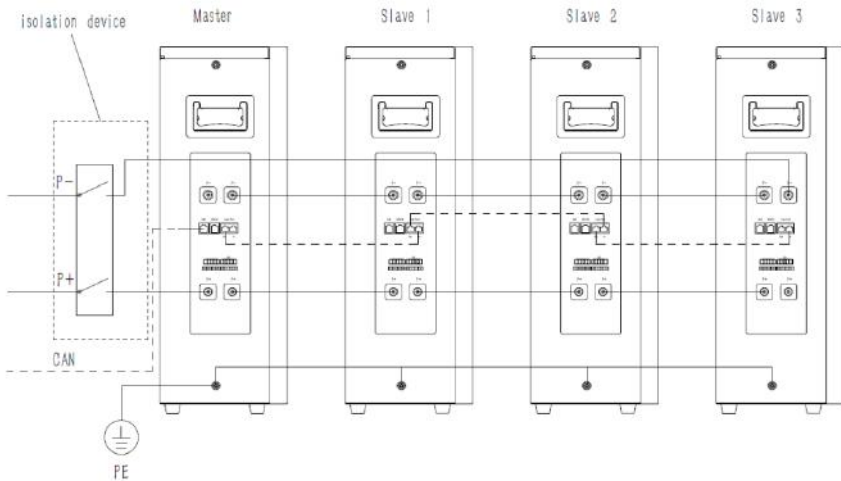

1、 Power cable wiring instructions

Power cable terminals: there are two pair of power terminals, each pair with same function.

Single module: Any of the terminals of each pair can be used.

Parallel system:

Multiple batteries can be connected in parallel to expand capacity and power for larger capacity and longer power supporting duration requirements.

NOTE: P+ must connect to master pack, and P- must connect to last slave pack.

Master pack: one of the P+ terminals connect to PCS, the other one paralleling to another battery for capacity expanding.

Last slave pack: one of the P- terminals connect to equipment, the other one paralleling to another battery for capacity expanding.

Other slave pack: for each pair terminals, paralleling to another battery for capacity expanding.

2、Parallel communication cable wiring instructions

Link Port In / Link Port Out communication terminal (RJ45 port) is integrated with the signal for automatic coding function, it's can automatic identification the parallel connected slave batteries by internal control software of master battery.

NOTE: The connection order of Port In and Port Out should not be wrong, otherwise it will lead to the automatic coding failed.

It is required that the Port In of the master PACK do not connected to the

communication line, and the parallel communication wire is connected to the Port In of the first slave PACK from the Port Out of the master PACK. Then the Port Out of the first slave PACK is connected to the Port In of the second slave PACK. The Port Out of the second slave PACK is then connected to the Port In of the third slave PACK. The parallel system support up to 4 parallel operation, and Port Out of the last slave PACK do not connected to the communication line.

3、PCS communication cable wiring instructions

The CAN communication port of the **Master pack** is connected to PCS.

4、Grounding wiring instructions

The ground wire of the battery system needs to be connected reliably. Connect the grounding of the parallel system first, and then ground it nearby through the connection point of one of the battery packs.

5.3.2 Link Port and Automatic Coding Function

Link Port In / Link Port Out Communication follow RS485 protocol, for communication between multiple parallel batteries.

After confirming the wiring is correct(refer to section 5.3.1), long press the startup button of the **Master PACK**, after normal startup, the parallel battery system will automatically code and assign ID to each parallel PACK, and then the parallel

system will run normally(refer to section 5.2.1).

5.3.3 CAN / RS485 Port

CAN / RS485 Communication Terminal(RJ45 port) follow CAN protocol / RS485 protocol, connect to communication port.

- 1、 BMS controls the charging current/charging voltage or discharge current/discharge cut-off voltage of the PCS through CAN communication according to the battery voltage and battery temperature.
- 2、 If the battery capacity is less than 8%, BMS controls the PCS to make compulsory recharge through the CAN communication to avoid the damage of the battery due to deep discharge.
- 3、 If SOC was less than 97% for one consecutive month, BMS controlled PCS by CAN communication to full charge the battery to corrected SOC and fully charged capacity.

Note: Through the Sofar Solar PCS, skilled peoples can set the fully charged time period, which is from 3AM to 6AM by default.

PIN	Definition
Pin 1、Pin 8	RS485-B (to PCS, reserved)
Pin 2、Pin 7	RS485-A (to PCS, reserved)
Pin 3	NC
Pin 4	CANH (to PCS)
Pin 5	CANL (to PCS)
Pin6	GND

5.3.4 RS232 Port

RS232 Communication Terminal(RJ45 port) follow RS232 protocol, for manufacturer or professional engineer to debug or service.

PIN	Definition
Pin 8、Pin 1	GND
Pin 2、Pin 7	RS232_TX
Pin 3、Pin 6	RS232_RX
Pin 4、Pin 5	NC

5.3.5 Output Dry Contact Terminal

Dry Contact Terminal: provided 2 output dry contact signal.



Pin	Definition	Note
NO1/COM1	Prohibit Charging;	Maximum load capacity : 30V/1A
NO2/COM2	Prohibit Discharging.	

5.3.6 Extend LCD Terminal

This interface can be connected to an extended LCD to display the detailed operation status of the battery.

Note: External LCD display is an optional accessory.



PIN	Definition
Pin 1	GND
Pin 2	RX
Pin 3	TX
Pin 4	VCC

External LCD information reference as follows:

```

> Analog Info >
--BMS Status >
--Para Setting >
--Sys Setting >
    
```

```

--Im: 0.00 A
--Temperature >
--Cell Voltage >
    
```

6 Installation Guide

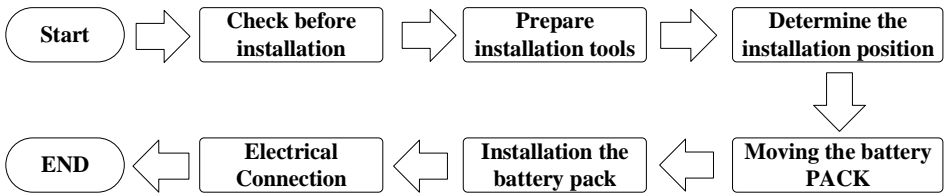

Installation flow chart

6.1 Checking Before Installation

6.1.1 Checking Outer Packing Materials

Packing materials and components may be damaged during transportation. Therefore, check the outer packing materials before installing the battery. Checking the surface of packing materials for damage, such as holes and cracks. If any damage is found, do not unpack the battery and contact the dealer as soon as possible. You are advised to remove the packing materials within 24 hours before installing the battery.









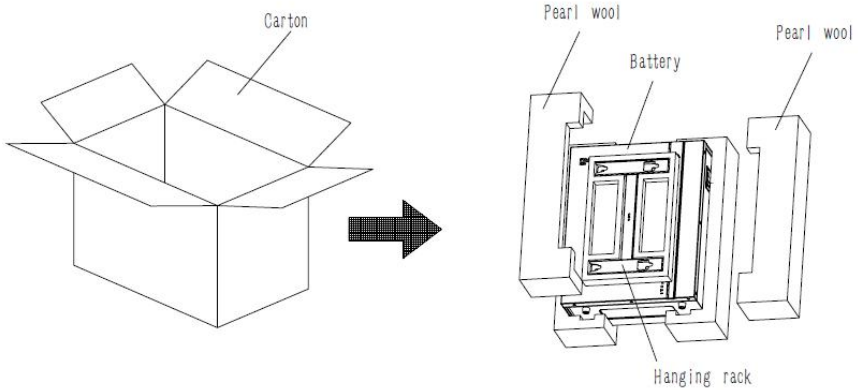

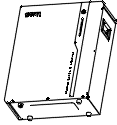
6.1.2 Checking Deliverables

After unpacking the battery , check whether deliverables are intact and complete.

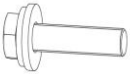



If any damage is found or any component is missed, contact the dealer.

The below table shows the components and mechanical parts that should be delivered.

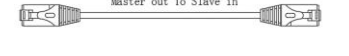
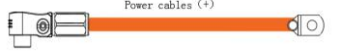

NO.	Pictures	Quantity	Description
1		1PCS	Battery
2		1PCS	Hanging rack
3		4PCS	Fixed leg
4		1PCS	Fixed support
5		1PCS	M6*60
6		4PCS	M10*60 Expansion bolts
7		4PCS	M6*16
8		1PCS	Manual
9		1PCS	Test report
10		1PCS	Certificate

The following accessories are configured according to the number of parallel machines in the battery system. For example:

NO.	Pictures	Quantity	Description
1		N-1 "*"	Parallel connections cable (P+)
2		N-1 "*"	Parallel connections cable "*" (P-)
3		N-1 "*"	Parallel communication cable "*" "
4		1pcs	Output Power cables (P+)
5		1pcs	Output Power cables (P-)
6		1pcs	Output communication cable

Note:

1. The standard output power cable is optional accessories component part, the customer can be according the actual installation requirements customize the output power cable from SofarSolar when the product sold in local or importers provide.
2. "*" N is indicate the parallel connections number of battery. The number of power cable and Communication cable is optional accessories according the parallel connection demand for customer.
3. you are advise use the provide standard accessories par from SofarSolar or customize the identical specification accessories component par from SofarSolar or importers.

Power cable terminal making instructions:

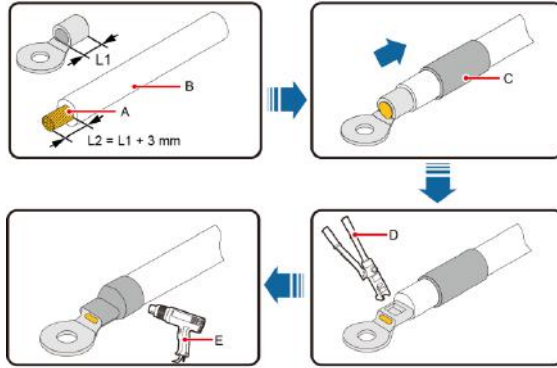



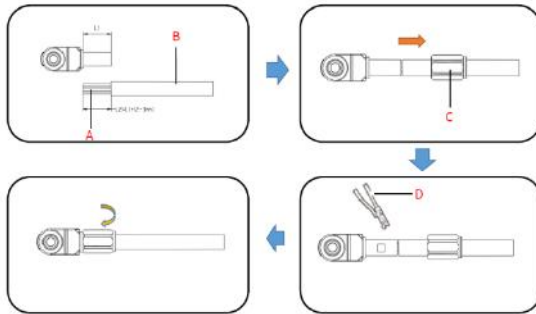





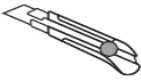



- (A) Core wire (B) Insulation layer (C) Heat shrink tubing
 (D) Hydraulic pliers (E) Heat gun



- (A) Core wire (B) Insulation layer (C) Protective cover
 (D) Hydraulic pliers

6.2 Tools

Model	Tools		
Installation	Knife 	Hammer drill (12mm) 	Socket wrench (10/16mm) 
	Rubber mallet 	Cross Screwdriver 	Marker 
	Incinometer 	Measuring tape 	
Protection	ESD gloves 	Safety goggles 	Anti-dust respirator 
	Safety shoes 		

6.3 Installation requirements

6.3.1 Installation environment requirements

- Install the battery in the indoor environment.
- Place battery in secure location away from children and animals.

- Do not place the battery near any heat sources and avoid sparks.
- Do not expose the battery to moisture or liquids.
- Do not expose the battery to direct sunlight.

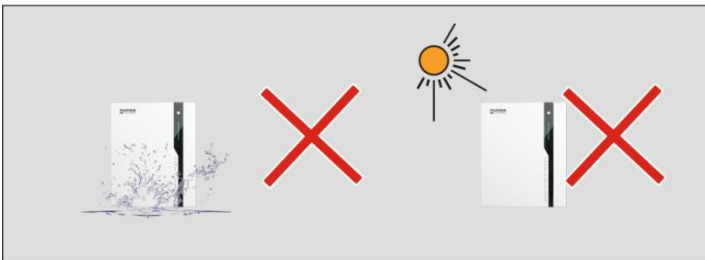
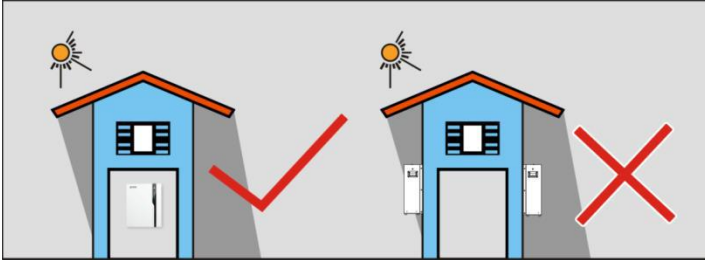

6.3.2 Installation carrier requirements

- The mounting carrier shall have fire resistance. Do not install batteries on flammable buildings.
- The mounting carrier surface shall meet the load bearing requirements.



6.4 Installation Method

- Suspended on wall



- Pedestal mounted



6.5 Installation Instructions

6.5.1 Dimensions

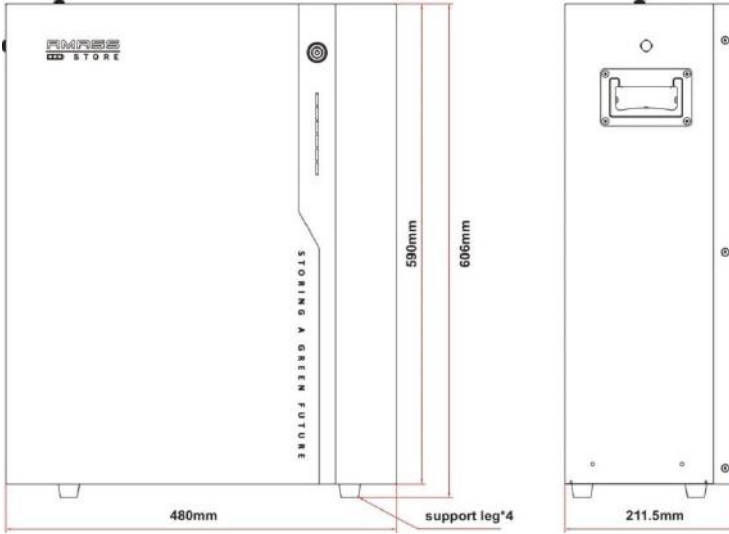

Battery size

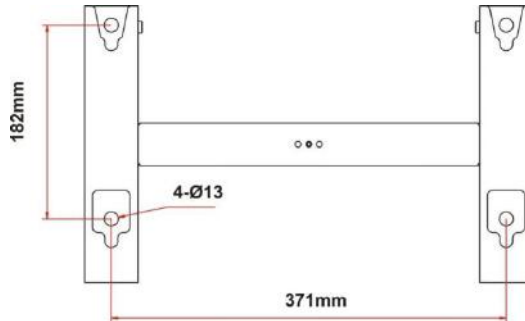

Hanging rack size

Minimum mounting distance between battery pack and other equipment:

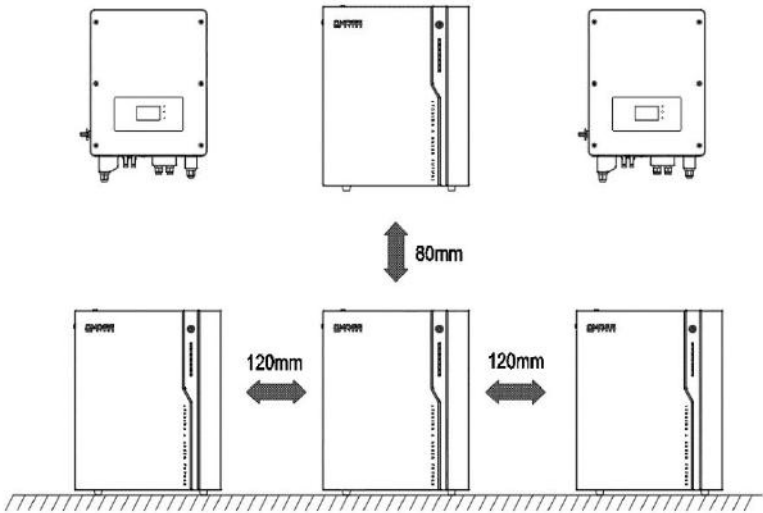
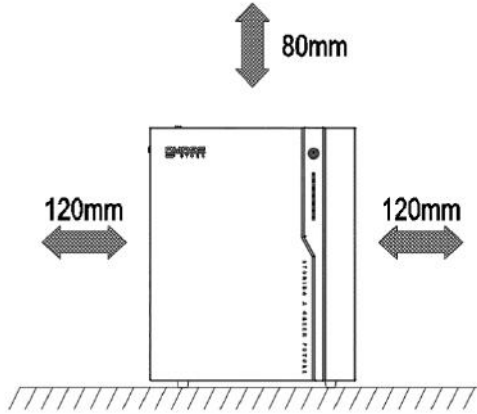

6.5.2 Single Machine Installation Step

6.5.2.1 Single Machine installation location requirements for suspended on wall

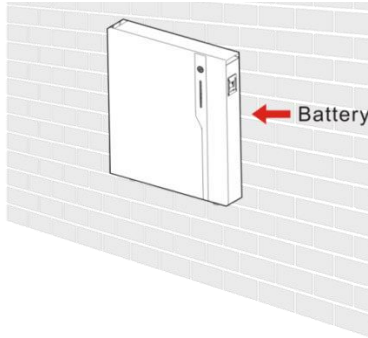

6.5.2.2 Single Machine installation step for suspended on wall

Step 1

To determine the position for drilling holes, and then mark the hole position by using a marker, use the hammer drill to drill hole on the wall. Keeping the hammer perpendicular to the wall, do not shake when drilling, so as not to damage the walls. If the aperture errors, need to reposition.

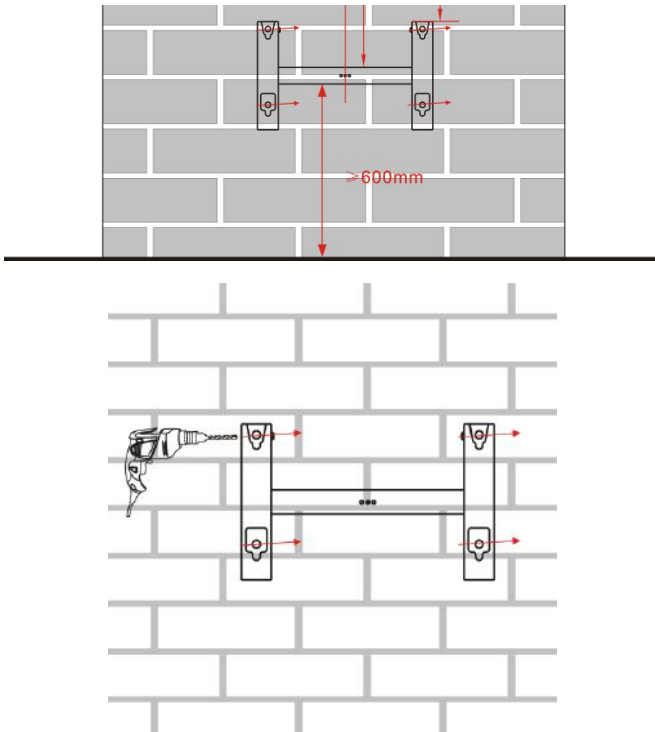

Step 2

Fix the wall hanger with expansion screws.

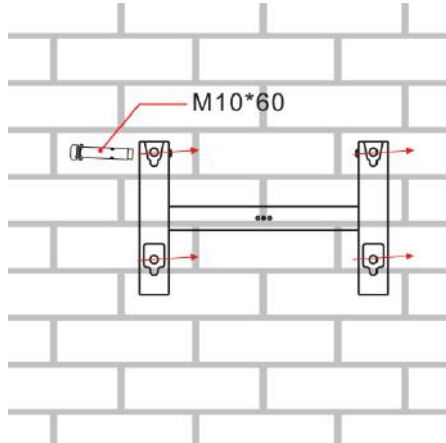

Step 3

Remove the battery and install the fixed leg.

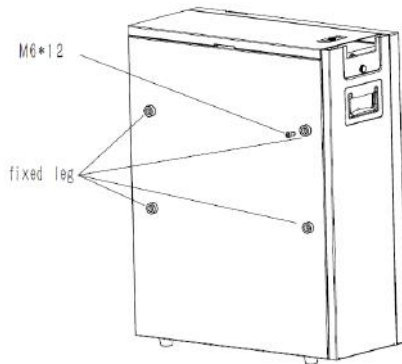

Step 4

Putting the battery hook on the hanging rack.

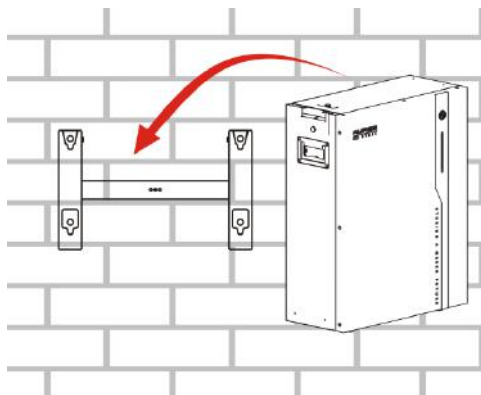

Step 5

Fix the fixing screw (left side or right side) to ensure the safety.



6.5.2.3 Single Machine installation location requirements for pedestal mounted

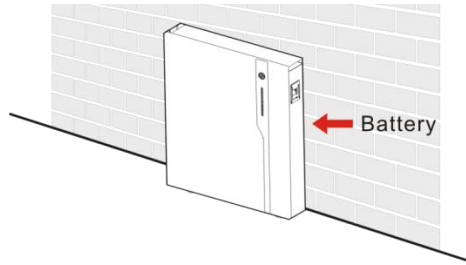

6.5.2.4 Single Machine installation step for pedestal mounted

Step 1

To determine the position for drilling holes, and then mark the hole position by using a marker, use the hammer drill to drill hole on the wall. Keeping the hammer perpendicular to the wall, do not shake when drilling, so as not to damage the walls. If the aperture errors, need to reposition.

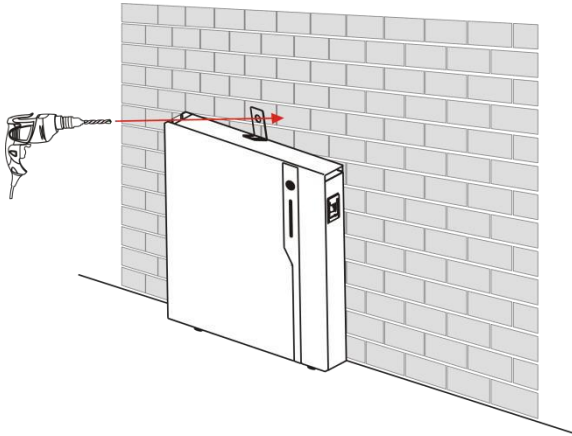

Step 2

Install the fixing plate to the battery, and then fix the mounting plate to the wall with expansion screws.

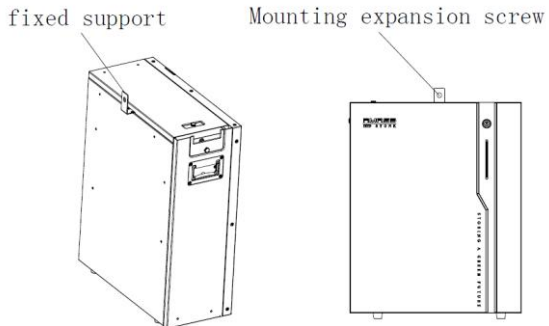

6.5.3 Parallel Machine Installation Step

6.5.3.1 Parallel Machine installation location requirements for suspended on wall

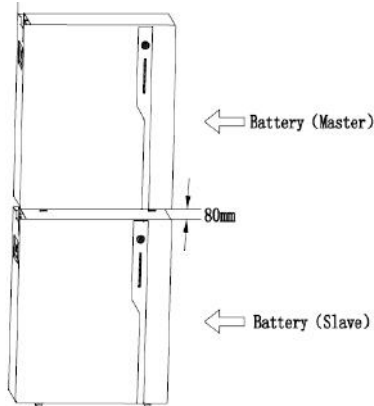

6.5.3.2 Parallel Machine installation step for suspended on wall

Step 1

According to the installation location requirements in section 6.5.3.1, determine the position for drilling holes, level hole positions, and then mark the hole position by using a marker.

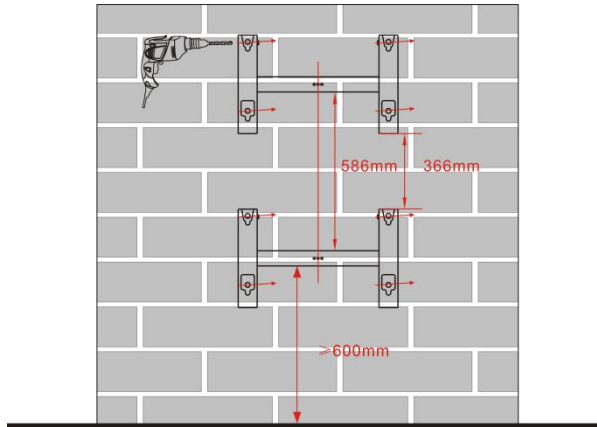

Step 2

Use the hammer drill to drill hole on the wall. Keeping the hammer perpendicular to the wall, do not shake when drilling, so as not to damage the walls. If the aperture errors, need to reposition.

Step 3

According to the installation instruction in section 6.5.2.2, install the top battery first, and then install the other one.

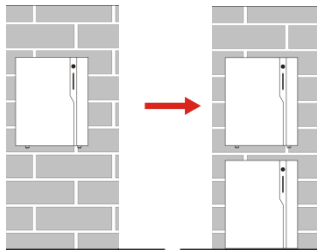

6.5.3.3 Parallel Machine installation location requirements for pedestal mounted

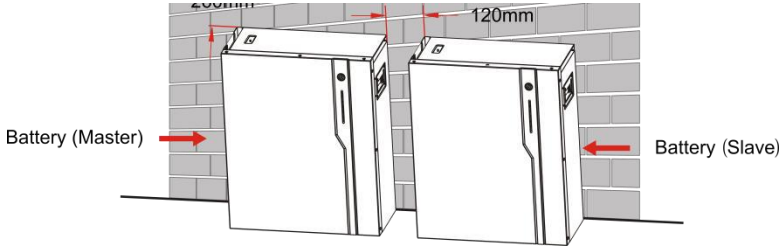

6.5.3.4 Parallel Machine installation step for pedestal mounted

Step 1

According to the installation location requirements in section 6.5.3.3, determine the position for drilling holes, and then mark the hole position by using a marker, use the hammer drill to drill hole on the wall. Keeping the hammer perpendicular to the wall, do not shake when drilling, so as not to damage the walls. If the aperture errors, need to reposition.

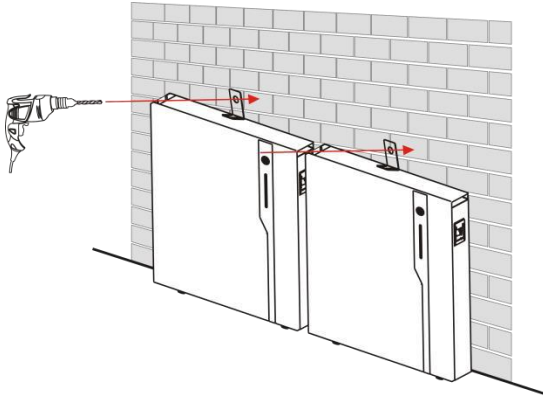

Step 2

Install the fixing plate to the battery, and then fix the mounting plate and the wall with expansion screws.

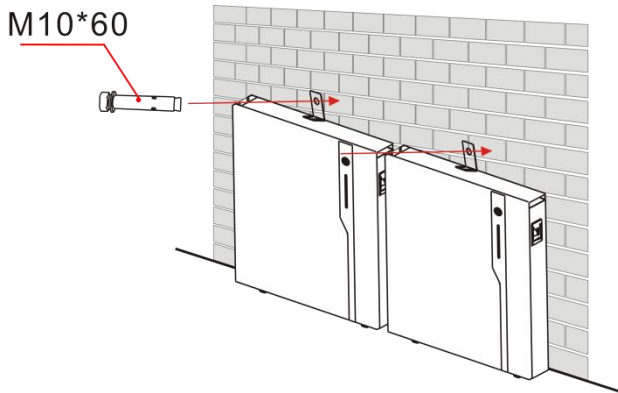

6.6 Electrical Connection

6.6.1 Electrical Connection Process

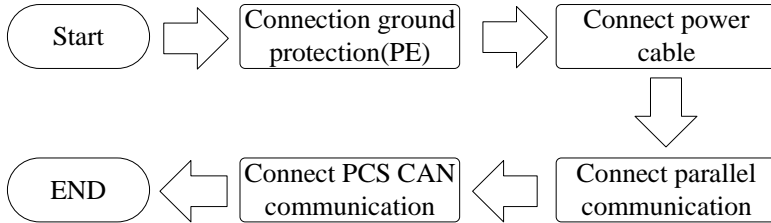

6.6.2 Single machine wiring step

Step 1

After finished installation (refer to section 6.5.2), remove side panel.

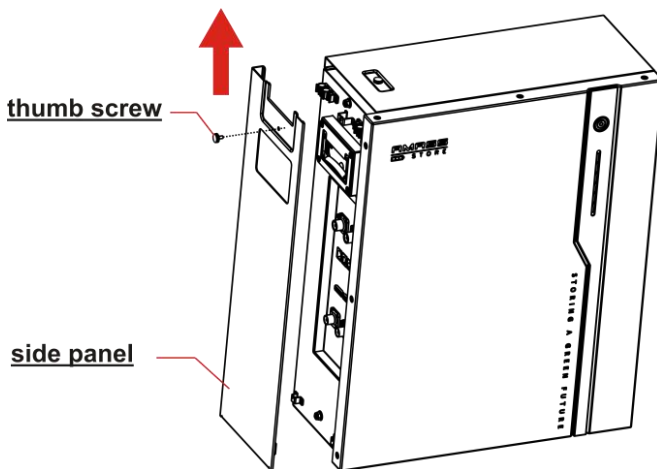

Step 2

Connect PE line.

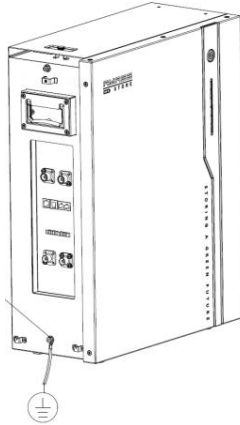
**Step 3**

Connect Power Cable from battery to isolation device.

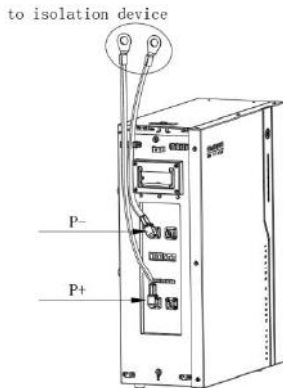

Step 4

Connect CAN communication line to communication port.

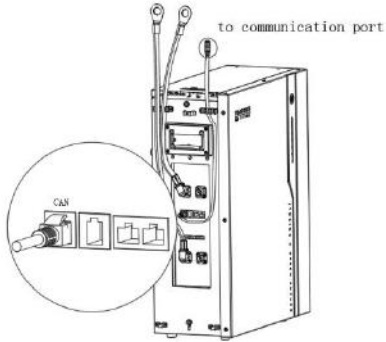
**Step 5**

Cover the side panel and fix screw.

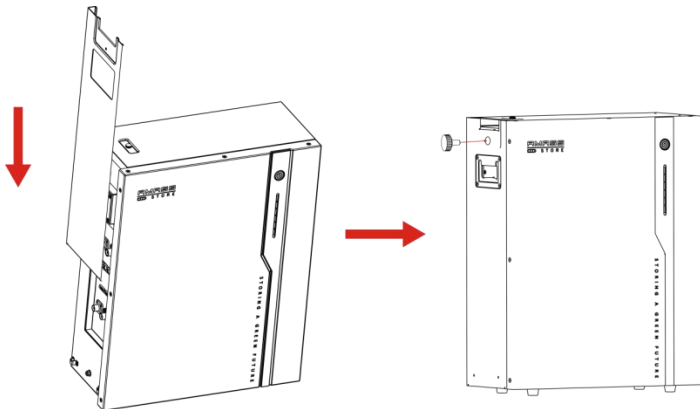

6.6.3 Parallel machine wiring step for suspended on wall**Step 1**

After finished installation (refer to section 6.5.3.2), remove side panel of all battery.

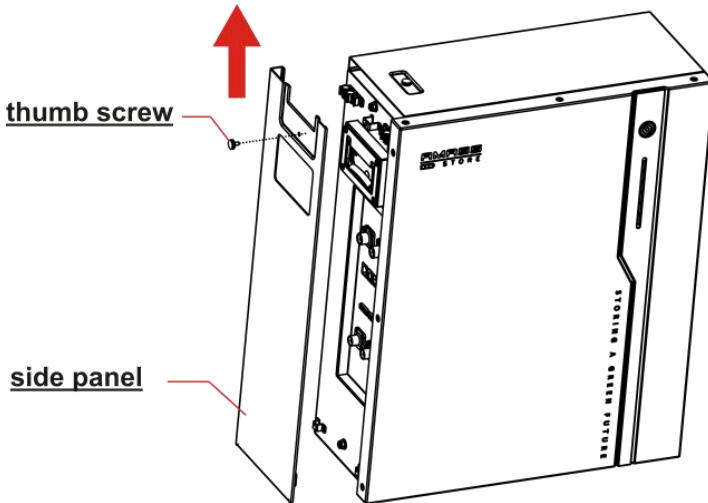

Step 2

Connect PE line.

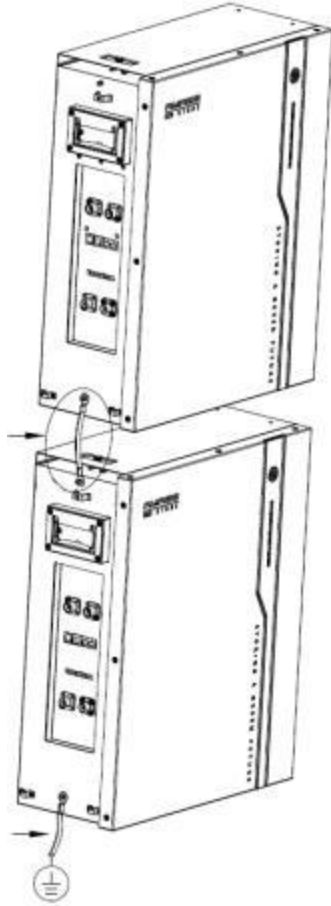

Step 3

Connect Parallel Power Cable between the master and slave batteries.

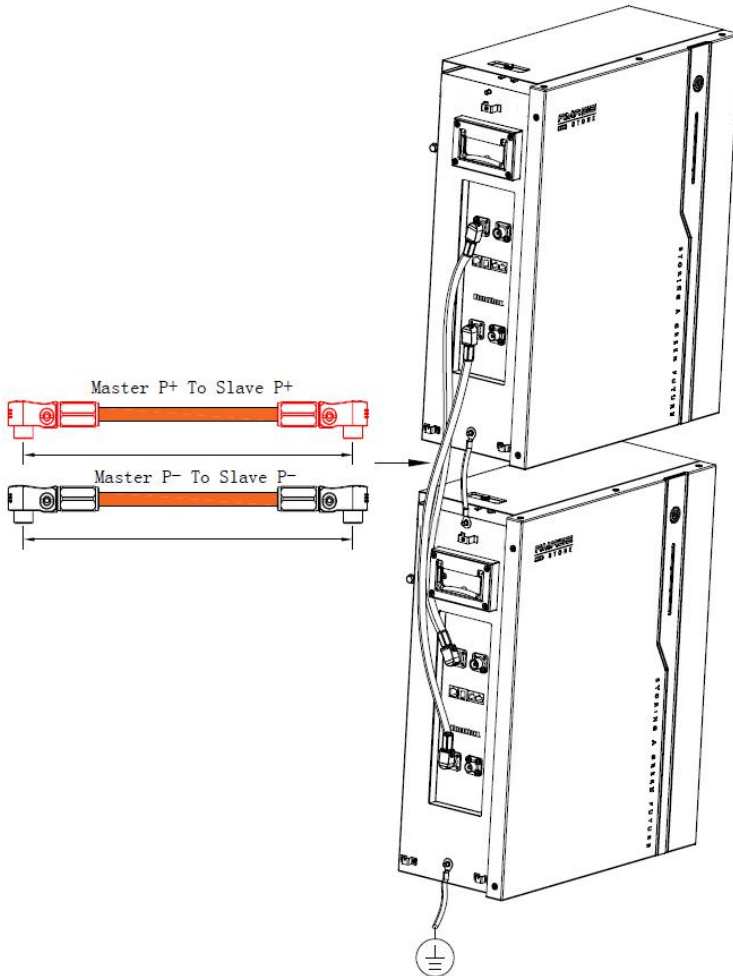

Step 4

Connect parallel communication line between the master battery and slave battery.

Note: Master Port Out connect to slave Port In.

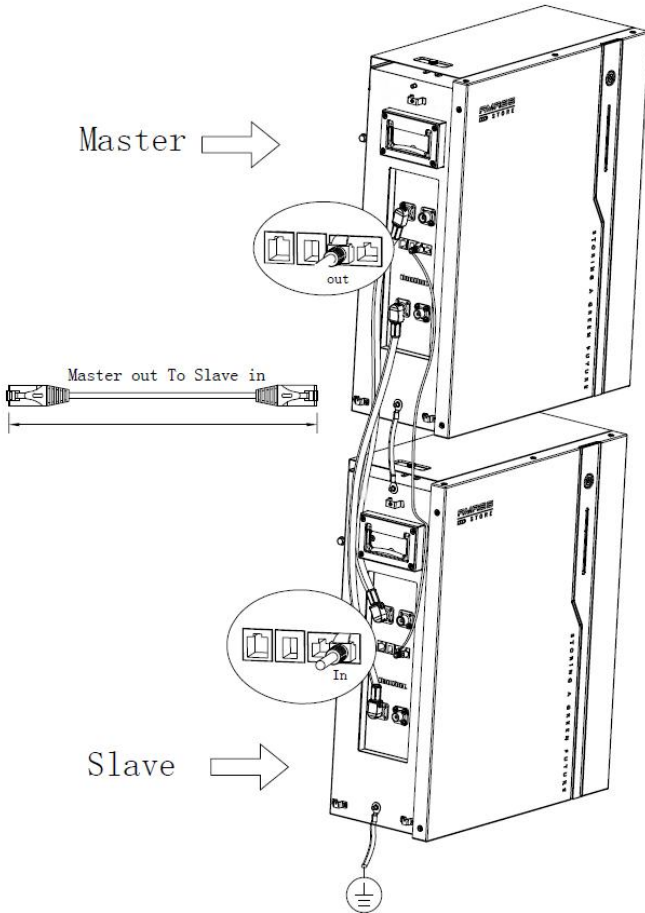

Step 5

Connect Power Cable (+) from master battery to isolation device, and connect Power Cable (-) from last slave battery to isolation device.

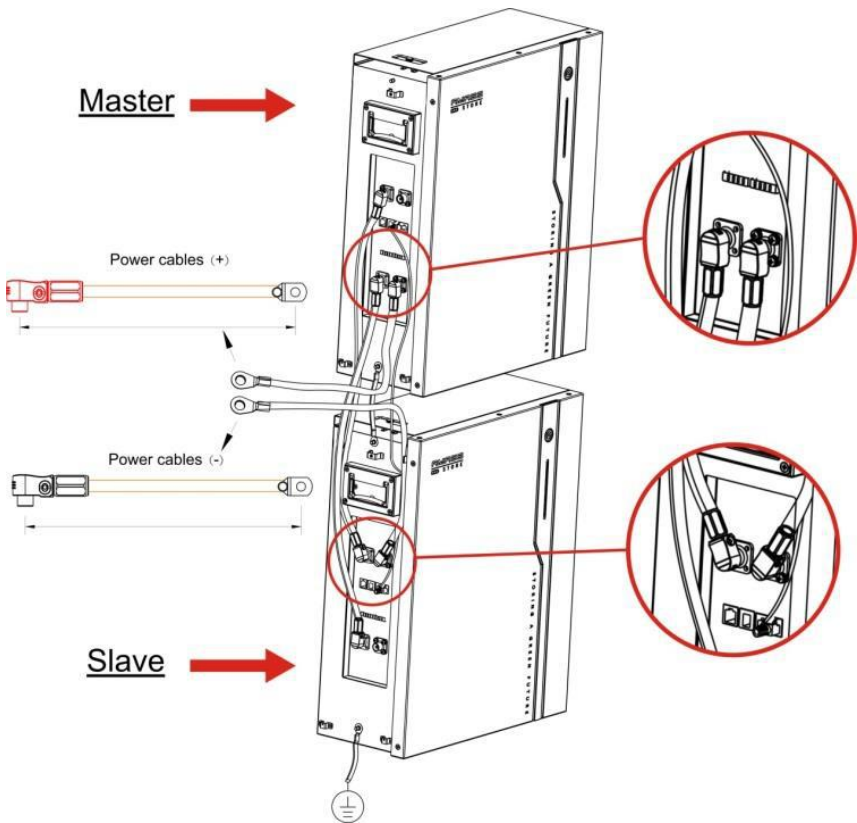

Step 6

Connect CAN communication line from master battery to communication port.

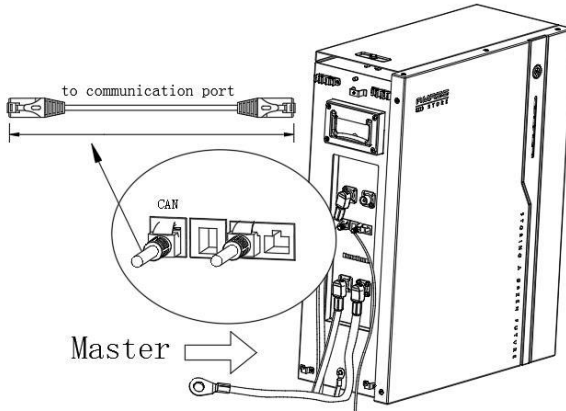
**Step 7**

Cover the side panel and fix screw of all battery.

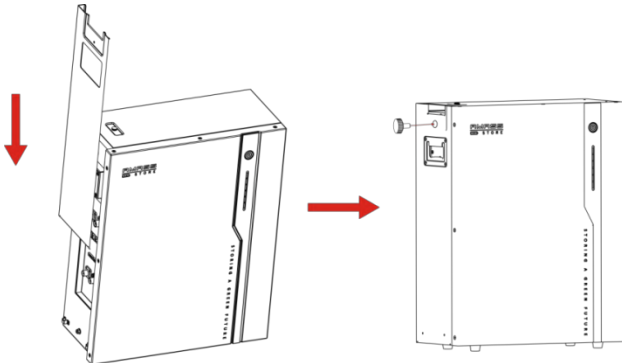

6.6.4 Parallel machine wiring step for pedestal mounted

Step 1

After finished installation (refer to section 6.5.3.4), remove side panel and top panel of master battery, and remove side panel of slave battery.

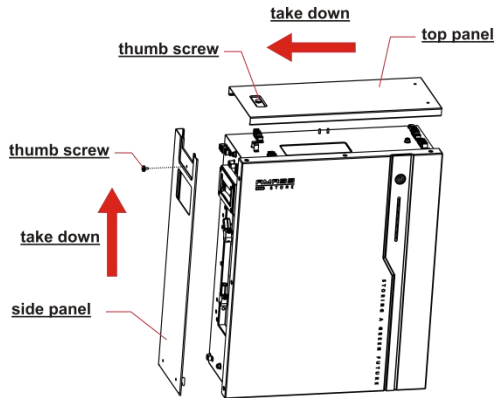
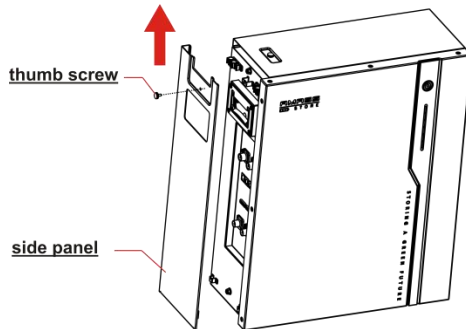
**Master battery****Slave battery**

Step 2

Slave battery wiring.

Connect below cable to slave battery:

- 1、 Parallel Power Cable P+;
- 2、 Parallel Power Cable P-;
- 3、 PE line;
- 4、 parallel communication line;
- 5、 Power Cable (-).

Note: Parallel communication line need connect to Port In of slave battery.

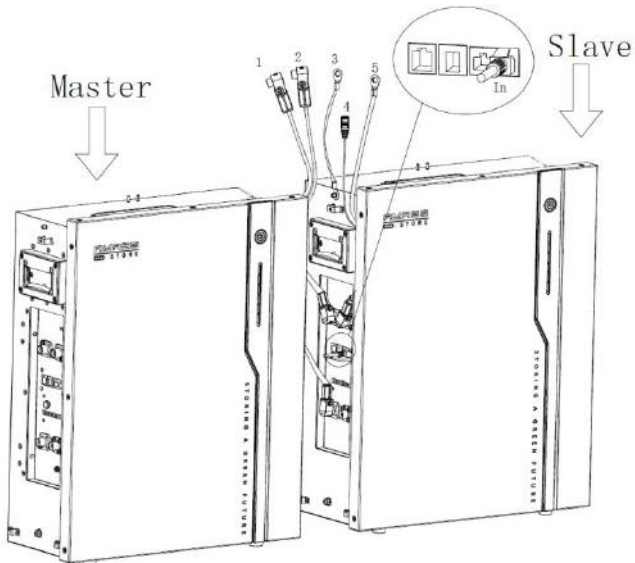

Step 3

Cover the side panel and fix screw of slave battery, and connect PE line.

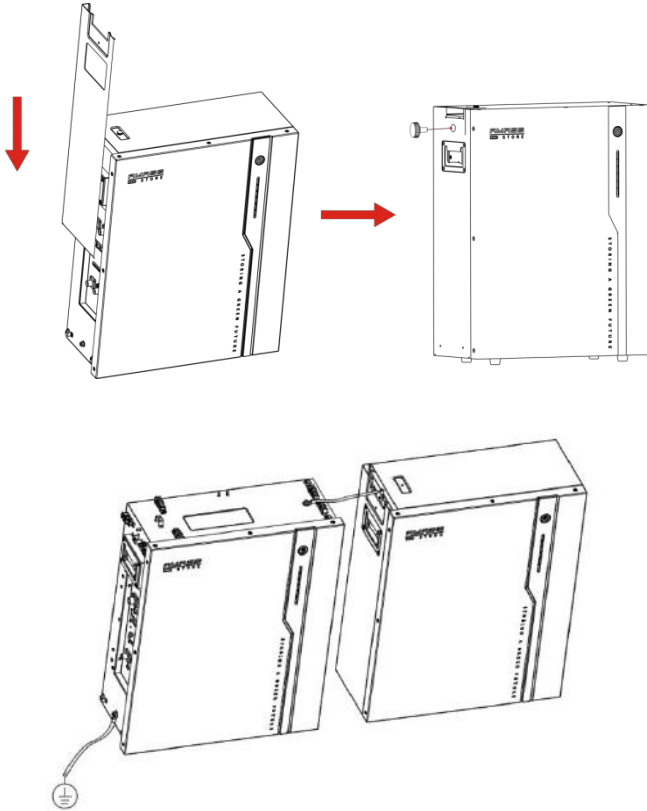
**Step 4**

Connect parallel communication line, parallel Power Cable P+, parallel Power

Cable P- from slave battery to master battery.

Note: Parallel communication line need connect to Port Out of master battery.

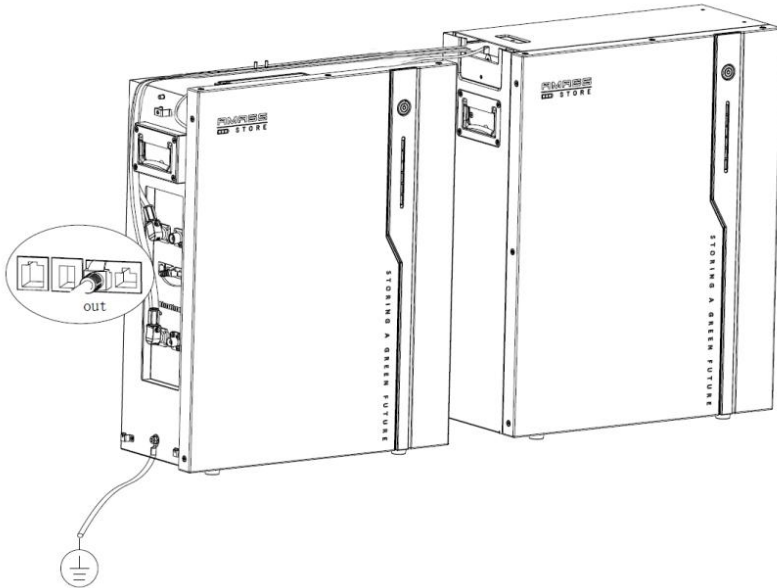

Step 5

Connect Power Cable (+) from master battery to isolation device, and connect Power Cable (-) from last slave battery to isolation device.

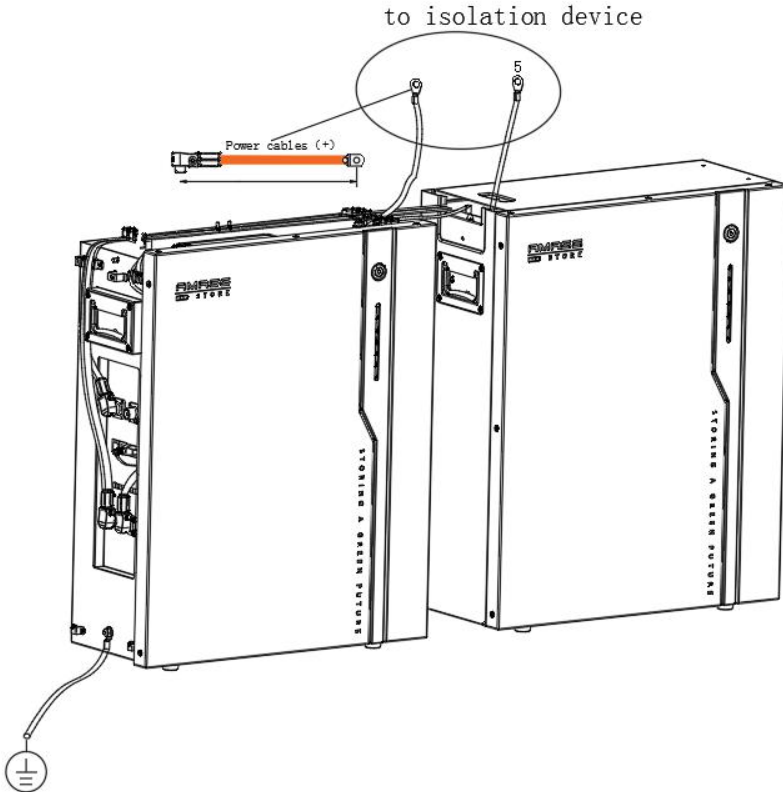

Step 6

Connect CAN communication line from master battery to communication port.

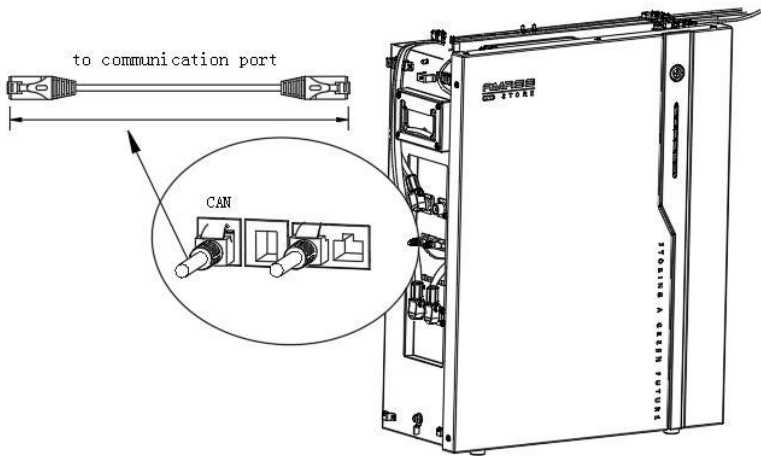

Step 7

Cover the side panel and top panel of master battery.

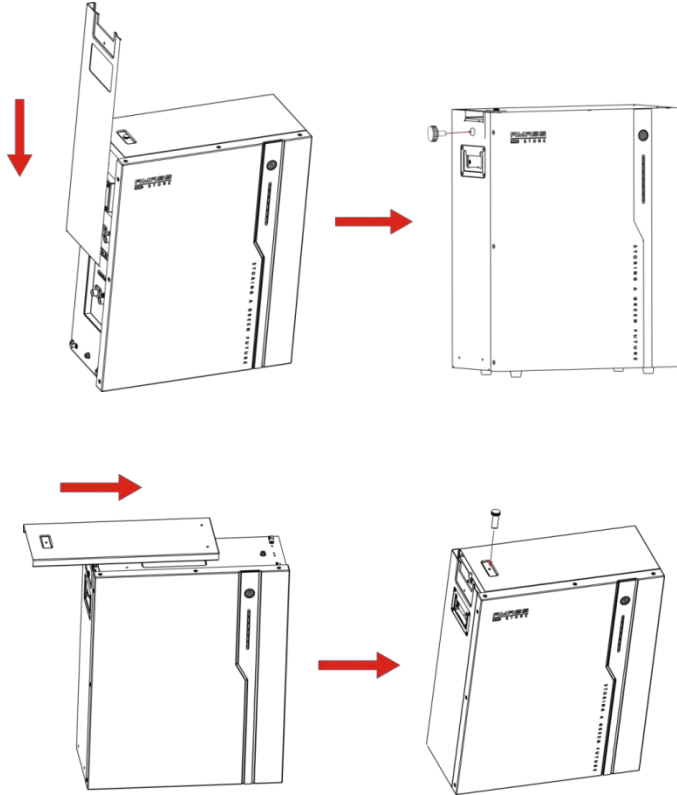

7 Cleaning and Maintenance

7.1 Cleaning

CAUTION:

Please power off the system before cleaning.

It is recommended that the AMASSTORE GTX5000 should be cleaned periodically. If the enclosure is dirty, please use a soft, dry brush or a dust collector to remove the dust. Liquids such as solvents, abrasives or corrosive liquids should not be used to clean the enclosure.

7.2 Maintenance

7.2.1 Recharge Requirements During Normal Storage

Batteries should be stored in an environment with a temperature range between $-10^{\circ}\text{C} \sim +45^{\circ}\text{C}$, and maintained regularly according to the following table with 0.5C (50A) current until 40% SOC after a long time of storage.

Recharge conditions when in storage

Storage Environment Temperature	Relative Humidity of Storage Environment	Storage Time	SOC
Below -10°C	/	prohibit	/
-10~25°C	5%~70%	≤12 months	30% ≤SOC ≤60%
25~35°C	5%~70%	≤6 months	30% ≤SOC ≤60%
35~45°C	5%~70%	≤3 months	30% ≤SOC ≤60%
Above 45°C	/	prohibit	/

7.2.2 Recharge Requirements When Over Discharged

Please recharge the over discharged (90%DOD) batteries in a timeframe that is in accordance to the following table, otherwise the over discharged battery modules will be damaged.

Recharge conditions when battery is over discharged

Storage Environment Temperature	Storage Time	Note
-10~25°C	≤15 days	Battery Pack disconnect to PCS
25~45°C	≤7 days	
-10~45°C	< 12 hours	Battery Pack connect to PCS

7.2.3 Replacement or expand capacity

The maintenance of batteries requires a person with professional skills.

- 1、 Before replacement or expand capacity, please cut off the whole system, include PCS and Battery system; at the same time, PCS is disconnected from the power grid;
- 2、 After PCS is confirmed to be disconnected from the power grid, turn off the battery power supply and disconnect the connection line between the battery and PCS.
- 3、 Remove or install new battery refer to section 6.5, and then restart refer to section 5.2.1.

8 Common Issues and Solutions

8.1 Common Issues and Solutions

User can monitor the running status, warnings and alarms information from the App or LCD display of PCS, or battery extend LCD.

1、 Battery cannot turn on, and LED indicator all off

Battery deep discharge, need to charge first. If the external charger power supply voltage is 51V or more, the battery still unable to turn on, please contact Sofar.

2、 The battery can be turned on, but cannot charge or discharge

If the red light is lighting, that means system is abnormal, please check values as following:

a) Temperature protect: Above 55°C or under 0°C, battery protection will turn on.

Solution: to move battery to the normal operating temperature range.

b) Current: If current is greater than 100A, battery protection will turn on.

Solution: If operating current is too large, change the settings on power supply side.

c) High Voltage: If battery voltage above 56V or more, battery charge protection will turn on.

Solution: If battery is full charge, please discharge the battery for some time; if charging voltage is too high, change the settings on power supply side.

d) Low Voltage: When the battery discharges to 45.6V or less, battery discharge protection will turn on.

Solution: Charge the battery until the red light turn off.

Excluding the five points above, if the faulty is still cannot be located, turn off battery and contact Sofar.

3. In parallel system, SOC indicator display is different

a) For the first installation, please make a full charge first to balance the capacity gap;

b) If the lowest SOC LED indicators is only one less than the highest SOC LED indicators, and SOC LED indicator will become same within 10 minutes, it is a normal running status;

c) Before expand capacity for online battery, please charge or discharge the online battery to 45%-50% SOC; after expand capacity, please full charge the battery system to balance the capacity gap.

Make sure the capacity gap no more than 80% before parallel. If capacity gap is large, it will take about 2 cycles to balance the capacity gap. The real balance time depend on the capacity gap and charge or discharge current.

NOTE: Before expand capacity or update software, please cut off the whole system, include PCS and Battery system.

Excluding the three points above, if the SOC display faulty still exist, please contact Sofar.

8.2 Emergency

Please cut off the power supply and turn off the battery in an emergency.

1) Wet Batteries

If the battery pack is wet or submerged in water, do not let people access it, and then contact Sofar or an authorized dealer for technical support.

2) Fire

NO WATER! Only dry powder fire extinguisher can be used; if possible, move the battery pack to a safe area before it catches fire.

3) Leaking Batteries

If the battery pack leaks electrolyte, avoid contact with the leaking liquid or gas. If someone is exposed to the leaked substance, immediately perform the actions

described below.

Inhalation: Evacuate the contaminated area, and seek medical attention.

Contact with eyes: Rinse eyes with flowing water for 15 minutes, and seek medical attention.

Contact with skin: Wash the affected area thoroughly with soap and water, and seek medical attention.

Ingestion: Induce vomiting, and seek medical attention.

4) Damaged Batteries

Damaged batteries are dangerous and must be handled with the utmost care. They are not fit for use and may pose a danger to people or property. If the battery pack seems to be damaged, pack it in its original container, and then return it to Sofar or an authorized dealer.



Product Name: Lithium-Ion Storage Battery

Company Name: Shenzhen SOFARSOLAR Co., Ltd.

ADD: 401, Building 4, AnTongDa Industrial Park, District 68, XingDong Community,
XinAn Street, BaoAn District, Shenzhen, Guangdong.P.R. China

Email: service@sofarsolar.com

Tel: 0510-6690 2300

Web: www.sofarsolar.com