



ShineSEM-X Operation Manual V1.0

SHENZHEN GROWATT NEW ENERGY CO.,LTD

4-13/F, Building A, Sino-German(Europe) Industrial Park,
Hangcheng Ave, Bao'an District, Shenzhen, China

T + 86 755 2747 1942

F + 86 755 2747 2131

E service@ginverter.com

W www.ginverter.com

CONTENT

1 About this manual

- 1.1 Manual Description
- 1.2 Copyright Notice
- 1.3 Applicable personnel
- 1.4 Manual usage

2 Product introduction and installation

- 2.1 Product appearance and internal structure
- 2.2 Introduction to working principle
- 2.3 Unpacking
- 2.4 Installation
- 2.5 Wiring instructions
- 2.6 Ring Network Wiring
- 2.7 Cable Specifications

3 Operation and application

- 3.1 ShineMaster-X operation introduction

4 Specification parameters and model description

- 4.1 Specification parameters
- 4.2 Model description

5 contact us

1 About this manual

1.1 Manual description

Dear user, thank you for using the ShineSEM-X developed and produced by Shenzhen Growatt New Energy Co., Ltd. (hereinafter referred to as Growatt). Performance and functionality make more comments. The purpose of this manual is to provide users with detailed product information and instructions for installation, operation and maintenance.

1.2 Copyright notice

The copyright of this user manual is owned by Growatt. No part or all of this user manual may be excerpted, reproduced or transmitted in any form, including information and publications, by any entity or individual without our written permission. Infringement of which will be prosecuted.

The version number of this manual is V1.0. Growatt has the final right to interpret this user manual. In case of changes in product parameters, appearance, packaging, etc., the latest information of the company shall prevail without prior notice.

1.3 Applicable personnel

This manual is intended for technical professionals who install, commission and maintain the ShineSEM-X and for users who carry out routine operations. If necessary, please refer to the appropriate user information from Growatt.

1.4 Manual usage

Please read this manual carefully before installing and using the smart array communication box. Also, keep this manual in a safe place where it can be easily found by operating and maintenance personnel. The contents of this manual are subject to constant updating and correction and there will inevitably be minor discrepancies or errors with the actual product. Users are advised to refer to the actual product purchased, and can download the latest user manual through oss.growatt.com, or obtain the latest user manual through Growatt's sales or service channels.

Product introduction and installation 2

2.1 Product appearance and internal structure

2.1.1 Appearance

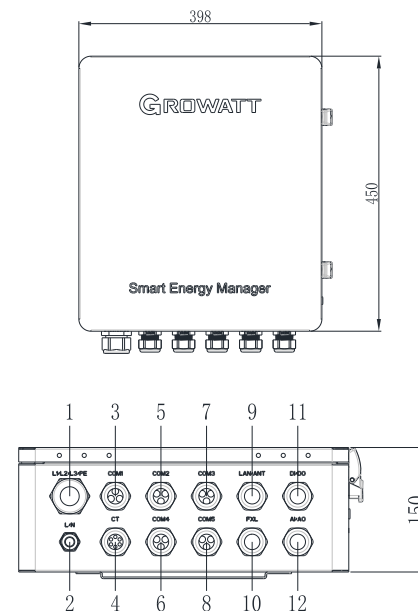

Figure 2-1 Appearance (unit: mm)

Serial number	Label	Illustrate
1	L1/L2/L3/PE	Three-phase voltage interface
2	L/N	Single-phase voltage interface
3	COM1	RS485-1 interface
4	CT	Current transformer interface
5	COM2	RS485-2 interface
6	COM4	RS485-4 interface
7	COM3	RS485-3 interface
8	COM5	CAN bus interface
9	LAN/ANT	Network cable/antenna interface
10	FXL	Fiber optic interface
11	DI/DO	Digital signal input and output interface
12	AI/AO	Analog signal input and output interface

2.1.2 Internal structure

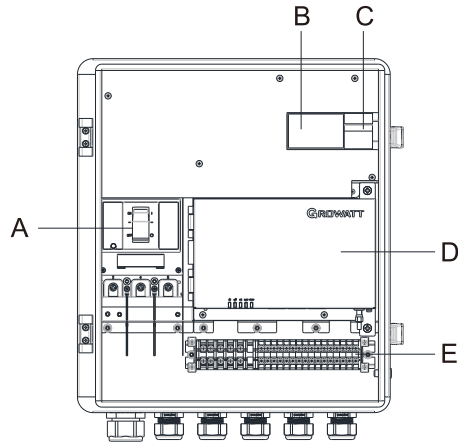

Figure 2-2 Internal structure

Serial number	Illustrate
A	Breaker
B	Meter (optional)
C	Air disconnect switch
D	ShineMaster-X Collector
E	Terminals

The ShineSEM-X is mainly composed of ShineMaster-X, electric meter, air isolating switch, circuit breaker, and terminal block

The functions of each part are as follows:

1. ShineMaster- X : the control core, which communicates with the inverter and the meter to realize the functions of remote monitoring, setting, upgrading, and collecting relevant operating information of the inverter.
2. Electric meter: Real-time monitoring of parameters such as voltage, current and power.
3. Air isolation switch: It can control the start and stop of ShineMaster-X and PLC power supply .
4. Circuit breaker : Control the start and stop of the three-phase high voltage input .
5. Terminal block: where the user makes connections.

2.1.2.1 ShineMaster status LED light

ShineMaster- X status LED lights, which can display the running status of ShineMaster-X.

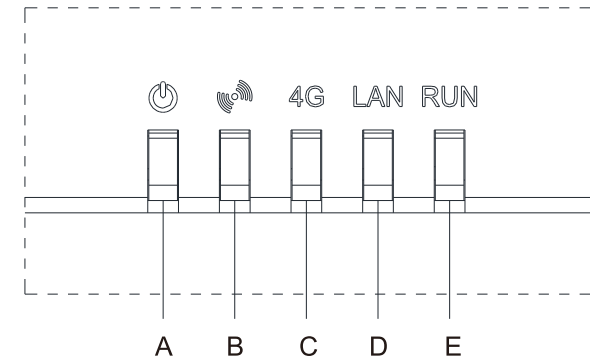

Figure 2- 3 Indicator lights

Indicator light	Meaning
A. Power indicator Power LED	Always off: The power supply is working abnormally; Steady on: The power supply is working normally.
B. Bluetooth indicator BLE LED (not currently supported)	Always off: Bluetooth is not enabled; 1S blinks 1 time, off 1 time: Bluetooth is enabled, but not connected to the mobile APP ; Steady on: Bluetooth works normally and is connected to the mobile APP normally.
C. 4G indicator 4G LED	Always off: does not support 4G function; 1S blinks 2 times, off 1 time: no SIM card inserted 1S blinks 1 time, off 1 time: 4G network is abnormal or SIM has no traffic; Steady on: The 4G network is normal.
D. LAN indicator LAN LED	Always off: the network is not connected; 1S blinks 1 time, off 1 time: Obtained a valid IP , no network data interaction. That is, the connection with the server is abnormal.
E. Status Indicator RUN LED	Steady off: The system is working normally without any alarm or fault; Blinking blue light: the system has an alarm; for example: abnormal connection to the server, abnormal communication of monitoring equipment, etc. Steady red light: There is a system failure. For example: The SD card is not working properly. The MMC memory chip is not working properly. The anti-backflow function fails. Lightning protection alarm, third-party alarm signal, etc.

2.1.2.2 Air isolating switch

The switch is switched off by default at the factory. The power meter and ShineMaster-X are in a powered off state. The power meter and ShineMaster-X work properly when powered up.

2.1.2.3 Wiring terminal block

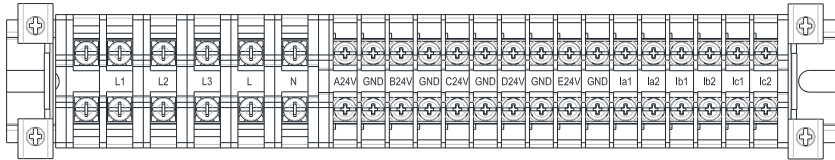

Figure 2-4 Terminal block

21 wiring ports in the terminal block, which are as follows from left to right:

- (a) Three-phase voltage output interface (L 1 , L 2 , L 3)
- (b) Single-phase power input interface (L, N)
- (c) 24 V voltage output ports (A 24 V, B 24 V, C 24 V, D 24 V, E 24 V, GND)
- (d) Current transformer interface (Ia1, Ia2, Ib1, Ib2, Ic1, Ic2).

2.1.2.4 Circuit breaker

The factory default is OFF and the three phase input is in the OFF state. After the operator has connected all the wiring to the intelligent sub-array communication box, turn the switch upwards so that the switch is ON. Then three phase input will be normal .

2.1.2.5 Electric surface panel

The ammeter is an optional component, and it is used with the anti-reflux box

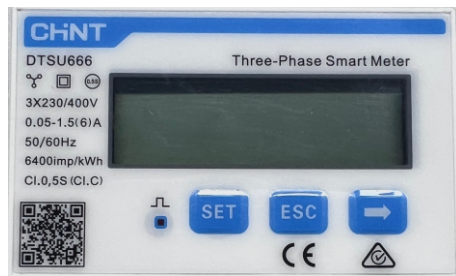

Figure 2-5 Electrometer panel

The electrical panel can display various electrical parameters: voltage, current, active energy, active power, power factor, etc. The display interface and setting parameters can be switched through the 3 buttons at the bottom of the panel, click "→" to switch to the next interface, and click "ESC" to switch to the previous interface, see chapter 3.3 for details.

2.1.2.6 Current transformer

The ShineSEM-X with different system capacities will be delivered with different types of open-type current transformers, which are used to detect the current of the grid-connected access point in the low-voltage power distribution system. The specifications are shown in the following table:

System capacity	Current ratio	Precision	Core turns	Dimensions (mm) W*H*D	Perforation size (mm) a*e
100KW	250/5A	0.5	1	90*114*40	22*32
300KW	600/5A	0.5	1	114*140*36	42*62
600KW	1200/5A	0.5	1	144*199*36	82*122
1MW	2000/5A	0.5	1	184*254*52	82*162
2MW	4000/5A	0.2	1	184*254*52	82*162

Note:

1. The total power of inverters or loads in the entire system cannot exceed the corresponding system capacity of the ShineSEM-X.
2. Under any conditions, the current flowing through the primary side of the current transformer (CT) cannot exceed its maximum detection range.
3. Avoid running the current transformer in high-humidity environment.

2.2 Introduction to working principle

The working principle of the smart array communication box is as follows:

1. The inverter converts the direct current generated by sunlight irradiating the photovoltaic string into alternating current,
2. The electric energy generated by the inverter can be used for user load or output to the grid,
3. The ShineSEM-X is located between the inverter, the user load and the grid, and communicates with the inverter through PLC or RS485 .

The block diagram of photovoltaic grid-connected anti-backflow system is as follows:

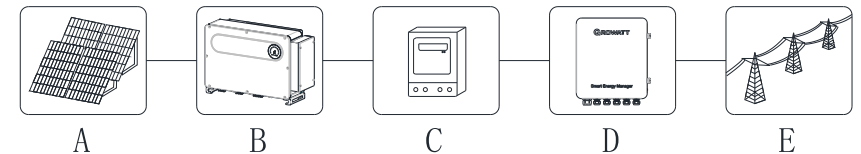

Figure 2-6 Photovoltaic grid-connected anti-backflow system

Symbol	Illustrate	Symbol	Illustrate
A	Photovoltaic string	B	inverter
C	Load	D	Wisdom Subarray Communication Box
E	power grid		

2.3 Unpacking

The main accessories of the smart array communication box are as follows:

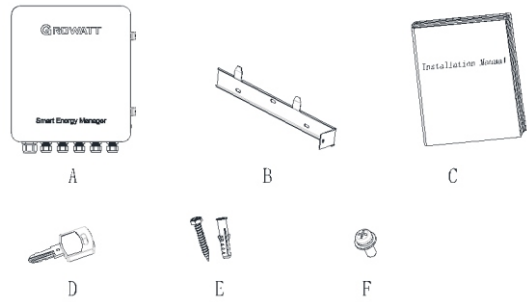

Figure 2-7 Accessory diagram

Serial number	Describe	Quantity
A	ShineSEM-X	1
B	Fixed wall-mounted	1
C	Installation Manual	1
D	Case key	2
E	Expansion screw	3
F	Set screw	1

2.4 Installation

Referring to the drawing method in the figure below, drill two holes in the wall and insert the plastic expansion tubes, lock the self-tapping screws on the plastic expansion tubes, fix the fixed wall hanging of the ShineSEM-X to the wall, and then install the Hang up the communication box of the smart sub-array, and lock the screws to complete the installation.

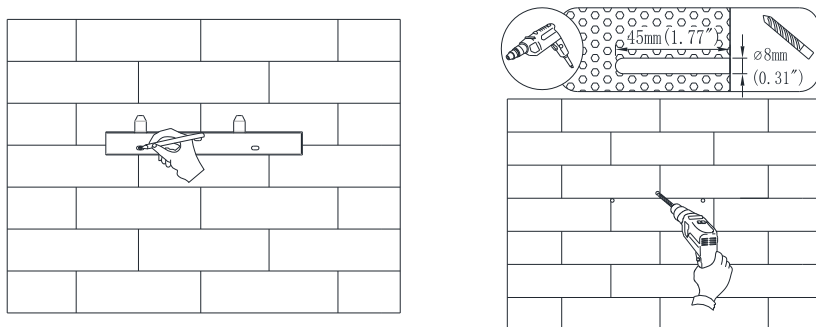

Figure 2-8 Pointing and punching

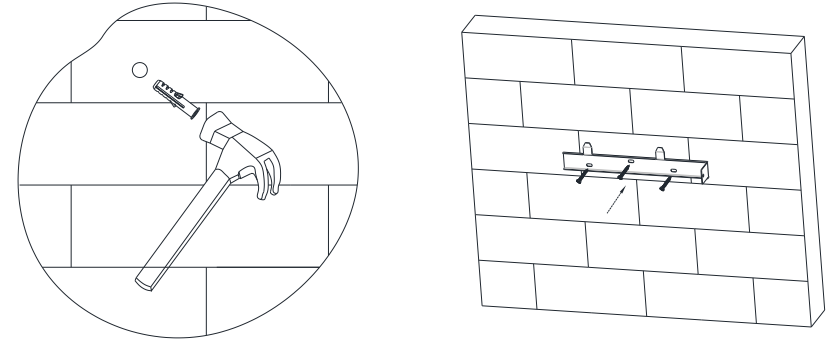

Figure 2-9 Install the knock-on screw cover and fix the wall mount

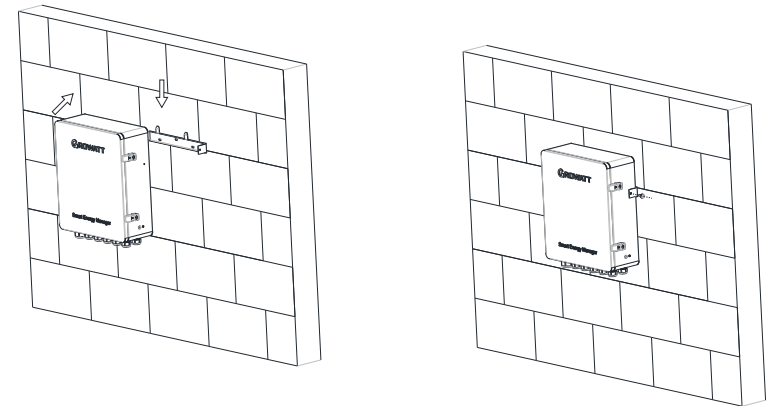

Figure 2-10 Installation and fixing

Note: This product is supplied with a special key to lock the upper cover, which can be operated by the customer according to the actual situation.

2.5 Wiring instructions

Open the upper cover of the communication box of the smart array, and connect according to the figure below. In the absence of an electric meter in the ShineSEM-X, the three current transformers and the voltage sampling interface do not need to be connected.

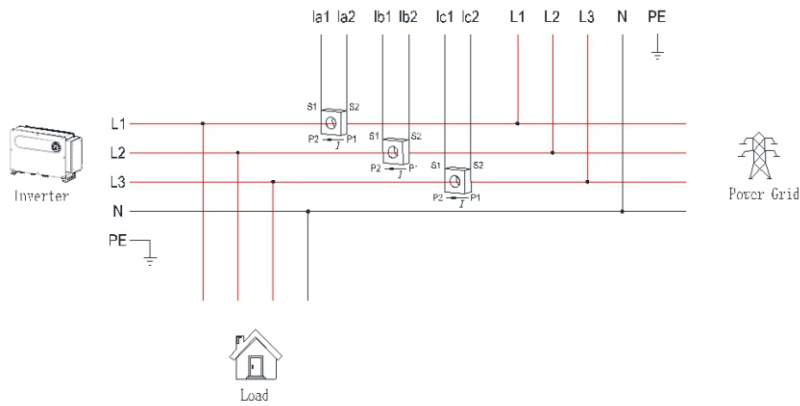

Figure 2-11 Wiring diagram

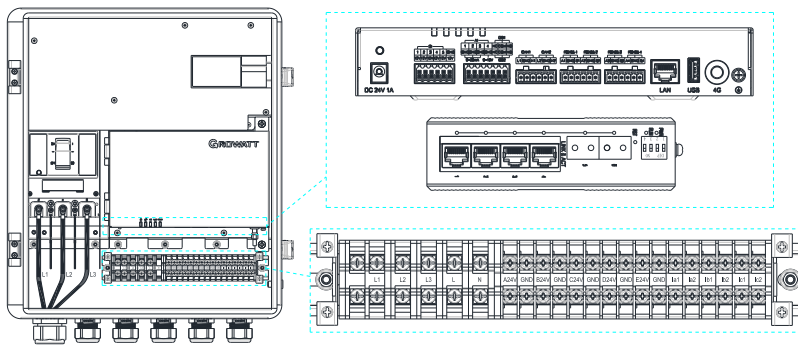

Figure 2-12 Interface terminal diagram

1. Overall wiring

As can be seen from the figure above, the three CTs and AC voltage sampling lines need to be placed between the load and the grid to detect the power of the grid-connected access point in real time. The ShineSEM-X is recommended to be installed near the power distribution cabinet of the grid. The CT and AC voltage sampling lines are placed in the power distribution cabinet.

2. RS485 interface

The ShineSEM-X is used to connect the RS485 interface of the inverter. For the wiring method of multiple inverters, please refer to the following figure. The precautions are as follows:

- (1) The RS485 wire is recommended to use twisted-pair shielded wire, and the shielding layer is connected to the GND pin of the RS485 interface of the ShineSEM-X and the inverter.
- (2) A maximum of 32 inverters can be connected, that is, $n \leq 32$. Refer to the wiring diagram and connect them hand in hand.
- (3) The collector and the inverter should be connected in a hand-in-hand manner, and the RS 485 interface of the last inverter should be connected to the grounding terminal of the casing to prevent the 485 communication from being interfered.

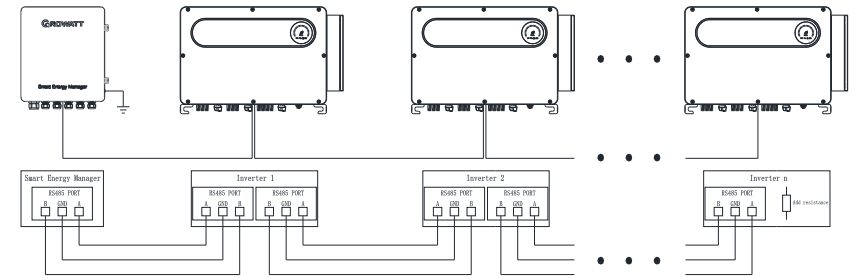

Figure 2-13 RS485 wiring diagram

3. Current transformer interface

There are P1 and P2 silk screens on both sides of the current transformer to distinguish the direction. Refer to Figure 2-5 for wiring. The P1 side is close to the inverter and load. The transformer connection method is as follows:

- (1) S1 of inverter L1 phase current transformer CT1 is connected to ia1, S2 is connected to ia2,
- (2) S1 of inverter L2 phase current transformer CT2 is connected to ib1, S2 is connected to ib2,
- (3) S1 of inverter L3 phase current transformer CT3 is connected to ic1, S2 is connected to ic2,

Precautions:

- (1) Before the transformer is installed, its secondary must be connected to the ShineSEM-X to ensure that the secondary of the transformer is not open.
- (2) If the on-site primary busbar is a cable, professional electrical personnel can carry out live installation; if the primary busbar is a copper bar, the live operation requires a relatively high level of proficiency for the operator, and insulation protection measures are required.
- (3) When installing the transformer, foreign matter such as impurities and dust must not fall into the cutting surface of the iron core, so as not to affect the performance of the transformer.
- (4) If the ShineSEM-X is not equipped with an ammeter, no current transformer needs to be installed.

4. Voltage sampling interface

Connect the voltage sampling line as shown in Figure 2-7. According to the three-phase four-wire wiring method, L1/L2/L3/N must be connected, otherwise the ShineSEM-X will not work properly.

5. Network cable interface

Pull a network cable from a router with a network, and plug it directly into the ring network switch of the communication box of the smart subarray. This interface is used for remote monitoring. For details, please refer to Chapter 5.

6. Ground terminal

To ensure the reliable operation and personal safety of the ShineSEM-X, the ground terminal on the housing must be reliably grounded.

Note: Pay attention to the waterproofing of the ground terminal.

2.6 PLC application system diagram

2.6.1 Single-stage PLC monitoring system

In field application wiring, the ShineSEM-X supports PLC communication, and can be used with multiple inverters for data collection, monitoring, uploading and other functions. The specific wiring diagram is as follows:

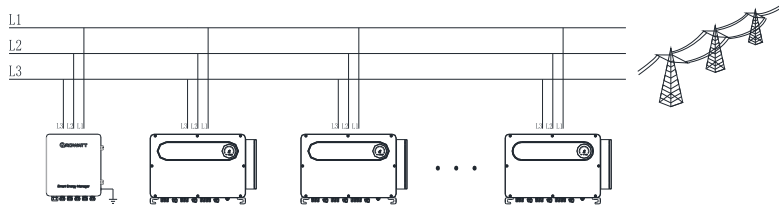

Figure 2-14 Schematic diagram of PLC communication connection

1. Overall wiring

As can be seen from the above figure, the ShineSEM-X is connected to L1, L2, and L3 of the power grid, and then each inverter is also connected to the power grid in sequence, and the data is uploaded to the cloud server through PLC communication monitoring.

Precautions:

- (1) If the on-site primary busbar is a cable, professional electrical personnel can carry out live installation; if the primary busbar is a copper bar, the live operation requires a relatively high level of proficiency for the operator, and requires good insulation protection measures.
- (2) When the ShineSEM-X is connected to the power grid, it is necessary to ensure that the three-phase L1, L2, and L3 of the power grid are connected to the L1, L2, and L3 phases of the ShineSEM-X in sequence.

2.6.2 Multi-level PLC monitoring system

If there are multiple inverters, a multi-level PLC monitoring system can be formed with the combiner box. The specific system connection block diagram is as follows:

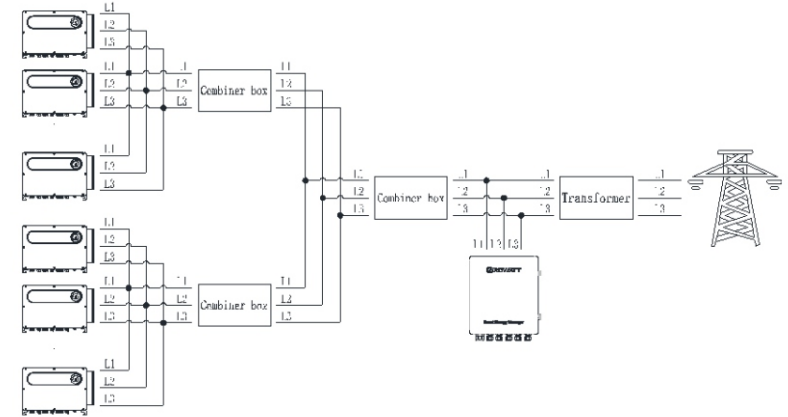

Figure 2-15 PLC cascade system diagram

1. Overall wiring

As can be seen from the cascading method in the above figure, multiple inverters are connected to the first-level combiner box, then connected to the second-level combiner box, and then connected to the power grid through the transformer. The ShineSEM-X must be installed on the transformer Before.

Precautions:

- (1) If the on-site primary busbar is a cable, professional electrical personnel can carry out live installation; if the primary busbar is a copper bar, the live operation requires a relatively high level of proficiency for the operator, and requires good insulation protection measures.
- (2) When the ShineSEM-X is connected to the power grid, it is necessary to ensure that the three-phase L1, L2, and L3 of the power grid are connected to the L1, L2, and L3 phases of the ShineSEM-X in sequence.
- (3) The location where the ShineSEM-X is connected must be before the transformer.

2.7 Ring Network Wiring

The ShineSEM-X supports ring network communication, enabling data collection and centralised uploading from multiple ShineSEM-Xs which can be uploaded to the monitoring system or local server. The ring network mode and wiring mode are as follows:

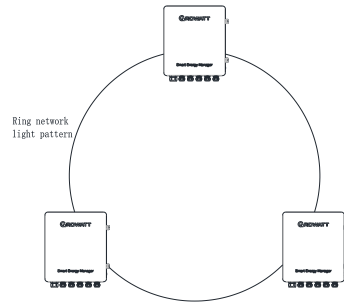

Figure 2-16 Schematic diagram of ring network

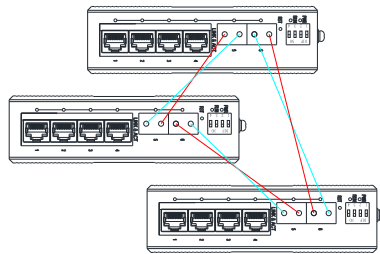

Figure 2-17 Schematic diagram of ring network switch connection

As we can see from the figure that the ring network communication can be realized between multiple communication boxes. The wiring method is through optical fiber, and the ring network switches in multiple communication boxes are connected in the way of cross wiring in the figure.

2.8 Cable Specifications

Cable location	Wire cross-sectional area (mm ²)	
	Scope	Recommended value
RS485 wiring	1~2.5 (16~14AWG)	1 (16AWG)
Current Transformer Wiring	1~2.5 (16~14AWG)	2.5 (14AWG)
Voltage Sampling Wiring	1~2.5 (16~14AWG)	2.5 (14AWG)
Ground wire	2.5~4 (14~12AWG)	4 (12AWG)

3.1 ShineMaster-X operation introduction

3.1.1 Access ShineMaster-X built-in page

You can access the built-in page of ShineMaster - X through static IP or dynamic IP to set or modify parameters of ShineMaster-X.

3.1.1.1 Direct connection with computer Access ShineMaster - X built-in page (static IP)

Connect PC and ShineMaster - X directly through network cable. The computer IP is changed to 192.168.0.XXX (XXX ranges from 2 to 253). The default IP of ShineMaster - X is: 192.168.0.254, enter 192.168.0.254 on the computer browser to visit the built-in page of ShineMaster - X. The computer IP setting can refer to the figure below:

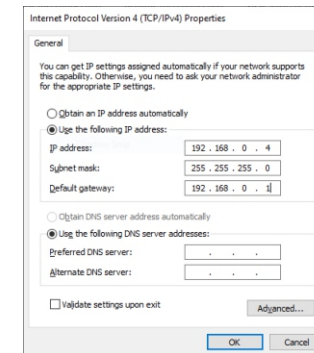

Figure 3-1 Schematic diagram of static IP setting

Note: The address of the DNS server does not need to be set.

3.1.1.2 Access ShineMaster-X built-in page through router (dynamic IP)

1. Connect the PC and ShineMaster-X to the same router so that they are in the same LAN. Note: The router must enable the DHCP function, and ShineMaster-X also needs to enable the DHCP function.

2. Check the IP field assigned by the router to the computer.

Enter ipconfig on the command line to view the IP field assigned by the router to the computer

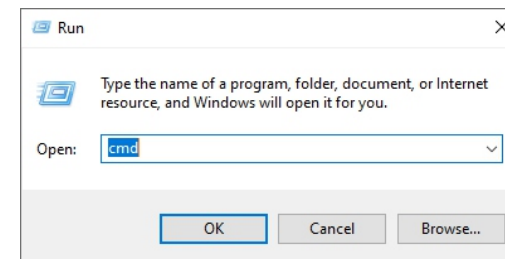

Figure 3-2 Schematic diagram of running window

```
C:\Users\sagel>ipconfig
```

Figure 3-3 Schematic diagram of command line input

```
Wireless LAN adapter Wi-Fi:

Connection-specific DNS Suffix . : home
Link-local IPv6 Address . . . . . : fe80::1ba3:8a3e:4f2f:52bd%3
IPv4 Address. . . . . : 192.168.1.74
Subnet Mask . . . . . : 255.255.255.0
Default Gateway . . . . . : 192.168.1.254
```

Figure 3-4 Schematic diagram of the results of the ipconfig command

3. Enter 192.168.1.254 in the computer browser to access the built-in page of ShineMaster-X .

Figure 3-5 Schematic diagram of login IP

3.1.2 Login

1. After successfully accessing the built-in page of ShineMaster-X, the user needs to log in to modify or set parameters, as shown in the figure below:

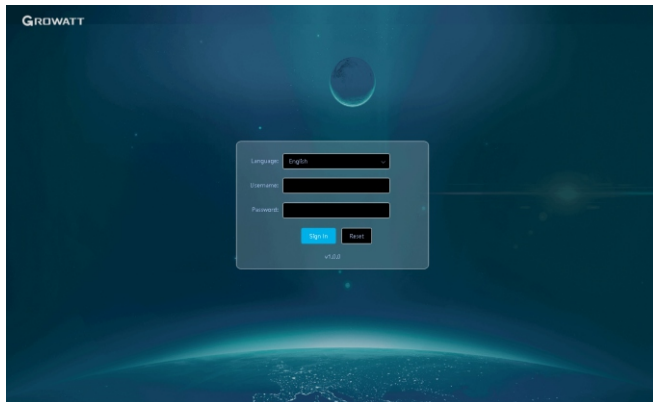

Figure 3-6 Login interface

2. Enter the user name and password, the default login user name: admin, password: admin, click login after filling in, enter the ShineMaster-X system page.

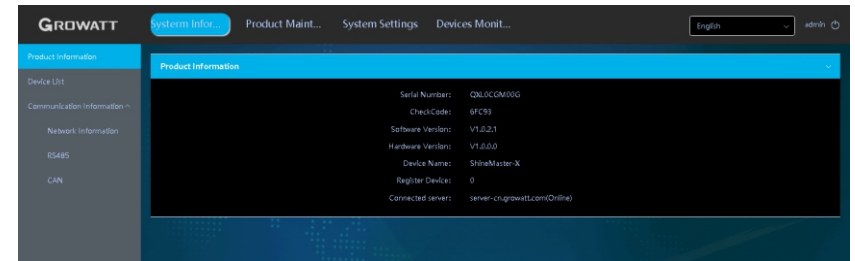

Figure 3-7 System information bar

3. The system page mainly includes the following four columns
A. System information, B. Product maintenance, C. System settings, D. Equipment monitoring.

3.1.3 ShineMaster-X data collector system information

- Click ShineMaster-X system information to view "product information", "device list", "communication information" and other information;

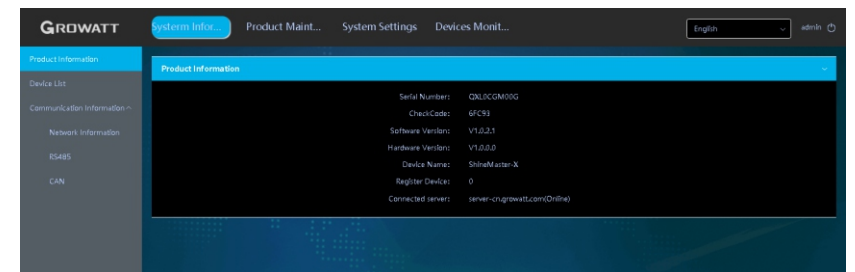

Figure 3-8 System information bar

Product information	ShineMaster-X serial number, software version and other information
Device List	Registered device information and online information
Internet Information	Details of wired and wireless networks
RS485	Setting information for RS485-1 , RS485-2 , RS485-3 , RS485-4
CAN	CAN communication information

3.1.4 ShineMaster-X collector settings

Log in to the built-in page, the login account is "admin", the password is "admin", select "Device Monitoring" in the first-level menu, select "Inverter" in the second-level menu, and select "Device Maintenance" in the third-level menu.

3.1.4.1 Add monitoring device

(1) Select the device to be added, "inverter", "electric meter", "environmental monitor" and "PID device". Here is an example of adding an inverter:

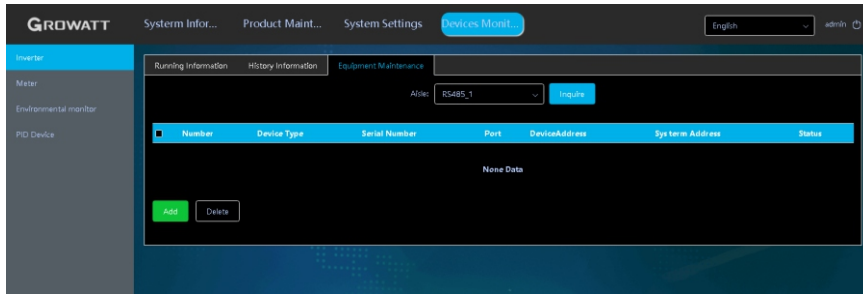

Figure 3-9 Inverter window

(2) Click "Add", and the "Add Data" window will pop up.

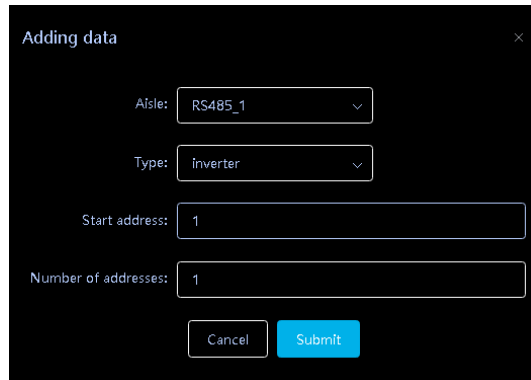

Figure 3-10 Add data window

(3) 485 channel where the device is located in the drop-down list of "Channel", there are four channels of RS 485-1, RS485-2, RS485-3 and RS485-4.

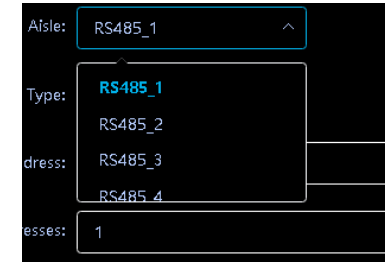

Figure 3-11 Channel selection

(4) Select the device type in the drop-down list of "Type".

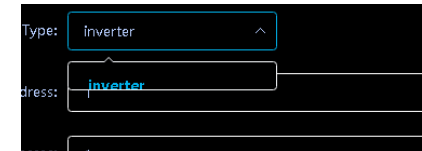

Figure 3-12 Device type selection

(5) "Start address" writes the start address of the added device, for example: suppose the address of the photovoltaic inverter to be monitored is "1", then the start address is 1.

Note: Only 32 devices can be added to each RS 485 channel, and the address of the photovoltaic device is 0-254;



Figure 3-13 Start address filling

(6) Number of addresses: ShineMaster supports adding multiple devices of the same type with consecutive addresses at one time. For example: Suppose there are four photovoltaic inverter addresses to be monitored, and the addresses are 1, 2, 3, and 4 respectively, then write "1" for "start address" and "4" for "number of addresses".

Note: There are only 32 devices that can be added to each RS 485 channel. Assuming that starting from address 1, only 32 devices can be added continuously at a time;



Figure 3-14 Add the number of addresses

(7) Then click Submit. After the prompt is successful, select "System Information" in the first-level menu, and select "Device List" in the second-level menu to check whether the inverter is added successfully.

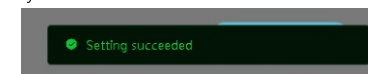

Figure 3-15 Add success prompt

Number	Device Type	Serial Number	Port	DeviceAddress	System Address	Status
1	Inverter		RS485_1	1	1	离线
2	Inverter		RS485_1	2	2	离线
3	Inverter		RS485_1	3	3	离线
4	Inverter		RS485_1	4	4	离线

Figure 3- 16 Device list

The device types are as follows:

Inverter	GROWATT Inverter
Electric meter	SDM one-way meter
	SDM three-way electric meter
	CHNT one-way meter
	CHNT three-way electric meter
	Ankerui Meter
	GRT meter
Environmental Monitor	Weather station
PID device	PID device

Note: Both SDM120 and SDM230 are one-way meters. If SDM230 is used on site, select SDM120 to add and OK when adding equipment.

3.1.4.2 Delete monitoring device

The deletion of equipment includes "inverter", "electric meter", "environmental monitoring instrument", and "PID equipment". The method of deleting devices is the same, taking the inverter as an example:

(1) Log in to the built-in page, the login account is "admin", the password is "admin", select "Device Monitoring" in the first-level menu, select "Inverter" in the second-level menu, and select "Device Maintenance" in the third-level menu.

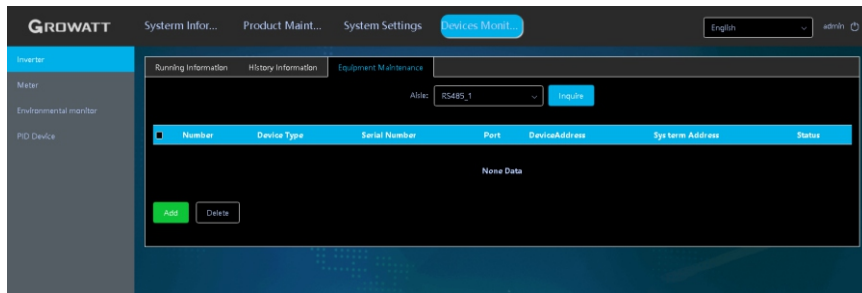

Figure 3- 17 Inverter window

(2) Select the RS 485 channel of the photovoltaic inverter in the "Channel" drop-down list, and then click "Query", and the photovoltaic equipment added under the RS 485 channel will be displayed;

Number	Device Type	Serial Number	Port	DeviceAddress	System Address	Status
1	Inverter		RS485_1	1	1	离线
2	Inverter		RS485_1	2	2	离线
3	Inverter		RS485_1	3	3	离线
4	Inverter		RS485_1	4	4	离线

Figure 3- 18 Device list

(3) Check the photovoltaic equipment that needs to be deleted, click "Delete", and click "Confirm";

Number	Device Type	Serial Number	Port	DeviceAddress	System Address	Status
1	Inverter		RS485_1	1	1	离线
2	Inverter		RS485_1	2	2	离线
3	Inverter		RS485_1	3	3	离线
4	Inverter		RS485_1	4	4	离线

Figure 3- 19 Schematic diagram of selected devices

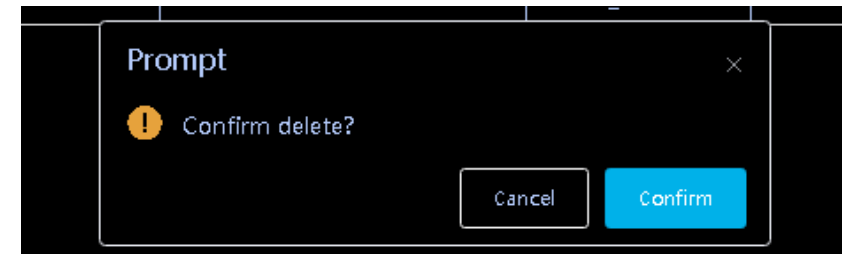

Figure 3- 20 Delete prompt

(4) After the prompt is successful, click "Query" again to check whether the deletion is successful;

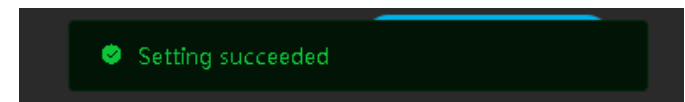

Figure 3- 21 Prompt for successful deletion

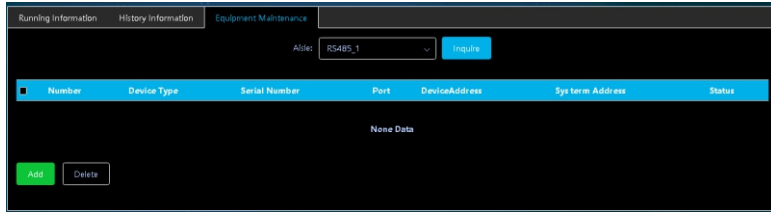

Figure 3- 22 Device list

3.1.5 ShineMaster-X network settings

When you need to use the remote monitoring function of ShineMaster-X, you need to set up its network. Under normal circumstances, the network parameters have been set before leaving the factory, and you can run according to the default configuration.

3.1.5.1 Collector network IP settings

(1) Check whether the ShineMaster-X has enabled the DHCP function, log in to the built-in page, the login account is "admin", the password is "admin", and select "Wired Communication" in the left list of "System Settings"

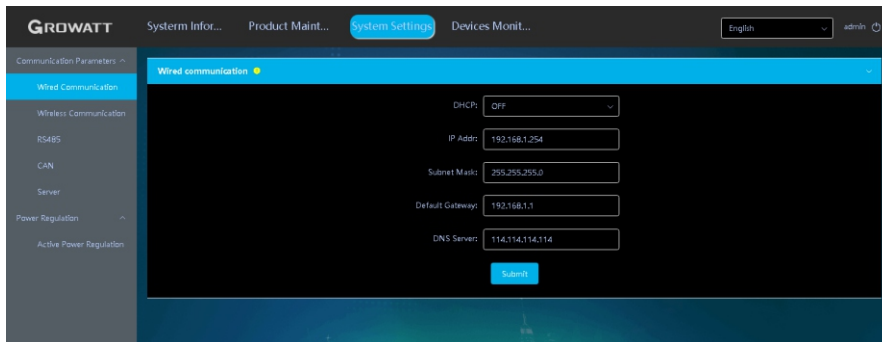

Figure 3- 23 Wired communication window

(2) The DHCP function is turned off by default at the factory , and the DHCP function needs to be turned on to automatically obtain an IP address from the router.



Figure 3- 24 DHCP enabled

(3) After the setting is successful, it needs to be restarted to take effect.

(4) If you need to set ShineMaster- X to a fixed IP during use, you need to perform the following settings: select "Wired Communication" in the left list of "System Settings", and turn off DHCP on the "Wired Communication" interface;

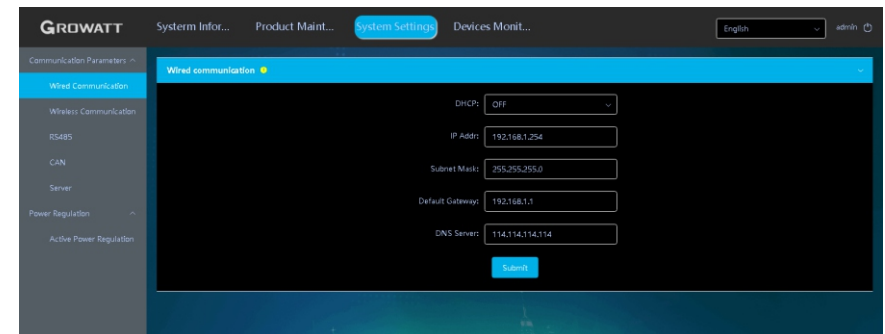

Figure 3- 25 Disable DHCP

Enter the user's own IP, gateway, subnet mask, DNS and other parameters, and click "Submit" . As shown below

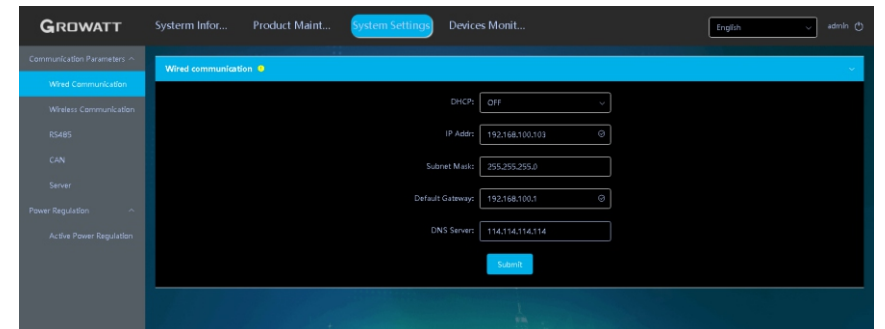

Figure 3- 26 Schematic diagram of manual IP configuration

After the setting is successful, a restart is required to take effect.

Specification parameters and model description 4

4.1 Specification parameters

3.1.5.2 Collector network IP settings

How to set the server address and domain name

(1) Login to the built-in page with the login account as "admin" and password as "admin", select "Server" in the left list of "System Settings", and select "Enable";

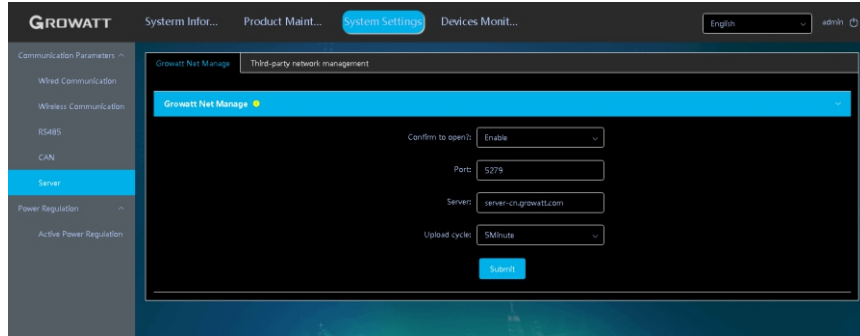

Figure 3- 27 Schematic diagram of server settings

(2) Enter the port number of the corresponding server, the domain name of the server, such as server-cn.growatt.com/server.growatt.com , and the time interval for data uploading, click Submit, and it will prompt to refresh the interface successfully to check whether the modification is successful.



Figure 3- 28 Prompt for successful server setup

(3) After the setting is successful, it needs to be restarted to take effect.

3.1.6 Precautions for operation on the configuration page

1. If the interface is not refreshed for a long time after clicking Save when adding a device, power off and restart the collector. After restarting, click "Device Status" to check whether the last operation was successful.
2. When configuring the parameters of the corresponding functions, only the parameters of the corresponding function should be configured as described above, other parameters not related to the desired configuration function remain unchanged.

ShineSEM-X (without electricity meter)	
Input voltage parameters	
Rated input voltage/range (three specifications)	400Vac 400~540Vac 800Vac
Rated input frequency/range	50/60Hz
Grid connection type	3W/N/PE
Communication Interface	
RS485	Have
Ethernet	Have
PLC	Optional
Ring switch	Optional
Maximum number of inverter connections	60PCS
Maximum communication distance	RS485 standard twisted pair shielded cable: 1000m Ethernet cable: 100m
General parameters	
Dimensions (height*width*thickness)	398*450*158 mm
Weight	13.5kg
Range of working temperature	-30°C - +60°C
Degree of protection	IP66
Relative humidity	5%-95%, no condensation
Placement	Indoor
Maximum working altitude	4000m
Terminal type	U-shaped terminal
Standards met	
Safety	CE,Rohs

ShineSEM-X (with electric meter)					
Technical Parameters					
Input voltage parameter					
Rated input voltage/range (three specifications)	400Vac 400~540Vac 800Vac				
Rated input frequency/range	50/60Hz				
Grid connection type	3W/N/PE				
Input current and CT parameters					
Maximum detection current (CT primary side current)	250A	600A	1200A	2000A	4000A
Input current (CT secondary side current)	5A				
Current Detection Accuracy (CT)	0.5				0.2
Communication Interface					
RS485	Have				
Ethernet	Have				
PLC	Optional				
Ring switch	Optional				
Maximum number of inverter connections	60PCS				
Maximum communication distance	RS485 standard twisted pair shielded wire: 1000m Ethernet cable: 100m				
General parameters					
Dimensions (height*width*thickness)	398*450*158 mm				
Weight	13.5kg				
Range of working temperature	-30°C - +60°C				
Degree of protection	IP66				
Relative humidity	5%-95%, no condensation				
Placement	Indoor				
Maximum working altitude	4000m				
Terminal type	U-shaped terminal				
Standards met					
Safety	CE、Rohs				
Note:	1. The total power of inverters or loads in the entire system cannot exceed the corresponding system capacity of the ShineSEM-X.				

4.2 Model description

The model introduction of the ShineSEM-X takes ShineSEM-X-RH as an example:

ShineSEM-X-RH

① ②③

logo	Meaning	Value
①	Product Identification	ShineSEM- X: Wisdom Subarray Communication Box
②	Functional ID	R: anti-reflux box C: communication box
③	Voltage level	L: 400V M: 480/540V H: 800V

Intelligent sub-array communication box, configuration barcode introduction:

Optional features	PLC: with PLC communication function SPF: with ring network communication function LTE: with 4G communication function EXT: With extended version, add 4 channels of 485 channels
Meter lines	3P4: The electric meter connection line adopts the three-wire four-phase system 3p3: The connection line of the electric meter adopts the three-wire three-phase system 2P3: The electric meter connection line adopts the split-phase connection method 1P2: The electric meter connection line adopts single-phase connection method
Current CT ratio	250/5A、600/5A、1200/5A、2000/5A、4000/5A、6000/5A

5 Contact us

Growatt New Energy provides customers with comprehensive technical support. Users can contact the nearest Growatt New Energy office or customer service point, or directly contact the company's customer service center.

Name: Shenzhen Growatt New Energy Co., Ltd.
Address: Building A, Zhongdeou Industrial Park,
Linghang Avenue, Baoan District, Shenzhen City,
Guangdong Province

Customer Service Hotline: 400-931-3122
E-mail: service@ginverter.com
Company website: www.growatt.com