



Installation Guide

Smart Energy Hot Water

Version 1.4

Disclaimers

Important Notice

Copyright © SolarEdge Inc. All rights reserved.

No part of this document may be reproduced, stored in a retrieval system or transmitted, in any form or by any means, electronic, mechanical, photographic, magnetic or otherwise, without the prior written permission of SolarEdge Inc.

The material furnished in this document is believed to be accurate and reliable. However, SolarEdge assumes no responsibility for the use of this material. SolarEdge reserves the right to make changes to the material at any time and without notice. You may refer to the SolarEdge web site (www.solaredge.com) for the most updated version.

All company and brand products and service names are trademarks or registered trademarks of their respective holders.

Patent marking notice: see <http://www.solaredge.com/patent>

The general terms and conditions of delivery of SolarEdge shall apply.

The content of these documents is continually reviewed and amended, where necessary. However, discrepancies cannot be excluded. No guarantee is made for the completeness of these documents.

The images contained in this document are for illustrative purposes only and may vary depending on product models.

Emission Compliance

This equipment has been tested and found to comply with the limits applied by the local regulations.

These limits are designed to provide reasonable protection against harmful interference in a residential installation. This equipment generates, uses and can radiate radio frequency energy and, if not installed and used in accordance with the instructions, may cause harmful interference to radio communications. However, there is no guarantee that interference will not occur in a particular installation. If this equipment does cause harmful interference to radio or television reception, which can be determined by turning the equipment off and on, you are encouraged to try to correct the interference by one or more of the following measures:

- Reorient or relocate the receiving antenna.
- Increase the separation between the equipment and the receiver.

- Connect the equipment into an outlet on a circuit different from that to which the receiver is connected.
- Consult the dealer or an experienced radio/TV technician for help.

Changes or modifications not expressly approved by the party responsible for compliance may void the user's authority to operate the equipment.

Contents

Disclaimers	1
Important Notice	1
Emission Compliance	1
HANDLING AND SAFETY INSTRUCTIONS	4
Safety Symbols Information	4
Smart Energy Hot Water Installation	5
Overview	5
Smart Energy Hot Water Interfaces	9
Installing the Device	12
Connection	14
Configuration	19
Configuration with Inverters with an LCD	19
Configuration with Inverters with SetApp	23
Modifying the Device Operation Mode and Schedules	24
Verifying the Connection	24
Troubleshooting Errors	26
Support Contact Information	29

Revision History

- Version 1.4, November 2019 - Editorial changes
- Version 1.3, November 2019 - Updated Configuration with Inverters with SetApp.
- Version 1.2, November 2019 - Added reference to the temperature sensor installation guide.
- Version 1.1, May 2019 - Editorial changes
- Version 1.0, March 2019 - Initial release

HANDLING AND SAFETY INSTRUCTIONS

During installation, testing and inspection, adherence to all the handling and safety instructions is mandatory. **Failure to do so may result in injury or loss of life and damage to the equipment.**

Safety Symbols Information

The following safety symbols are used in this document. Familiarize yourself with the symbols and their meaning before installing or operating the system.

WARNING!



Denotes a hazard. It calls attention to a procedure that, if not correctly performed or adhered to, could result in **injury or loss of life**. Do not proceed beyond a warning note until the indicated conditions are fully understood and met.

CAUTION!



Denotes a hazard. It calls attention to a procedure that, if not correctly performed or adhered to, could result in **damage or destruction of the product**. Do not proceed beyond a caution sign until the indicated conditions are fully understood and met.

NOTE



Denotes additional information about the current subject.

IMPORTANT SAFETY FEATURE



Denotes information about safety issues.

Disposal requirements under the Waste Electrical and Electronic Equipment (WEEE) regulations:

NOTE



Discard this product according to local regulations or send it back to SolarEdge.

Smart Energy Hot Water Installation

Overview

The SolarEdge Smart Energy solutions allow increasing the self-consumption of a site. One method used for this purpose is controlling the usage (consumption) of loads using Smart Energy products.

The Smart Energy devices divert power to an appliance (load) according to pre-configured schedules, using the following modes:

- **Schedule** - The device turns on and off at times set by the user for the user's convenience, regardless of available PV power.
- **Smart Save** - The device (typically a boiler or water pump) is controlled automatically to maximize self-consumption. Grid power is used only if PV power is insufficient to meet the user's "Ready by" time. For example, to heat water for 2 hours and have hot water by 18:00, set the **Duration** to 2 hours and **Ready-by** to 18:00. The boiler may work before 16:00 if there is available PV power, but in any case you are guaranteed to have hot water by 18:00.

Refer to *Figure 2* for examples of the device modes of operation.

You can re-configure the schedules at any time and manually switch appliances on and off.

You can configure the Smart Energy products locally through the inverter, or remotely via the monitoring platform (or monitoring smartphone app).

The Smart Energy Hot Water (referred to as "the device" throughout) is a Smart Energy product that diverts excess energy produced by the PV system to a load, normally a hot water heater. The device saves energy and reduces utility bills by storing energy as hot water during the day when surplus energy is high, and providing free hot water later on in the day.

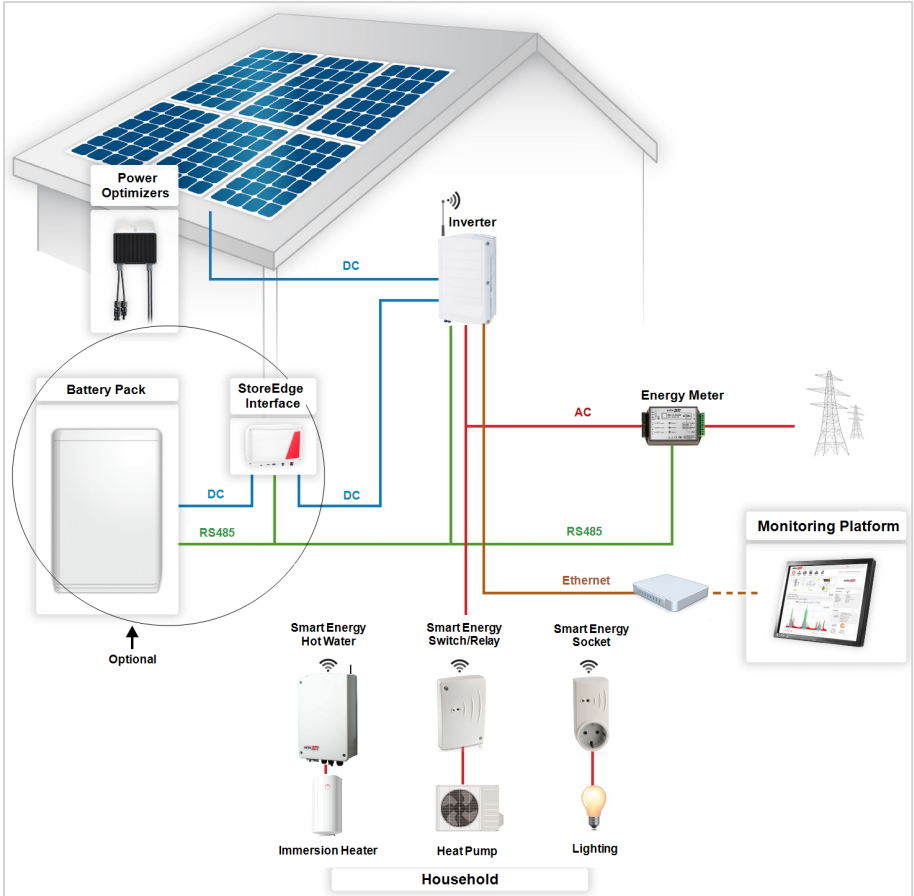

Figure 1: SolarEdge system with Smart Energy products

The following figure illustrates a typical example of device operation with Smart Save and Schedule modes. Note that in Smart Save mode, the consumption is reduced by taking advantage of excess PV earlier in the day.

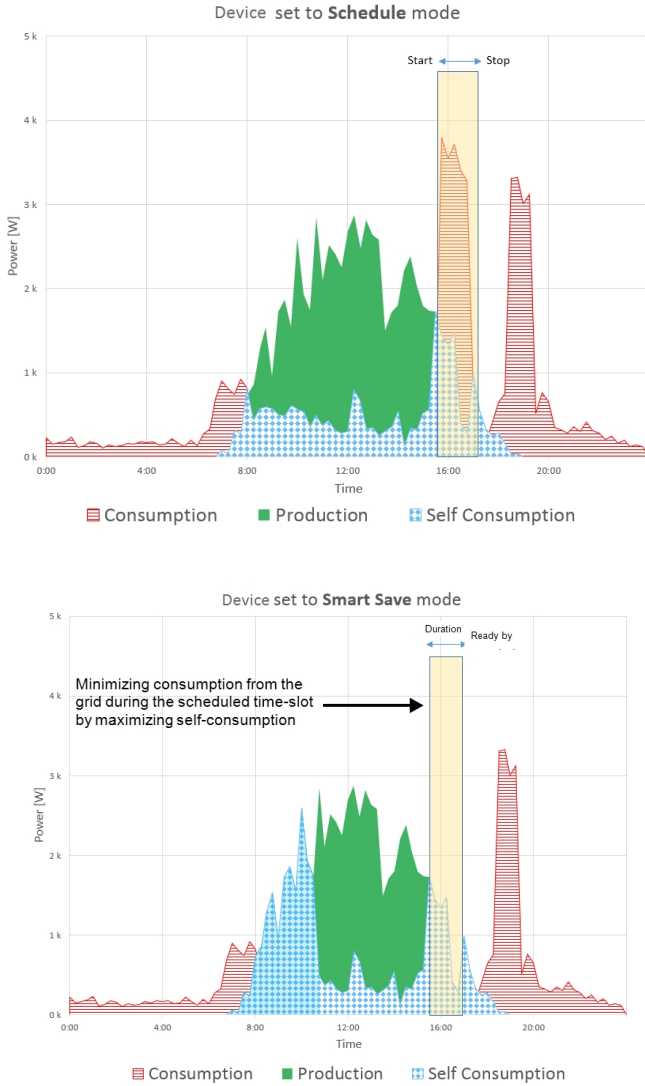

Figure 2: Examples of device operation

To enable the Smart Energy Hot Water functionality, the following supporting devices must be installed:

■ Energy Meter:

- Energy Meter with Modbus Connection. Refer to:
<http://www.solaredge.com/files/pdfs/solaredge-meter-installation-guide.pdf> or

<http://www.solaredge.com/files/pdfs/solaredge-meter-installation-guide-na.pdf>



- Energy Meter with Cellular Connection. Refer to
https://www.solaredge.com/sites/default/files/se_energy_meter_cellular_na.pdf



- ZigBee Plug-in for Smart Energy. Refer to:
<https://www.solaredge.com/sites/default/files/se-device-control-zigbee-module-installation-guide.pdf>



<https://www.solaredge.com/sites/default/files/se-zigbee-plug-in-for-setapp-installation-guide.pdf>



- Optionally, a temperature sensor may be used to display the water temperature (purchased separately).

A third party P100/1000 sensor may also be used.

For more information, refer to:

https://www.solaredge.com/sites/default/files/se_temperature_sensor_installation_guide.pdf



Smart Energy Hot Water Interfaces

The following figure shows the connectors and interfaces of the device.

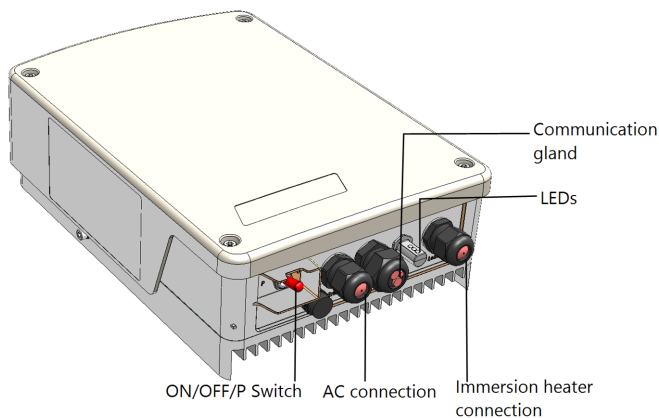

Figure 3: Device interfaces

- Cable connection glands**
- ON/OFF/P Switch** - manages the device operation.
 - ON (1)** - Turning this switch ON starts the operation of the device
 - OFF (0)** - Turning this switch OFF stops power supply to the immersion heater
 - P** - Moving and releasing the switch allows viewing system information via the LEDs and on the Inverter SetApp mobile application, and performing the following functions:

P Position duration	Function	Comments
Switch moved to P for less than 5 seconds	Boost Mode - the device delivers maximum power to operate the immersion heater in full capacity for one hour.	When the switch is released all LEDs turn OFF for 0.5 sec and then display the production or error indication.
Switch moved to P for less than 5 seconds, while in Boost Mode	The device stops power supply to immersion heater.	
Switch moved to P for 5-10 seconds	Starts pairing (association) of the device with the inverter. The inverter provisions, controls and connects the device to the monitoring platform. Re-associating the device loads the previous configuration so re-configure is not required.	Association is indicated by all LEDs blinking.
Switch moved to P for 30 seconds	Factory reset - disconnects the device from the inverter	After reset, association with the inverter is required.

➤ **LEDs** - The LED indicators provide information about the device operation status:

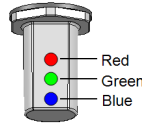

Figure 4: Three LED Indicators

Color	Indication	Description
Red	Fault	<p>Off - No error</p> <p>On – Error, or during Boot/Reset</p> <p>Blinking - During pairing with the inverter</p>
Green	Power delivery to immersion heater (load)	<p>Flickering⁽¹⁾ – No power is delivered to the immersion heater</p> <p>On - Delivering power to the immersion heater, or during Boot/Reset</p> <p>Blinking - During pairing with the inverter</p>
Blue	ZigBee/Wi-Fi Communication link to the inverter	<p>Off – Not paired with the inverter</p> <p>Blinking - The device is paired with the inverter however not connected to the monitoring platform, or during pairing with the inverter</p> <p>ON - The device is paired with the inverter and connected to the monitoring platform, or during Boot/Reset</p>
All LEDs		<p>Off - The device is not powered.</p> <p>On - During boot / reset</p> <p>Blinking (sequentially) - Device firmware upgrade</p> <p>Blinking (simultaneously) - During pairing with the inverter</p>

(1)Flickering: 100mS ON, 5Sec OFF

Installing the Device

**CAUTION!**

To avoid damage to electrical equipment, connect only purely resistive loads/appliances to the Smart Energy Hot Water.

CAUTION!

- This product must be operated under the specified operating specifications, as described in the latest technical specification data sheet.
 - This product must be used with immersion heaters that include a thermostat that shuts off the power when reaching the required temperature.
 - Configure the product so that the load connected is not switched on or off more frequently than specified by the load manufacturer.
- 
- Do not connect loads that require a continuous current supply (e.g. fridge, freezer).
 - Do not use the product if it is damaged or malfunctioning.
 - Never connect loads that can cause injuries or fire if they are switched on unintentionally (e.g. an iron).
 - Do not let the product come into contact with water or other liquids.
 - The enclosed documentation is an integral part of this product. Keep the documentation in a convenient place for future reference and observe all instructions contained therein.

NOTE

It is recommended to install a 2-pole magneto-thermal switch breaker between the AC cables coming from the mains and the AC cables going to the immersion heater.

Package Contents

- Smart Energy Hot Water device
- Mounting bracket kit with screws
- Two Ferrite beads
- Antenna kit
- This installation guide

Mounting the Device

NOTE



Make sure the mounting surface or structure can support the weight of the device.

1. Determine the device mounting location, on a wall, stud framing or pole. To allow access and enable proper heat dissipation, maintain a minimum clearance and a maximum distance from the inverter, as shown below:

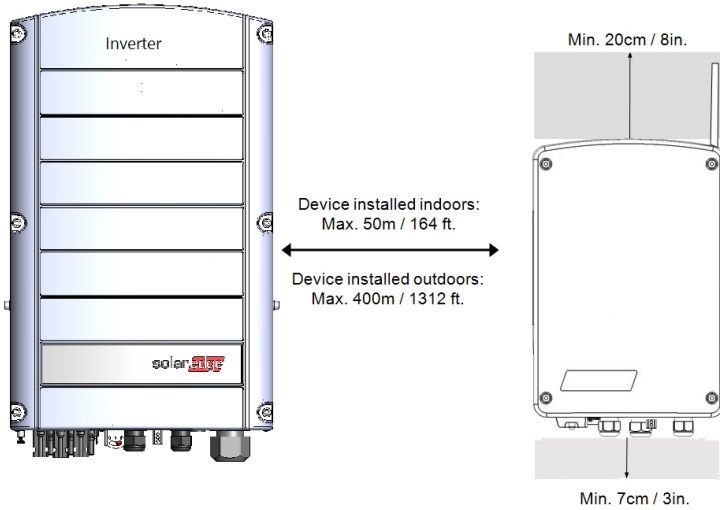

Figure 5: Clearance

2. Position the bracket against the wall/ pole, level the bracket and mark the drilling hole locations. Ensure that the U-shaped indentations of the bracket are facing up.

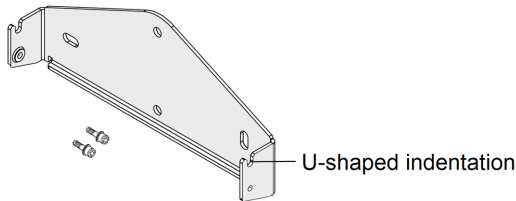

Figure 6: Mounting bracket kit

3. Drill the holes and mount the bracket. Verify that the bracket is firmly attached to the mounting surface.

4. Lift the device from the sides, or hold it at the top and bottom to lift the device into place.
5. Lower the device onto the U-shaped indentations (see *Figure 7*). Let the device lay flat against the wall or pole.
6. Insert the two supplied screws through the outer heat sink fin on both sides of the device and into the bracket. Tighten the screws with a torque of 4.0 N*m / 2.9 lb.*ft.

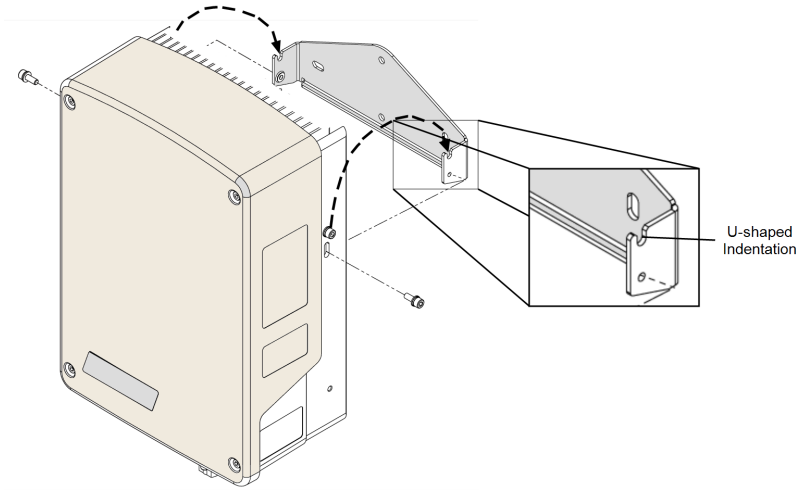

Figure 7: Hanging the device on the bracket

Connection

Guidelines

- Make sure that power is disconnected from the main distribution panel.
- Connect the device through a circuit breaker in the AC distribution panel.
- Connect the device through a 2-pole magneto-thermal switch breaker in the AC distribution panel.
- Use a 3-core cable with a minimum wire cross section of 2.5 mm².
- Use the connection gland suitable for the cable diameter (6 - 12 mm or 4 - 8mm).
- Use the following cable types for power supply:
 - Rubber sheathed, H05RR-F of type HD 22.4
 - PVC sheathed, H05W-F of type HD 21.5

NOTE

The electrical connections to grid and load may be different depending on device version. Therefore, pay attention to the connector labels when replacing the device for maintenance. Also, cable connections may require extension to fit the location of grid/ load terminal blocks.

Connecting the Device

1. Turn OFF the AC circuit breaker of the main distribution panel.
2. Release the four screws attaching the device cover to the enclosure and remove the cover.

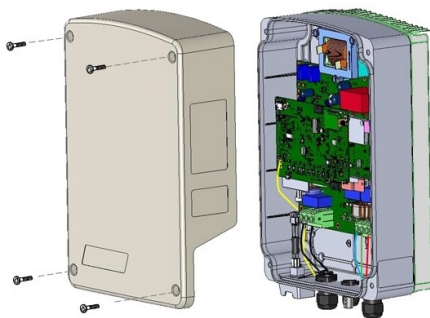

Figure 8: Opening the cover

CAUTION!

Do not connect the device *output* (labeled A & B) to the grid, as this will damage the product and void the warranty. Connect the AC grid cable to the designated *input* only (see *Figure 9*).

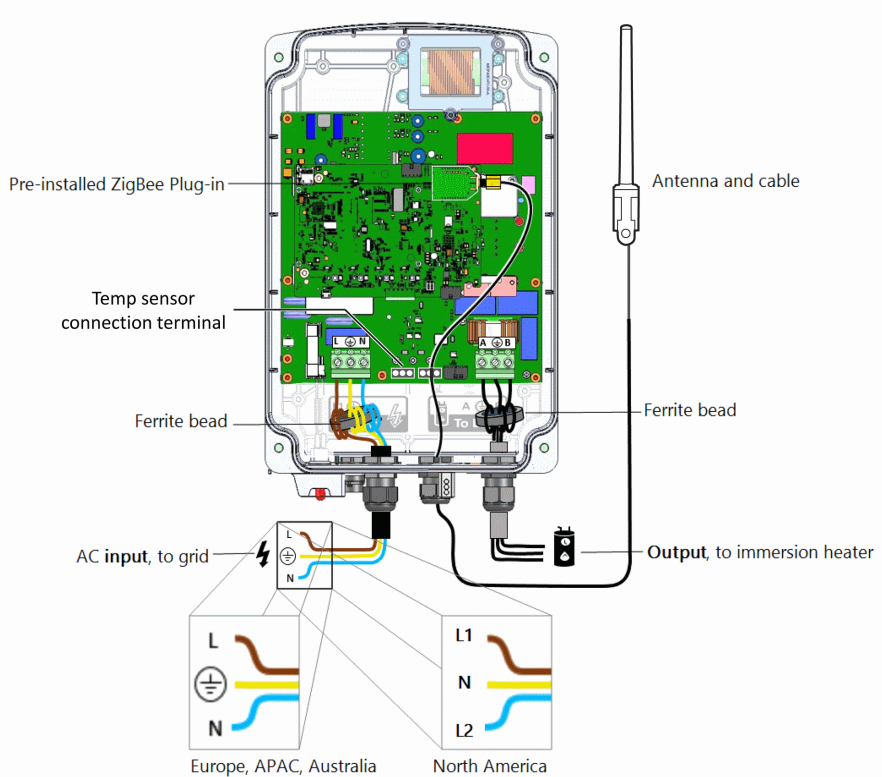

Figure 9: Smart Energy Hot Water wire connections

3. Connect AC (to the grid; see *Figure 9*):
 - a. Insert the AC cable coming from the mains through the **left-most** gland and one of the supplied Ferrite Bead.
 - b. Wrap the cable 2 wraps in the bead; wrap the grounding wire in the opposite direction to the other wires.
 - c. Connect the AC wires according to labels (L, \oplus , N) on the left terminal block.
4. Connect to the immersion heater (see *Figure 9*):

CAUTION!

Do not connect the device to an immersion heater that is not equipped with a safe-temperature sensor. You can use immersion heaters with mechanical thermostat only.

- a. Insert the cable from the immersion heater through the **right-most** gland and the second Ferrite bead.
 - b. Wrap the wires one wrap in the bead.
 - c. Connect the three wires according to labels (A, \oplus , B) on the right terminal block.
5. Connect the antenna:
- a. Unpack the antenna kit and release the cable binding.
 - b. Connect the antenna to the mounting clip.
 - c. Attach the mounting clip with the antenna vertically to the top of the heat sink fins.
 - d. Insert the antenna cable from the top of the device and route the cable downwards along and between the heat sink fins.

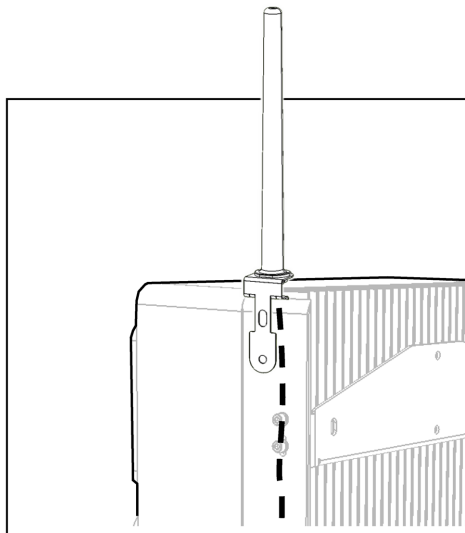

Figure 10: Mounting the Antenna

- e. Open the communication gland at the bottom of the device and insert the antenna cable through the sealing nut and the rubber seal. Use the cut opening to route the antenna cable through the rubber seal.

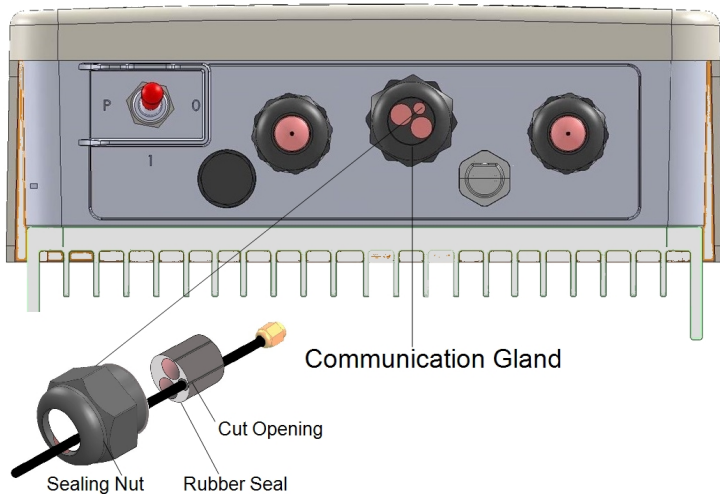

Figure 11: Communication gland

- f. Insert the rubber seal with the cable into the gland and tighten the sealing nut.
 - g. Fasten the connector of the antenna cable to the pre-installed ZigBee Plug-in (see *Figure 9*).
6. Close the device cover and fasten the screws.
 7. Turn ON the AC circuit breaker of the main distribution panel.
 8. Turn On the device by turning the ON/OFF/P switch to **1 (ON)** - all LEDs turn on for two seconds, then they flash quickly for two seconds.

Configuration

Smart Energy devices are configured using the following inverter types:

- Inverters with an LCD - from firmware version 3.25xx. Refer to *Configuration with Inverters with an LCD* on page 19.
- Inverters with SetApp configuration - from firmware version 4.7.xx. Refer to *Configuration with Inverters with an LCD* on page 19.

For detailed information about various use cases, refer to https://www.solaredge.com/sites/default/files/home_energy_management_immersion_heater_controller_use_cases_app_note.pdf.



NOTE



Verify that the inverter has a ZigBee Plug-in installed and is connected to the monitoring platform (refer to the *Inverter Installation Guide* for details on setting up communication).

Configuration with Inverters with an LCD

Required inverter Firmware CPU version : v3.25xx and later.

→ To associate the device with the inverter using the inverter LCD user buttons:

1. Enter the inverter Setup mode as described in the *Inverter Installation Guide*.
2. Select **Communication** → **ZigBee Conf.**.
3. Select:
 - **Device Type** → **HA** (Home Automation)
 - **Protocol** → **HAM** (Home Automation)

When HA Device Type is selected, a **Device Manager** menu item will appear in the main configuration menu:

```
Country <Italy>
Language <Eng>
Communication
Power Control
Display
Maintenance
Information
```

4. From the main menu select **Device Manager**. The Device Manager screen is displayed:

```
Add Devices < 0 >
```

5. Select **Add Devices** to start the device association with the inverter.
6. Hold the ON/OFF/P switch of the Smart Energy Hot Water device to the left for more than 5 seconds.

The Device Manager LCD screen should display a new line for each discovered device, including the 3 last digits of its serial number, operating mode and operating state. Discovery time may take up to 3 minutes. You can press the inverter LCD light button or the internal ESC button to exit the discovery process when all devices are discovered.

```
Add Devices < 3 >
SE-REG xxx < Auto, OFF >
SE-REG-36xx < Auto, OFF >
SE-SW xxx < Man, OFF >
SE-S-PLGxxx < Man OFF >
Remove All
```

Device types:

- **SE-SW** - Smart Energy Relay
- **SE-S-PLG** - Smart Energy Socket
- **SE-S-SW** - Smart Energy Switch

7. Select the device. The device configuration screen is displayed:

```
Mode < Manual >
State < OFF >
Device Info
Remove Device
```

For the following device configuration steps, you can use either the inverter LCD buttons or the monitoring platform/ app. The steps herein show configuration using the inverter LCD.

For configuring using the monitoring platform, refer to https://www.solaredge.com/sites/default/files/configuring_device_control_with_the_monitoring_app.pdf



8. Select **Mode**. The mode configuration screen is displayed:

```
Manual
Auto
```

- **Manual** - turns the device to ON or OFF, as described below
- **Auto** - allows setting two types of schedules for Home Energy Management, as described in the next sections:
 - **Smart Save** - set the device operation requirements (ReadyBy and Duration values). This mode is useful for maximizing self-consumption using excess PV power: the device operates autonomously based on configured settings.
 - **Schedule** - set the device start and stop times regardless of available excess PV power.

→ To set **Manual mode**:

1. Select **Mode** → **Manual**
2. Select **ON** or **OFF** to turn the device on or off.

→ To set **Auto mode**:

1. Select **Auto**. The following screen is displayed, showing options for setting the device parameters:

```
Mode <Auto>
Use Excess PV <Y>
Add Schedule
Device Properties
Device Info
Remove Device
```

2. Select **Device Properties** and set the following properties:

```
Load Rating <x.x KW>
Min On Time <xxx>
```

- **Load Rating** - the rated power (in kW) of the appliance (immersion heater)
- **Min ON Time** - (optional); the minimum duration (in minutes) the appliance should remain ON once switched on, even when no excess PV power is available. The default value is 5 minutes.

3. Select **Use Excess PV**. The following screen is displayed:

```
Set <Yes>
Week Days <1234567>
```

- **Set <Yes/ No>** - automatically divert the excess PV to the device (default: Yes).
- **Week Days <optional>** - days to repeat the settings (default: every day).

4. Select **Add Schedule**. The following screen is displayed, showing schedule setting options. You can configure up to four different schedules.

```
Smart Save
Schedule
Disable
Remove Schedule
```

Use **Disable** to deactivate a schedule or **Remove Schedule** to delete it.

5. Select and set one of the scheduling options:

■ **Smart Save:**

```
Set < Smart >
Ready by < 00:00 >
Duration < 00 >
```

- **Ready by** - requested energy must be diverted to the load by this time (default: 00:00; format: hours:minutes).
- **Duration** - minimum accumulated time the load must remain on (in minutes; default: 00).



NOTE

The actual accumulated time the load remains on may be longer due to diversion of excess PV energy.

■ **Schedule:**

```
Set < Schedule >
Start Time < 00:00 >
End Time < 00:00 >
Week Days < 1234567 >
```

- **Start/End Time** - the time of day by which the Smart Energy Hot Water must start/ complete its task of delivering energy to the load (default: 00:00; format: hours:minutes). If these values are not set, only the excess PV power is used.
- **Week Days** (optional) - days to repeat the settings (default: every day).

NOTE



In Auto mode, if you configure overlapping time-frames between Schedule and Smart Save options, Schedule mode takes precedence over the Smart Save mode.

Configuration with Inverters with SetApp

Required inverter Firmware CPU version : v4.7xx and later.

→ To associate the Smart Energy device with the inverter using SetApp:

1. Access SetApp as described in the *Inverter Installation Guide*.
2. Select **Commissioning** > **Communication** > **ZigBee** > **Protocol** > **Home Automation**.
3. Return to the **Commissioning** screen.
4. Select **Device Manager**. The **Smart Energy Manager** screen is displayed.
5. Select **Add Devices** to start device association with the inverter. A 3 minute countdown starts.
6. Within the 3-minute time, depending on your device type:
 - Move the ON/OFF/P switch to P position and hold for more than 5 seconds.
 - Press the association button for 2 seconds.SetApp indicates that the device has been associated.
7. After all required devices have been associated, tap **Stop** in the Smart Energy Manager to exit.

→ To configure the Smart Energy device:

1. Go to the monitoring platform web-site on your computer, or open the monitoring platform application on your mobile device.
2. Click/tap the **Smart Energy** icon.
3. Select a device and go to **Details and Settings**.
4. Complete the following information:
 - Rated power
 - Min active time
 - Device icon
 - Device name
5. Return to the device screen and configure:
 - Schedules
 - Ready-by timers
 - Excess Solar Power mode (requires a SolarEdge Energy Meter)
 - Device state

Modifying the Device Operation Mode and Schedules

You can re-configure the device operation mode and schedules at any time, using the monitoring platform.

To	Do this
Manually turn the load on or off	Select the device from the Device Manager screen. Select Mode → Manual and set the device to either ON or OFF .
Disconnect the device(s) from the network	Select Remove Device or Remove All from the device screen.
Modify the schedule configuration (only for inverters with an LCD)	Select the device from the Device Manager screen. Select Mode → Auto and set the parameters of any menu: Smart Save/Schedule .
Disable or delete a schedule (only for inverters with an LCD)	Select Disable or Remove Schedule from the Schedule screen.

Verifying the Connection

Inverters with LCD

1. Check the status screens:

- *HA devices status*, showing the device name and state: ON, OFF, or an asterisk (*), which indicates no communication with the device:

```
HA Devices Status:
REG 011 <ON>
```

- *Communication status*, showing the number of communicating HA devices (under Prot) and the number of detected devices (under ##):

```
      Dev  Prot  ##
RS485-1 <---> <---> <-->
ZigBee  <HA>  < 1> < 1>
```

2. To check the device details, from the device configuration screen, select **Device Info**. The following screen is displayed:

```
MAC: xxxxxxxxxxxx
Last seen: <DD:HH>
MFG: SolarEdge
Power [W]: 0
Pos Energy[W]: 4
```

- **MAC:** the full MAC address of the device
- **Last seen:** The date and time when the device communicated with the inverter
- **MFG:** The device manufacturer
- **Model:** The device model type
- **Power [W]:** The energy delivered to the load
- **Pos Energy[W]:** The energy imported from the grid (if applicable)

Inverters with SetApp Configuration

1. Go to **Device Manager > Device Info**.
2. Check that the following device details are correct:
 - **MAC Address:** the full MAC address of the device
 - **Last Communication:** The date and time when the device communicated with the inverter
 - **MFG:** The device manufacturer
 - **Model:** The device model type
 - **Power [W]:** The energy delivered to the load
 - **Positive Energy[Wh]:** The energy imported from the grid (if applicable)
 - **Negative Energy[Wh]:** The energy exported from the grid (if applicable)

Troubleshooting Errors

Depending on your inverter type, the following error messages may be displayed either on the inverter's LCD or in the SetApp application.

Symptom / Error	Possible Cause	Troubleshooting
<ul style="list-style-type: none"> • LCD inverters - An asterisk (*) is displayed next to the Device type in the Device Manager screen indicating that the device is not communicating. • SetApp inverters - a Not connected error message is displayed. • In the Communication status screen, the number of detected devices does not match the number of communicating devices. • The device is powered on but the blue LED is OFF. 	The device is not associated with the inverter	<p>Try to solve using these options. If problem is not solved, proceed with the next option:</p> <ul style="list-style-type: none"> • Turn the device OFF and ON. Recheck communication. • Turn the device OFF and then repeat the association process. Reconfiguration is not required. • From the Device Manager screen select Remove Device and repeat the discovery process. Reconfiguration is required in this case. • Contact SolarEdge support.
The device is powered on and the green LED is flashing.	Error is detected.	
All the devices are not communicating	<p>No ZigBee error is displayed on the inverter LCD - The inverter has not detected the installed ZigBee Plug-in.</p>	<ul style="list-style-type: none"> • Turn OFF the AC to the inverter • Check that the ZigBee Plug-in is inserted correctly inside the inverter. • Turn ON the AC to the inverter
	Network problems	Try to solve using these options. If

Symptom / Error	Possible Cause	Troubleshooting
		<p>problem is not solved, proceed with the next option:</p> <ul style="list-style-type: none"> • Check the ZigBee status screen: Verify that PAN has been established and Channel is not 0 <div data-bbox="677 408 1011 533" style="border: 1px solid #ccc; padding: 5px; margin: 10px 0;"> <pre>PAN:XXXXXX CH:XX/XXXXRSSI:<L> MID:XXXXXX</pre> </div> <ul style="list-style-type: none"> • Turn the inverter OFF and ON (power cycle). • Reset all the devices using the association button and begin the discovery process again for all devices. • From the Device Manager screen select Remove All and repeat the discovery process for all the devices. • Contact SolarEdge support.
<p>No hot water.</p>	<p>The device is associated with the inverter (blue LED is on) but not delivering power to the load.</p>	<p>Try to solve using these options. If problem is not solved, proceed with the next option:</p> <ul style="list-style-type: none"> • Check that the circuit breaker is ON and if there is an ON/OFF manual switch in series with the Smart Energy Hot Water it should be turned ON. • Check the configured schedules to verify device should in fact deliver power. • Check that the load is connected properly. • Turn the device OFF and ON. recheck communication.

Symptom / Error	Possible Cause	Troubleshooting
		<ul style="list-style-type: none"> • Turn the device OFF and ON and then repeat the discovery process. Reconfiguration is not required. • From the Device Manager screen select Remove Device and repeat the discovery process. Reconfiguration is required in this case. • Contact SolarEdge support.
<p>Error message Device limit reached. Remove devices from the device list is displayed in the LCD.</p>	<p>You are attempting to associate more than 10 devices to the load management network.</p>	<p>Remove an unused device from the device list before attempting to add another device.</p>
<p>The device is not functioning</p>		<ol style="list-style-type: none"> 1. Turn the inverter ON/OFF/P switch to OFF. Wait 5 minutes for the capacitors to discharge. 2. Disconnect the AC to the system by turning OFF the main circuit breakers on the distribution panel. <div style="background-color: #cccccc; padding: 5px; text-align: center; margin: 10px 0;">WARNING!</div> <div style="text-align: center; margin: 10px 0;">  <p>ELECTRICAL SHOCK HAZARD. Do not touch uninsulated wires when the device cover is removed.</p> </div> <ol style="list-style-type: none"> 3. Open the device screws and remove the cover. 4. Check that all the wires are correctly and firmly connected. 5. Return the cover and fasten the screws.

Support Contact Information

If you have technical problems concerning SolarEdge products, please contact us:



<https://www.solaredge.com/service/support>

Before contact, make sure to have the following information at hand:

- Model and serial number of the product in question.
- The error indicated on the product SetApp mobile application LCD screen or on the monitoring platform or by the LEDs, if there is such an indication.
- System configuration information, including the type and number of modules connected and the number and length of strings.
- The communication method to the SolarEdge server, if the site is connected.
- The product's software version as it appears in the ID status screen.



Smart Energy Hot Water Specifications (North America)

ELECTRICAL SERVICE		
Operating Voltage Range	210 - 273	Vac
AC Frequency	60	Hz
Nominal Voltage	240	Vac
Supported Grids	L1 /L2/N/PE or L1/L2/PE	
Maximum Supported Load Size	4.5	kW
Maximum Load Current Rating	19	A
Minimum Output Power	5% of load rating	
Load Type	Resistive	
Efficiency	> 98	%
Input Over-voltage Protection ⁽¹⁾	273	Vac
Output Over-current Protection	22	A
External Over-current Protective Device Rating	≥ 25	A
Type of Action	Type 1 C	
COMMUNICATION		
Supported Communication Protocol	ZigBee Home Automation	
Device Configuration	Via the inverter LCD, the monitoring platform/ app, or SetApp; Ethernet connection is required	
Nominal Transmit Power	22.8	dBm
EIRP with Antenna	27.8	dBm
Maximum Emitted Power	≤ 30	dBm
Bandwidth	2	MHz
Modulation	O-QPSK with DSSS coding	
Operating Frequency Range	2.4 - 2.5	GHz
Outdoor (LOS) Range	400 / 1312	m / ft.
Indoor Range ⁽²⁾	50 / 164	m/ ft.

(1)The device stops diverting power to the load when this threshold is exceeded

(2)Approximate values. May differ depending on specific installation conditions.

STANDARD COMPLIANCE		
Safety	UL 60730; CSA C22.2	
Emissions	FCC part 15 class B	
Radio	ETSI EN 300 328 V 1.8.1; ETSI EN 301 489-1; ETSI EN 301 489-17	
INSTALLATION SPECIFICATIONS		
Dimensions (H x W x D)	375 x 240 x 110 / 14.7 x 9.5 x 4.5	mm/ in
Weight	5.3 / 11.7	kg/ lb
Operating Temperature Range	-10 to +50 / 14 to 122	°C / °F
Conduits	Support of 1/2 and 3/4 inch conduits (8-gauge wire) Pre-drilled opening of 1.109 in.	
Terminal Block Minimum Wire Cross Section	15 / 1.5	AWG/mm ²
Maximum distance between Device and Load/ Cable cross section - for load size 3.0kW	3/10 for 13 AWG/2.5 mm ² 20/65 for 11 AWG/ 4 mm ²	m/ft
Protection Rating	NEMA3R	
Mounting Type	Wall mount	

Mechanical specifications (mm):

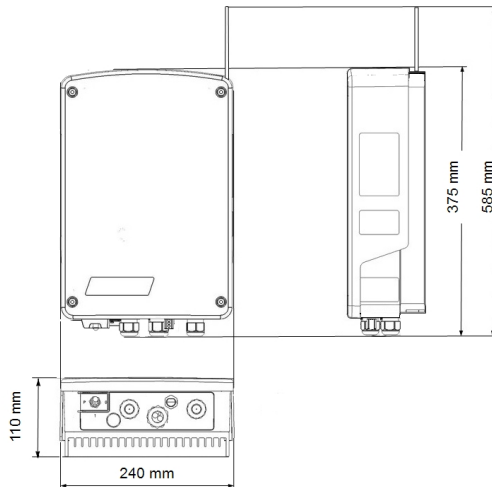



Smart Energy Hot Water Specifications (Europe & APAC)

ELECTRICAL SERVICE		
Operating Voltage Range	205 - 264	Vac
AC Frequency	50	Hz
Nominal Voltage	230	Vac
Supported Grids	L/ N/ PE	
Maximum Supported Load Size	3.0	kW
Maximum Load Current Rating	13	A
Minimum Output Power	5% of load rating	
Load Type	Resistive	
Efficiency	> 98	%
Input Over-voltage Protection ⁽¹⁾	264	Vac
Output Over-current Protection	22	A
External Over-current Protective Device Rating	≥ 20	A
Type of Action	Type 1 C	
COMMUNICATION		
Supported Communication Protocol	ZigBee Home Automation	
Device Configuration	Via the inverter LCD, the monitoring platform/ app, or SetApp; Ethernet connection is required	
Nominal Transmit Power	11.8	dBm
EIRP with Antenna	16.8	dBm
Maximum Emitted Power	≤ 20	dBm
Bandwidth	2	MHz
Modulation	O-QPSK with DSSS coding	
Operating Frequency Range	2.4 - 2.5	GHz
Outdoor (LOS) Range	400 / 1312	m / ft.
Indoor Range ⁽²⁾	50 / 164	m/ ft.

(1)The device stops diverting power to the load when this threshold is exceeded

(2)Approximate values. May differ depending on specific installation conditions.

STANDARD COMPLIANCE		
Safety	IEC-60730 -1	
Emissions	EN61000-6-1,2,3; EN61000-4-2,3,4,5,6,8,11; EMC directive 2014/30/EU	
Radio	ETSI EN 300 328 V 1.8.1; ETSI EN 301 489-1; ETSI EN 301 489-17	
INSTALLATION SPECIFICATIONS		
Dimensions (H x W x D)	375 x 240 x 110 / 14.7 x 9.5 x 4.5	mm/ in
Weight	5.3 / 11.7	kg/ lb
Operating Temperature Range	-10 to +50 / 14 to 122	°C / °F
Cable Gland Diameters	2 glands 6-12, 1 gland 4-8	mm
Terminal Block Minimum Wire Cross Section	15 / 1.5	AWG/mm ²
Maximum distance between Device and Load/ Cable cross section - for load size 3.0kW	3/10 for 15 AWG/1.5 mm ² 20/65 for 13 AWG/ 2.5 mm ²	m/ft
Protection Rating	IP65	
Mounting Type	Wall mount	

Mechanical specifications (mm):

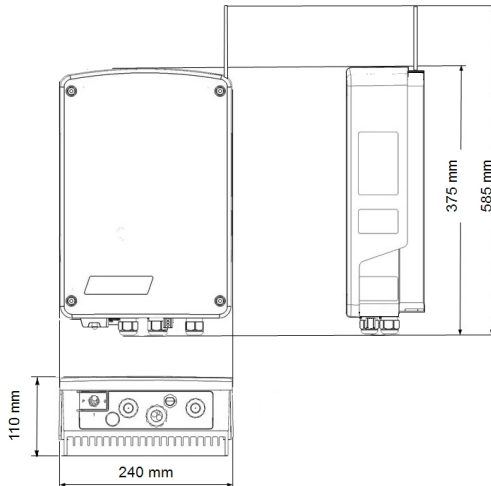



Smart Energy Hot Water Specifications (Australia)

ELECTRICAL SERVICE		
Operating Voltage Range	207 - 264	Vac
AC Frequency	50	Hz
Nominal Voltage	230	Vac
Supported Grids	L/ N/ PE	
Maximum Supported Load Size	4.8	kW
Maximum Load Current Rating	21	A
Minimum Output Power	5% of load rating	
Load Type	Resistive	
Efficiency	> 98	%
Input Over-voltage Protection ⁽¹⁾	264	Vac
Output Over-current Protection	22	A
External Over-current Protective Device Rating	≥ 25	A
Type of Action	Type 1 C	
Over Voltage Category ⁽²⁾	III	
COMMUNICATION		
Supported Communication Protocol	ZigBee Home Automation	
Device Configuration	Via the inverter LCD, the monitoring platform/ app, or SetApp; Ethernet connection is required	
Nominal Transmit Power	11.8	dBm
EIRP with Antenna	16.8	dBm
Maximum Emitted Power	≤ 20	dBm
Bandwidth	2	MHz
Modulation	O-QPSK with DSSS coding	
Operating Frequency Range	2.4 - 2.5	GHz
Outdoor (LOS) Range	400 / 1312	m / ft.

(1)The device stops diverting power to the load when this threshold is exceeded

(2)Working voltage of 300 Vac.

Indoor Range ⁽¹⁾	50 / 164	m/ ft.
STANDARD COMPLIANCE		
Safety	IEC-60730 -1	
Emissions	EN61000-6-1,2,3; EN61000-4-2,3,4,5,6,8,11	
Radio	ETSI EN 300 328 V 1.8.1; ETSI EN 301 489-1; ETSI EN 301 489-17	
INSTALLATION SPECIFICATIONS		
Dimensions (H x W x D)	375 x 240 x 110 / 14.7 x 9.5 x 4.5	mm/ in
Weight	5.3 / 11.7	kg/ lb
Operating Temperature Range	-10 to +50 / 14 to 122	°C / °F
Conduits	Pre-drilled openings of 25 mm for 2 conduits.	
Terminal Block Minimum Wire Cross Section	15 / 1.5	AWG/mm ²
Maximum distance between Device and Load/ Cable cross section - for load size 3.0kW	3/10 for 13 AWG/2.5 mm ² 20/65 for 11 AWG/ 4 mm ²	m/ft
Protection Rating	IP65	
Pollution Degree	3	
Mounting Type	Wall mount	

Mechanical specifications (mm):

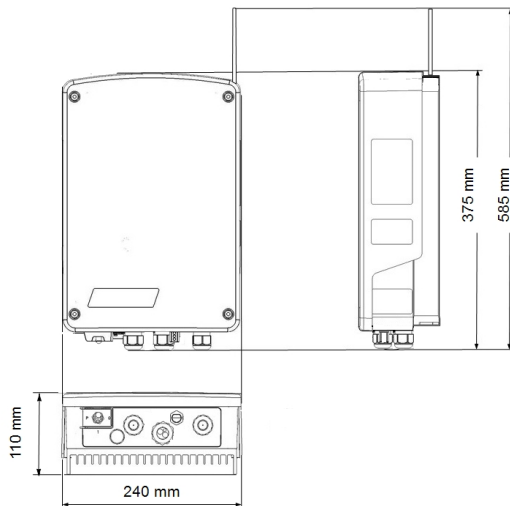

(1) Approximate values. May differ depending on specific installation conditions.

solaredge