

Air conditioner

User manual

AR60FC1*** / AR70F**C1*****

- Thank you for purchasing this Samsung air conditioner.
- Before operating this unit, please read this manual carefully and retain it for future reference.

Contents

Safety Information	4
Safety Information	4
At a Glance	15
Indoor Unit Overview	15
Display	16
Remote Control Overview	17
Charging the remote control	18
Remote Control Operation	19
Initial Settings	19
Selecting an operation mode • To set the temperature	20
To adjust the fan speed • To adjust the airflow direction	21
Smart Features	22
Power Smart Features	22
WindFree Cooling function	22
Dry Comfort function	23
AI Auto mode	24
AI Energy mode	25
Cool mode	26
Dry mode • Fan mode	27
Heat mode • Automatic defrost	28
Variety Smart Features	29
MAX function	29
Eco function	30
Quiet function • Beep function	31
Auto Clean function	32
Freeze Wash function	34
Display lighting function • Wi-Fi function (SmartThings app)	35
Time scheduling	36
Timed on/ Timed off function	36
Good Sleep function	38

Cleaning and Maintenance	39
Schedule	39
Cleaning	40
Appendix	44
Troubleshooting	44
Information about Refrigerant	46
SmartThings app	47
Reference	49



***Correct Disposal of This Product
(Waste Electrical & Electronic Equipment)***

(Applicable in countries with separate collection systems)

This marking on the product, accessories or literature indicates that the product and its electronic accessories (e.g. charger, headset, USB cable) should not be disposed of with other household waste at the end of their working life. To prevent possible harm to the environment or human health from uncontrolled waste disposal, please separate these items from other types of waste and recycle them responsibly to promote the sustainable reuse of material resources.

Household users should contact either the retailer where they purchased this product, or their local government office, for details of where and how they can take these items for environmentally safe recycling.

Business users should contact their supplier and check the terms and conditions of the purchase contract. This product and its electronic accessories should not be mixed with other commercial wastes for disposal.



Correct disposal of batteries in this product

This marking on the battery, manual or packaging indicates that the batteries in this product should not be disposed of with other household waste at the end of their working life. Where marked, the chemical symbols Hg, Cd or Pb indicate that the battery contains mercury, cadmium or lead above the reference levels in EC Directive 2006/66.

For information on Samsung's environmental commitments and product regulatory obligations, e.g. REACH, visit our sustainability page available via www.samsung.com

Safety Information

WARNING: Read This Manual

Read and follow all safety information and instructions before installation, use, or maintenance of this appliance. Incorrect installation, use, or maintenance of this appliance can result in death, serious injury, or property damage. Keep these instructions with this appliance. This manual is subject to change. For the latest version, visit www.samsung.com.

Because the instructions in this manual cover various models, the characteristics of your air conditioner may differ slightly from those described. If you have any questions, please contact your service provider or visit www.samsung.com.

Notices and notes

To make you aware of safety messages and highlighted information, we use the following notices and notes throughout this manual:

WARNING

Hazards or unsafe practices that may result in severe personal injury or death.

CAUTION





Hazards or unsafe practices that may result in minor personal injury or property damage.

IMPORTANT

Information of special interest

NOTE

Supplementary information that may be useful

Symbol	Meaning
A2L 	WARNING: Low burning velocity material (This appliance is filled with R-32.)
	The user and installer guides should be read carefully.
	The user and installer guides should be read carefully.
	The service guide should be read carefully.

FOR GENERAL

This appliance is not intended for use by persons (including children) with reduced physical, sensory or mental capabilities, or lack of experience and knowledge, unless they have been given supervision or instruction concerning use of the appliance by a person responsible for their safety. Children should be supervised to ensure that they do not play with the appliance.

For use in Europe : This appliance can be used by children aged from 8 years and above and persons with reduced physical, sensory or mental capabilities or lack of experience and knowledge if they have been given supervision or instruction concerning use of the appliance in a safe way and understand the hazards involved. Children shall not play with the appliance. Cleaning and user maintenance shall not be made by children without supervision.

Safety Information

IMPORTANT

To perform its antimicrobial function this product has been treated with the biocide substance Silver zinc zeolite.

FOR INSTALLATION

WARNING

Use a power cord with this product's power specifications or higher and use the power cord for this appliance only. In addition, do not use an extension cord.

- Extending the power cord may result in electric shock or fire.
- Do not use an electric transformer. This may result in electric shock or fire.
- If the voltage/frequency/rated current condition is different, it may cause fire.

The installation of this appliance must be performed by a qualified technician or service company. Do not attempt to install the air conditioner yourself.

- Failing to do so may result in electric shock, fire, explosion, problems with the product, or injury and may also void warranty on the installed product.

Install an Isolation Switch next to the Air Conditioner (but not on the panels of the Air Conditioner) and circuit breaker dedicated to the air conditioner.

- Failing to do so may result in electric shock or fire.

Fix the outdoor unit firmly so that the electric part of the outdoor unit is not exposed.

- Failing to do so may result in electric shock, fire, explosion, or problems with the product.

Do not install this appliance near a heater, or flammable material. Do not install this appliance in a humid, oily or dusty location, in a location exposed to direct sunlight and water (or rain). Do not install this appliance in a location where gas may leak.

- This may result in electric shock or fire.

Never install the outdoor unit in a location such as on a high external wall where it could fall.

- If the outdoor unit falls, it may result in injury, death or property damage.

This appliance must be properly grounded. Do not ground the appliance to a gas pipe, plastic, water pipe, or telephone line.

- Failing to do so may result in electric shock, fire, and explosion.
- Make sure to use a socket-outlet with ground.

The product shall be stored in a room with no ignition sources (e.g. open flames, gas appliance, electric heater, etc.).

- Note that the refrigerant has no odour.



CAUTION

Please cover the air conditioner with PE BAG after installation, and remove it when you start to run air conditioner.

Install your appliance on a level and hard floor that can support its weight.

- Failing to do so may result in abnormal vibrations, noise, or problems with the product.

Install the drain hose properly so that water drains correctly.

- Failing to do so may result in water overflowing and property damage. Avoid adding drain to waste pipes as odours may arise in the future.

Safety Information

When installing the outdoor unit, make sure to connect the drain hose so that draining is performed correctly.

- The water generated during heating by the outdoor unit may overflow and result in property damage. In particular, in winter, if a block of ice falls, it may result in injury, death or property damage.

Do not install the product in a place where thermo-hygrostat is needed (such as server room, machinery room, computer room, etc.)

- Those places do not provide guaranteed operation condition of the product therefore performance can be poor in these places.

FOR POWER SUPPLY



WARNING

When the circuit breaker is damaged, contact your nearest service centre.

Do not pull or excessively bend the power line. Do not twist or tie the power line. Do not hook the power line over a metal object, place a heavy object on the power line, insert the power line between objects, or push the power line into the space behind the appliance.

- This may result in electric shock or fire.

If the supply cord is damaged, it must be replaced by the manufacturer, its service agent or similarly qualified persons in order to avoid a hazard.

CAUTION

When not using the air conditioner for a long period of time or during a thunder/lightning storm, cut the power at the circuit breaker.

- Failing to do so may result in electric shock or fire.

FOR USING

WARNING

If the appliance is flooded, please contact your nearest service centre.

- Failing to do so may result in electric shock or fire.

If the appliance generates a strange noise, a burning smell or smoke, cut off the power supply immediately and contact the nearest service centre.

- Failing to do so may result in electric shock or fire.

If the air conditioner malfunctions or requires repair, immediately stop its operation and disconnect the entire power system. Then consult the authorized service personnel.

In the event of a gas leak (such as propane gas, LP gas, etc.), ventilate immediately without touching the power line. Do not touch the appliance or power line.

- Do not use a ventilating fan.
- A spark may result in an explosion or fire.

Safety Information

To reinstall the air conditioner, please contact your nearest service centre.

- Failing to do so may result in problems with the product, water leakage, electric shock, or fire.
- Delivery service for the product is not provided. If you reinstall the product in another location, additional construction expenses and an installation fee will be charged.
- Especially, when you wish to install the product in an unusual location such as in an industrial area or near the seaside where it is exposed to salt in the air, please contact your nearest service centre.

Do not touch the circuit breaker with wet hands.

- This may result in electric shock.

Do not turn the air conditioner off with the circuit breaker while it is operating.

- Turning the air conditioner off and then on again with the circuit breaker may cause a spark and result in electric shock or fire.

After unpacking the air conditioner, keep all packaging materials well out of the reach of children, as packaging materials can be dangerous to children.

- If a child places a bag over its head, it may result in suffocation.

Do not touch the airflow blade with your hands or fingers during heating.

- This may result in electric shock or burns.

Do not insert your fingers or foreign substances into the air inlet/outlet of the air conditioner.

- Take special care that children do not injure themselves by inserting their fingers into the product.

Do not strike or pull the air conditioner with excessive force.

- This may result in fire, injury, or problems with the product.

Do not place an object near the outdoor unit that allows children to climb onto the machine.

- This may result in children seriously injuring themselves.

Do not use this air conditioner for long periods of time in badly ventilated locations or near infirm people.

- Since this may be dangerous due to a lack of oxygen, open a window at least once an hour.

Do not use means to accelerate the defrost operation or to clean, other than those recommended by Samsung.

Do not pierce or burn.

Be aware that refrigerants may not contain an odour.

If any foreign substance such as water has entered the appliance, cut off the power supply and contact the nearest service centre.

- Failing to do so may result in electric shock or fire.

Do not attempt to repair, disassemble, or modify the appliance yourself.

- Do not use any fuse (such as copper, steel wire, etc.) other than the standard fuse.
- Failing to do so may result in electric shock, fire, problems with the product, or injury.



CAUTION

Do not place objects or devices under the indoor unit.

- Water dripping from the indoor unit may result in fire or property damage.

Safety Information

Check that the installation frame of the outdoor unit is not broken at least once a year.

- Failing to do so may result in injury, death or property damage.

To prevent personal injury, make sure that you change the directions of the horizontal airflow blades after stopping the movements of the vertical airflow blade. (In case of adjusting the horizontal airflow manually)

When the air conditioner does not operate properly for cooling or heating, there is a possibility of refrigerant leakage. If any leakage, stop operation, ventilate the room, and consult your dealer immediately for recharging refrigerant.

The refrigerant is not harmful. However, if it comes in contact with fire, it may generate harmful gases and there is risk of fire.

During transportation of the indoor unit, the pipe lines shall be covered with brackets for protection. Do not move the product with holding the pipe lines.

- It may cause gas leakage.

Do not install the product in a ship or a vehicle (such as a campervan).

- Salt, vibration or other environmental factor may cause the product malfunction, electric shock or fire.

Do not stand on top of the appliance or place objects (such as laundry, lighted candles, lighted cigarettes, dishes, chemicals, metal objects, etc.) on the appliance.

- This may result in electric shock, fire, problems with the product, or injury.

Do not operate the appliance with wet hands.

- This may result in electric shock.

Do not spray volatile material such as insecticide onto the surface of the appliance.

- As well as being harmful to humans, it may also result in electric shock, fire or problems with the product.

Do not drink the water from the air conditioner.

- The water may be harmful to humans.

Do not hit, shake, drop, or attempt to disassemble the remote control.

When replacing the remote control batteries, keep them out of the reach of infants.

- If an infant eats batteries, contact a doctor immediately.

When replacing the remote control batteries, be careful not to get the battery fluid on your skin.

- Battery fluid is harmful to humans.

Do not touch the pipes connected with the product.

- This may result in burns or injury.

Do not cut or burn the refrigerant container or pipings.

Do not point the air direction to the fireplace or heater.

Do not use this air conditioner to preserve precision equipment, food, animals, plants or cosmetics, or for any other unusual purposes.

- This may result in property damage.

Avoid directly exposing humans, animals or plants to the airflow from the air conditioner for long periods of time.

- This may result in harm to humans, animals or plants.

Safety Information

FOR CLEANING

WARNING

Do not clean the appliance by spraying water directly onto it. Do not use benzene, thinner or alcohol to clean the appliance.

- This may result in discolouration, deformation, damage, electric shock or fire.

Before cleaning, servicing, or performing maintenance, make sure to disconnect the product from its power source and wait until the fan stops.

- Failing to do so may result in electric shock or fire.

CAUTION

Take care when cleaning the surface of the heat exchanger of the outdoor unit since it has sharp edges.

- This should be done by a qualified technician. Please contact your installer or service centre.

Do not clean the inside of the air conditioner by yourself.

- For cleaning inside the appliance, contact your nearest service centre.
- When cleaning the filter, refer to the descriptions in the 'Cleaning' section.
- Failing to do so may result in damage, electric shock or fire.
- Make sure to prevent any injury from sharp edges of the surface when handling the heat exchanger.

Indoor Unit Overview

The appearance of the actual product may differ slightly from the image below.

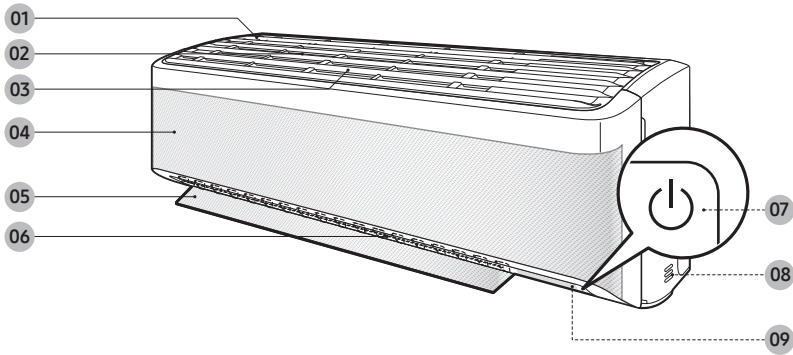

- 01 Air intake
- 02 Air filter
- 03 Tri-care filter (For AR70F**C1*** models)
- 04 WindFree panel
- 05 Airflow blade (up and down)

- 06 Airflow blade (left and right)
- 07 Power button/Remote control receiver
- 08 Room temperature sensor
- 09 Display

 **NOTE**

- The product ships with two Tri-care filters and the manual included.

Indoor Unit Overview

Display

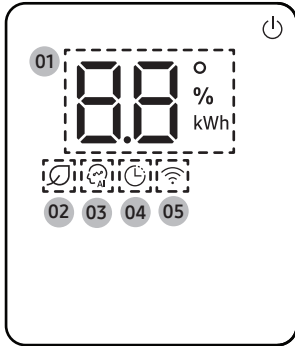

- 01 Temperature indicator (numeric) /
Filter reset indicator (F) /
Auto Clean indicator (AC) /
Defrost indicator (DF)
- 02 AI Energy indicator
- 03 AI Auto indicator
- 04 Timer indicator /
Good Sleep indicator
- 05 Wi-Fi indicator

NOTE

- When the Wi-Fi is turned on, the indicator blinks three times and then turns on.

NOTE

- If the Wi-Fi indicator blinks for 10 seconds when operation starts, it means that the air conditioner is not connected to Wi-Fi. See "SmartThings app" on page 47 and connect the air conditioner to Wi-Fi.
- When connected to Wi-Fi, the air conditioner can gather and learn your user patterns so that it can run in AI Auto mode.

Remote Control Overview

Most operating instructions in this manual require using the remote control.

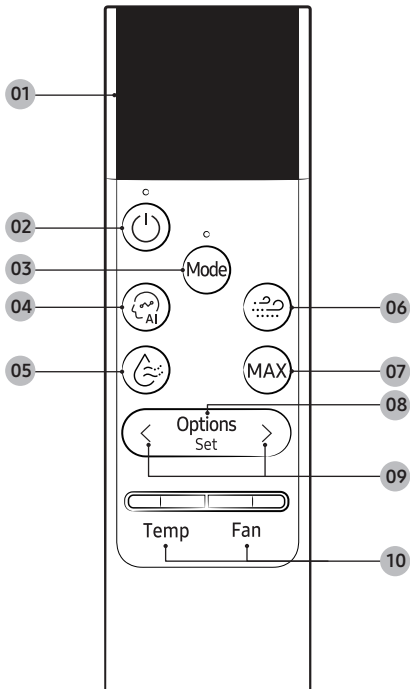

- 01 Display
- 02 Power button
- 03 Mode button
- 04 AI Auto button
- 05 Dry Comfort button
 - The Dry Comfort function is not available for the multi system. But, if you press this button, the device operates in Dry mode.
- 06 WindFree button
- 07 MAX button
- 08 Options/Set/Auto Clean button
 - Press and hold the button for 3 seconds to turn on or off the Auto Clean function.
- 09 Direction button
- 10 Temperature/Fan speed button
 - Push the button up or down to adjust the temperature or fan speed.
 - To set the airflow direction to Horizontal All or Horizontal Fix, press the **[Temp]** button.
 - To set the airflow direction to Vertical All or Vertical Fix, press the **[Fan]** button.

NOTE

- Press any button to wake up the display.
- The display switches off if no remote control button is pressed for 5 seconds.
- Although **Motion detection** appear on the remote control display, they are not available on this model.
- Low Ambient mode does not work on air conditioners, even if it is enabled under the Heating Range.
- The grey circles on the remote control buttons shown in the user manual indicate the regions that should be pressed for the buttons to work.

E.g. 

Remote Control Overview

Charging the remote control

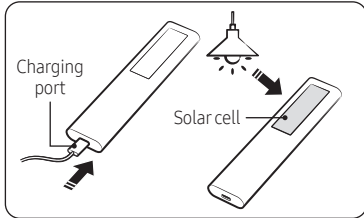

- Fully charge the remote control before use.
- If "Low battery" appears on the remote control display, charge the remote control by using the USB port (C-Type) at the bottom of the remote control. If you keep the remote control facing down, it is charged via the solar cell, allowing the battery to last longer.
- While the remote control is being charged, 'Charging' is displayed on the display. After charging is complete, 'Complete' appears and then the display turns off. Then, remove the charging cable.
- If the remote control will not be used for an extended period of time, make sure to charge the remote control by using the USB port before storage.

NOTE

- The product does not come with a remote control charging cable or charger.

Remote Control Operation

You can use the air conditioner easily by selecting a mode and then by controlling the temperature, fan speed, and air direction.

Initial Settings

Before using the remote control for the first time, you should set the temperature unit to Celsius or Fahrenheit.

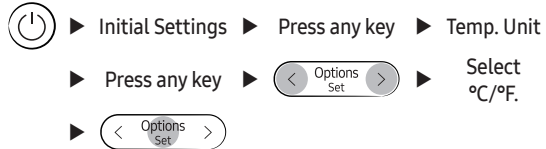

NOTE

- After the temperature unit is set, the remote control turns off. Press the button to turn it on.
- The temperature indications on the indoor unit are not switched.
- To change the temperature unit, change the setting as follows:

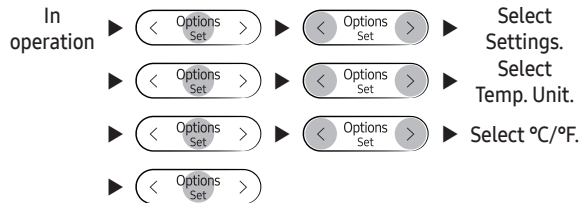

Remote Control Operation

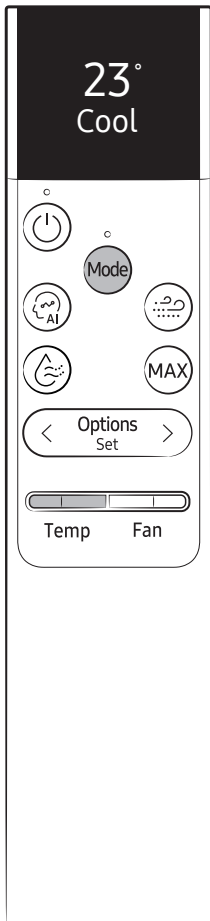

Selecting an operation mode

To change the current mode between AI Auto, Cool, Dry, Fan, and Heat, press the **(Mode)** (Mode) button.

You can use AI Auto mode after Wi-Fi is connected.

NOTE

- You can use the Cool, Dry, and Heat modes in the following operation range.

Mode	Cool	Dry	Heat
Indoor temperature	16 °C to 32 °C	18 °C to 32 °C	27 °C or less
Outdoor temperature	-10 °C to 46 °C	-10 °C to 46 °C	-15 °C to 24 °C ¹⁾
Indoor humidity	Relative humidity of 80 % or less ²⁾	-	-

¹⁾ If the outdoor temperature drops to -15 °C, the heating capacity may decrease by as much as 60-70 %.

²⁾ If the air conditioner operates in Cool mode in a high-humidity environment for an extended period of time, condensation may occur.

- For more information about outdoor temperature in the multi system, refer to the manual for the multi system.

To set the temperature





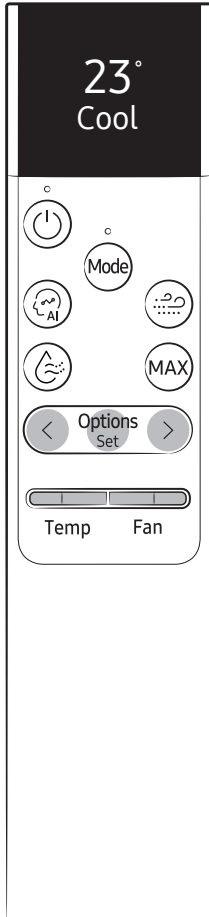









To control the temperature in each mode, Push the **[Temp]** button up or down:

Mode	Temperature control
AI Auto/Cool/Heat	Adjust by 1 °C from 16 °C to 30 °C.
Dry	Adjust by 1 °C from 18 °C to 30 °C.
Fan	No temperature control.





To adjust the fan speed

Select from the following fan speeds in each mode:

Mode	Available fan speeds
AI Auto	No fan speed control. (Auto fan, default controller setting)      (Manual fan)
Cool/Heat	    
Fan	   
Dry	No fan speed control.





To adjust the airflow direction

Keep the airflow in a constant direction by stopping the movements of the vertical and horizontal airflow blades.

- In operation ► Press  button ► Select Horizontal All or Horizontal Fix.
- or
- In operation ► Press  button ► Select Vertical All or Vertical Fix.

NOTE

- If you adjust the vertical airflow blade manually, it may not close completely when you turn off the air conditioner.
- Always use the remote control to adjust the airflow blades. Do not move the blades by hand. They may not operate normally.
- You cannot control the vertical airflow direction in Cool mode when the Good Sleep function is on.
- You can also select the airflow direction from the Options menu:

- In operation ►  ►  ► Select Direction. ►
- Select Vertical. ►  ► Select Vertical All or Vertical Fix.
- or
- Select Horizontal. ►  ► Select Horizontal All or Horizontal Fix.

Power Smart Features

Wind
Free
On

Wind
Free
Off

WindFree Cooling function

Use the WindFree Cooling function to enjoy a mild breeze coming through fine holes in the WindFree panel instead of air coming directly through the airflow blades.

In Cool/Dry/Fan mode ► 

NOTE

- To cancel this function, press the  (WindFree) button again.
- When the WindFree Cooling function is on, the air conditioner automatically controls the fan speed to keep your room mild and comfortable.
- When the WindFree Cooling function is canceled, the air conditioner returns to the original fan speed and air comes out of the airflow blades.
- In Cool mode, the recommended set temperature during the WindFree Cooling operation is 24 °C to 26 °C.
- You can use the WindFree Cooling function in Cool, Dry, or Fan mode.
- You cannot select the Quiet function during the WindFree Cooling operation.
- Selecting the WindFree Cooling function cancels the Dry Comfort, MAX, Eco, and airflow direction adjustment functions.

Dry
Comfort
On

Dry
Comfort
Off

Dry Comfort function

This dehumidification feature maintains comfortable humidity levels and saves energy by adjusting humidity according to the set temperature.

In operation ► 

NOTE

- The set temperature can be adjusted by 1 °C within the range of 18 °C to 30 °C.
- The fan speed is automatically adjusted.
- The airflow direction is automatically adjusted.
If the Dry Comfort feature is in use and you select Horizontal or Vertical, the feature turns off.
- If the Dry Comfort feature is in use and the indoor temperature and humidity is high, the airflow blade opens to adjust the temperature and humidity. The airflow blade automatically closes when the temperature and humidity becomes comfortable level.

Change of the airflow blade by temperature and humidity

Indoor temperature and humidity	If temperature and humidity is low <ul style="list-style-type: none">• Air blows from the WindFree panel	If temperature and humidity is high <ul style="list-style-type: none">• Air blows from the airflow blade
Airflow blade	Closed	Open

- For the multi system, the device operates in Dry mode.

Power Smart Features



AI Auto mode

Use AI Auto mode to automatically operate any of Cool, Dry, Heat, and WindFree Cooling modes depending on the learned user patterns gathered from an external server via Wi-Fi module. The favourite temperature and operation mode are also set based on the current temperatures (indoor/outdoor) and the gathered user patterns.





or



Select Auto.

NOTE

- You can use this mode after Wi-Fi is connected.
- In AI Auto mode, the  (AI Auto) and  (Wi-Fi) indicators appears on the display of the indoor unit.
- If the gathered user patterns are not sufficient, the set temperature is set based on the user's activity time and indoor/outdoor temperatures.
- The set temperature is controlled within the range of 22 °C to 28 °C (Cool) / 20 °C to 28 °C (Heat) in AI Auto mode. You can also change it manually.
- An automatically changed set temperature is shown on the indoor unit display, which switches to the current temperature after 4 to 5 seconds.
- When you press  (Mode) in AI Auto mode, the mode is cancelled.
- If you change the set temperature in AI Auto mode, the air conditioner operates with the changed set temperature.
- Adjust the fan speed or fix it at your desired speed. It can be done as follows:

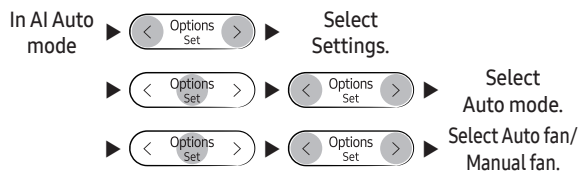

- If you select Auto Fan, the fan speed is automatically adjusted.
- If you select Manual Fan, you can choose a fan speed from Auto, Low, Med, High, and Turbo.

If not connected to Wi-Fi

- The air conditioner automatically switches to Cool, Dry, or Heat mode, depending on the temperature and humidity of the room. Optimum mode, appropriate for the current air quality of the room, operates automatically to quickly provide pleasant air.
- Fan speed is automatically adjusted, depending on the temperature and humidity of the room.

AI Energy mode

- Use AI Energy mode to save electricity consumed by the operating air conditioner. This mode can be turned on or off from the SmartThings app only.
- The amount of saved electricity is calculated while in AI Auto mode only.
- AI Energy indicator () lights up on the display of the indoor unit.
- The amount of saved electricity is calculated from the moment when the air conditioner is turned on.
- The amount of saved electricity will vary, depending on the ambient environment (e.g., indoor/outdoor temperature and humidity), set temperature, and operation mode.
- Note that the amount of saved electricity also may differ even under the same operating environment conditions, depending on how it was measured.
- To have powerful cooling or heating, turn off AI Energy mode in the SmartThings app.

Power Smart Features



Cool mode

Use Cool mode to stay cool in hot weather.



NOTE

- After selecting Cool mode, select the desired function, temperature, and fan speed.
 - To cool more quickly, select a lower temperature and a faster fan speed.
 - To save energy, select a higher temperature and a slower fan speed.
 - As the room temperature nears the set temperature, the compressor motor will slow down to save energy.

25°
Dry

Dry mode

Use Dry mode in rainy or humid weather.



NOTE

- The proper set temperature range for dehumidifying operation is 24 to 26 °C. If you feel that the current humidity seems high, use a lower set temperature.
- You cannot use Dry mode for heating. Dry mode is designed to produce a cooling side-effect.

Fan

Fan mode

Use Fan mode to run the air conditioner like a floor fan, providing a breeze without heating or cooling.



NOTE

- If the air conditioner will not be used for an extended period of time, run it in Fan mode for 3 to 4 hours to dry the internal components.
- The outdoor unit does not operate in Fan mode. This is normal and not a fault with the air conditioner.

Power Smart Features

25°
Heat

Heat mode

Use Heat mode to stay warm.



NOTE

- While the air conditioner warms up, the fan may not operate for about 3 to 5 minutes at the beginning to prevent cold draft.
- If the air conditioner heats insufficiently, use an additional heating appliance in combination with the air conditioner.

Automatic defrost

When the outdoor temperature is low and the humidity is high, frost may develop on the outdoor heat exchanger, which may decrease heating efficiency. When these conditions are met while Heat mode is on, the air conditioner runs the Defrost function for 5 to 12 minutes to remove frost from the outdoor heat exchanger.

NOTE

- When the Defrost function is on, the **df** (Defrost) indicator appears on the indoor unit display, steam is produced on the outdoor unit, the airflow blades do not move. (Note that on the multi system, the blades move to the lowest position. After defrost operation is complete, the blades return to the angle set by the user.)
- You cannot select other functions with the remote control until the Defrost function is finished.

Variety Smart Features

MAX
On

MAX
Off

MAX function

Use the MAX function to quickly cool or heat your room. This function is the most powerful cooling and heating function provided by the air conditioner. You can select this function in Cool or Heat mode.

In Cool or Heat mode ► 

NOTE

- You can change the airflow direction, but you cannot change the set temperature and the fan speed.
- When you select the MAX function in Heat mode, you may not be able to increase the fan speed for 3 to 5 minutes while the unit heats up.
- Selecting the MAX function cancels the Dry Comfort, WindFree Cooling, Eco, Good Sleep, and Quiet functions.

Variety Smart Features



Eco function

For the multi system, this function is not supported.

Use the Eco function to reduce electricity consumption while staying cool or warm. You can select this function in Cool or Heat mode.

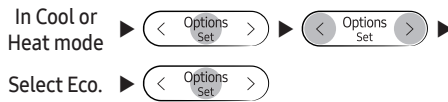

NOTE

- When the Eco function starts, the vertical air swing begins.
- You can change the set temperature, airflow direction, and fan speed.
- The allowed set temperatures while the Eco function is on are:

Mode	Minimum set temperature	Maximum set temperature
Cool	24 °C	30 °C
Heat	16 °C	30 °C

- If you change the set temperature to be outside the allowed range for the current mode, the set temperature is automatically reset to be within the range.
- When you turn off the Eco function, the air swing continues. Use the airflow direction adjustment function to turn it off.
- Selecting the Eco function cancels the Dry Comfort, WindFree Cooling, Good Sleep, MAX, and Quiet functions.



Quiet

Quiet function

Use the Quiet function to reduce the unit's operating noise. You can select this function in Cool or Heat mode.



NOTE

- You can change the set temperature and the airflow direction, but you cannot change the fan speed.
- Selecting the Quiet function cancels the Dry Comfort, WindFree Cooling, Eco, Good Sleep, and MAX functions.



Beep

Beep function

Use the Beep function to turn on or off the beep that sounds when you press a button on the remote control.

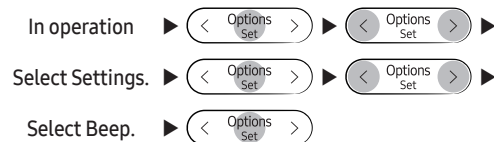

Variety Smart Features



Auto Clean

Auto Clean function

Use the Auto Clean function if the indoor unit produces odors.

Activating Auto Clean

To activate Auto Clean, press the  (Options) button for at least 3 seconds.

The indoor unit display shows:

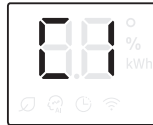

If the air conditioner is off, Auto Clean starts immediately. If the air conditioner is running, Auto Clean starts as soon as the air conditioner turns off.

NOTE

- You can also activate Auto Clean from the Options menu:



- Once Auto Clean is selected, it is always activated whenever the air conditioner turns off.
- Auto Clean runs for 10 to up to 30 minutes depending on internal dry conditions. The indoor unit display shows the cleaning progress from 1% to 99%.
- If you start another function while Auto Clean is progressing, Auto Clean pauses and will resume when the other function stops.
- When Auto Clean completes, the air conditioner turns off.
- Auto Clean does run after Timed off and Good Sleep function operation, but Auto Clean does not run after Heat or Fan mode.

Canceling Auto Clean

To cancel Auto Clean while it is running, follow the procedure below:

 ► Press and hold for 3 or more seconds.

or

 ►  ► Select Auto Clean. ►



NOTE

- Canceling Auto Clean does not deactivate it.

Deactivating Auto Clean

To deactivate Auto Clean, follow the procedure below while the air conditioner is in operation:

 ► Press and hold for 3 or more seconds.

or

 ►  ► Select Auto Clean. ►



Variety Smart Features



Freeze Wash function

For the multi system, this function is not supported.

Use the Freeze Wash function to wash away airborne contaminants or dust on the surface of the indoor heat exchanger by freezing and thawing operation.

In operation stop condition,



NOTE

- The Freeze Wash function runs from 30 to 80 minutes (the outdoor unit will operate) depending on either temperature or humidity in the room, through the following cycle: freezing → defrosting → drying of the indoor unit heat exchanger.
- The indoor unit display shows the cleaning progress (1-99 %).
- To use another function while in Wash operation, press the (Power) button on the remote control to stop the operation.
- When the room temperature is low or its humidity is high, the Freeze Wash function may not work.
- Before finishing the Freeze Wash function, the airflow blade is closed, and the drying operation starts.
- During the Freeze Wash cycle, creaking noises might be heard from the indoor unit. This is normal and will stop at the end of the Freeze Wash cycle.
- The area around the indoor unit may appear blurred or condensation may form while the Freeze Wash function is in operation.
- You may see frost or water on the surface of the outdoor unit's valve while the Freeze Wash function is in operation.
- It is recommended to use the Freeze Wash function once every 2 weeks. Otherwise, dust or dirt that is difficult to remove may accumulate in the heat exchanger.



Lighting

Display lighting function

Use the Display lighting function to turn on or off the lighting of the indoor unit display.

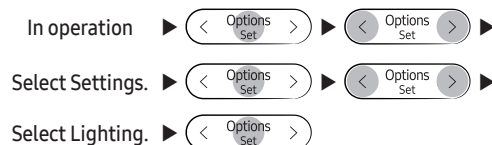

NOTE

- If you change the current mode or function when the Display lighting function is on, the display lighting turns on for 5 seconds and then turns off again.
- To turn off the Display lighting function, run the method above again or turn the product off and on.

AP

Wi-Fi function (SmartThings app)

Turn on the Wi-Fi function to pair your smartphone with the air conditioner.



► Press and hold for 5 or more seconds.

NOTE

- When you turn on the Wi-Fi function, your smartphone pairs with the air conditioner, **AP** appears on the remote control display for a few seconds.
- Once your smartphone is connected with the air conditioner, you can control it via the wireless Internet using the SmartThings app installed on your smartphone.
- For more information about how to prepare your smartphone for connection and how to control the air conditioner using the SmartThings app, see "SmartThings app" on page 47.
- To turn on or off the Wi-Fi, press and hold the  and  buttons for 5 seconds.
 - In order to launch the SmartThings app, press and hold the  button for 5 seconds, which enables to connect the air conditioner.

Time scheduling



Timed on/ Timed off function

Use the Timed on/off function to turn the air conditioner on or off after a duration. Scheduling durations before the air conditioner turns on or off helps use the air conditioner economically.

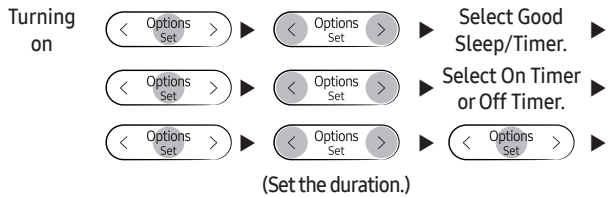

Confirm that on the indoor unit display is turned on.

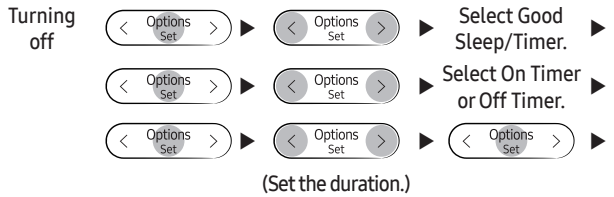

Confirm that on the indoor unit display is turned off.

NOTE

- To cancel the Timed on/off function, set the duration to 00 m.
- If the remote control is off and you select Timer/Good Sleep, **[On Timer]** appears on the remote control display. If the remote control is on and you select Timer/Good Sleep, **[Off Timer]** appears.
- You can set the duration to from 30 minutes to 24 hours.
- You cannot set the same duration for both Timed on and Timed off functions.

Combining Timed on and Timed off	
When the air conditioner is off	Example: Timed on 3 hours, Timed off 5 hours The air conditioner turns on 3 hours after the last time you press the button to start the Timed on/off function, remains on for 2 hours, then turns off again.
When the air conditioner is on	Example: Timed on 3 hours, Timed off 1 hour The air conditioner turns off 1 hour after the last time you press the button to start the Timed on/off function, remains off for 2 hours, then turns on again.

Timed on/ Timed off function

If you set the Timed on function, you can change the mode or temperature while the remote control is off.

Basic selection

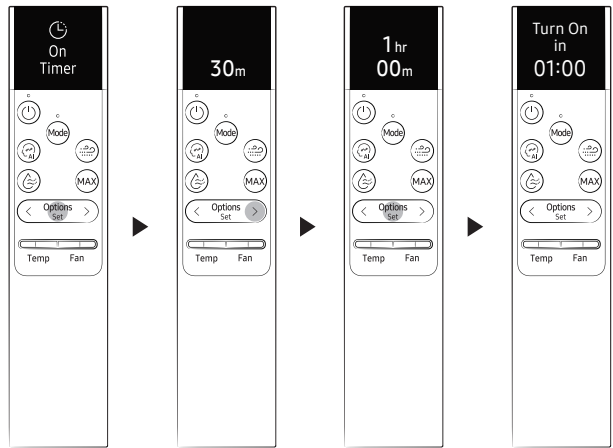

Additional selection

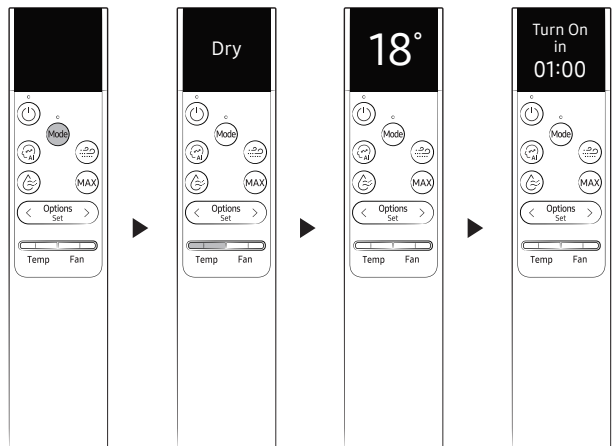

Time scheduling



Good Sleep function

Use the Good Sleep function to save energy while you are sleeping. You can select this function in Cool or Heat mode.

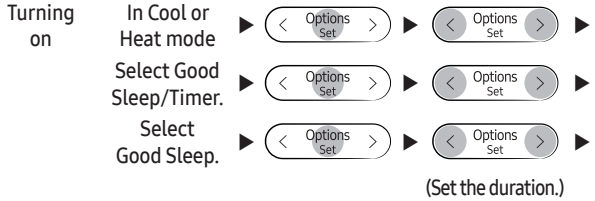

Confirm that on the indoor unit display is turned on.

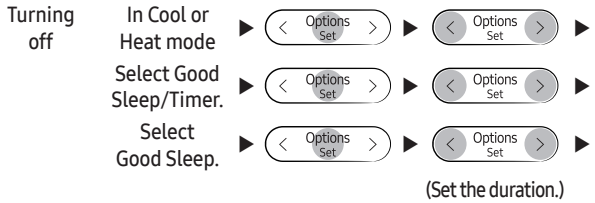

Confirm that on the indoor unit display is turned off.

NOTE

- To cancel the Good Sleep function, set the duration to 00 m.
- When you start the Good Sleep function, the (Timer) indicator appears on the indoor unit display.
- You can set the duration to from 30 minutes to 12 hours.
- The recommended set temperatures while the Good Sleep function is on are:

Mode	Recommended set temperature	Optimal set temperature
Cool	25 °C to 27 °C	26 °C
Heat	21 °C to 23 °C	22 °C

- The Good Sleep function can operate while the WindFree Cooling function is on.
- Selecting the Good Sleep function cancels Dry Comfort, Eco, MAX, and Quiet functions.

Schedule

Task	How often	By whom	Instruction
Run the Auto Clean function.	As needed	Owner	"Auto Clean function" on page 32.
Run the Freeze Wash function.	Once every two weeks	Owner	"Freeze Wash function" on page 34.
Clean the filter.	Once every two weeks	Owner	"Cleaning the filter" on page 41.
Replace the Tri-care filter.	Once every 3 years	Owner	"Replacing the Tri-care filter (For AR70F**C1*** models)" on page 42.
Clean the WindFree panel	At least once a month	Owner	"Cleaning the WindFree panel" on page 43.
Clean the exterior of the indoor unit.	As needed	Owner	"Cleaning the outside of the indoor unit" on page 40.
Clean the exterior of the outdoor unit.	At least once a year	Owner	"Cleaning the heat exchanger on the outdoor unit" on page 40.
Charge the remote control	As needed	Owner	"Charging the remote control" on page 18.
Apply corrosion inhibitor on outdoor unit. (Only if installed near salt water such as an ocean)	At least once a year	Qualified technician	Contact your service provider.
Clean inside the indoor or outdoor unit.	Once a year	Qualified technician	Contact your service provider.
Inspect the units, electrical connections, refrigerant pipes, and protections.	Once a year	Qualified technician	Contact your service provider.

Cleaning

Cleaning the outside of the indoor unit

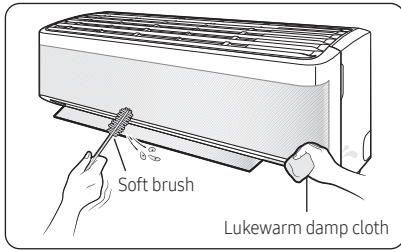

- 1 Turn off the air conditioner and wait until the fan stops.
- 2 Disconnect the power supply.
- 3 Use a soft brush or lukewarm damp cloth to clean the exterior.

⚠ WARNING

- Do not clean the appliance by spraying water directly onto it. Water entering the unit may result in electric shock or fire that could cause death, serious injury, or property damage:

⚠ CAUTION

- Do not use an alkaline detergent to clean the indoor unit display.
- Do not use sulphuric acid, hydrochloric acid, or organic solvents such as paint thinner, kerosene, acetone, benzene, or alcohol to clean the unit surfaces.

Cleaning the heat exchanger on the outdoor unit

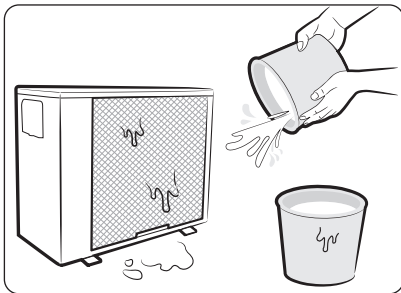

- 1 Turn off the air conditioner and wait until the fan stops.
- 2 Disconnect the power supply.
- 3 Spray water on the heat exchanger to remove dust and other debris.

⚠ CAUTION

- Do not use sulphuric acid, hydrochloric acid, or organic solvents such as paint thinner, kerosene, acetone, benzene, or alcohol to clean the unit surfaces.
- If you need to inspect or clean the inside of the heat exchanger on the outdoor unit, contact a local service centre for help.

Cleaning the filter

Clean the air filter every two weeks or when the **F** (filter-cleaning reminder) appears on the indoor unit display. The time between cleanings may vary, depending on the usage and environmental conditions.

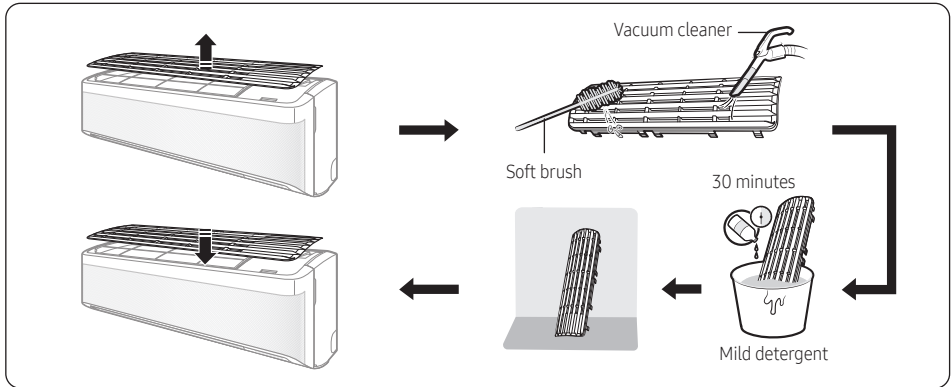

- 1 Slide the filter off of the unit.
- 2 Use a soft brush or vacuum cleaner to remove any dust or debris on the filter.
- 3 Soak the filter in a solution of water and mild detergent for 30 minutes.
- 4 Rinse the filter and let it air dry in a well-ventilated area that is out of direct sunlight.
- 5 Reinstall the filter.
- 6 Reset the filter-cleaning reminder:

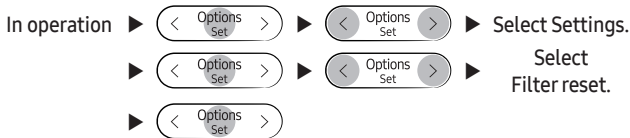

⚠ CAUTION

- Take care not to damage the filter during cleaning.
- Do not scrub the air filter with a hard-bristle brush or another cleaning utensil.
- Do not expose the air filter to direct sunlight when drying it.

Cleaning

Replacing the Tri-care filter (For AR70F**C1*** models)

Slide a new Tri-care filter in the direction of arrow 2.

Replace Tri-care filters once every three years. Replacement cycle may differ depending on the environment and usage time.

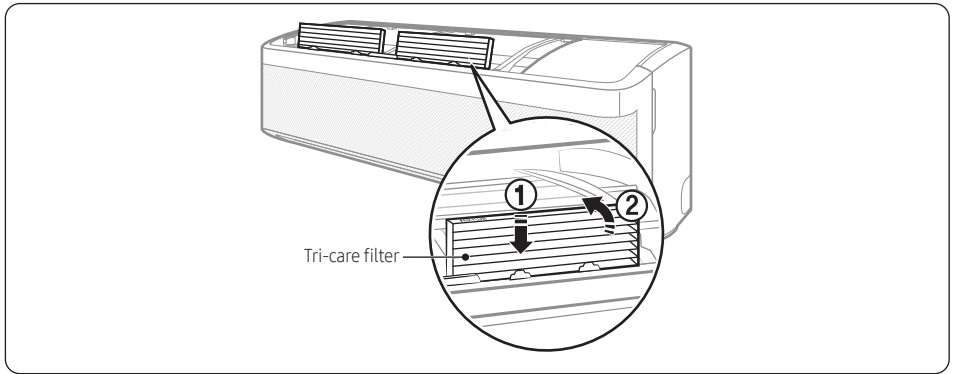

CAUTION

- Do not clean the Tri-care filter with water. Failing to do so may result in damage to the filter.

NOTE

- To replace a Tri-care filter, purchase a new one at a service centre.
- To use the Tri-care filter for a long time in an environment where fish cooking and smoking cause odour, ventilate the place by opening a window.

Cleaning the WindFree panel

Clean the WindFree panel at least once a month.

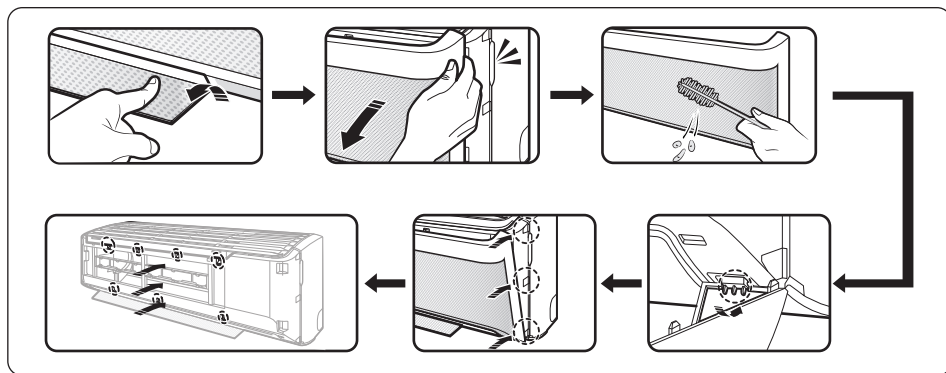

- 1 Pull the airflow blade open.
- 2 Hold and pull both sides of the WindFree panel until it comes free from the air conditioner.
- 3 Use a soft brush or vacuum cleaner to remove any dust.
- 4 Hang the WindFree panel in the grooves at the bottom left and right.
- 5 Align the projections of the WindFree panel with the grooves at the top, middle, and bottom of the front panel.
- 6 After inserting the WindFree panel, press the top 4 places and the bottom 3 places by hand so that there is no gap to the panel.

CAUTION

- If you attach the WindFree panel without the airflow blade being open, it may become obstructed by the WindFree panel and may not open properly.

Troubleshooting

If the air conditioner is not operating normally, refer to the troubleshooting guide below.

Problem	Solution
The air conditioner stops working.	<ul style="list-style-type: none"> • Make sure the unit is receiving power. • Check the circuit breaker. If it is flipped off, flip it on again and restart the unit. If the problem persists, contact your service provider. • The Timed off function may have turned off the unit. Turn on the unit again.
Cannot change the temperature.	<ul style="list-style-type: none"> • Check if the unit is in Fan or MAX mode. If so, you cannot change the set temperature; the unit automatically controls the set temperature.
Improper airflow temperature.	<ul style="list-style-type: none"> • Check the set temperature. In Cool mode, cooling occurs only when the set temperature is lower than the current temperature. In Heat mode, heating occurs only when the set temperature is higher than the current temperature. • Use the [Temp] button on the remote control to change the set temperature. • Check if the air filter is blocked with dirt or debris. If the air filter is blocked, the cooling and heating performance may decrease. Clean the air filter regularly (page 41). • Check if the outdoor unit is covered or is installed near obstacles. Remove the coverings and obstacles. • Check if the Defrost function is on (page 28). During defrost, the fan stops and warm air does not come out. • Check if doors or windows are open. This may cause poor circulation or performance. Close all doors and windows. • Check if the pipe length between the units exceeds the maximum pipe length (see "Typical installation" in the Installation manual). If so, the cooling and heating performance may decrease.
Cannot change the airflow direction.	<ul style="list-style-type: none"> • Check if the Good Sleep function is on in Cool mode. If so, you cannot control the airflow direction.
Cannot change the fan speed.	<ul style="list-style-type: none"> • Check if the unit is in AI Auto, Dry, or MAX mode or the Good Sleep function is on in Cool mode. In these conditions, you cannot control the fan speed; the unit automatically controls the fan speed.
The remote control does not work.	<ul style="list-style-type: none"> • Charge the remote control, using the USB port (type C) on the bottom of the remote control. • Make sure the remote control can send an unobstructed signal to the unit. • Keep bright lights away from the unit. Light from fluorescent bulbs or neon signs may interrupt the signal from the remote control.
The Timed on/off function does not work.	<ul style="list-style-type: none"> • Make sure to press the  button on the remote control when setting the timer.

Problem	Solution
The indicator on the indoor unit display blinks continuously.	<ul style="list-style-type: none"> • Press the  (Power) button to turn off the unit, or disconnect the power plug. • If the indicator light on the indoor unit display continues blinking, contact your service provider.
Odors are coming from the unit during regular operation.	<ul style="list-style-type: none"> • If the unit is operating in a smoky area, ventilate the room or operate the unit in Fan mode for 3 to 4 hours. There are no components in the unit that produce a strong odor. • Check if the drain pipes are clean. Clean them regularly.
The indoor unit display shows an error message.	<ul style="list-style-type: none"> • If the indoor unit indicator blinks, write down the error code. Contact your service provider and provide them with the error code.
The unit is generating noise.	<ul style="list-style-type: none"> • It is normal for the unit to generate some noise while operating. If the pipe length between the units is less than 3 m and no coil was used (see "Typical installation" in the Installation manual), additional noise may be transmitted from the outdoor unit to the indoor unit via the piping.
Smoke is coming from the outdoor unit.	<ul style="list-style-type: none"> • In winter, most likely this is steam coming from the outdoor heat exchanger while the Defrost function is on.
Water drips from the pipe connections on the outdoor unit.	<ul style="list-style-type: none"> • Condensation may develop when the ambient temperature or humidity changes significantly. This is normal.
Condensation forms on the surface of the indoor unit.	<ul style="list-style-type: none"> • If the humidity is higher in the room in Cool mode, or the difference between the desired temperature and indoor temperature is great, condensation may form on the surface of the indoor unit.

Information about Refrigerant

Important information: regulation regarding the refrigerant used.

This product contains fluorinated greenhouse gases. Do not vent gases into the atmosphere.

CAUTION

- If the system contains 5 tCO₂e or more of fluorinated greenhouse gases, it must be checked for leakage at least once every 12 months, according to regulation No. 517/2014. This activity must be covered by qualified personnel only. In the case of the situation above, the installer (or authorized person with responsibility for final check) must provide a maintenance book, with all the information recorded, according to REGULATION (EU) No. 517/2014 OF THE EUROPEAN PARLIAMENT AND OF THE COUNCIL of 16 April 2014 on fluorinated greenhouse gases.

Refrigerant type	GWP value
R-32	675

- GWP: Global Warming Potential
- Calculating tCO₂e: kg x GWP/1000

SmartThings app

Use the SmartThings app on your smartphone to control the air conditioner via the wireless Internet.

To remotely control the air conditioner, you need to connect your smartphone to the air conditioner. If already connected, skip to "Step 6. Controlling the air conditioner with your smartphone" on page 48.

Step 1. Checking the requirements for connection

Before connecting your smartphone with the air conditioner, make sure that the following requirements are met:

- Wi-Fi access point: 2.4 GHz Wi-Fi access point only
- The air conditioner and your smartphone must be within the coverage of the same Wi-Fi access point and connected to it. After the connection, you can control the air conditioner from any place via various wireless networks such as Wi-Fi, 3G, LTE and 5G.
- The supporting software version of the SmartThings app is subject to change according to the OS supporting policy the manufacturer provides. In addition, as for the SmartThings app or the functions that the app supports, the new application update policy on the existing OS version can be suspended due to usability or security reasons.
- The SmartThings app is subject to change without notice to improve usability or performance. As the mobile phone OS version is updated every year, the SmartThings is also updated continually according to the latest OS.
- If you have enquiries regarding the items mentioned above, please contact us on st.service@samsung.com.

Step 2. Connecting your smartphone to the Wi-Fi network

- 1 Turn on the Wi-Fi access point.
- 2 Tap **Settings** → **Wi-Fi** on your smartphone.
- 3 Tap the **Wi-Fi** switch to activate it, and then select the 2.4 GHz Wi-Fi access point to connect to.
- 4 If needed, enter the password for the access point.
- 5 Tap **Advanced**.
- 6 Tap the **Switch to mobile data** switch to deactivate it.

Step 3. Installing the SmartThings app

If the SmartThings app is not installed on your smartphone, follow the procedure below. If installed, skip to "Step 4. Configuring the SmartThings app" on page 47.

- 1 Launch **Play Store** or **App Store**.
- 2 Tap the search field, and then search for "SmartThings".
- 3 Tap **INSTALL** for the found SmartThings app item.
- 4 Select **Agree**.

Step 4. Configuring the SmartThings app

After the SmartThings app is installed, follow the procedure below to configure it. If already configured, skip to "Step 5. Connecting your smartphone to the air conditioner" on page 48.

- 1 Launch the **SmartThings** app.
- 2 When you see pop-up windows asking for location, Wi-Fi, Bluetooth permissions, tap **Start**.
- 3 Tap **Sign In**.
- 4 Sign in to your **Samsung account**.
 - If you have no Samsung account, create your Samsung account.
- 5 Consent to **TERMS AND CONDITIONS**.
- 6 When you see a pop-up window asking for access permission to location information, tap **ALLOW**.

SmartThings app

Step 5. Connecting your smartphone to the air conditioner

- 1 Plug in the power cord of the air conditioner, and then turn on the power.
- 2 Launch the **SmartThings** app.
- 3 Tap **Add device** on the home screen of the SmartThings app.
- 4 Tap **Samsung Air conditioner** > **Room air conditioner**.
- 5 Press the  button on the remote control for at least 4 seconds.

To notify that registration of the selected air conditioner to your Samsung account is in progress, the **AP** appears on the remote control display. When the connection is finished, the **AP** disappears. A new device card for the selected air conditioner is added to the home screen of the SmartThings app.

Step 6. Controlling the air conditioner with your smartphone

- 1 Launch the **SmartThings** app.
- 2 On the home screen of the SmartThings app, tap the device card for the air conditioner, which was added when you proceeded with "Step 5. Connecting your smartphone to the air conditioner" on page 48.

WARNING

- RF exposure warning statement – for keeping 20cm distance when installing this module.
- Warning that this module should not be installed and operating simultaneously with other radio without additional evaluation or FCC filing.
- Your device uses non-harmonised frequency and is intended for use in all European countries. The WLAN can be operated in the EU without restriction indoors, but cannot be operated outdoors in France.

Specifications

Wi-Fi	
Frequency Range	Transmitter Power (Max)
2412 - 2472 MHz	20 dBm

Open Source Announcement

The software included in this product contains open source software. You may obtain the complete corresponding source code for a period of three years after the last shipment of this product by contacting our support team via <http://opensource.samsung.com> (Please use the "Inquiry" menu.)

It is also possible to obtain the complete corresponding source code in a physical medium such as a CD-ROM; a minimal charge will be required.

The following URL http://opensource.samsung.com/opensource/SMART_AT_051/seq/0 leads to the open source license information as related to this product. This offer is valid to anyone in receipt of this information.



Security updates information

Security updates are provided to strengthen the security of your device and protect your personal information. For more information on security updates, visit <https://security.samsungda.com>.

* The website supports only some languages.

Reference

English	Hereby, Samsung declares that this radio equipment is in compliance with Directive 2014/53/EU and with the relevant statutory requirements in the UK. The full text of the EU declaration of conformity and the UK declaration of conformity is available at the following internet address: http://www.samsung.com , go to Support > Search Product Support and enter the model name.
Czech	Společnost Samsung tímto prohlašuje, že toto rádiové zařízení splňuje požadavky směrnice 2014/53/EU a příslušné požadavky právních norem platných ve Spojeném království. Úplné znění EU Prohlášení o shodě a UK Prohlášení o shodě je k dispozici na následující internetové adrese: http://www.samsung.com , kde klepněte na odkaz Podpora a do pole Hledat Podporu zadejte název modelu.
Danish	Samsung erklærer hermed, at dette radioudstyr er i overensstemmelse med direktiv 2014/53/EU og med relevante lovmæssige krav i Storbritannien. Hele teksten i EU-overensstemmelseserklæringen og UK-overensstemmelseserklæringen findes på denne webadresse: http://www.samsung.com . Gå til support > Søg efter produktsupport, og angiv modelnavnet.
German	"Samsung erklärt hiermit, dass diese Funkanlage mit der Richtlinie 2014/53/EU und den entsprechenden gesetzlichen Anforderungen im Vereinigten Königreich übereinstimmt. Der gesamte Text der EU-Konformitätserklärung und der Konformitätserklärung für das Vereinigte Königreich ist unter der folgenden Internetadresse verfügbar: http://www.samsung.com zu finden. Gehen Sie zu Support > Produktsupport durchsuchen und geben Sie den Modellnamen ein."
Estonian	Samsung kinnitab käesolevaga, et antud raadioseade vastab direktiivile 2014/53/EL ja asjakohastele seadusjärgsetele nõuetele Suurbritannias. EL-i vastavusdeklaratsiooni ja Suurbritannia vastavusdeklaratsiooni terviktekst on saadaval internetis järgmisel aadressil: http://www.samsung.com , avage menüü Tugi > Otsi toote tuge ja sisestage seejärel mudeli nimi.
Spanish	Por la presente, Samsung declara que este equipo radioeléctrico cumple con la Directiva 2014/53/UE y con los requisitos legales relevantes en el Reino Unido. El texto completo de la declaración de conformidad con la UE y de la declaración de conformidad con Reino Unido está disponible en la siguiente dirección de Internet: http://www.samsung.com , vaya a soporte > Búsqueda de soporte de productos e introduzca el nombre del modelo.
Greek	Συνηπώς, η Samsung δηλώνει ότι αυτός ο ραδιοεξοπλισμός συμμορφώνεται με την Οδηγία 2014/53/ΕΕ και με τις σχετικές νόμιμες απαιτήσεις του Ηνωμένου Βασιλείου. Το πλήρες κείμενο της δήλωσης συμμόρφωσης με την ευρωπαϊκή οδηγία και της δήλωσης συμμόρφωσης με τη βρετανική νομοθεσία είναι διαθέσιμο στη διεύθυνση: http://www.samsung.com . Επιλέξτε Υποστήριξη > Αναζήτηση υποστήριξης προϊόντος και εισαγάγετε το όνομα μοντέλου.
French	Par la présente, Samsung déclare que cet équipement radio est conforme à la directive 2014/53/UE et aux exigences réglementaires applicables au Royaume-Uni. Le texte intégral de la déclaration de conformité de l'UE et de la déclaration de conformité du Royaume-Uni est disponible à l'adresse Internet suivante : http://www.samsung.com , rendez-vous sur la page d'assistance > Rechercher dans l'Assistance et saisissez un nom de modèle.

Reference

Italian	Con la presente, Samsung dichiara che questa apparecchiatura radio è conforme alla Direttiva 2014/53/UE e ai relativi requisiti di legge nel Regno Unito. Il testo integrale della dichiarazione di conformità EU e del Regno Unito è disponibile al seguente indirizzo: http://www.samsung.com , selezionare supporto > Cerca Supporto Prodotto e inserire il nome del modello.
Latvian	Ar šo uzņēmums Samsung paziņo, ka šī radioiekārta atbilst Direktīvai 2014/53/ES un attiecīgajām likumiskajām prasībām Apvienotajā Karalistē. Pilns ES atbilstības deklarācijas teksts un Apvienotās Karalistes atbilstības deklarācijas teksts ir pieejams šajā interneta adresē: http://www.samsung.com , atverot Atbalsts > Meklēt produkta atbalstu un ievadot modeļa nosaukumu.
Lithuanian	Šiuo dokumentu „Samsung“ patvirtina, kad radijo įranga atitinka 2014/53/ES direktyvos reikalavimus ir JK susijusius įstatyminius reikalavimus. Visą ES atitikties deklaracijos ir JK atitikties deklaracijos tekstą rasite apsilankę internetinėje svetainėje adresu: http://www.samsung.com , eikite į skirtuką Palaikymas > Ieškoti gaminio palaikymo ir įveskite modelio numerį.
Dutch	Samsung verklaart hierbij dat deze radioapparatuur voldoet aan Richtlijn 2014/53/EU en aan de relevante statutaire vereisten in het VK. De volledige tekst van de EU-Conformiteitsverklaring en de conformiteitsverklaring van het VK vindt u op deze website: http://www.samsung.com , ga naar Ondersteuning > Productondersteuning zoeken en voer de modelnaam in.
Hungarian	A Samsung ezennel kijelenti, hogy ez a rádióberendezés megfelel a 2014/53/EU iránylevnek és az Egyesült Királyságból a vonatkozó jogszabályi követelményeknek. Az EU megfelelőségi nyilatkozat és az Egyesült Királyság megfelelőségi nyilatkozat teljes szövege a következő internet cím alatt található: http://www.samsung.com honlapon olvasható, lépjen a Támogatás > Terméktámogatás keresése menüpontra, és adja meg a modell nevét.
Polish	Niniejszym firma Samsung deklaruje, że ten sprzęt radiowy jest zgodny z wymogami dyrektywy 2014/53/UE oraz odnośnych ustaw obowiązujących w Wielkiej Brytanii. Pełny tekst deklaracji zgodności z przepisami europejskimi i brytyjskimi jest dostępny na stronie internetowej: http://www.samsung.com w menu Wsparcie > Szukaj, gdzie należy podać nazwę modelu.
Portuguese	A Samsung declara, pelo presente, que este equipamento de rádio está em conformidade com a Diretiva 2014/53/UE e com os requisitos legais relevantes no Reino Unido. O texto integral da declaração de conformidade europeia e da declaração de conformidade do Reino Unido está disponível no seguinte endereço da Internet: http://www.samsung.com , vá a Suporte > Pesquisar Suporte do produto e insira o nome do modelo.
Slovenian	Družba Samsung izjavlja, da je ta radijska oprema v skladu z Direktivo 2014/53/EU in ustreznimi zakonskimi zahtevami v Združenem kraljestvu. Celotno besedilo izjave ES o skladnosti in izjave Združenega kraljestva o skladnosti je na voljo na spodnjem internetnem naslovu: http://www.samsung.com . Pojdite na podpora > Iskanje podpore za izdelek, nato vnesite ime izdelka.

Slovak	Spoločnosť Samsung týmto vyhlasuje, že toto zariadenie rádiového typu je v súlade so smernicou 2014/53/EÚ a náležitými zákonnými požiadavkami v Spojenom kráľovstve. Celé znenie Vyhlásenia o zhode v EÚ a Vyhlásenia o zhode v Spojenom kráľovstve je k dispozícii na nasledujúcej internetovej adrese: http://www.samsung.com , prejdite na položky Podpora > Vyhľadávanie podpory produktov a zadajte názov modelu.
Finnish	Samsung vakuuttaa, että tämä radiolaitte on direktiivin 2014/53/EU ja Yhdistyneen kuningaskunnan oleellisten lakisääteisten vaatimusten mukainen. EU-vaatimustenmukaisuusvakuutuksen ja Yhdistyneen kuningaskunnan vaatimustenmukaisuusvakuutuksen koko teksti on saatavilla seuraavassa Internet-osoitteessa: http://www.samsung.com . Valitse Tuki > Etsi tuotetukea ja kirjoita mallinimi.
Swedish	Härmed deklarerar Samsung att denna radioutrustning uppfyller direktivet 2014/53/EU och de relevanta lagstadgade kraven i Storbritannien. Den fullständiga texten i EU-deklarationen om överensstämmelse och Storbritanniens deklaration om överensstämmelse finns tillgänglig på följande internetadress: http://www.samsung.com . Gå till stöd > Sök produktsupport och ange modellnamnet.
Bulgarian	С настоящото Samsung декларира, че това радиооборудване е в съответствие с Директива 2014/53/ЕС и със съответните закони изисквания в Обединеното кралство. Пълният текст на ЕС Декларацията за съответствие и Декларацията за съответствие за Обединеното кралство е наличен на следния интернет адрес: http://www.samsung.com , отидете на отидете на поддръжка > Търсене на поддръжка за продукт и въведете името на модела.
Romanian	Prin prezenta, Samsung declară faptul că acest echipament radio respectă Directiva 2014/53/UE și toate cerințele legale relevante din Regatul Unit. Textul complet al declarației de conformitate UE și al declarației de conformitate din Regatul Unit este disponibil la următoarea adresă de internet: http://www.samsung.com , accesați asistența > Căutați asistența produsului și introduceți numele modelului.
Norwegian	Samsung erklærer herved at dette radioutstyret er i samsvar med direktiv 2014/53/EU og med de relevante lovpålagte kravene i Storbritannia. Den fullstendige teksten til EU-samsvarserklæringen og den britiske samsvarserklæringen er tilgjengelig på følgende nettadresse: http://www.samsung.com . Gå til Support > Søk gjennom produktsupport og angi modellnavn.
Turkish	Samsung, bu radyo ekipmanının 2014/53/AB Direktifi ve Birleşik Krallık'taki ilgili yasal gerekliliklere uygun olduğunu beyan eder. AB uygunluk beyanının ve Birleşik Krallık uygunluk beyanının tam metni aşağıdaki internet adresinde mevcuttur: http://www.samsung.com adresinde bulabilirsiniz. Destek > Ürün Desteği Ara'ya gidin ve model adını girin.
Russian	Настоящим компания Samsung заявляет, что данное радиооборудование соответствует Директиве 2014/53/ЕС и соответствующим требованиям законодательства Великобритании. Полный текст декларации о соответствии ЕС и декларации о соответствии Великобритании доступен по следующему веб-адресу: http://www.samsung.com , перейдите в раздел Поддержка > Поиск продукта и введите имя модели.

Reference

Ukrainian	Цим компанія Samsung заявляє, що це радіообладнання відповідає вимогам Директиви 2014/53/ЄС і відповідним законодавчим нормам Великобританії. Повний текст декларації про відповідність нормам країн ЄС і Великобританії доступний за такою адресою в інтернеті: http://www.samsung.com ; перейдіть до розділу підтримки, потім — до поля пошуку підтримки для певного виробу та введіть назву моделі.
Serbian	Kompanija Samsung ovim izjavljuje da je ova radio oprema u skladu sa direktivom 2014/53/EU i sa odgovarajućim zakonskim zahtevima u UK. Kompletan sadržaj deklaracija o usaglašenosti za EU i UK dostupan je na sledećoj internet adresi: http://www.samsung.com , idite na Podrška > Pretraga podrške za proizvode i unesite naziv modela.
Croatian	Ovime Samsung izjavljuje da je ova radijska oprema usklađena s Direktivom 2014/53/EU i relevantnim uvjetima propisanim zakonom u Ujedinjenoj Kraljevini. Potpuni tekst EU deklaracije o sukladnosti te UK deklaracije o sukladnosti dostupan je na sljedećoj internetskoj adresi: http://www.samsung.com , ako odaberete Podrška > Traži podršku za proizvod i unesete naziv modela

Memo

QUESTIONS OR COMMENTS?

COUNTRY	CALL	OR VISIT US ONLINE AT
UK	0333 000 0333	www.samsung.com/uk/support
IRELAND (EIRE)	0818 717100	www.samsung.com/ie/support
GERMANY	06196 77 555 77	www.samsung.com/de/support
FRANCE	01 48 63 00 00	www.samsung.com/fr/support
SPAIN	91 175 00 15	www.samsung.com/es/support
PORTUGAL	210 608 098 Chamada para a rede fixa nacional Dias úteis das 9h às 20h	www.samsung.com/pt/support
LUXEMBURG	261 03 710	www.samsung.com/be_fr/support
NETHERLANDS	088 90 90 100	www.samsung.com/nl/support
BELGIUM	02-201-24-18	www.samsung.com/be/support (Dutch) www.samsung.com/be_fr/support (French)
NORWAY	21629099	www.samsung.com/no/support
DENMARK	707 019 70	www.samsung.com/dk/support
FINLAND	030-6227 515	www.samsung.com/fi/support
SWEDEN	0771-400 300	www.samsung.com/se/support
AUSTRIA	0800 72 67 864 (0800-SAMSUNG)	www.samsung.com/at/support
SWITZERLAND	0800 726 786	www.samsung.com/ch/support (German) www.samsung.com/ch_fr/support (French)
HUNGARY	0680SAMSUNG (0680-726-7864)	www.samsung.com/hu/support
CZECH	800 - SAMSUNG (800-726786)	www.samsung.com/cz/support
SLOVAKIA	0800 - SAMSUNG (0800-726 786)	www.samsung.com/sk/support
CROATIA	072 726 786	www.samsung.com/hr/support
BOSNIA	055 233 999	www.samsung.com/ba/support
North Macedonia	023 207 777	www.samsung.com/mk/support
MONTENEGRO	020 405 888	www.samsung.com/support
SLOVENIA	080 697 267 (brezplačna številka)	www.samsung.com/si/support
SERBIA	011 321 6899	www.samsung.com/rs/support
KOSOVO	038 40 30 90	www.samsung.com/support
ALBANIA	045 620 202	www.samsung.com/al/support
BULGARIA	0800111 31 - Безплатен за всички оператори *3000 - Цена на един градски разговор или сполег тарифата на мобилният оператор 09:00 до 18:00 - Понеделник до Петък	www.samsung.com/bg/support
ROMANIA	0800872678 - Apel gratuit *8000 - Apel tarifat în rețea Program Call Center Luni - Vineri: 9 AM - 6 PM	www.samsung.com/ro/support
ITALIA	800-SAMSUNG (800.7267864)	www.samsung.com/it/support
CYPRUS	8009 4000 only from landline, toll free	www.samsung.com/gr/support
GREECE	80111-SAMSUNG (80111 726 7864) only from land line (+30) 210 6897691 from mobile and land line	
POLAND	801-172-678* * (opłata według taryfy operatora)	http://www.samsung.com/pl/support/
LITHUANIA	8-800-7777	www.samsung.com/lt/support
LATVIA	8000-7267	www.samsung.com/lv/support
ESTONIA	800-7267	www.samsung.com/ee/support
UKRAINE	0-800-502-000	www.samsung.com/ua/support
MOLDOVA	+373-22-667-400	www.samsung.com/ua/support/moldova