



PERLIGHT
smart.black

Perlight Solar
PLM-OM Series
Installation Manual

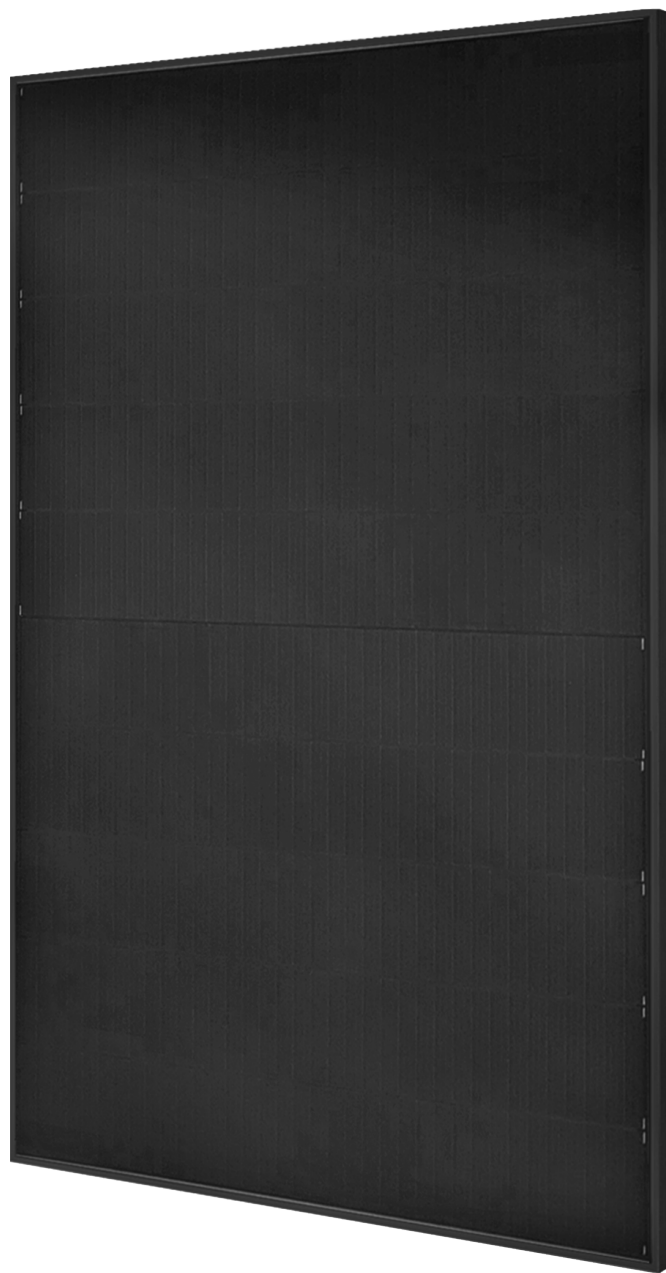



Table of Contents

1. Introduction	3
2. Applicable Modules	4
4. Warning and Notes	5-9
5. Identification	9
6. Module Structure	10
7. Mounting and Notes	11-13
8. Grounding	14
9. Module Wiring	15
10. Maintenance	16-17
11. Recycling	18



1. Introduction

This installation manual specifies the installation and maintenance requirements for crystalline silicon PV modules (“solar modules”) manufactured by Perlight Solar Co., Ltd.

This installation manual is intended for the installation and maintenance of solar modules, and helps customers to correctly install the photovoltaic power generation system. This installation manual does not apply to the installation of the Perlight double glass modules and conventional modules. Please read this manual carefully prior to handling and installation.

This manual contains important electrical and mechanical installation information. For correct installation, stable power output, installation and maintenance of the solar modules, carefully read and understand all installation instructions in the manual. Keep this manual in a safe place for future reference (care and maintenance) and in case of sale or disposal of the solar modules. This manual does not constitute a warranty, expressed or implied. Perlight does not assume responsibility and expressly disclaims liability for loss, damage, or expense arising out of or in any way connected with installation, operation, use or maintenance of the solar modules.

The mechanical and electrical installation of the solar modules shall be made in accordance with applicable laws and regulations, including electrical, construction and electrical connection requirements. These regulations vary depending on the installation site, such as building roofs, surface mounts, in-vehicle applications, and so on. The requirements may vary depending on the installation system voltage, the use of DC or AC. Please refer to the relevant local laws and regulations.

Installation and maintenance of Perlight Solar modules may only be carried out by trained and qualified personnel. If you require further information, contact your supplier or local Perlight Service Centre.

Please provide a copy of this manual to the owner and operator of the PV system for reference.

Thank you for choosing Perlight Solar PV modules.



2. Applicable Modules

This installation manual is applicable to the following Monocrystalline PERC PV modules:

PLM-xxxOM-78	PLM-xxxOM6-72	PLM-xxxOM-66
PLM-xxxOM2-78	PLM-xxxOM6B-72	PLM-xxxOM2-66
PLM-xxxOM2B-78	PLM-xxxOM6A-72	PLM-xxxOM2B-66
PLM-xxxOM2A-78	PLM-xxxOM6-72B	PLM-xxxOM2A-66
PLM-xxxOM-78B	PLM-xxxOM6B-72B	PLM-xxxOM-66B
PLM-xxxOM2-78B	PLM-xxxOM6A-72B	PLM-xxxOM2-66B
PLM-xxxOM2B-78B		PLM-xxxOM2B-66B
PLM-xxxOM2A-78B		PLM-xxxOM2A-66B
PLM-xxxOM6-60	PLM-xxxOM10-68	PLM-xxxOM10-57
PLM-xxxOM6B-60	PLM-xxxOM10-68B	PLM-xxxOM10-57B
PLM-xxxOM6A-60		
PLM-xxxOM6-60B		
PLM-xxxOM6B-60B		
PLM-xxxOM6A-60B		

Module dimensions and electrical performance data are detailed in the corresponding technical specification datasheets.

Module electrical performance parameters

The electrical performance parameters of the module were measured under standard test conditions (irradiance of 1000 W / m², AM 1.5 spectra, ambient temperature of 25 ° C) with a test uncertainty of ± 3%. The maximum system module voltage is 1500V.



4. Warning and Notes



Warning

Perlight Solar modules generate electricity when exposed to light. An array of modules can cause lethal shock and burn hazards. Only authorized and trained personnel should have access to the PV modules. To reduce the risk of electrical shock or burns, modules may be covered with an opaque material during installation. Do not touch live terminals with bare hands. Use insulated tools for electrical connections.

Each Perlight Solar module has a pair of male and female waterproof connectors. For a series electrical connection, connect positive (+) connector of first solar module to negative (-) connector of the following module. Do not short the positive and the negative. Do not disconnect under load. Ensure each connection is sound with no gap between the insulators. Poor connections may cause arcing and pose a fire and/or an electrical shock hazard.

Under normal conditions, a solar PV module is likely to experience conditions that produce more current and/or voltage than reported at standard test conditions. Accordingly the value of I_{sc} and V_{oc} marked on this module should be multiplied by a factor of 1.25 when determining component voltage ratings, conductor current ratings, fuse sizes, and sizes of controls connected to the Perlight Solar PV module output. Refer to local and national Electrical Code for any additional multiplying factors, which may also be applicable.

General Safety

Perlight Solar's modules have been evaluated by according to IEC61215 and IEC61730, application class A, modules rated for use in this application class may be used in system operating at greater than 50V DC or 240W. The safety class of the module is Class II, the class of fire rating is Class C (According to the standard is UL790), and the maximum series fuse is 20A.

Installing solar photovoltaic systems require specialized skills and knowledge. Installation should be performed only by qualified people. Installers should assume the risk of all injuries that might occur during installation, such as electric shock.

Photovoltaic modules are designed for outdoor use. Modules may be mounted on ground, rooftops, vehicles or boats. Proper design of support structures is the responsibility of the system designers or installers. When modules are mounted on rooftops, fire-protection rating of the final structure should be considered, and also the later maintenance. The rooftops and support structure for the PV system should only be certified by architectural experts or engineers, which have a formal complete structure analysis qualification.

For your safety, do not install the modules without safety precautions, do not install or handle the modules under wet or adverse environmental conditions, including but not limited to strong winds, gusty winds, frosted roof surfaces, wet environments.



Electrical Safety

When a module is exposed to sunlight or other light sources, a direct current is present inside the module, and electrical contact with the module may result in an electrical shock hazard. In order to avoid arc and electric shock, please do not disconnect electrical connections under load. Keep all electrical connectors dry and clean, and ensure that they are in proper working condition.

Do not insert other metal objects into the connectors.

Do not apply paint or adhesive to module surface. Do not wipe modules with corrosive chemicals.

Do not use mirrors or other magnifiers to focus sunlight on the modules.

Do not expose the backside of modules directly to sunlight for a long time.

Do not change the configuration of the bypass diodes.

Do not disassemble the modules.

Do not make contact with the module surface when the module is wet unless to clean the modules, please follow the requirements mentioned in this manual when cleaning.

Handling Safety

Do not open the box until it reaches the installation location. Keep the package dry and in a dry place.

Please refer to the Unpacking manual of standard packaging of Perlight Solar photovoltaic modules. During all handling procedures, make sure that the modules are not subject to large vibrations, that the modules fall to the floor or that objects fall on the module, as this will damage the modules or solar cell.

Special care must be taken not to bump, scrape, or press against the back of the module. Keep children and unauthorized persons away from the modules while transporting or installing them. Improper transportation or placing may lead to glass breakage or power loss of the modules, resulting in the loss of the use value of modules.

Handle modules with care, lift and put down modules gently. It is forbidden to carry or lift the modules by grasping the junction box or cables. Two or more people must hold the module with both hands.

Do not step on, stand or sit on the module, which can damage the module and create a risk to people.

Do not place any heavy objects on the front or back of the module, and do not place the module on a sharp object surface.



Installation Safety

Abide by the safety regulations for all other modules used in the PV system, including wiring and cables, connectors, controllers, inverters, storage batteries, etc., and use suitable equipment, connectors, wiring and mounting system for a PV system. If the PV system is used in storage batteries, the configuration with the modules should follow the advice of the storage batteries manufacturer. The same size, the same specifications of the model can be connected in series.

Do not install or handle the modules when they are wet or during strong wind. Keep the junction box's cover closed.

Damaged modules have the risk of electric shock and fire, such modules cannot be repaired and should be replaced immediately.

When exposed to direct sunlight, one individual solar module may generate DC voltages greater than 30 volts.

To reduce the risk of electric shock or burning, you can install modules with opaque material on the surface of the module. The mounting of the array of modules must be carried out with an isolating solar installation. Do not wear metal rings, watches, earrings and other metal accessories when installing or servicing PV systems. Do not touch the electrical parts of the module directly by hand. Use an insulated tool to make electrical connections and keep the tool dry.

The triangular holes on the backside frame of the module are drainage holes which cannot be blocked.

The maximum system voltage indicated in the rating label is 1500 V. During the system installation, the maximum open circuit voltage in series cannot exceed the maximum system voltage.

During module interconnection, ensure to fix the connecting cables to supporting mounting frame, so as to restrict cable movement.

Abide by the allowable minimum bending radius of the cables (suggest no less than 43mm). Always protect the cable with conduit where there is a risk of animals or children coming into contact with it.

Use connectors which are specially designed for photovoltaic systems, and assemble with the tools recommended or specified by the manufacturer. In case that the connector applicable to the solar system is required, please contact your local supplier. Only connectors of the same type must be used.

Make sure that the polarity is correct when connecting the module with inverter, storage battery or combiner box to avoid damage to bypass diodes in the modules due to incorrect polarity.

Do not drill holes in the frame, this may reduce the mechanical load ability and cause corrosion of the frame.

Do not scratch the anodized coating of the frame (except for grounding connection), this may cause corrosion of the frame or reduce the mechanical load ability.

Modules can't be used to replace the roof and wall materials, partial replacement is not allowed.

Any part (including nameplate) of modules supplied by Perlight Solar Co., Ltd can't be dismantled without permission.



Installation conditions

Working environment

Perlight Solar's solar module should operate in the following environmental conditions:

Ambient temperature: -20°C to $+45^{\circ}\text{C}$

Operating temperature of the module: -40°C to $+85^{\circ}\text{C}$

Humidity: 85%RH

Mechanical load bearing capacity: the modules have passed the mechanical load test of wind pressure of 2400Pa and snow pressure of 5400Pa; at the same time, they have passed the mechanical load test of wind pressure of 3600Pa and snow pressure of 3600Pa. (Only limited to the PV module models mentioned in this manual).

Note: The module mechanical load is based on the installation method and installation site. Calculation of mechanical load must be carried out by a professional installer according to the system design requirements.

Installation position

In most applications, PV modules should be installed in a location where they will receive maximum sunlight throughout the year. In the northern hemisphere, modules should typically face south, and in the southern hemisphere, modules should typically face north.

The module shall be installed in the place where sunshine is adequate. The module surface shall not be partly shaded by trees, building, clothes, tools, packaging materials, etc. because these objects will form shadow in the module surface leading to loss of system output power. The module shall be installed in a well-ventilated place; meanwhile, enough space for airflow shall be allowed at the back and sides of the module, so that the heat generated during operation can be radiated.

Modules cannot be used in excessive and harsh environments, such as hail, snow, sand, smoke, air pollution, soot, flammable gases, near open flames, and highly corrosive substances (salt, salt spray, salt water, acid rain), as this will affect the module's safety and performance. If the installation environment is special, such as coastal, farm, high humidity or wind and other large environment effects, please consult your local dealer for professional support and confirmation. If needed to be installed at a high altitude, the altitude should not exceed 2000m.

Modules should be installed on suitable buildings, or other suitable places to install modules (such as the ground, garage, building facades, roof).

If modules are installed in locations with frequent lightning activity, the modules must be protected against lightning strikes.

Do not install modules in locations with water immersion or near sprinkler systems.

The pressure of the wind or snow after installation of the modules must not exceed the maximum allowable load.



Tilt angle selection

The tilt angle of the Modules is measured between the surface of the modules and a horizontal ground surface, the modules generate maximum power output when it faces the sun directly, as shown in figure 2.

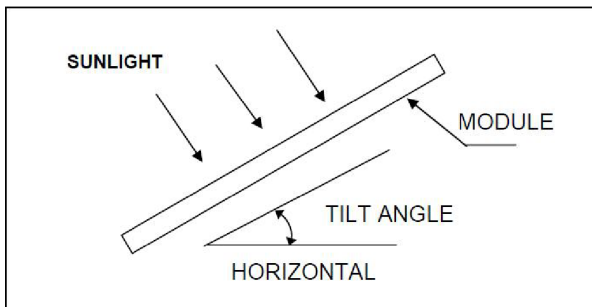

Fig.2: Installation angle

Degrees of Latitude	Tilt Angle
0° ~ 15°	15°
15° ~ 25°	Equal to Latitude
25° ~ 30°	Latitude + 5°
30° ~ 35°	Latitude + 10°
35° ~ 40°	Latitude + 15°
40° +	Latitude + 20°

Modules in series with the same array must be oriented in the same direction and angle. Different installation directions and angles will cause the modules to absorb the total solar radiation difference, causing the loss of output power, thus reducing the operating efficiency of the system.

The maximum power is generated when the sun is directed to the module, selecting the best installation angle should consider the sun path during the winter.

External or otherwise artificially concentrated sunlight shall not be directed onto the front or back face of the PV module.

5. Identification

Each PV module is affixed with two kinds of labels, providing the following information:

1. Label: Describes the product name, PV module model, nominal power, rated voltage, rated current, open circuit voltage, short circuit current, maximum system voltage, PV module size and weight under standard test conditions.
2. Serial number: Each module has a unique bar code number, each bar code number has 20 letters and numbers. The bar code is permanently encapsulated inside the module, as can be seen clearly from the top right corner of the module. The bar code number allows you to trace information about the module production process.



6. Module Structure

Module Front & Side (mm):

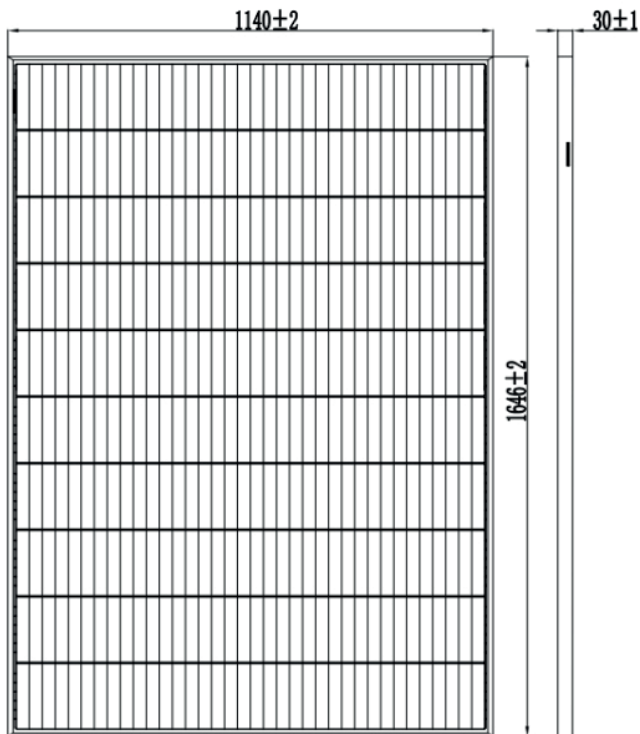

Module Rear (mm):

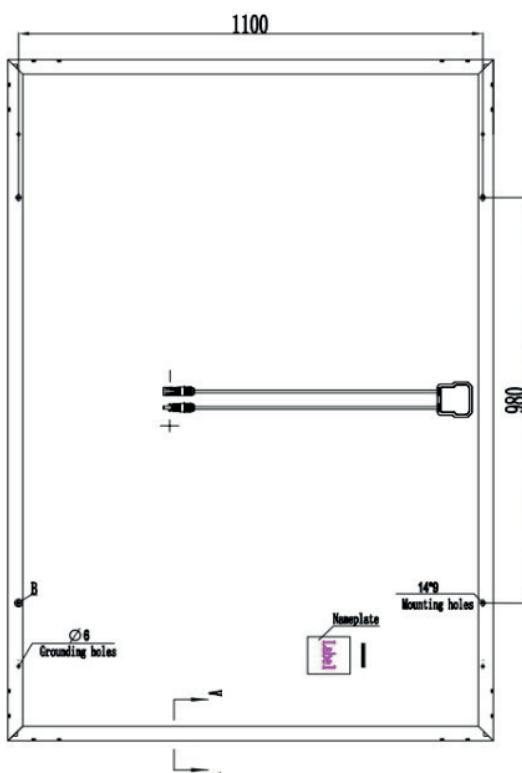

Frame size (mm):

A-A

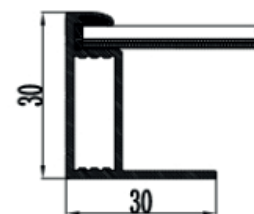

Mounting hole (mm):

B

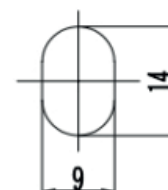



7. Mounting and Notes

The PV module frame is made of anodized aluminium, and therefore corrosion can occur if the module is subjected to a salt water environment with contact to a rack of another type of metal (Electrolysis Corrosion). If required, PVC, EPDM or stainless steel washers can be placed between the PV module frame and support structure to prevent this type of corrosion. Module support structures that are to be used to support Perlight Solar modules at the correct tilt angles should be wind and snow load rated for use by the appropriate local and civil codes prior to installation.

Perlight Solar modules can be mounted using the following methods:

- Direct fixing to mounting structure
- Suitable module clamps as part of solar mounting system
- Insertion systems
- Roof integrated systems

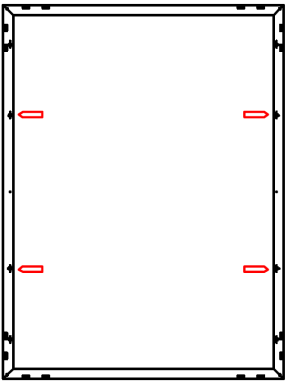
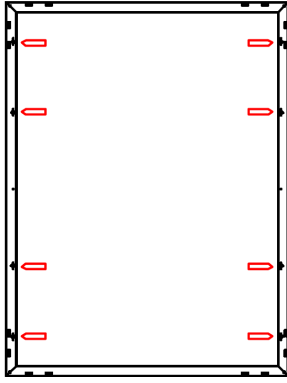
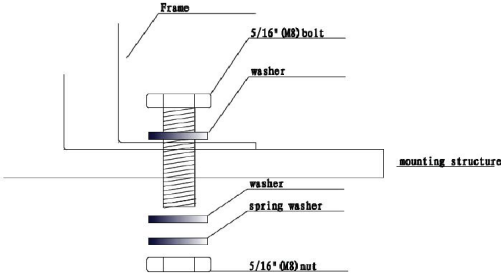
Direct Fixing to Mounting Structure	
2400Pa Wind Load 2400Pa Snow Load	5400Pa Wind Load 3800Pa Snow Load
	
Use Four Mounting Holes	Use Eight Mounting Holes
	<p>Direct Fixing to Mounting Structure</p> <p>The frame of each module has 8 mounting holes (14mm*9mm), which can be used to secure the modules to a supporting structure. The module frame must be attached to a supporting structure using corrosion-proof M8 stainless steel nuts and bolts with spring washers and flat washers in at least four points symmetrical on the PV module. Applied torque is approx. 16 Newton-meters.</p>

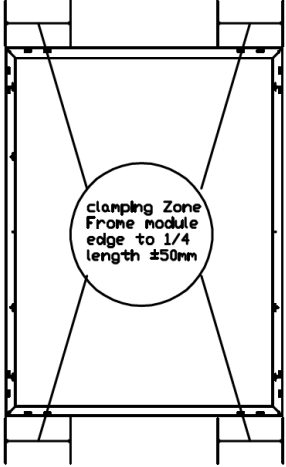
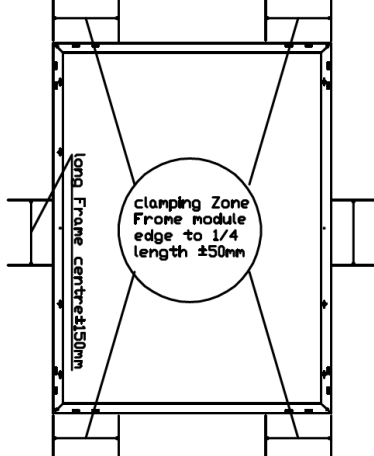
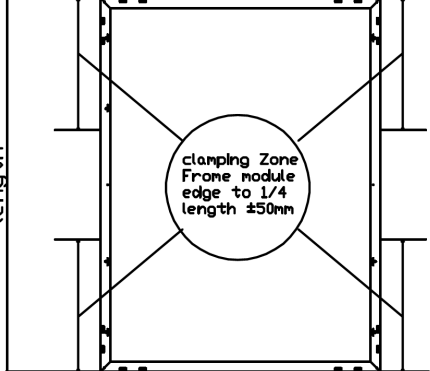
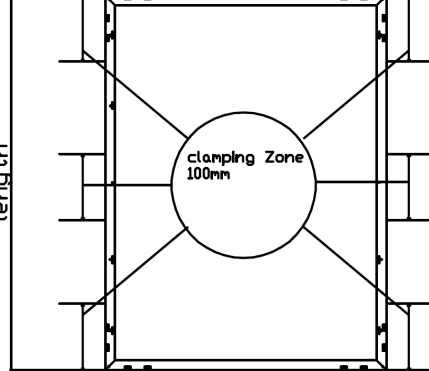

Solar Mounting Systems	
2400Pa Wind Load 2400Pa Snow Load	5400Pa Wind Load 3800Pa Snow Load
 <p style="text-align: center;">clamping Zone From module edge to 1/4 length ±50mm</p> <p style="text-align: center;">Fig.:3 Use Four Clamps</p>	 <p style="text-align: center;">clamping Zone From module edge to 1/4 length ±50mm</p> <p style="text-align: center;">long Frame center±150mm</p> <p style="text-align: center;">Fig.: 4 Use Four Clamps on Short Side and Two Clamps on Long Side</p>
 <p style="text-align: center;">clamping Zone From module edge to 1/4 length ±50mm</p> <p style="text-align: center;">length</p> <p style="text-align: center;">Fig.: 5 Use Four Clamps</p>	 <p style="text-align: center;">clamping Zone 100mm</p> <p style="text-align: center;">length</p> <p style="text-align: center;">Fig.:6 Use Six Clamps</p>

Module mounting clamps must not come into contact with the front glass and must not deform the frame. Module clamps should not cause shadowing effects. It is not permitted to modify the module frame under any circumstances. Recommended distance between two modules is 5mm considering linear thermal expansion of the module frames.

Clearance between the module frame and mounting surface may be required to prevent the junction box from touching the surface, and to circulate cooling air around the back of the module.

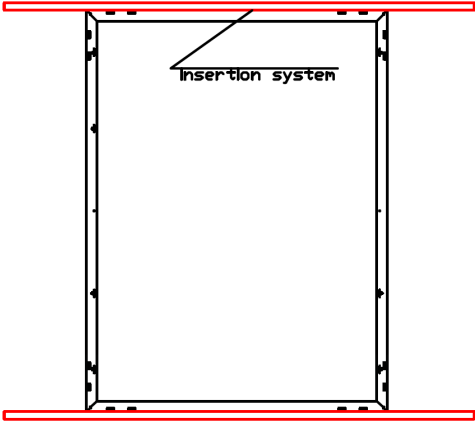
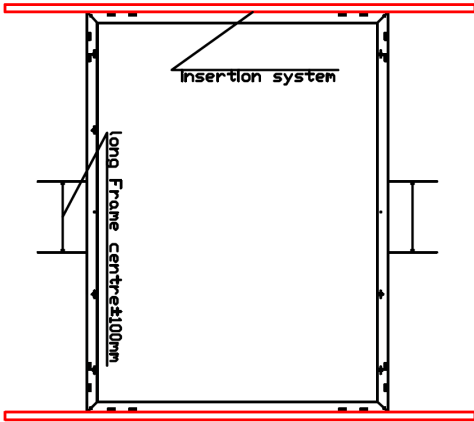
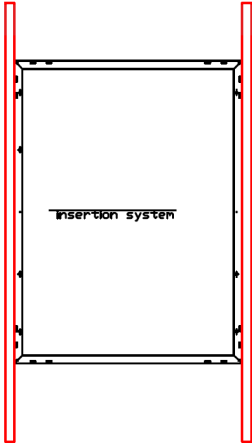

Insertion Mounting Systems	
2400Pa Wind Load 2400Pa Snow Load	5400Pa Wind Load 3800Pa Snow Load
 <p style="text-align: center;">Fig.: 7 Insertion System Short Side</p>	 <p style="text-align: center;">Fig.: 8 Insertion System Short Side and Two Clamps on Long Side.</p>
<p>Insertion Systems must not cause shadowing effects. It is not permitted to modify the module frame under any circumstances. Recommended distance between two modules is 5mm considering linear thermal expansion of the module frames.</p> <p>Clearance between the module frame and mounting surface may be required to prevent the junction box from touching the surface, and to circulate cooling air around the back of the module.</p>	 <p style="text-align: center;">Fig.: 9 Insertion System Long Side</p>

Mounting design may have an impact on fire resistance. If the modules are to be installed on the roof or wall of a building, using an integrated mounting system, the fire resistance of roof covering or wall should be rated for the application and certified for use to local and national standards. Here the stand-off method or the rack method is recommended. The modules are supported parallel to the surface of the building wall or roof. Clearance between the module frames and surface of the wall or roof is required to prevent wiring damage and to allow air to circulate behind the module. The recommended stand-off height is 115mm. Any slope less than 5in/ft (127mm/305mm) is required to maintain a fire class rating. Do not mount Perlight Solar module in such way that the drain holes of the module are intended to block up. Roof-integrated (in-roof) systems must comply with local and national regulations, including fire test certification where necessary.



8. Grounding

All module frames and mounting racks must be properly grounded in accordance with local and national electrical regulations. Proper grounding is achieved by connecting the module frame(s) and structural members continuously one to another using a suitable grounding conductor. The grounding conductor or strap may be copper, copper alloy, or other material acceptable for use as an electrical conductor as per local and national guidelines. The grounding conductor must then make a connection to earth using a suitable earth ground electrode.

Attach a separate conductor to one of the marked 4mm diameter grounding holes on the module frame with a bolt and nut that incorporates an external tooth washer. This is to ensure positive electrical contact with the frame.

The rack must also be grounded unless they are mechanically connected by nuts and bolts to the grounded Perlight Solar modules. The array frame shall be grounded in accordance with local and national guidelines.

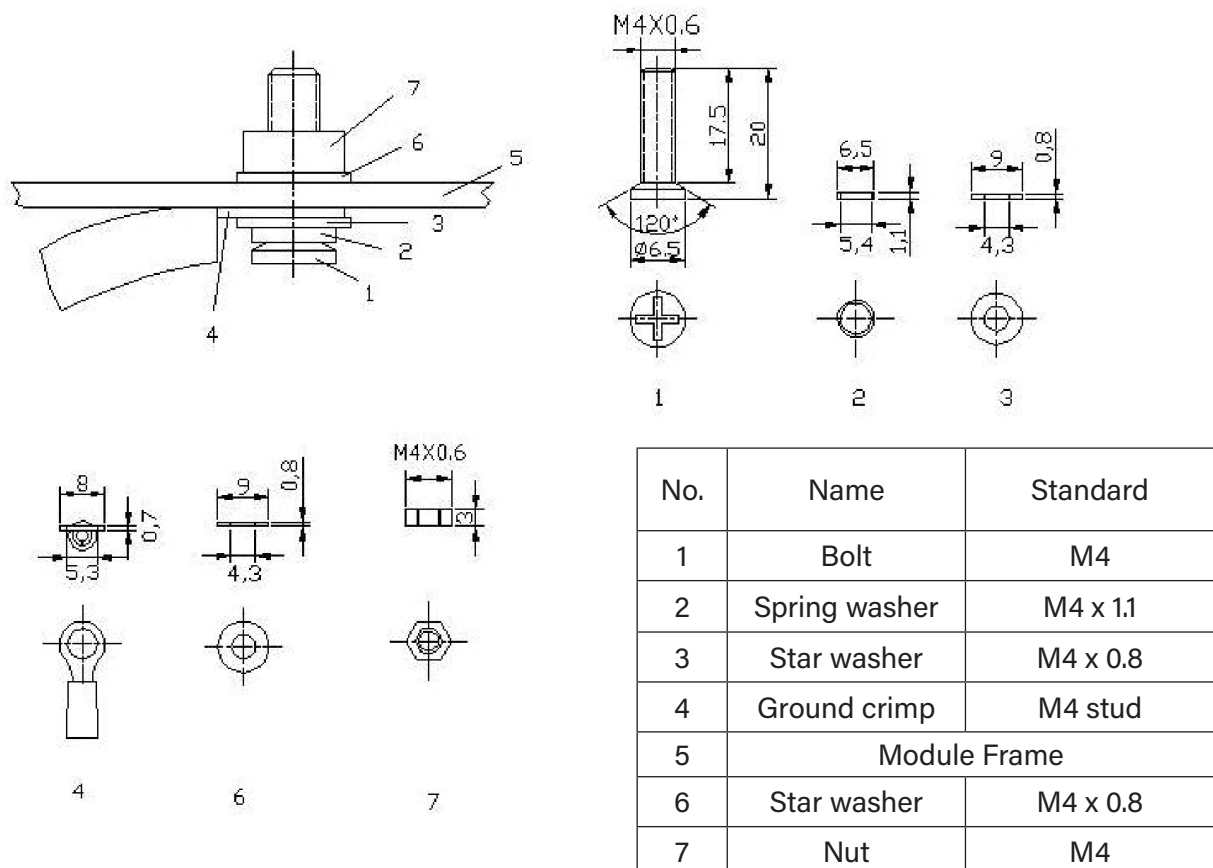

Fig.10: Grounding crimp and washer sizes



9. Module Wiring

Each solar module is wired with two separate series cell strings.

Bypass Diodes

Bypass diodes are wired in parallel with the series cell strings to prevent hot spot heating caused by individual cell reverse bias that occurs when a module is partially shaded.

Output Cables

Each module has two standard 90°C rated, water-proof, UV resistant output cables each terminated with plug & play connectors. This cable is suitable for applications where wiring is exposed to the direct rays of the Sun.

Field connections

Connecting cables should be a minimum of 12 AWG copper cables, which are UV resistant and insulated for a minimum of 90°C. All wiring and electrical connections must comply with local and national Electrical Code.

Blocking Diodes

In a system utilizing a battery, blocking diodes are typically placed between the battery and the solar module output to prevent battery discharge at night. Diodes that are used as blocking diodes must: Have a Rated Average Forward Current [$I_{F(AV)}$] above maximum system current at highest module operating temperature. Have a Rated Repetitive Peak Reverse Voltage [V_{RRM}] above maximum system voltage at lowest module operating temperature.



10. Maintenance

Modules need to be inspected and maintained regularly, especially during the warranty period. To ensure optimum performance of the modules, the following maintenance measures are recommended.

Cleaning

When modules are working, there should not be environmental factors creating shadows on the modules, such as other modules, supporting rail, plants, heavy dust, dirt etc., which may directly reduce the power output and may even cause regional hot-spot effects. Therefore, clean the glass surface on a regular basis, clean modules take measures so as:

The frequency of cleaning depends on the rate of dirt build-up. Under normal conditions, the rain will clean the surface of the module, but it is still required to regularly clean the module surface using a soft sponge or cloth (dry or wet).

Never use a rough surfaced material to clean modules, do not use acid and alkali cleaner to remove dirt.

Avoid pressing hard during cleaning, which may cause glass deformation, cell damage and reduction of the module's life.

During snow, remove the snow covered on the module in time to avoid the module damage caused by long-term accumulation of snow cover and freezing of melted snow.

When cleaning the rear of the module, avoid piercing backsheet.

It is recommended that modules be cleaned in the early morning or late afternoon when light is low and the module temperature is low, especially for areas with high temperatures.



Annual Checks

Once a year, check the tightness of terminal screws and the general condition of the wiring. Also, check to ensure the mounting hardware is tight and secure. Loose connections will result in damage to the array.



Changed Perlight Solar modules must be of the same kind and type. Do not touch live parts of cables and connectors. Use appropriate safety equipment when working (insulated tools, insulating gloves, etc.).

Warning

Only trained personnel may carry-out repair work to the PV modules and system components.

Cover the front surface of the solar module with an opaque or other material when working on the modules. Solar modules generate high voltage when exposed to sunlight.

Visual inspection

Please carefully check the modules of the existence of visual defects, focusing on the following items:

- a) Check whether the module glass is broken.
- b) Check if the front of the module is obstructed by obstacles or foreign objects.
- c) Check the module backsheet, whether there is hot, negative film raised, signs of burns or scorching and so on.
- d) Check whether the encapsulation materials of the module have delamination, bubbles, etc.
- e) Check the tightness of the bolts and the electrical connections at the connection points between the modules and the supporting rail.

Inspection of connectors and cables

It is advisable to carry out a preventive check every 6 months and check the following:

- a) Check Junction box adhesive for cracks.
- b) Check the connector interface sealing tightness, signs of melting, aging or corrosion.
- c) Check that the cable connections are secure and that the modules are properly grounded.

When a module is found to be defective, consult a qualified service technician. If servicing is required, it should be serviced by a qualified service technician. Module exposure generates high voltages in the sun, so cover the modules with opaque material when servicing modules to prevent electrical shock.

Note:

1. Any problems discovered should be referred to a professional service technician for confirmation;
2. If using maintenance and repair measures not included in this manual, consult your local dealer for professional support.



11. Recycling

Perlight work to avoid unnecessary waste, keeping module packaging to a minimum, while maintaining the protection of the modules during transport.

Please recycle the cardboard and paper packaging in accordance with local guidelines and regulations.

End of Life Disposal and Recycling

Perlight solar modules are designed to produce electricity for a minimum of 25 years, however the panels may continue to offer useful energy for years to come after this point. Once the panels reach the end of their useful life, they should be recycled in accordance with local guidelines and regulations.

Within the European Union, solar modules are subject to Waste Electrical and Electronic Equipment (WEEE) regulations. The WEEE symbol is displayed on every module nameplate label at the rear of the panel. This means that this product shall not be treated as household waste and must be disposed of at an appropriate collection point.

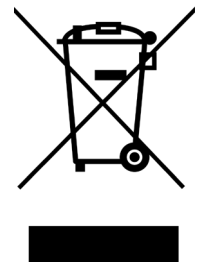

Fig.11: WEEE Symbol

Perlight Solar Co.,Ltd.

Address:
Oufeng Road,
Muyu, Zeguo Town,
Wenling City,
Zhejiang Province,
317521, China

Tel: 0086-576-86477920
www.perlight.com
enquiry@perlight.com