



PERLIGHT
smart.black

Perlight Solar PLM Series Module Installation Manual





Table of Contents

1. Introduction	3
2. Class Application	3
3. Applicable Modules.....	4-6
4. Warning and Notes.....	7
5. Permit	8
6. Climate Condition.....	8
7. Module Structure.....	8
8. Site Selection.....	9
9. Module Tilt Angle.....	9
10. Mounting and Notes.....	10-12
11. Grounding.....	13
12. Module Wiring	14
13. Maintenance.....	15
14. Recycling.....	16



1. Introduction

Perlight Solar modules consist of a series of electrically interconnected crystalline silicon solar cells, which are permanently encapsulated between a tempered glass superstrate and substrate. The entire laminate is secured within an anodized aluminium frame for structural strength; ease of installation and to protect the cells from the most severe environmental conditions.

Perlight Solar modules are a highly reliable, virtually maintenance-free direct current (DC) power source, designed to operate efficiently in sunlight. Perlight Solar modules are ideal for all applications, Residential, Commercial and Utility-Scale. Perlight Solar modules may also be used to power remote homes, recreational vehicles, water pumps, telecommunication systems and many other applications either with or without the use of storage batteries.

Please read this manual carefully prior to handling and installation.

Installation and maintenance of Perlight Solar modules may only be carried out by trained and qualified personnel.

If you require further information, contact your supplier or local Perlight Service Centre.

Please provide a copy of this manual to the owner and operator of the PV system for reference.

Thank you for choosing Perlight Solar PV modules.

2. Class Application

The modules are qualified for application class A: Hazardous voltage (IEC 61730: higher than 50V DC; EN 61730: higher than 120V), hazardous power applications (higher than 240W) where general contact access is anticipated (Modules qualified for safety through EN IEC 61730-1 and -2 within this application class are considered to meet the requirements for Safety Class II).



3. Applicable Modules

This installation manual is applicable to the following modules:

PLM-295MB-54 1504*1002*35	PLM-335OMB-66 1699*992*35	PLM-390DHMB-144 2035*1006*30
PLM-300DHMB-120 1709*1006*30	PLM-335OMB-66 1699*992*40	PLM-390HMB-144 2008*1002*40
PLM-300MB-60-5 1665*1002*35	PLM-340DHMB-120 1704*1008*30	PLM-390HMB-144-5 2008*1002*40
PLM-305DHMB-120 1704*1008*30	PLM-340DHMB-120 1709*1006*30	PLM-390HMB-144-9 2008*1002*40
PLM-305DHMB-120 1709*1006*30	PLM-340HMB-120 1685*1002*35	PLM-390MB-72-5 1979*1002*40
PLM-305HMB-120-5 1685*1002*35	PLM-340HMB-120-5 1685*1002*35	PLM-390MB-72-9 1979*1002*40
PLM-305MB-60-5 1665*1002*35	PLM-340HMB-120-9 1685*1002*35	PLM-390OMB-81 2067*998*40
PLM-310DHMB-120 1704*1008*30	PLM-340OMB-66 1699*992*35	PLM-390OMB-81 2076*992*40
PLM-310DHMB-120 1709*1006*30	PLM-340OMB-66 1699*992*40	PLM-395DHMB-144 2030*1008*30
PLM-310HMB-120 1685*1002*35	PLM-345DHMB-120 1704*1008*30	PLM-395DHMB-144 2035*1006*30
PLM-310HMB-120-5 1685*1002*35	PLM-345DHMB-120 1709*1006*30	PLM-395HMB-144 2008*1002*40
PLM-310MB-60-5 1665*1002*35	PLM-345OMB-66 1699*992*35	PLM-395HMB-144-5 2008*1002*40
PLM-315DHMB-120 1704*1008*30	PLM-345OMB-66 1699*992*40	PLM-395HMB-144-9 2008*1002*40
PLM-315DHMB-120 1709*1006*30	PLM-355H6MB-120 1765*1048*35	PLM-395MB-72-5 1979*1002*40
PLM-315HMB-120 1685*1002*35	PLM-360DHMB-144 2030*1008*30	PLM-395MB-72-9 1979*1002*40
PLM-315HMB-120-5 1685*1002*35	PLM-360DHMB-144 2035*1006*30	PLM-395OMB-81 2067*998*40
PLM-315HMB-120-9 1685*1002*35	PLM-360H6MB-120 1765*1048*35	PLM-395OMB-81 2076*992*40
PLM-315MB-60-5 1665*1002*35	PLM-360MB-72-5 1979*1002*40	PLM-400DHMB-144 2030*1008*30
PLM-315MB-60-9 1665*1002*35	PLM-365DHMB-144 2030*1008*30	PLM-400DHMB-144 2035*1006*30
PLM-315OMB-66 1699*992*35	PLM-365DHMB-144 2035*1006*30	PLM-400HMB-144 2008*1002*40
PLM-315OMB-66 1699*992*40	PLM-365H6MB-120 1765*1048*35	PLM-400HMB-144-5 2008*1002*40
PLM-320DHMB-120 1704*1008*30	PLM-365HMB-144-5 2008*1002*40	PLM-400HMB-144-9 2008*1002*40
PLM-320DHMB-120 1709*1006*30	PLM-365MB-72-5 1979*1002*40	PLM-400MB-72-5 1979*1002*40
PLM-320HMB-120 1685*1002*35	PLM-370DHMB-144 2030*1008*30	PLM-400MB-72-9 1979*1002*40
PLM-320HMB-120-5 1685*1002*35	PLM-370DHMB-144 2035*1006*30	PLM-400OMB-81 2067*998*40
PLM-320HMB-120-9 1685*1002*35	PLM-370H6MB-120 1765*1048*35	PLM-400OMB-81 2076*992*40
PLM-320MB-60-5 1665*1002*35	PLM-370HMB-144 2008*1002*40	PLM-405DHMB-144 2030*1008*30
PLM-320MB-60-9 1665*1002*35	PLM-370HMB-144-5 2008*1002*40	PLM-405DHMB-144 2035*1006*30
PLM-320OMB-66 1699*992*35	PLM-370MB-72-5 1979*1002*40	PLM-405HMB-144 2008*1002*40
PLM-320OMB-66 1699*992*40	PLM-375DHMB-144 2030*1008*30	PLM-405HMB-144-5 2008*1002*40
PLM-325DHMB-120 1704*1008*30	PLM-375DHMB-144 2035*1006*30	PLM-405HMB-144-9 2008*1002*40
PLM-325DHMB-120 1709*1006*30	PLM-375HMB-144 2008*1002*40	PLM-405OMB-81 2067*998*40
PLM-325HMB-120 1685*1002*35	PLM-375HMB-144-5 2008*1002*40	PLM-405OMB-81 2076*992*40
PLM-325HMB-120-5 1685*1002*35	PLM-375HMB-144-9 2008*1002*40	PLM-410DHMB-144 2030*1008*30
PLM-325HMB-120-9 1685*1002*35	PLM-375MB-72-5 1979*1002*40	PLM-410DHMB-144 2035*1006*30



continued:

PLM-325MB-60-5 1665*1002*35	PLM-375MB-72-9 1979*1002*40	PLM-410HMB-144 2008*1002*40
PLM-325MB-60-9 1665*1002*35	PLM-380DHMB-144 2030*1008*30	PLM-410HMB-144-5 2008*1002*40
PLM-325OMB-66 1699*992*35	PLM-380DHMB-144 2035*1006*30	PLM-410HMB-144-9 2008*1002*40
PLM-325OMB-66 1699*992*40	PLM-380HMB-144 2008*1002*40	PLM-410OMB-81 2067*998*40
PLM-330DHMB-120 1704*1008*30	PLM-380HMB-144-5 2008*1002*40	PLM-410OMB-81 2076*992*40
PLM-330DHMB-120 1709*1006*30	PLM-380HMB-144-9 2008*1002*40	PLM-415DHMB-144 2030*1008*30
PLM-330HMB-120 1685*1002*35	PLM-380MB-72-5 1979*1002*40	PLM-415DHMB-144 2035*1006*30
PLM-330HMB-120-5 1685*1002*35	PLM-380MB-72-9 1979*1002*40	PLM-415OMB-81 2067*998*40
PLM-330HMB-120-9 1685*1002*35	PLM-385DHMB-144 2030*1008*30	PLM-415OMB-81 2076*992*40
PLM-330MB-60-5 1665*1002*35	PLM-385DHMB-144 2035*1006*30	PLM-420OMB-81 2067*998*40
PLM-330MB-60-9 1665*1002*35	PLM-385HMB-144 2008*1002*40	PLM-420OMB-81 2076*992*40
PLM-330OMB-66 1699*992*35	PLM-385HMB-144-5 2008*1002*40	PLM-425H6MB-144 2108*1084*40
PLM-330OMB-66 1699*992*40	PLM-385HMB-144-9 2008*1002*40	PLM-425OMB-81 2067*998*40
PLM-335DHMB-120 1704*1008*30	PLM-385MB-72-5 1979*1002*40	PLM-425OMB-81 2076*992*40
PLM-335DHMB-120 1709*1006*30	PLM-385MB-72-9 1979*1002*40	PLM-430H6MB-144 2108*1084*40
PLM-335HMB-120 1685*1002*35	PLM-385OMB-81 2067*998*40	PLM-435H6MB-144 2108*1084*40
PLM-335HMB-120-5 1685*1002*35	PLM-385OMB-81 2076*992*40	PLM-440H6MB-144 2108*1084*40
PLM-335HMB-120-9 1685*1002*35	PLM-390DHMB-144 2030*1008*30	PLM-445H6MB-144 2108*1084*40

This manual may also be applied to legacy modules. See Page 6 for a list of applicable modules.



3. Legacy Modules

This installation manual is applicable to the following legacy modules:

PV Modules with 6" Mono-crystalline Cells:	PV Modules with 6" Poly-crystalline Cells:	PV Modules with 5" Mono-crystalline Cells:
72 cells: PLM-***M-72 (** = 245-385)	72 cells: PLM-***P-72 (** = 235-355)	96 cells: PLM-***M-96 (** = 230-280)
72 cells: PLM-***MA-72 (** = 245-385)	72 cells: PLM-***PA-72 (** = 235-355)	96 cells: PLM-***MA-96 (** = 230-280)
72 cells: PLM-***MB-72 (** = 245-385)	72 cells: PLM-***PB-72 (** = 235-355)	96 cells: PLM-***MB-96 (** = 230-280)
66 cells: PLM-***M-66 (** = 215-350)	66 cells: PLM-***P-66 (** = 225-325)	72 cells: PLM-***M-72 (** = 160-210)
66 cells: PLM-***MA-66 (** = 215-350)	66 cells: PLM-***PA-66 (** = 225-325)	72 cells: PLM-***MA-72 (** = 160-210)
66 cells: PLM-***MB-66 (** = 215-350)	66 cells: PLM-***PB-66 (** = 225-325)	72 cells: PLM-***MB-72 (** = 160-210)
60 cells: PLM-***MA-60 (** = 220-320)	60 cells: PLM-***P-60 (** = 195-295)	66 cells: PLM-***M-66 (** = 145-190)
60 cells: PLM-***MA-60 (** = 220-320)	60 cells: PLM-***PA-60 (** = 195-295)	66 cells: PLM-***MA-66 (** = 145-190)
60 cells: PLM-***MB-60 (** = 220-320)	60 cells: PLM-***PB-60 (** = 195-295)	66 cells: PLM-***MB-66 (** = 145-190)
54 cells: PLM-***M-54 (** = 185-285)	54 cells: PLM-***P-54 (** = 180-265)	60 cells: PLM-***M-60 (** = 130-175)
54 cells: PLM-***MA-54 (** = 185-285)	54 cells: PLM-***PA-54 (** = 180-265)	60 cells: PLM-***MA-60 (** = 130-175)
54 cells: PLM-***MB-54 (** = 185-285)	54 cells: PLM-***PB-54 (** = 180-265)	60 cells: PLM-***MB-60 (** = 130-175)
48 cells: PLM-***M-48 (** = 155-255)	48 cells: PLM-***P-48 (** = 165-235)	54 cells: PLM-***M-54 (** = 120-155)
48 cells: PLM-***MA-48 (** = 155-255)	48 cells: PLM-***PA-48 (** = 165-235)	54 cells: PLM-***MA-54 (** = 120-155)
48 cells: PLM-***MB-48 (** = 155-255)	48 cells: PLM-***PB-48 (** = 165-235)	54 cells: PLM-***MB-54 (** = 120-155)
36 cells: PLM-***M-36 (** = 125-190)	36 cells: PLM-***P-36 (** = 125-175)	48 cells: PLM-***M-48 (** = 105-140)
36 cells: PLM-***MA-36 (** = 125-190)	36 cells: PLM-***PA-36 (** = 125-175)	48 cells: PLM-***MA-48 (** = 105-140)
36 cells: PLM-***MB-36 (** = 125-190)	36 cells: PLM-***PB-36 (** = 125-175)	48 cells: PLM-***MB-48 (** = 105-140)
24 cells: PLM-***M-24 (** = 80-125)	24 cells: PLM-***P-24 (** = 80-115)	36 cells: PLM-***M-36 (** = 80-105)
24 cells: PLM-***MA-24 (** = 80-125)	24 cells: PLM-***PA-24 (** = 80-115)	36 cells: PLM-***MA-36 (** = 80-105)
24 cells: PLM-***MB-24 (** = 80-125)	24 cells: PLM-***PB-24 (** = 80-115)	36 cells: PLM-***MB-36 (** = 80-105)
		24 cells: PLM-***M-24 (** = 55-70)
		24 cells: PLM-***MA-24 (** = 55-70)

For the modules listed above ** represents module Wp in increments of 5W of figures shown.

Mini Panels with Sliced 6" Mono-crystalline Cells:	Mini Panels with Sliced 5" Mono-crystalline Cells:	Mini Panels with Sliced 6" Poly-crystalline Cells:
36 cells: PLM-***M-36 (** = 5, 10, 20, 30, 40, 50, 60, 70, 80, 100, 120)	36 cells: PLM-***M-36 (** = 5,10, 50)	36 cells: PLM-***P-36 (** = 5, 10, 20, 30, 40, 50, 60, 70, 80, 100, 120)
36 cells: PLM-***MA-36 (** = 5, 10, 20, 30, 40, 50, 60, 70, 80, 100, 120)	36 cells: PLM-***MA-36 (** = 5,10, 50)	36 cells: PLM-***PA-36 (** = 5, 10, 20, 30, 40, 50, 60, 70, 80, 100, 120)

For Mini Panels listed above ** represents Wp stated.



4. Warning and Notes



Warning

Perlight Solar modules generate electricity when exposed to light. An array of modules can cause lethal shock and burn hazards. Only authorized and trained personnel should have access to the PV modules. To reduce the risk of electrical shock or burns, modules may be covered with an opaque material during installation. Do not touch live terminals with bare hands. Use insulated tools for electrical connections.

Each Perlight Solar module has a pair of male and female waterproof connectors. For a series electrical connection, connect positive (+) connector of first solar module to negative (-) connector of the following module.

Do not short the positive and the negative. Do not disconnect under load. Ensure each connection is sound with no gap between the insulators. Poor connections may cause arcing and pose a fire and/or an electrical shock hazard.

Artificially concentrated sunlight shall not be directed on the Perlight Solar module. The electrical characteristics are the indicated value of P_{max} under standard test conditions (Irradiance of $1000W/m^2$, AM 1.5 spectrum, and cell temperature of $25^{\circ}C$).

Under normal conditions, a solar PV module is likely to experience conditions that produce more current and/or voltage than reported at standard test conditions. Accordingly the value of I_{sc} and V_{oc} marked on this module should be multiplied by a factor of 1.25 when determining component voltage ratings, conductor current ratings, fuse sizes, and sizes of controls connected to the Perlight Solar PV module output. Refer to local and national Electrical Code for any additional multiplying factors, which may also be applicable.

Handle with care

Unpack and handle the PV modules with care. For safety always avoid installing PV modules during wet and windy conditions or during electrical storms.

- Do not place heavy objects on to the PV modules.
- Do not step or walk on the module, although Perlight Solar modules are rugged, flexing caused by bodyweight on the module face can create micro-cracks in the solar cells, which may not be visible but will effect cell performance as the module ages. Take care not to impact the module during installation, module glass can be broken (and the module will no longer work properly) if it is dropped or hit by tools or other objects.
- Take care not to allow the front glass or backsheet of the module come into contact with hard or sharp surfaces such as scaffold during the installation process to avoid scratching or damaging the PV module.
- Do not scratch the PV module backsheet.
- Do not drill or cut the PV module frame.
- Do not apply paint or glue to the PV module.



5. Permit

Before installing your system, contact local authorities to determine the necessary permit, installation and inspection requirements.

6. Climate Conditions

Install the Perlight Solar PV modules in the following conditions:

- Ambient temperature: -20°C to +40°C.
- Operating temperature: -40°C to +85°C.
- Storage temperature: -40°C to +40°C
- Humidity: below 85RH%
- Wind pressure: below 50.12lb / ft² (2400Pa)
- Corrosion resistant: Except for corrosive salt areas and sulphurous areas.

7. Module Structure

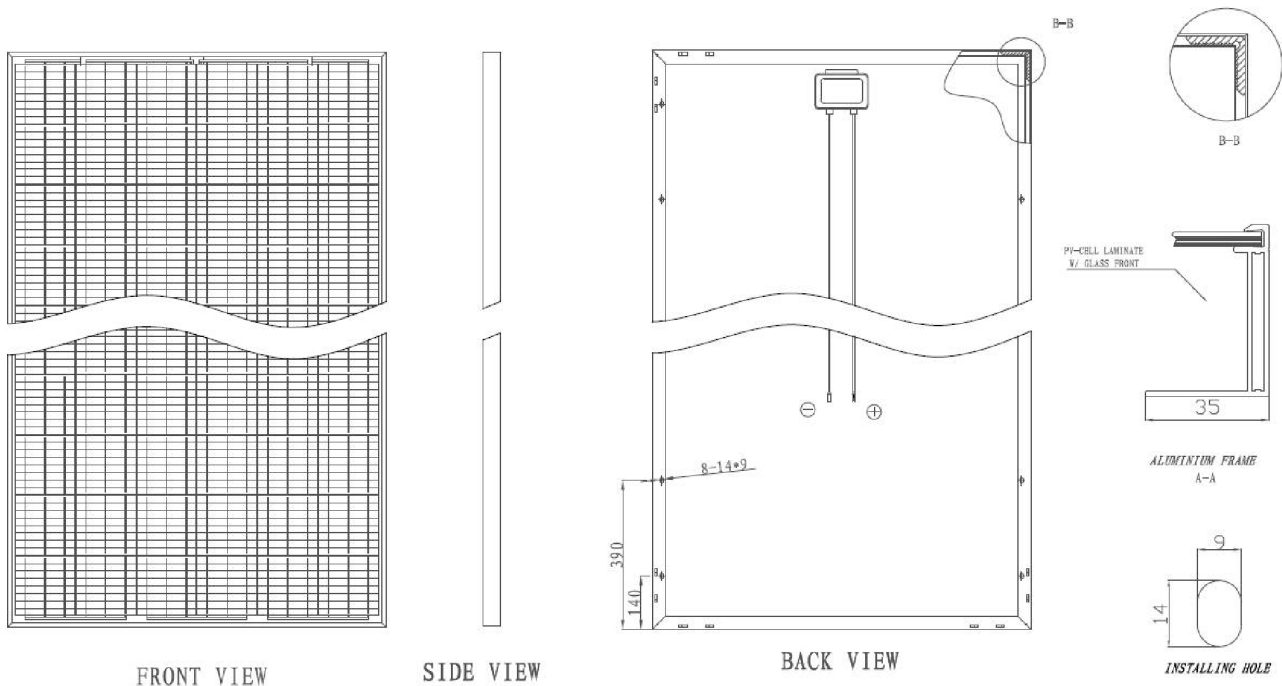

Fig.1: Module Structure



8. Site Selection

In most applications, Perlight Solar modules should be installed in a location where they will receive maximum sunlight throughout the year. In the Northern Hemisphere, the module should typically face south, and in the Southern Hemisphere, the modules should typically face north. Modules facing 30 degrees away from true South (or North) will lose approximately 10 to 15 per cent of their power output. If the module faces 60 degrees away from true South (or North), the power loss will be 20 to 30 percent.

When choosing a site, avoid trees, buildings or obstructions, which could cast shadows on the solar photovoltaic modules especially during the winter months when the arc of the sun is lowest over the horizon. Shading causes loss of output, even though the factory fitted bypass diodes of the Perlight Solar module will minimize any such loss.

Do not install the Perlight Solar module near naked flame or flammable materials. Do not install the Perlight Solar module in a location where it would be immersed in water or continually exposed to water from a sprinkler or fountain etc.

9. Module Tilt Angle

Perlight Solar modules connected in series should be installed at same orientation and angle. Different orientation or angle may cause loss of output power due to difference in amount of sunlight exposed to the module.

Perlight Solar modules produce the most power when they are pointed directly at the sun. For installations where the Perlight Solar modules are attached to a permanent structure, the modules should be tilted for optimum winter performance. As a rule, if the system power production is adequate in winter, it will be satisfactory during the rest of the year. The module tilt angle is measured between the solar modules and the ground (Figure 2). Optimal tilting of Perlight Solar module is almost the same as the latitude of installation location.

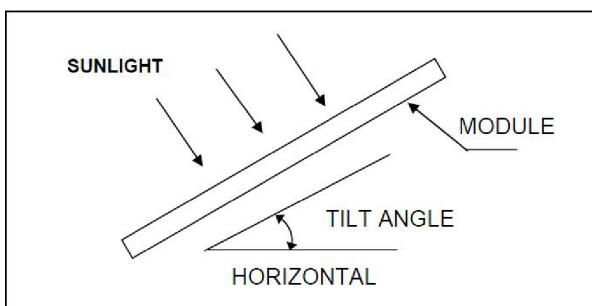

Fig.2: Installation angle

Degrees of Latitude	Tilt Angle
0° ~ 15°	15°
15° ~ 25°	Equal to Latitude
25° ~ 30°	Latitude + 5°
30° ~ 35°	Latitude + 10°
35° ~ 40°	Latitude + 15°
40° +	Latitude + 20°



10. Mounting and Notes

The PV module frame is made of anodized aluminium, and therefore corrosion can occur if the module is subjected to a salt water environment with contact to a rack of another type of metal (Electrolysis Corrosion). If required, PVC, EPDM or stainless steel washers can be placed between the PV module frame and support structure to prevent this type of corrosion. Module support structures that are to be used to support Perlight Solar modules at the correct tilt angles should be wind and snow load rated for use by the appropriate local and civil codes prior to installation.

Perlight Solar modules can be mounted using the following methods:

- Direct fixing to mounting structure
- Suitable module clamps as part of solar mounting system
- Insertion systems
- Roof integrated systems

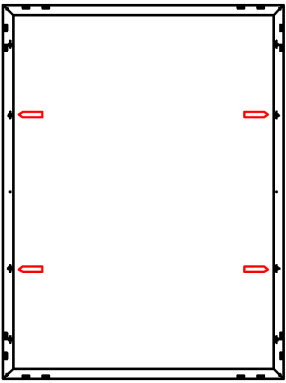
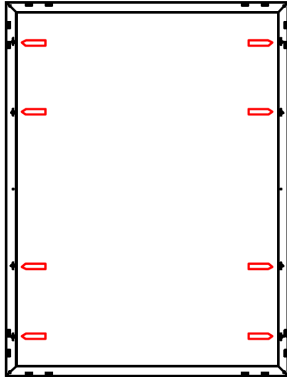
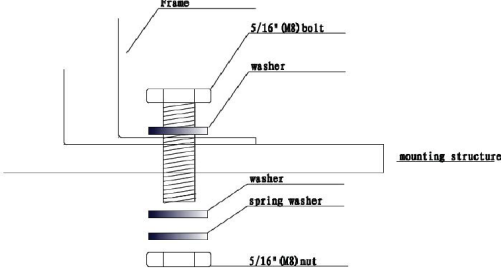
Direct Fixing to Mounting Structure	
2400Pa Wind Load 2400Pa Snow Load	5400Pa Wind Load 3800Pa Snow Load
	
Use Four Mounting Holes	Use Eight Mounting Holes
	<p>Direct Fixing to Mounting Structure</p> <p>The frame of each module has 8 mounting holes (14mm*9mm), which can be used to secure the modules to a supporting structure. The module frame must be attached to a supporting structure using corrosion-proof M8 stainless steel nuts and bolts with spring washers and flat washers in at least four points symmetrical on the PV module. Applied torque is approx. 8 Newton-meters.</p>

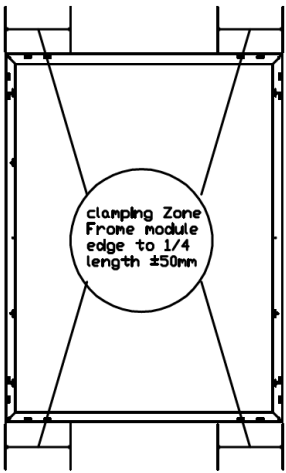
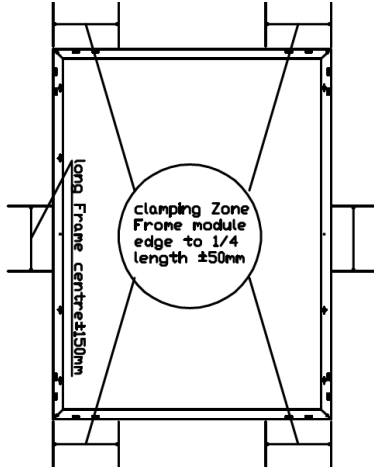
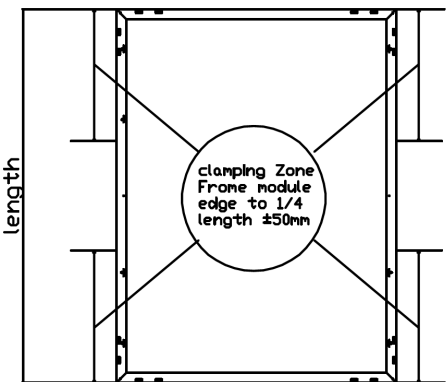
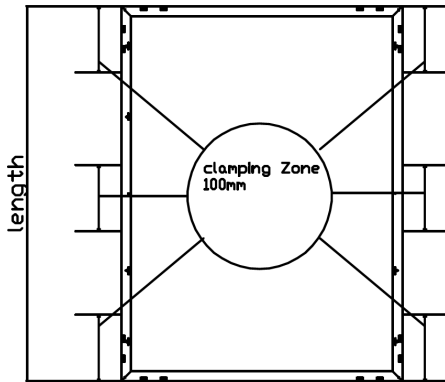

Solar Mounting Systems	
2400Pa Wind Load 2400Pa Snow Load	5400Pa Wind Load 3800Pa Snow Load
 <p style="text-align: center;">clamping Zone From module edge to 1/4 length ±50mm</p> <p style="text-align: center;">Fig.:3 Use Four Clamps</p>	 <p style="text-align: center;">clamping Zone From module edge to 1/4 length ±50mm</p> <p style="text-align: center;">Long Frame center ±150mm</p> <p style="text-align: center;">Fig.: 4 Use Four Clamps on Short Side and Two Clamps on Long Side</p>
 <p style="text-align: center;">clamping Zone From module edge to 1/4 length ±50mm</p> <p style="text-align: center;">length</p> <p style="text-align: center;">Fig.: 5 Use Four Clamps</p>	 <p style="text-align: center;">clamping Zone 100mm</p> <p style="text-align: center;">length</p> <p style="text-align: center;">Fig.:6 Use Six Clamps</p>

Module mounting clamps must not come into contact with the front glass and must not deform the frame. Module clamps should not cause shadowing effects. It is not permitted to modify the module frame under any circumstances. Recommended distance between two modules is 5mm considering linear thermal expansion of the module frames.

Clearance between the module frame and mounting surface may be required to prevent the junction box from touching the surface, and to circulate cooling air around the back of the module.

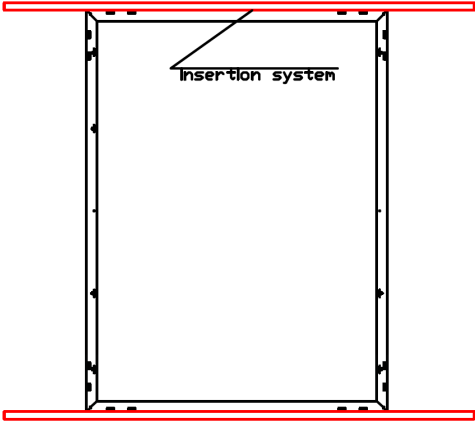
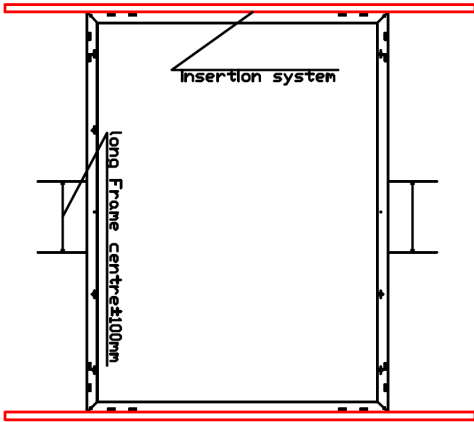
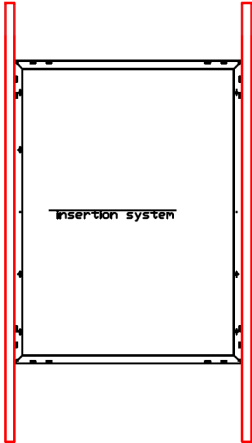

Insertion Mounting Systems	
2400Pa Wind Load 2400Pa Snow Load	5400Pa Wind Load 3800Pa Snow Load
 <p style="text-align: center;">Fig.: 7 Insertion System Short Side</p>	 <p style="text-align: center;">Fig.: 8 Insertion System Short Side and Two Clamps on Long Side.</p>
<p>Insertion Systems must not cause shadowing effects. It is not permitted to modify the module frame under any circumstances. Recommended distance between two modules is 5mm considering linear thermal expansion of the module frames.</p> <p>Clearance between the module frame and mounting surface may be required to prevent the junction box from touching the surface, and to circulate cooling air around the back of the module.</p>	 <p style="text-align: center;">Fig.: 9 Insertion System Long Side</p>

Mounting design may have an impact on fire resistance. If the modules are to be installed on the roof or wall of a building, using an integrated mounting system, the fire resistance of roof covering or wall should be rated for the application and certified for use to local and national standards. Here the stand-off method or the rack method is recommended. The modules are supported parallel to the surface of the building wall or roof. Clearance between the module frames and surface of the wall or roof is required to prevent wiring damage and to allow air to circulate behind the module. The recommended stand-off height is 115mm. Any slope less than 5in/ft (127mm/305mm) is required to maintain a fire class rating. Do not mount Perlight Solar module in such way that the drain holes of the module are intended to block up. Roof-integrated (in-roof) systems must comply with local and national regulations, including fire test certification where necessary.



11. Grounding

All module frames and mounting racks must be properly grounded in accordance with local and national electrical regulations. Proper grounding is achieved by connecting the module frame(s) and structural members continuously one to another using a suitable grounding conductor. The grounding conductor or strap may be copper, copper alloy, or other material acceptable for use as an electrical conductor as per local and national guidelines. The grounding conductor must then make a connection to earth using a suitable earth ground electrode.

Attach a separate conductor to one of the marked 4mm diameter grounding holes on the module frame with a bolt and nut that incorporates an external tooth washer. This is to ensure positive electrical contact with the frame.

The rack must also be grounded unless they are mechanically connected by nuts and bolts to the grounded Perlight Solar modules. The array frame shall be grounded in accordance with local and national guidelines.

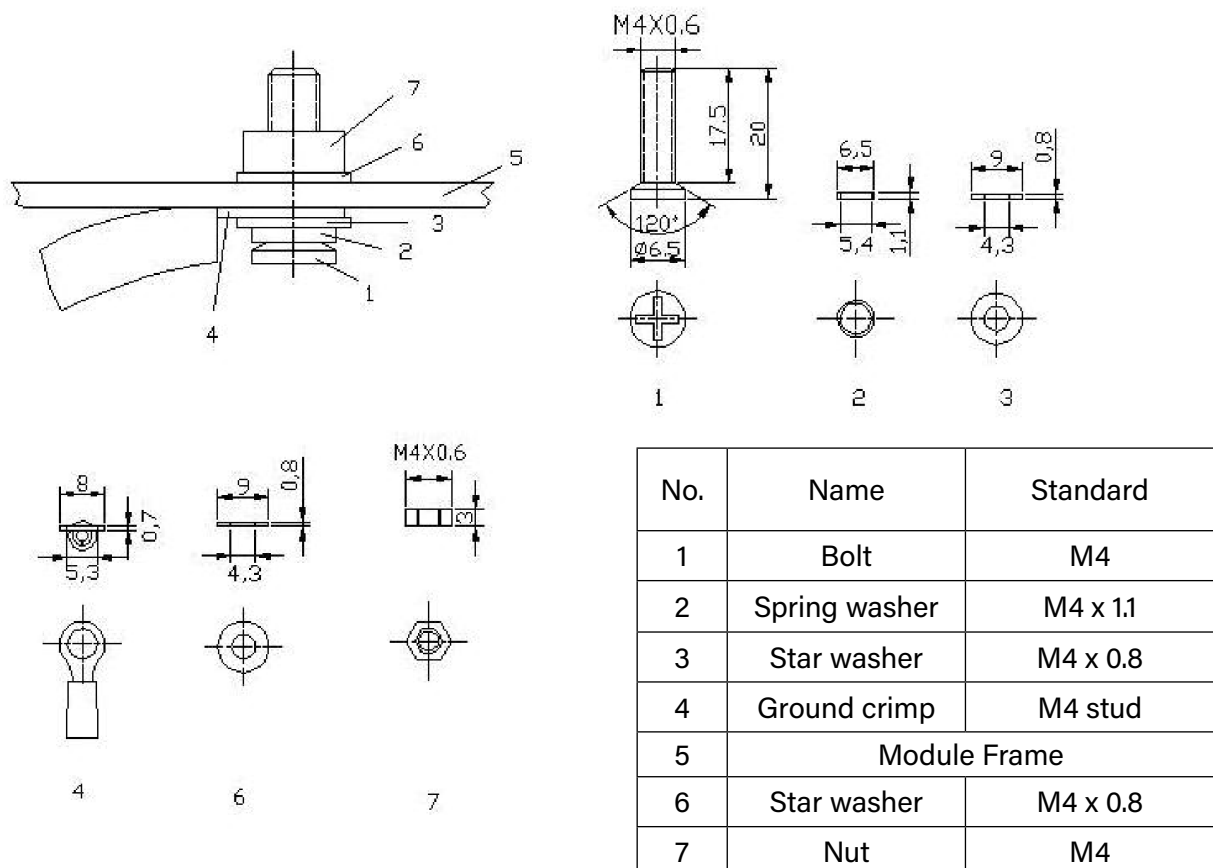

Fig.10: Grounding crimp and washer sizes



12. Module Wiring

Each solar module is wired with three separate series cell strings.

Bypass Diodes

Bypass diodes are wired in parallel with the series cell strings to prevent hot spot heating caused by individual cell reverse bias that occurs when a module is partially shaded.

Output Cables

Each module has two standard 90°C rated, water-proof, UV resistant output cables each terminated with plug & play connectors. This cable is suitable for applications where wiring is exposed to the direct rays of the Sun.

Field connections

Connecting cables should be a minimum of 12 AWG copper cables, which are UV resistant and insulated for a minimum of 90°C. All wiring and electrical connections must comply with local and national Electrical Code.

Blocking Diodes

In a system utilizing a battery, blocking diodes are typically placed between the battery and the solar module output to prevent battery discharge at night. Diodes that are used as blocking diodes must: Have a Rated Average Forward Current [$I_{F(AV)}$] above maximum system current at highest module operating temperature. Have a Rated Repetitive Peak Reverse Voltage [V_{RRM}] above maximum system voltage at lowest module operating temperature.



13. Maintenance

Cleaning

Under most weather conditions, normal rainfall is sufficient to keep the Perlight Solar module glass surface clean. If dirt build-up becomes excessive, clean the glass only with a soft cloth using mild detergent and water. **USE CAUTION WHEN CLEANING THE BACK SURFACE OF THE MODULE TO AVOID PENETRATING THE SUBSTRATE MATERIALS.** Solar Modules that are mounted flat (0° tilt angle) should be cleaned more often, as they will not “self clean” as effectively as modules mounted at a 15° tilt or greater. Perlight recommend cleaning the modules during the early morning or evening, when the panels will be operating at a lower temperature and producing little energy.

- Do not lean or stand on the modules during cleaning.
- Do not use high pressure water jets to clean the solar modules.

Annual Checks

Once a year, check the tightness of terminal screws and the general condition of the wiring. Also, check to ensure the mounting hardware is tight and secure. Loose connections will result in damage to the array.

Changed Perlight Solar modules must be of the same kind and type. Do not touch live parts of cables and connectors. Use appropriate safety equipment when working (insulated tools, insulating gloves, etc.).



Warning

Only trained personnel may carry-out repair work to the PV modules and system components.

Cover the front surface of the solar module with an opaque or other material when working on the modules. Solar modules generate high voltage when exposed to sunlight.



14. Recycling

Perlight work to avoid unnecessary waste, keeping module packaging to a minimum, while maintaining the protection of the modules during transport.

Please recycle the cardboard and paper packaging in accordance with local guidelines and regulations.

End of Life Disposal and Recycling

Perlight solar modules are designed to produce electricity for a minimum of 25 years, however the panels may continue to offer useful energy for years to come after this point. Once the panels reach the end of their useful life, they should be recycled in accordance with local guidelines and regulations.

Within the European Union, solar modules are subject to Waste Electrical and Electronic Equipment (WEEE) regulations. The WEEE symbol is displayed on every module nameplate label at the rear of the panel. This means that this product shall not be treated as household waste and must be disposed of at an appropriate collection point.

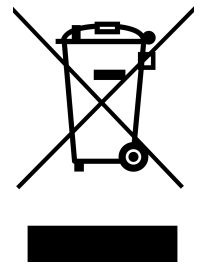

Fig.11: WEEE Symbol

Perlight Solar Co.,Ltd.

Address:
Oufeng Road,
Muyu, Zeguo Town,
Wenling City,
Zhejiang Province,
317521, China

Tel: 0086-576-86477920
www.perlight.com
enquiry@perlight.com