

We support PV systems

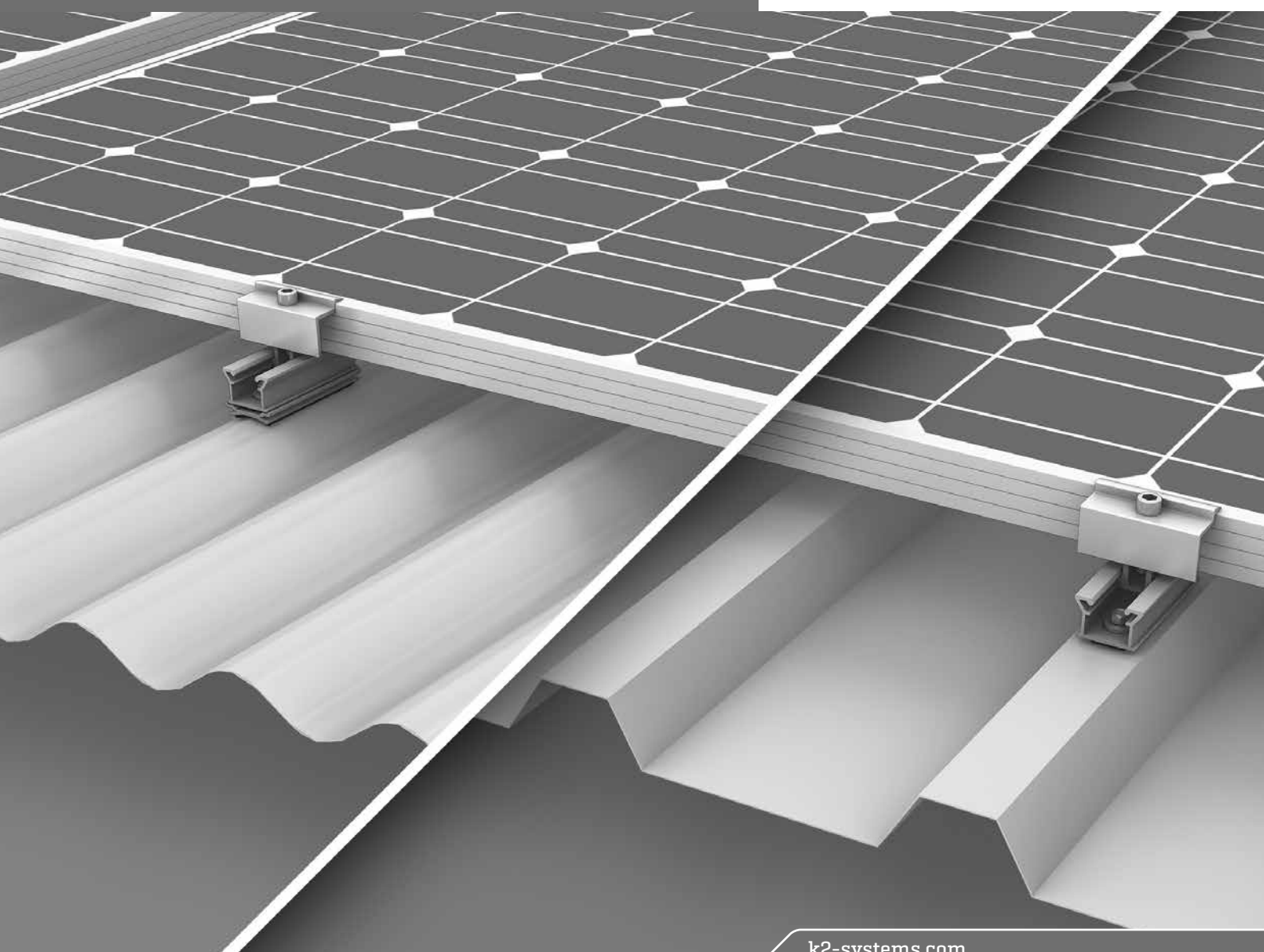

MicroRail System

ASSEMBLY INSTRUCTIONS



Content

▶ Tools overview	3
▶ General safety information	4
▶ The following guidelines apply	5
· Roof requirements	5
· Structural requirements	5
· Important mounting instructions	5
▶ Components	6
· Corrugated sheet assembly	6
· Trapezoidal sheet assembly	8
▶ Assembly	10
· Corrugated sheet	10
· Trapezoidal sheet	14
▶ Module frame grounding	18
▶ Notes	19

Quality tested – several certifications

K2 Systems stands for secure connections, highest quality and precision. Our customers and business partners have known that for a long time. Independent institutes have tested, confirmed and certified our capabilities and components.

Please find our quality and product certificates under:
k2-systems.com/en/technical-information

Tools overview

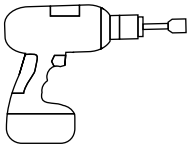

6 mm



8 mm



6 - 35 Nm
[4.5 - 22.2 lb-ft]



6 mm

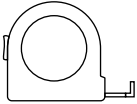

≥ 3.0 m



≥ 6.0 m

General safety information

Please note that our general mounting instructions must be followed at all times and can be viewed online at k2-systems.com/en/technical-information

- ▶ The equipment may only be installed and operated by qualified and adequately trained installers.
- ▶ Prior to installation, ensure that the product complies with on-site static loading requirements. For roof-mounted systems, the roof load-bearing capacity must always be checked.
- ▶ National and local building regulations and environmental requirements must be adhered to.
- ▶ Compliance with health and safety regulations, accident prevention guidelines and applicable standards is required.
 - Protective equipment such as safety helmet, boots and gloves must be worn.
 - Roofing works must be in accordance with roofing regulations utilising fall protection safeguards when eaves height exceeds 3 m.
 - At least two people must be present for the duration of the installation work in order to provide rapid assistance in the event of an emergency.
- ▶ K2 mounting systems are continuously developed and improved and the installation process may thereby change at any time. Prior to installation consult our website at www.k2-systems.com/en/technical-information for up-to-date instructions. We can send you the latest version on request.
- ▶ The assembly instructions of the module manufacturer must be adhered to.
- ▶ Equipotential bonding/grounding/earthing between individual parts is to be performed according to country specific standards, as well as national laws and regulations.
- ▶ At least one copy of the assembly instructions should be available on site throughout the duration of the installation.
- ▶ Failure to adhere to our general safety and assembly instructions and not using all system components, K2 is not liable for any resulting defects or damages. We do not accept liability for any damage resulting in the use of competitor's parts. Warranty is excluded in such cases.
- ▶ German law shall apply excluding the UN Convention on CISG. Place of venue is Stuttgart. Our General Terms of Business apply.
- ▶ If all safety instructions are adhered to and the system is correctly installed, there is a product warranty entitlement of 12 years! We strongly recommend reviewing our terms of guarantee, which can be viewed at www.k2-systems.com/en/technical-information We will also send this information on request.
- ▶ Dismantling of the system is performed in reverse order to the assembly.
- ▶ K2 stainless steel components are available in different corrosion resistance classes. Each structure or component must be carefully checked for possible corrosion exposure.

The following guidelines apply

The MicroRail system can be installed as standard under the following conditions. Even if the system is capable of meeting higher demands through the integration of safety standards, please get in touch with your contact at K2 Systems if the specified values are exceeded.



Roof requirements

- ▶ The sufficient holding force of the roof covering at the support or substructure must be ensured on site.
- ▶ Roof pitch: 5 - 75°
- ▶ Thickness corrugated or trapezoidal sheet metal:
≥ 0.4 mm steel and ≥ 0.5 mm aluminium
- ▶ Sheet quality steel at least S235 acc. DIN EN 10025-1
- ▶ Minimum tensile strength for aluminium 165 N/mm²
- ▶ High crest distance ≥ 22 mm, flush area surrounding the bore hole: ≥ 20 mm
- ▶ High crest radius for corrugated sheet:
 $r = 22 - 45 \text{ mm}$



Structural requirements

The static verification of the component is automatically calculated with the K2 Base planning software for the respective location. The design provided in a project report must be followed.



Important mounting instructions

- ▶ On-site general standards and regulations for lightning protection must be observed and consultation with a specialist to create a lightning protection concept is recommended (use lightning protection clamp if necessary). Country-specific regulations must be observed.
- ▶ If the corrugated or trapezoidal sheet is fastened with storm washers, please do not fasten the MicroRails on the storm washers! Spacing must be measured beforehand.
- ▶ Fasten the MicroRail to corrugated or trapezoidal sheets with building approved self-tapping screws.
- ▶ Distance between two assembled vertical rails must be at least 10 mm
- ▶ Horizontal distance (verge-to-verge direction) between the short sides of the modules must be at least 20 mm
- ▶ After 13.60 m (length of the module row in the vertical crest direction) a thermal separation must be installed. For this purpose, two rails must be fixed one behind the other on the same high crest. The distance between the MicroRails must be at least 10 mm.

Components

Corrugated sheet assembly

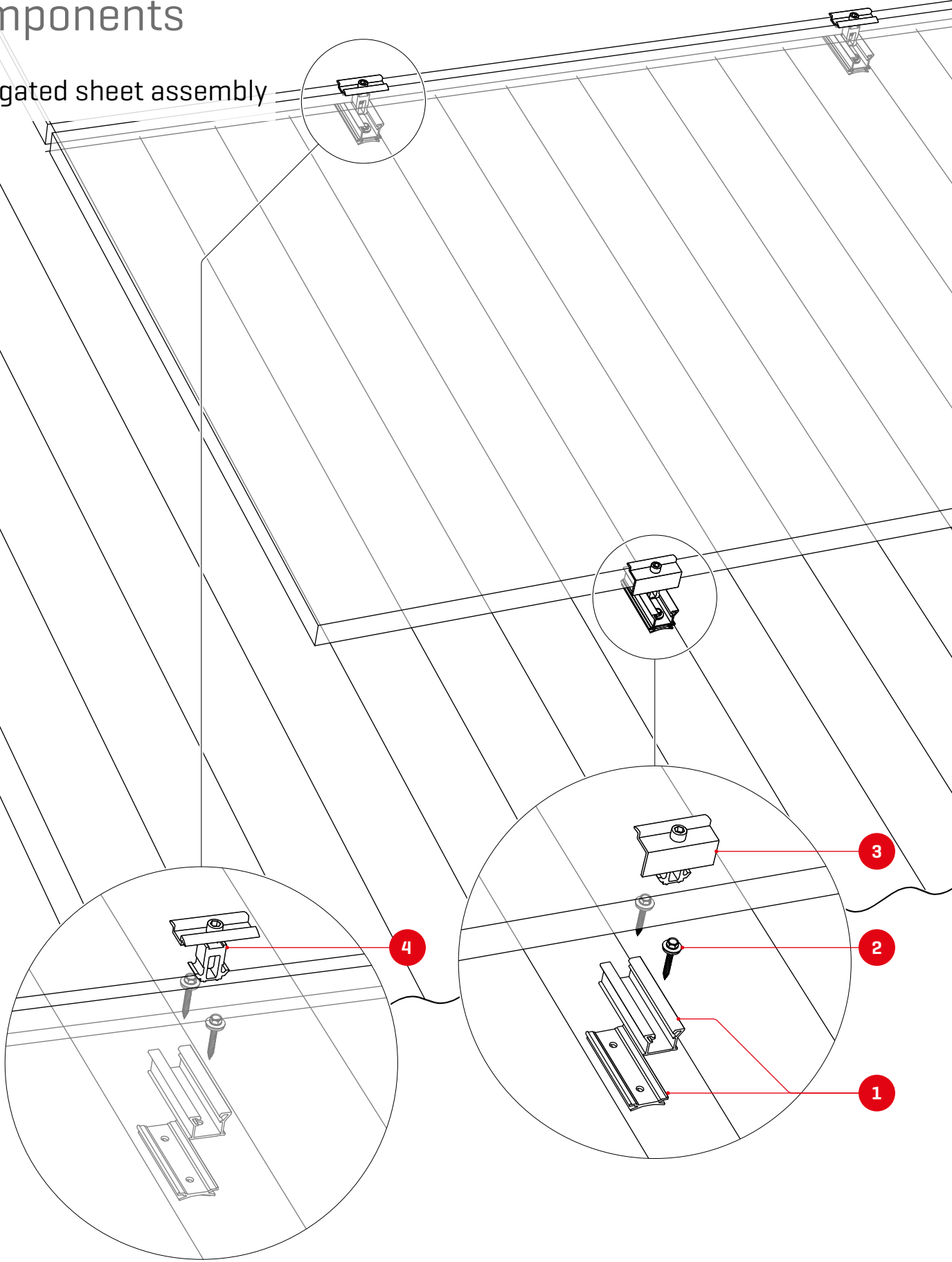

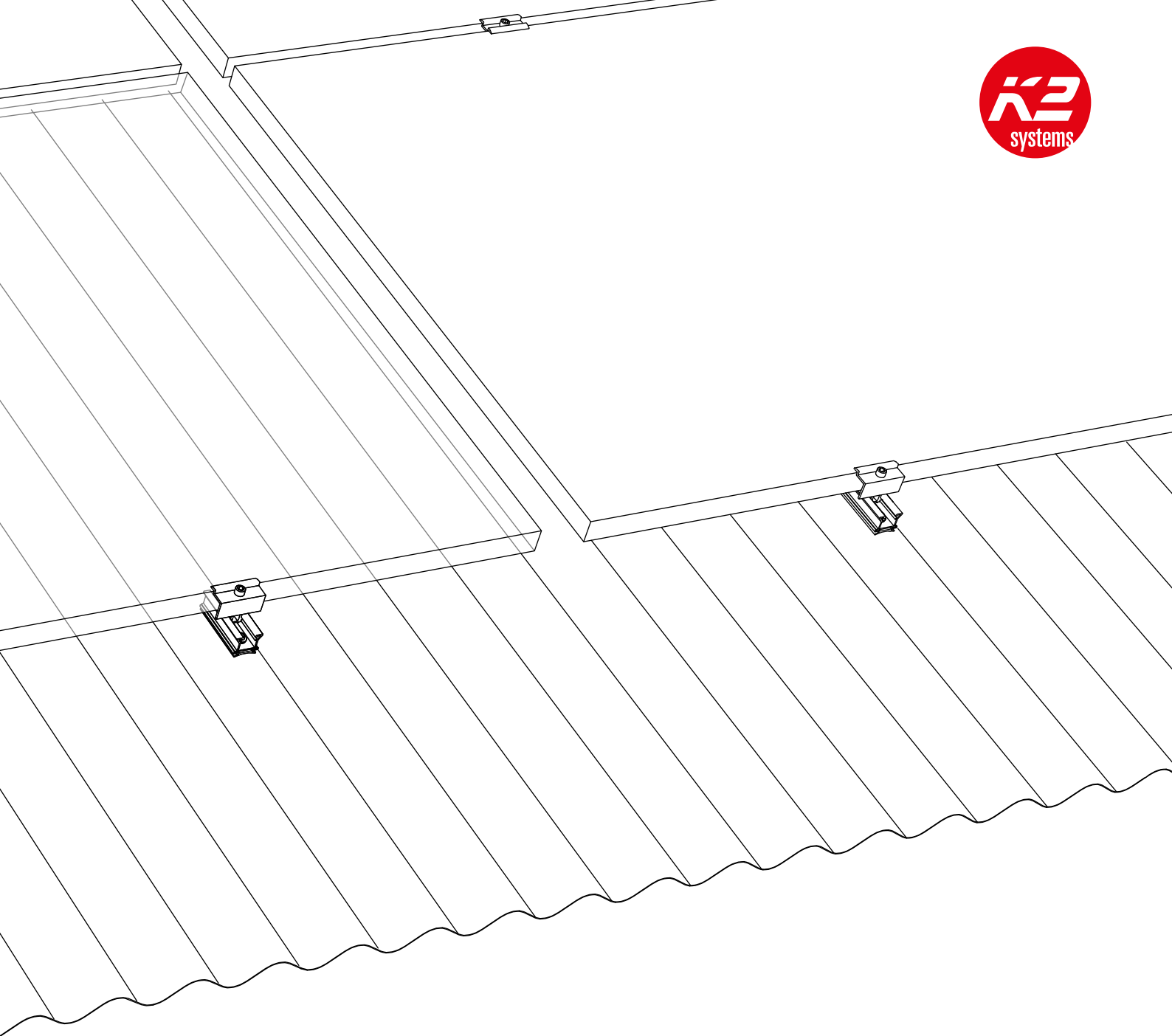

1 2003214 / 2001427

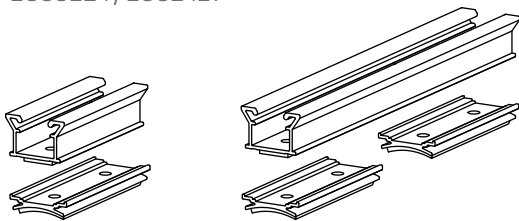

MicroRail CSM 10/25 Set

2 1005193



Self-tapping screw with sealing washer

3 2002559

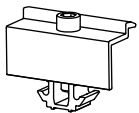

MiniClamp EC
30-50 mm module frame height

4 2002558

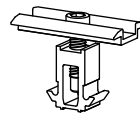

MiniClamp MC
30-50 mm module frame height

Components

Trapezoidal sheet assembly

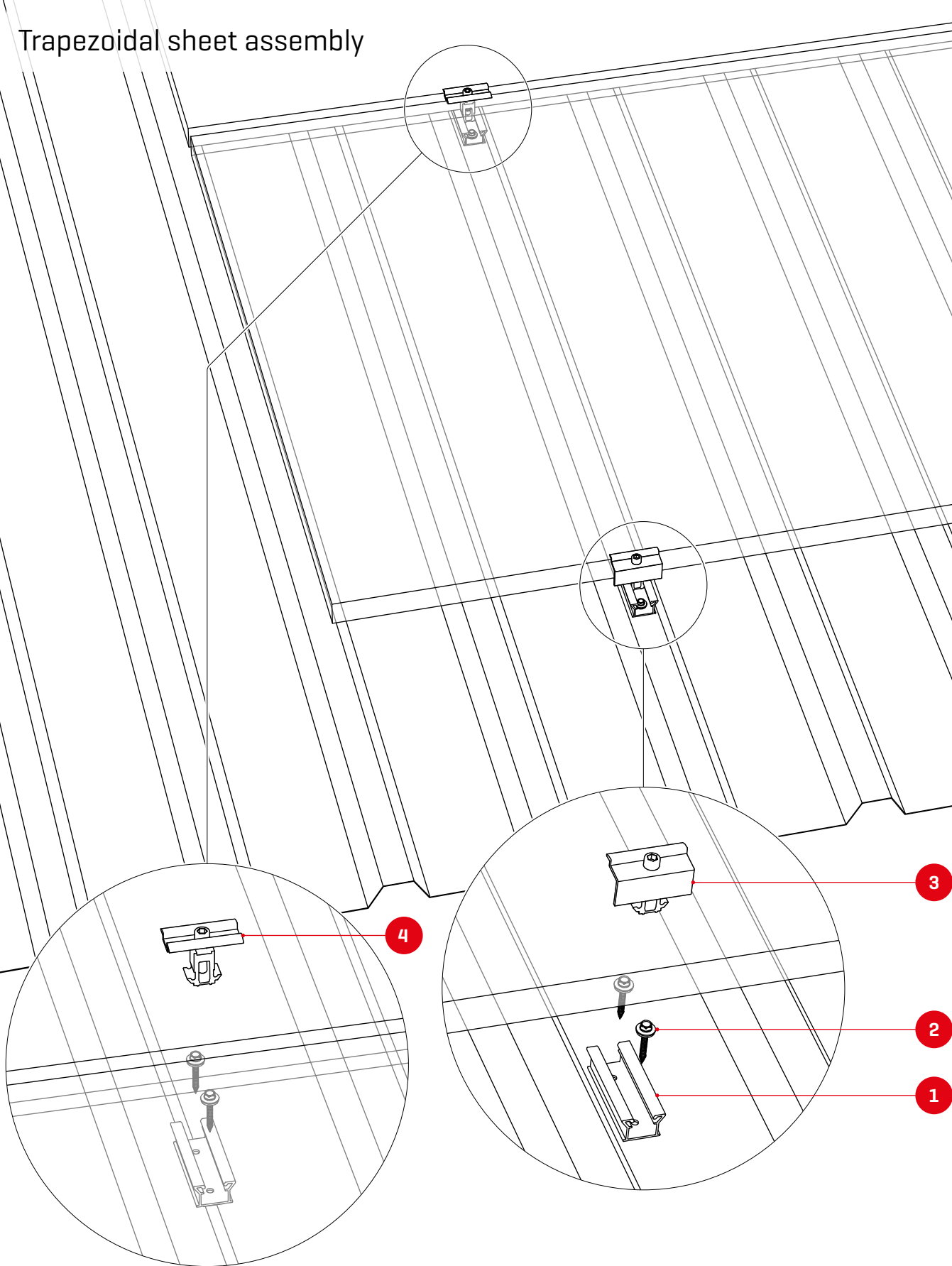

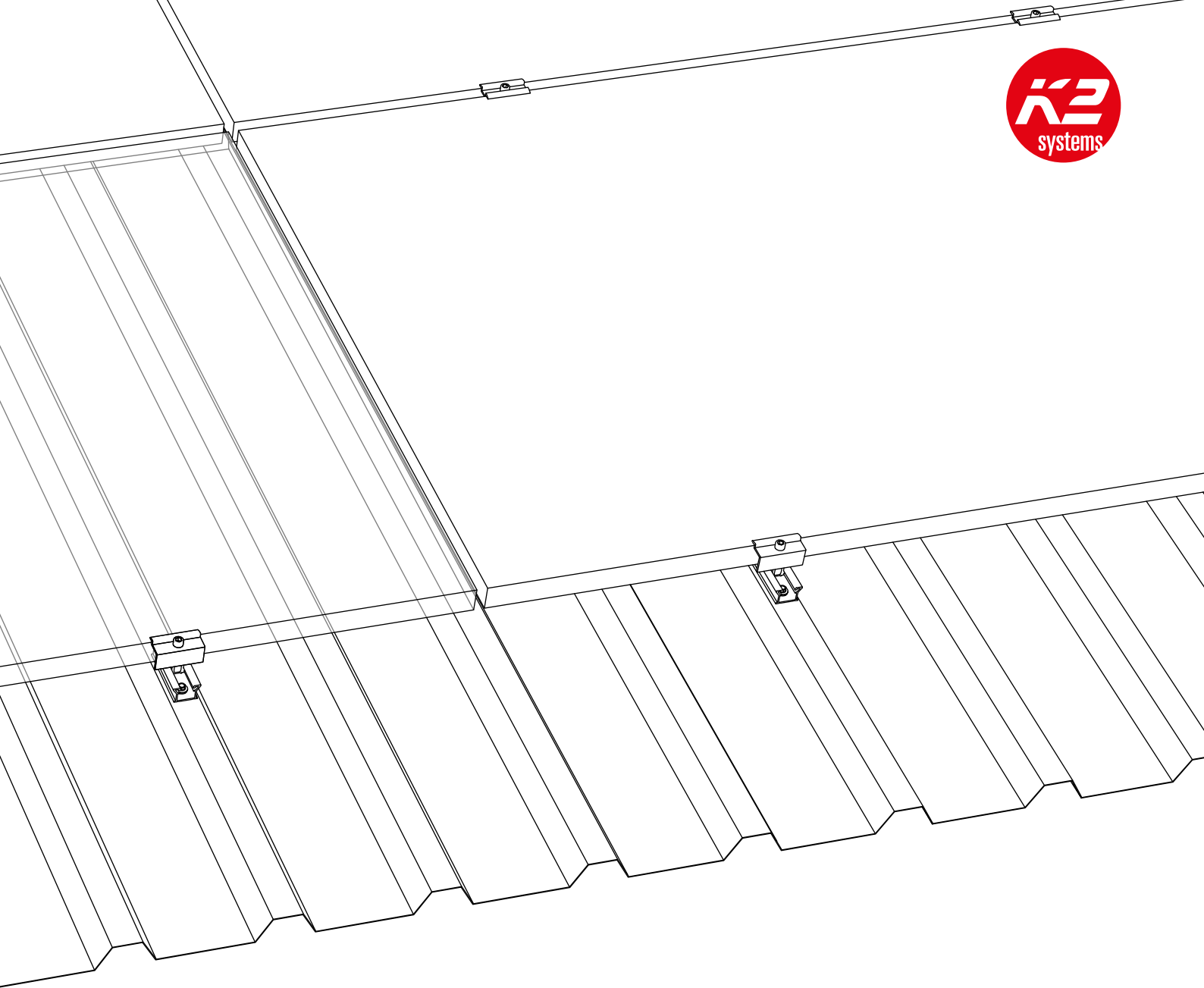

1 2003198 / 2003199

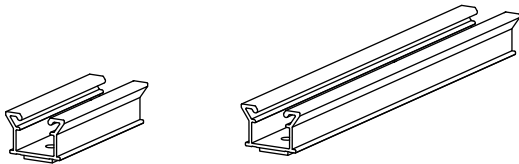

MicroRail 10/25

2 1005193



Self-tapping screw with sealing washer

3 2002559

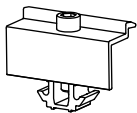

MiniClamp EC
30-50 mm module frame height

4 2002558

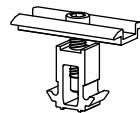

MiniClamp MC
30-50 mm module frame height

Assembly

Corrugated sheet

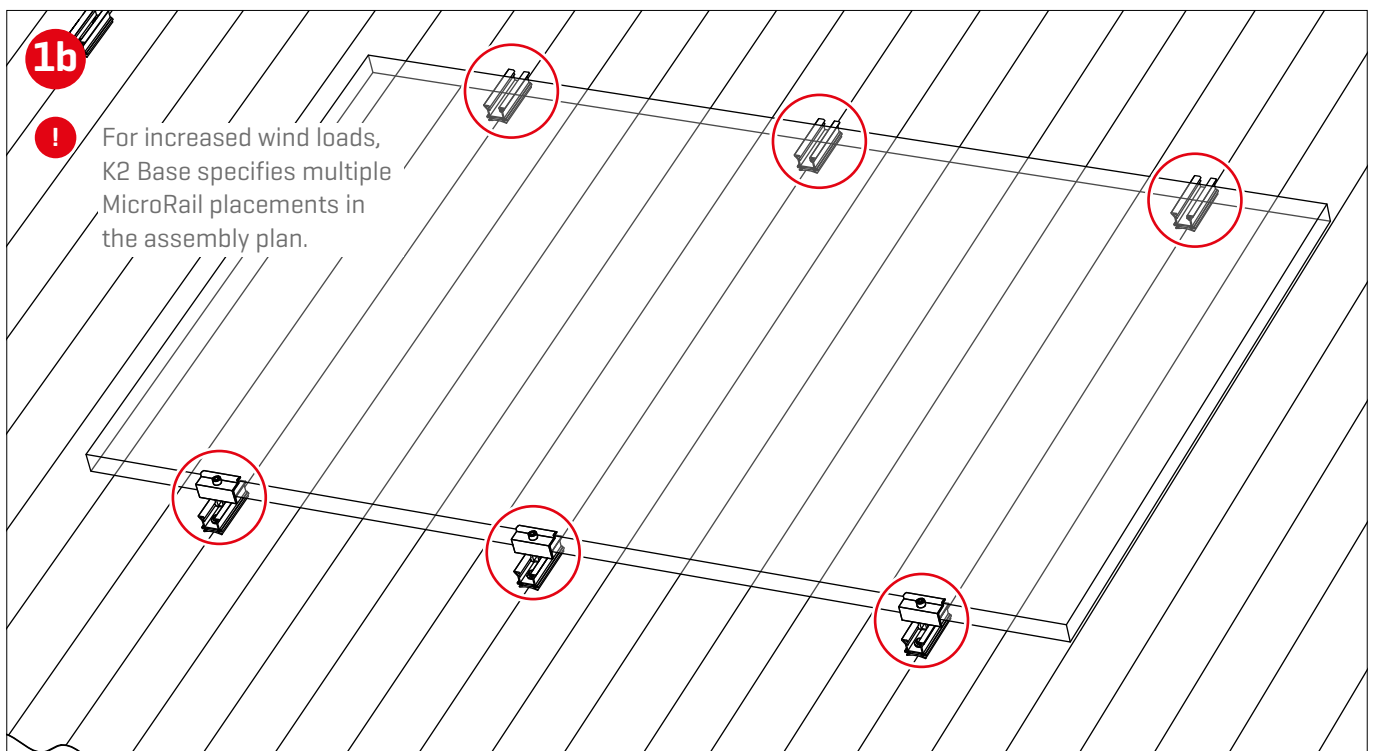
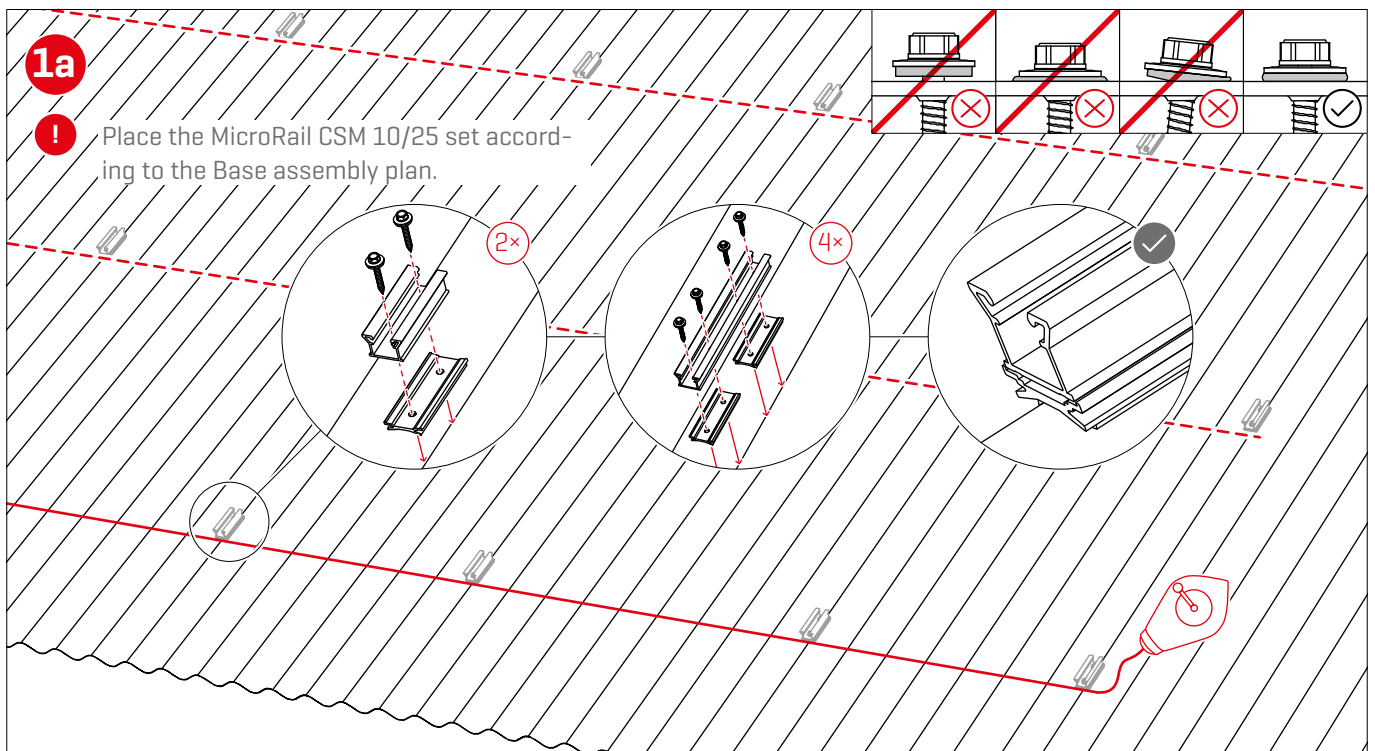

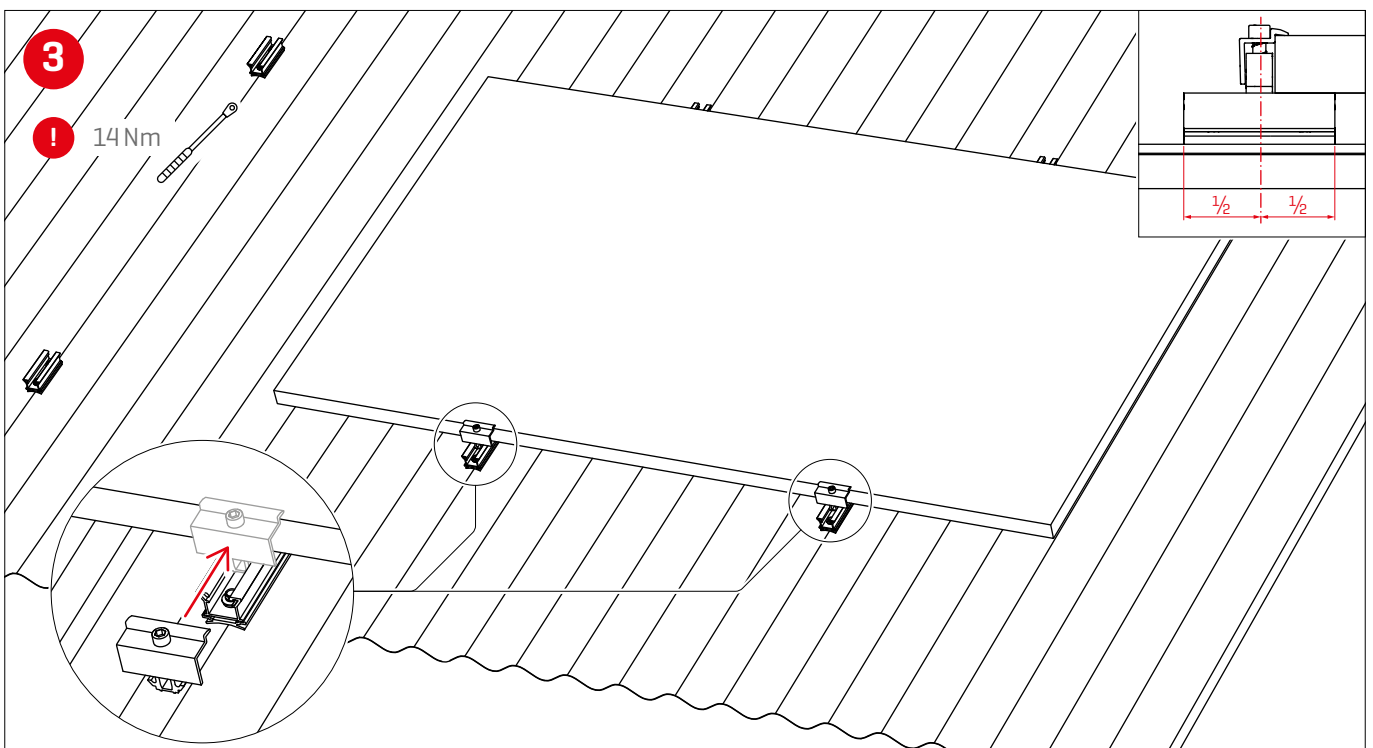
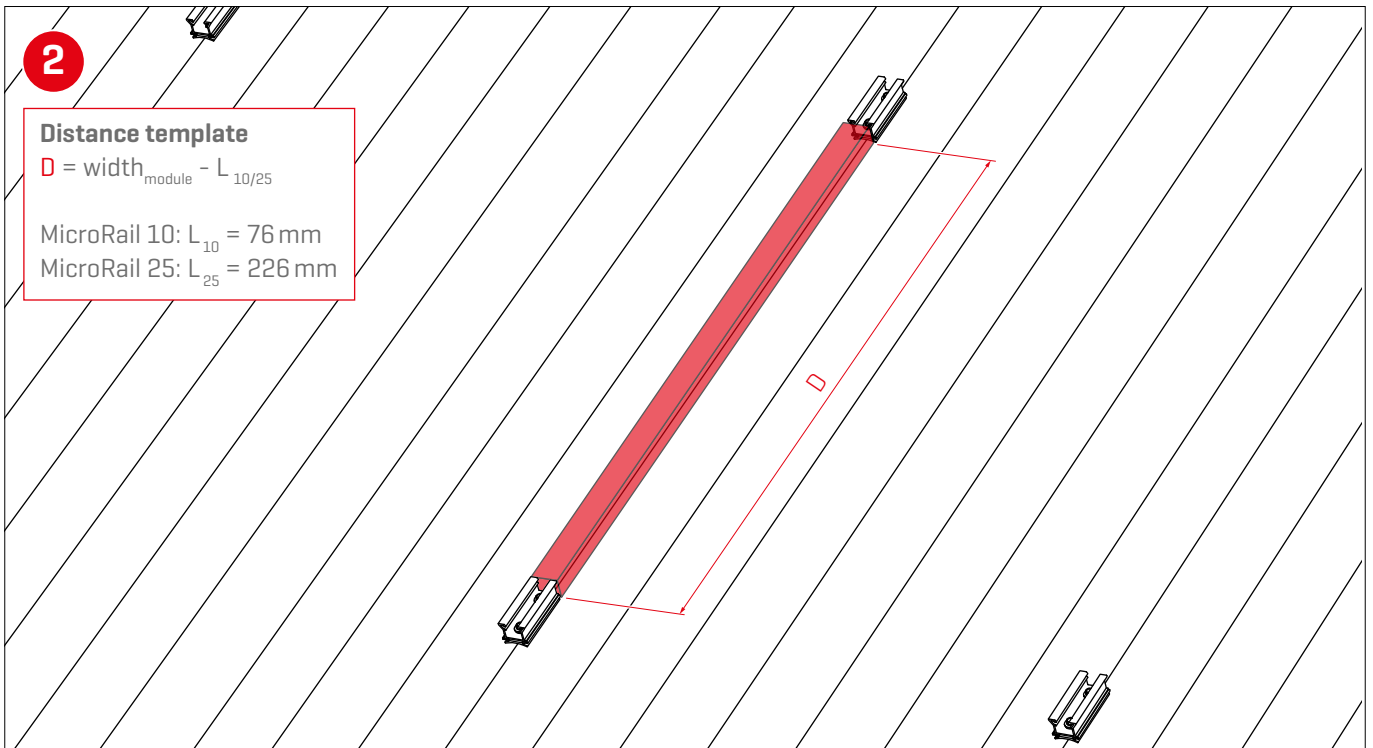

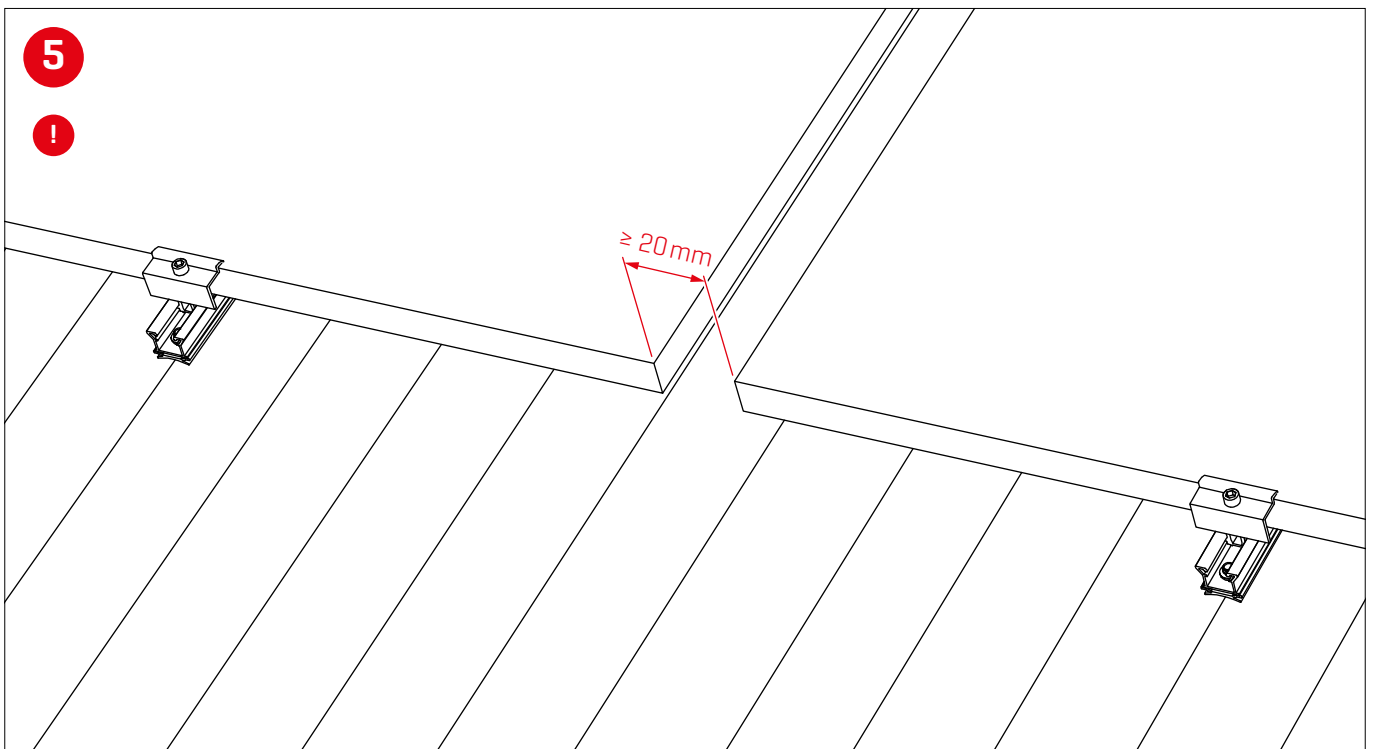
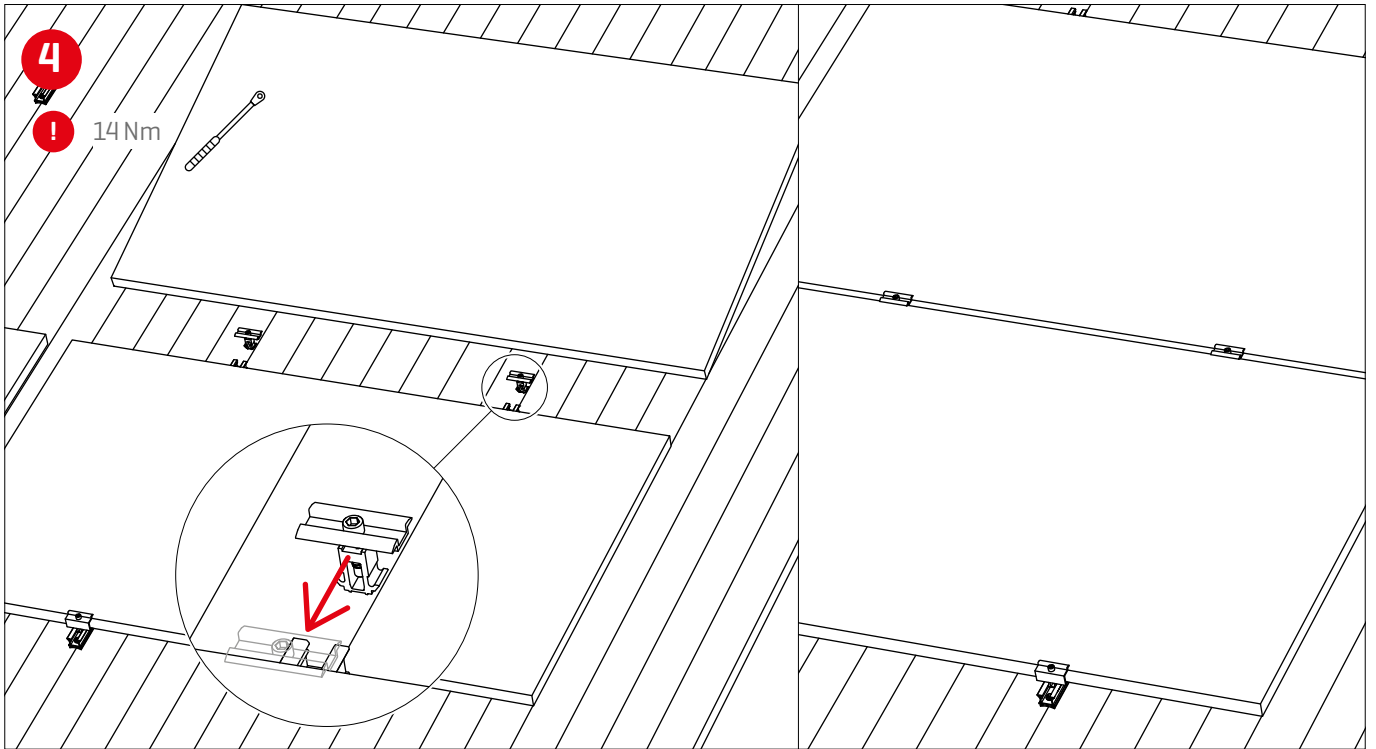

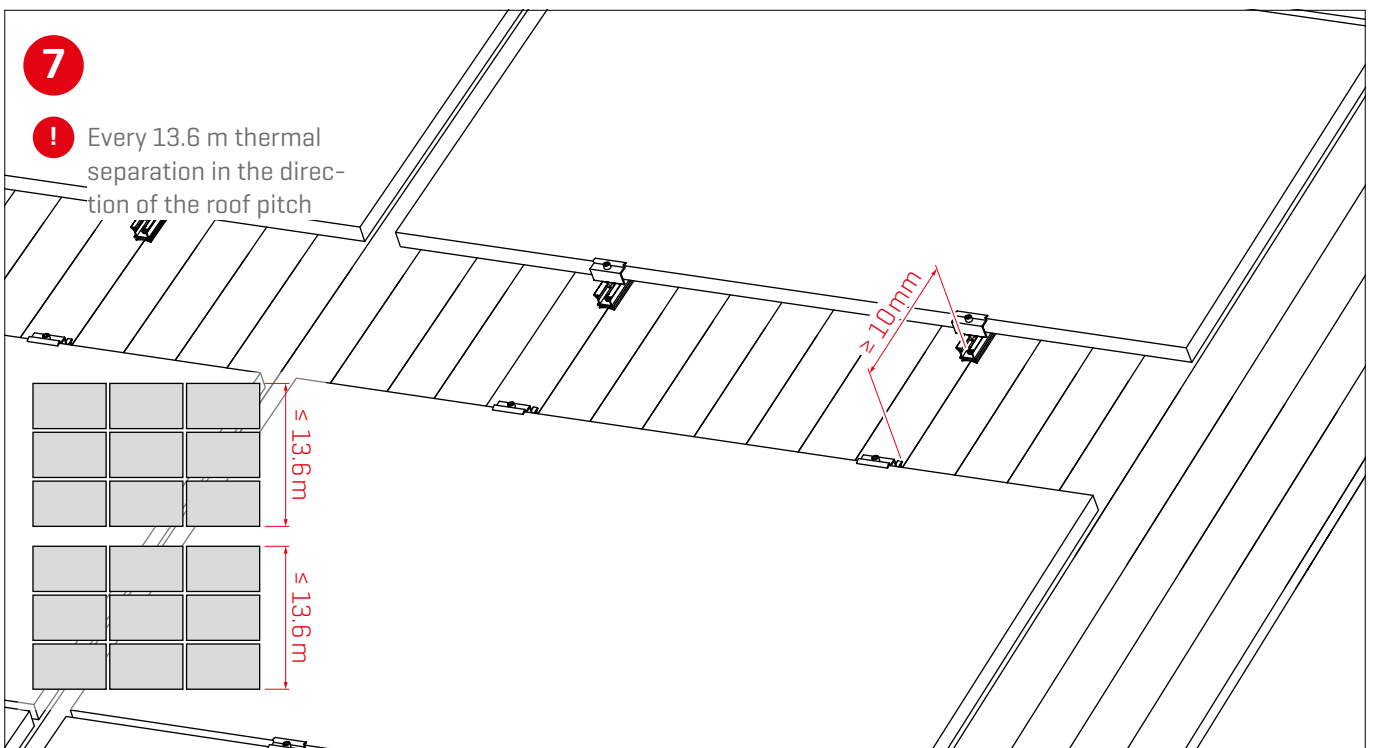
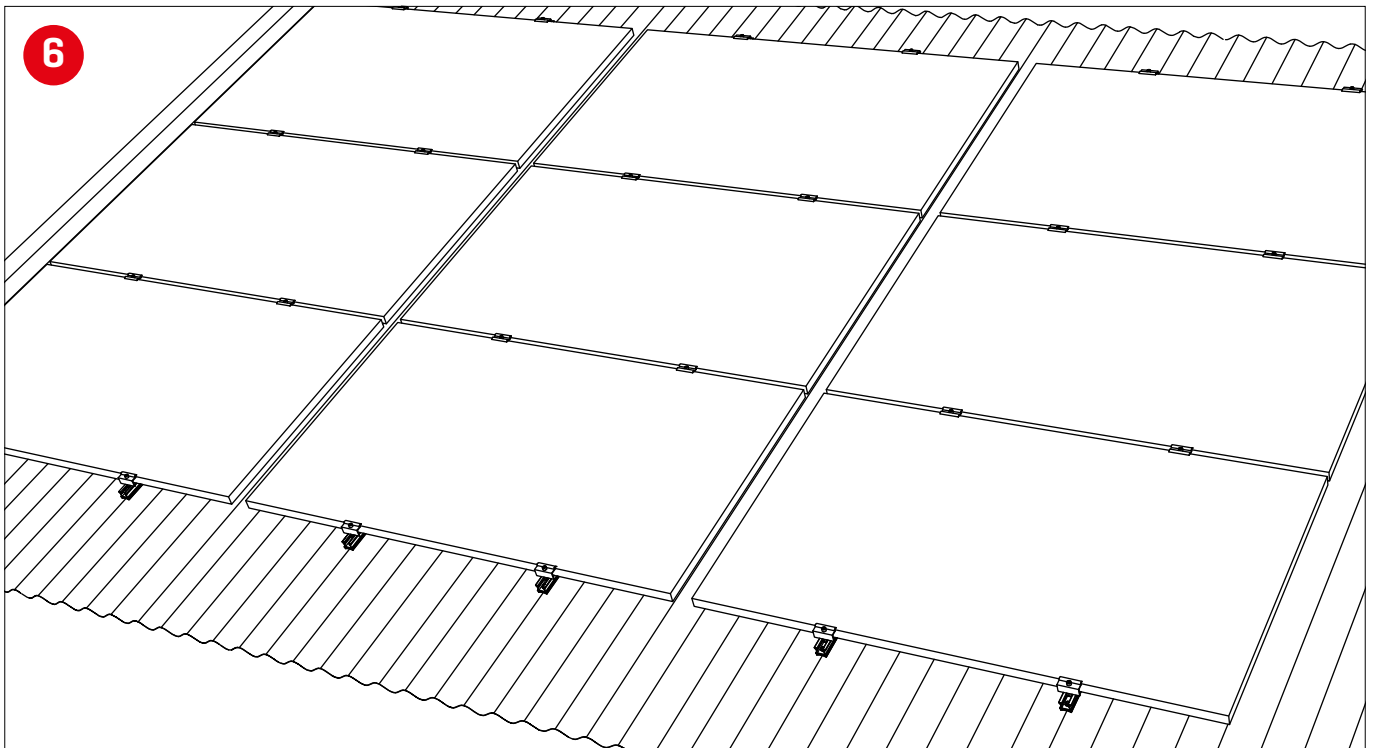

Assembly

Trapezoidal sheet

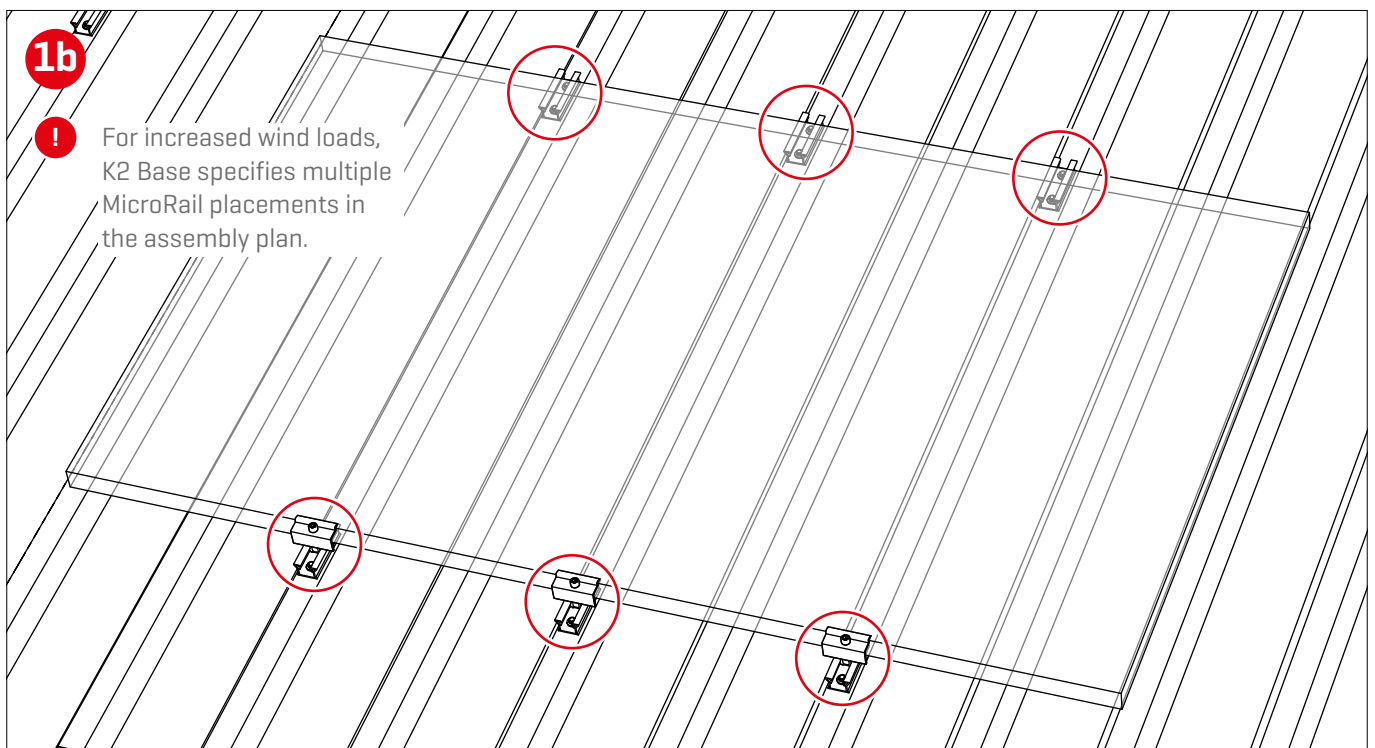
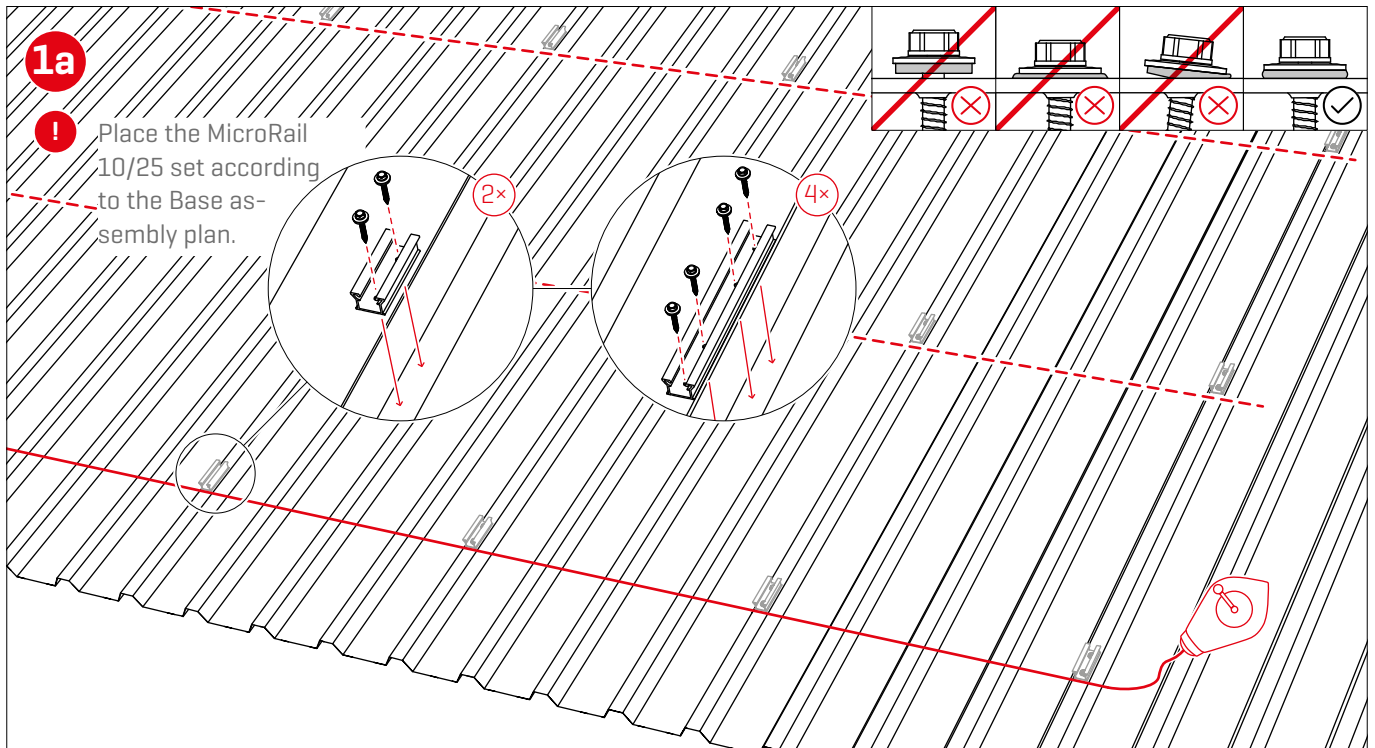

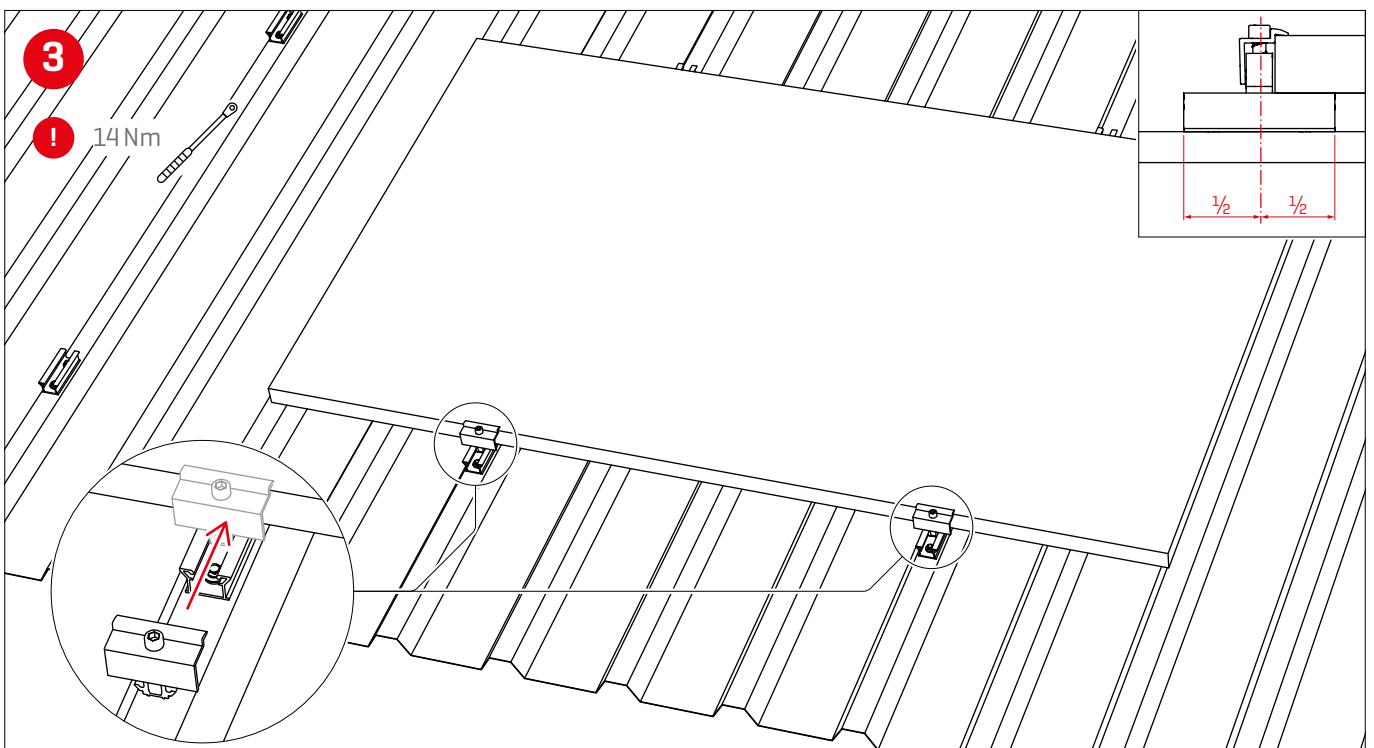
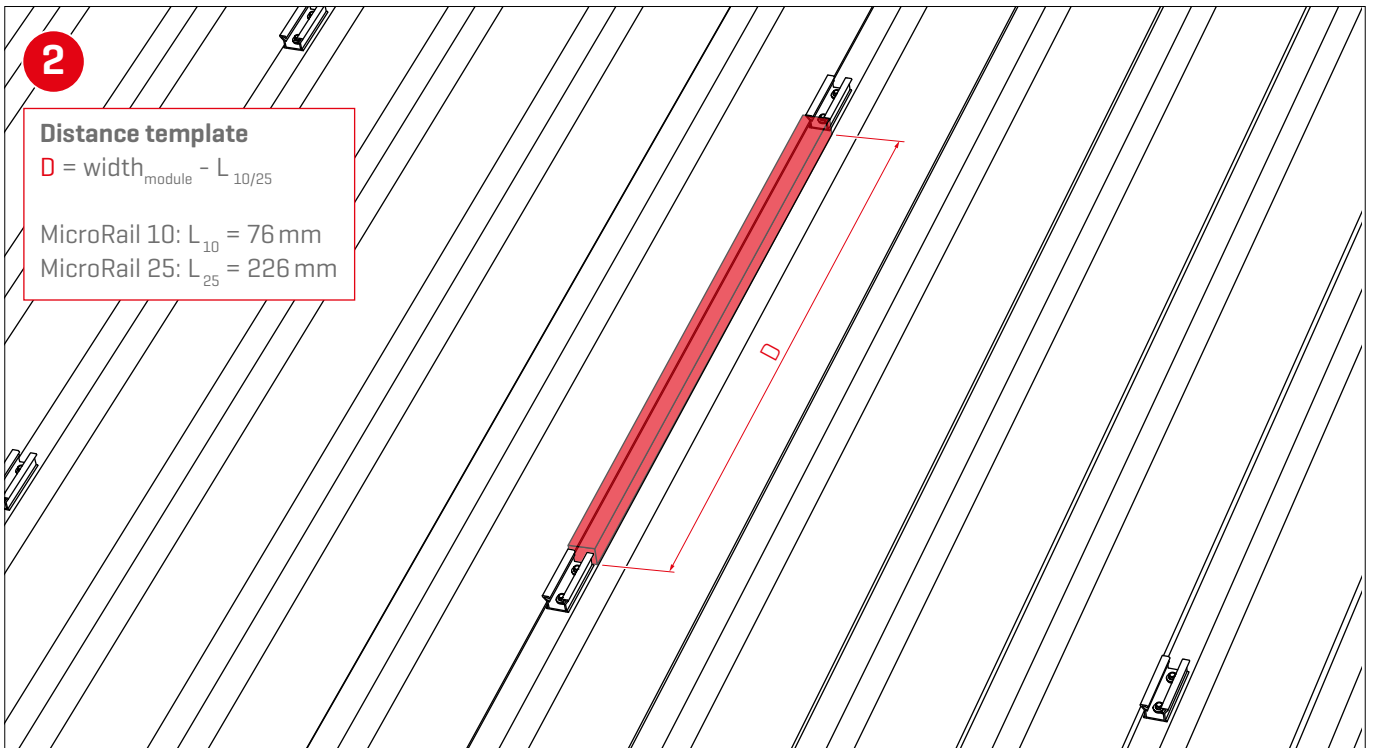

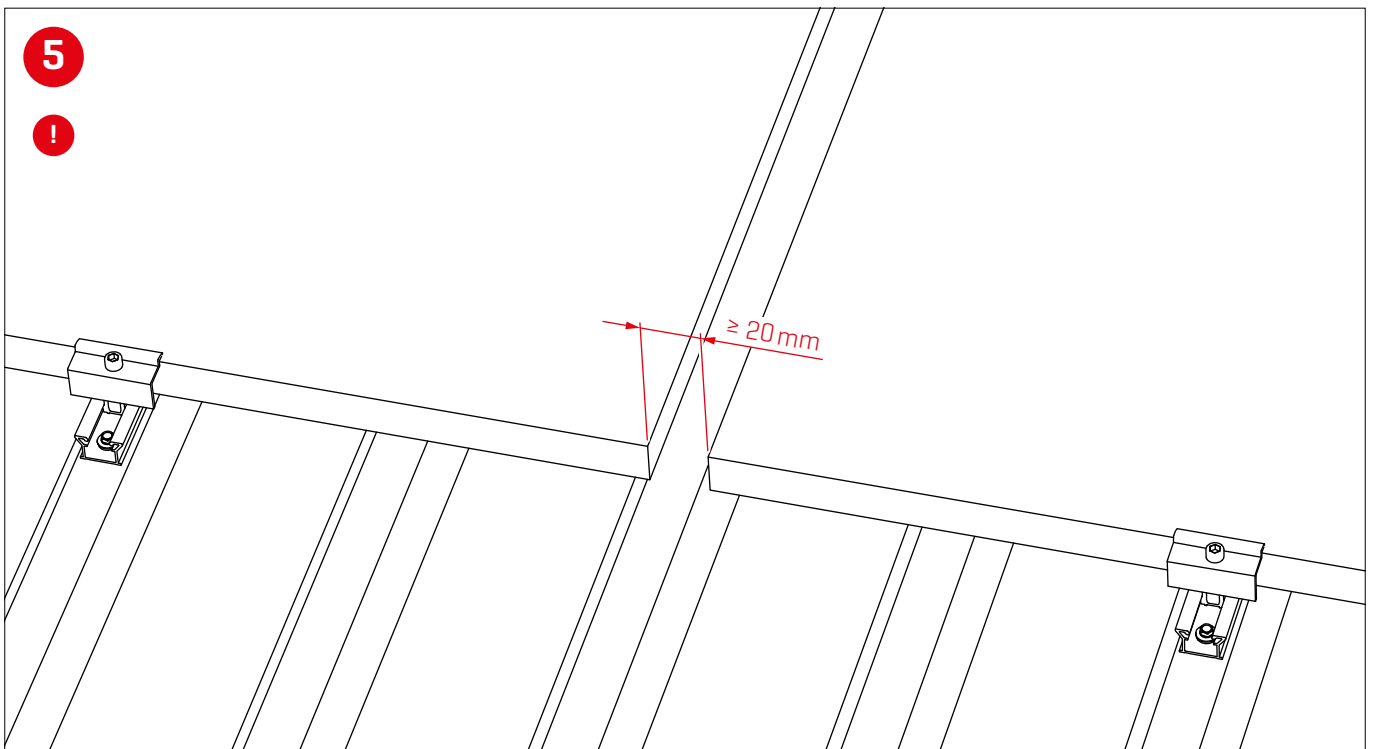
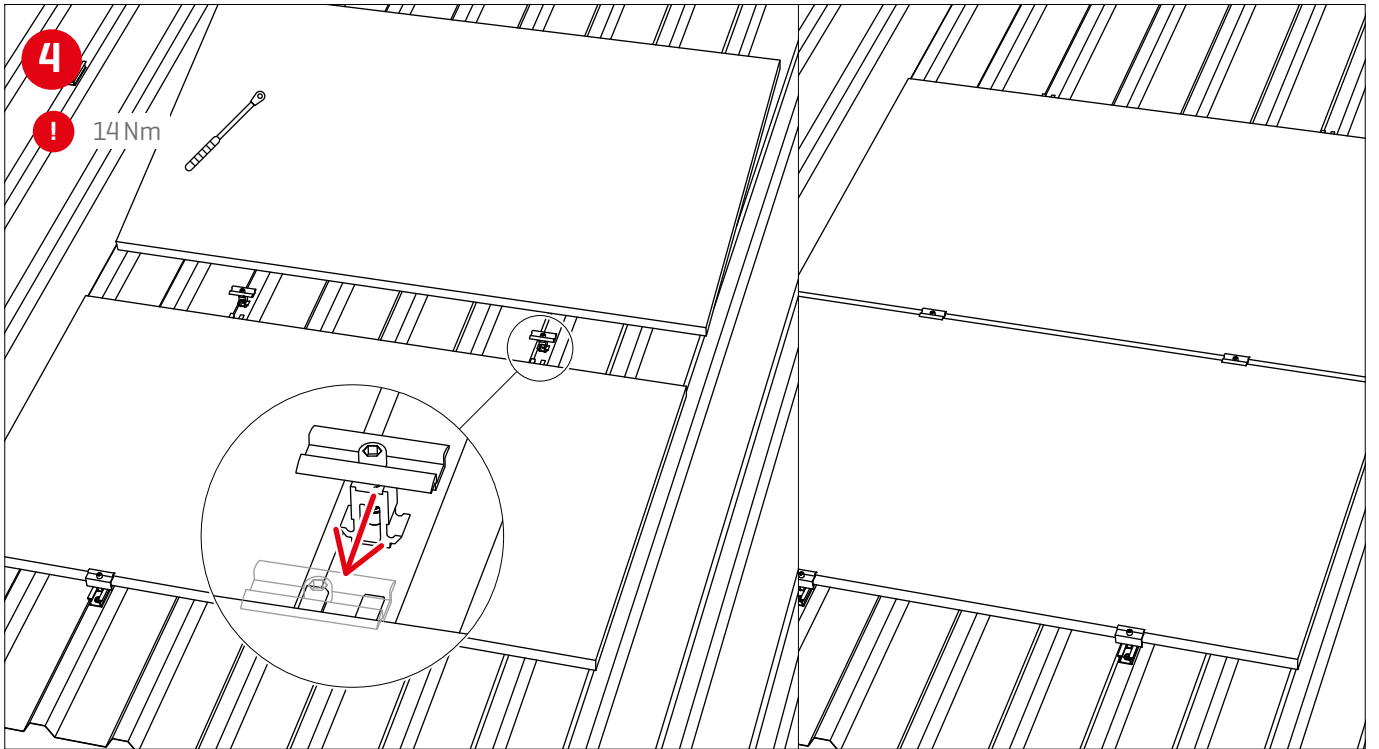

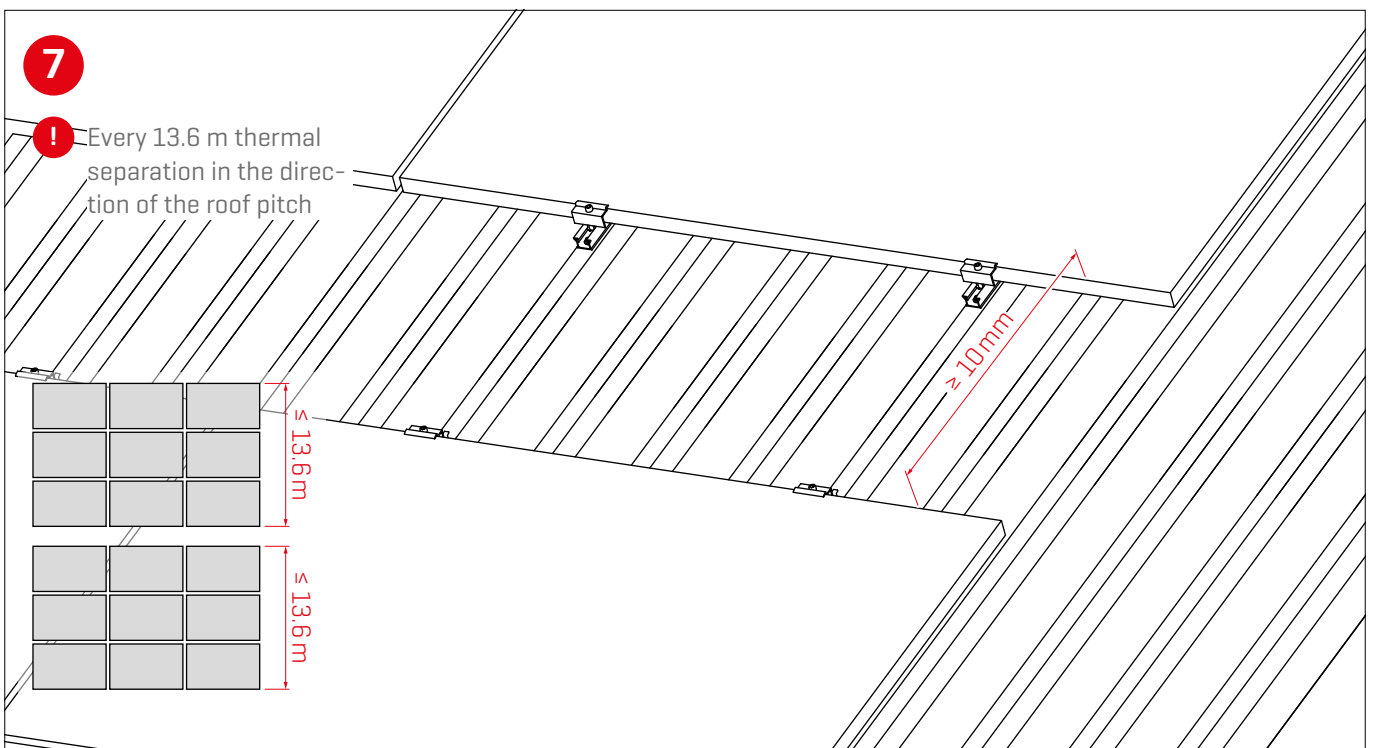
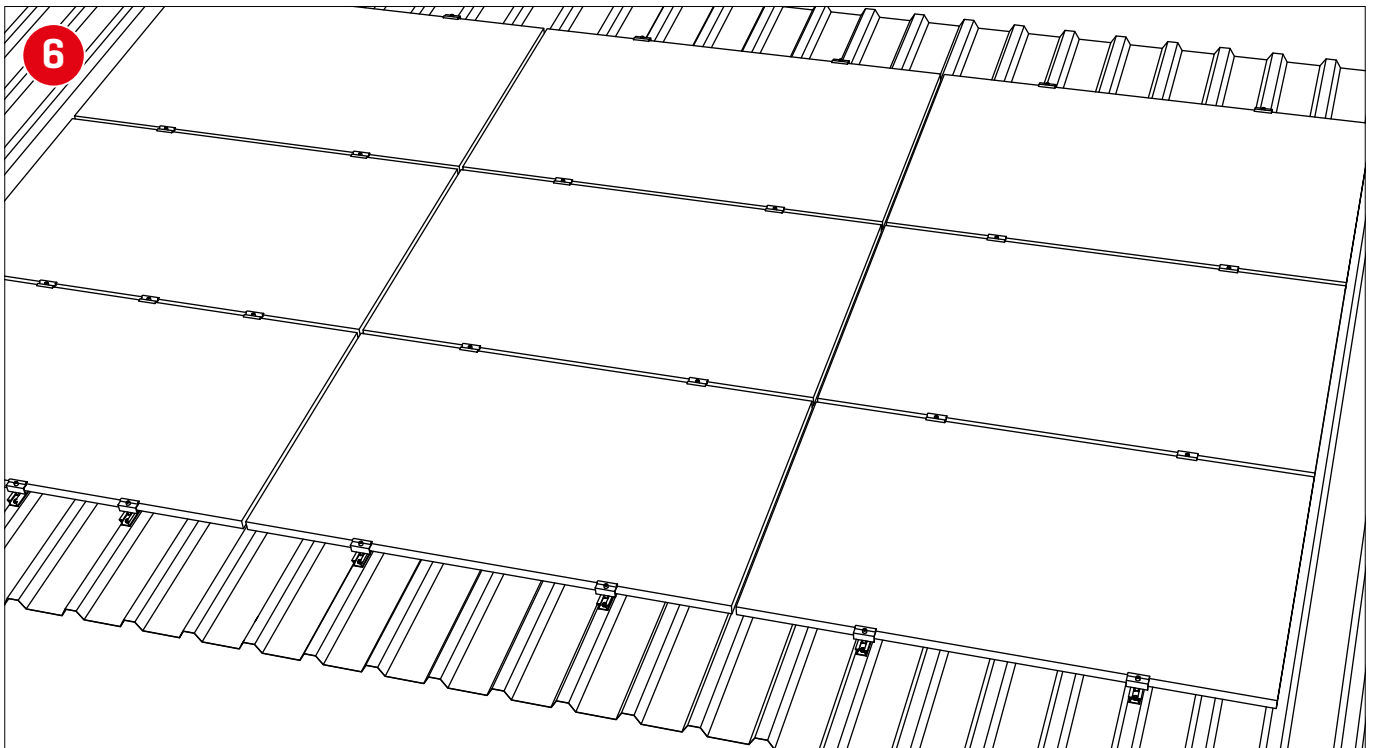

Module frame grounding

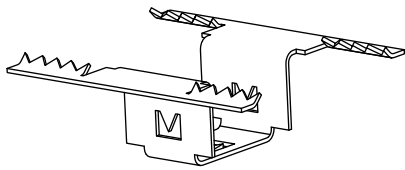
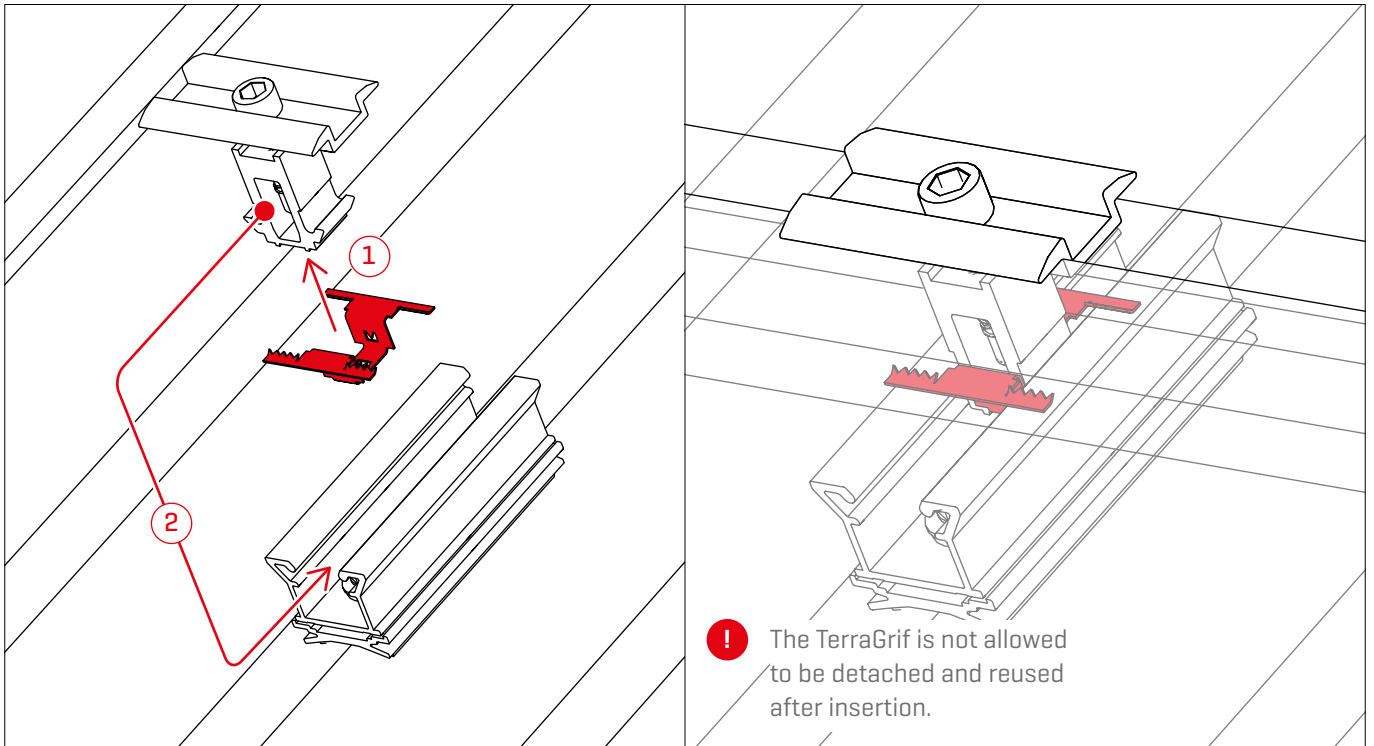

2002649
TerraGrif K2MI

We support PV systems



Thank you for choosing a K2 mounting system.

Systems from K2 Systems are quick and easy to install. We hope these instructions have helped. Please contact us with any questions or suggestions for improvement.

Our contact data:

- ▶ k2-systems.com/en/contact
- ▶ **Service Hotline: +49 (0)7159 42059-0**

German law shall apply excluding the UN Convention on CISG. Place of venue is Stuttgart.

Our General Terms of Business apply. Please refer: k2-systems.com

K2 Systems GmbH
Industriestraße 18
71272 Renningen
Germany
+49 (0) 7159 - 42059 - 0
info@k2-systems.com
www.k2-systems.com