

SmartLogger1000

User Manual

Issue **08**
Date **2015-08-20**

Copyright © Huawei Technologies Co., Ltd. 2015. All rights reserved.

No part of this document may be reproduced or transmitted in any form or by any means without prior written consent of Huawei Technologies Co., Ltd.

Trademarks and Permissions



and other Huawei trademarks are trademarks of Huawei Technologies Co., Ltd.

All other trademarks and trade names mentioned in this document are the property of their respective holders.

Notice

The purchased products, services and features are stipulated by the contract made between Huawei and the customer. All or part of the products, services and features described in this document may not be within the purchase scope or the usage scope. Unless otherwise specified in the contract, all statements, information, and recommendations in this document are provided "AS IS" without warranties, guarantees or representations of any kind, either express or implied.

The information in this document is subject to change without notice. Every effort has been made in the preparation of this document to ensure accuracy of the contents, but all statements, information, and recommendations in this document do not constitute a warranty of any kind, express or implied.

Huawei Technologies Co., Ltd.

Address: Huawei Industrial Base
Bantian, Longgang
Shenzhen 518129
People's Republic of China

Website: <http://www.huawei.com>

Email: support@huawei.com

About This Document

Overview

This document describes the SmartLogger1000 (**SmartLogger**) in terms of installation, electrical connections, system operation and maintenance, and troubleshooting measures. Get familiar with the functions and features of the SmartLogger, and read safety precautions before installing and operating the SmartLogger.





You can print the document. Store the paper copies properly for future use. You can also download the latest documents from <http://support.huawei.com/carrier/>.

Intended Audience

This document is intended for photovoltaic (PV) plant operators and qualified electrical technical personnel.

Symbol Conventions

The symbols that may be found in this document are defined as follows:

| Symbol | Description |
|--|---|
|  DANGER | Indicates an imminently hazardous situation which, if not avoided, will result in death or serious injury. |
|  WARNING | Indicates a potentially hazardous situation which, if not avoided, could result in death or serious injury. |
|  CAUTION | Indicates a potentially hazardous situation which, if not avoided, may result in minor or moderate injury. |
|  NOTICE | Indicates a potentially hazardous situation which, if not avoided, could result in equipment damage, data loss, performance deterioration, or unanticipated results. NOTICE is used to address practices not related to personal injury. |

| Symbol | Description |
|--|---|
|  NOTE | <p>Calls attention to important information, best practices and tips.</p> <p>NOTE is used to address information not related to personal injury, equipment damage, and environment deterioration.</p> |

Change History

Changes between document issues are cumulative. The latest document issue contains all the changes made in earlier issues.

Issue 08 (2015-08-20)

Added [6.2.27 Exporting All Files](#).

Added [6.2.28 Importing All Files](#).

Added [7.29 Setting Modbus TCP Parameters](#).

Issue 07 (2015-01-20)

Added [4.8 Connecting to a PID](#).

Added PLC information query and parameter settings.

Added PID information query and parameter settings.

Added Custom Devices information query and parameter settings.

Added [7.41 Onsite Test](#).

Updated [7.42 Device management](#).

Issue 06 (2014-09-20)

Added [4.5 Connecting to an AC Combiner Box](#).

Added [6.2.8 Querying AC Combiner Box Information](#).

Added [6.2.9 Setting Feature Parameters for an AC Combiner Box](#).

Added [7.5 Querying Running Information of the Power Station](#).

Added [7.13.2 Querying the Performance Data of a Power Meter](#).

Added [7.30 Setting IEC103 Parameters](#).

Issue 05 (2014-05-20)

Added [4.4 Connecting the SmartLogger to a Power Meter](#).

Added [6.2.5 Querying Master SmartLogger Information](#).

Added [6.2.6 Querying Slave SmartLogger Information](#).

Added [6.2.7 Querying Power Meter Information](#).

Added [6.2.19 Setting SmartLogger Contrast](#).

Added [6.2.32 Batch Power-On/Off](#).

Added [7.3 WebUI Layout](#).

Added [7.10.1 Querying the Master SmartLogger Running Information](#).

Added [7.10.2 Querying the Active Alarms of the Master SmartLogger](#).

Added [7.10.3 Querying Running Information of the Slave SmartLogger](#) .

Added [7.27 Setting Power Meter Parameters](#).

Added [8.2 Application Scenarios](#).

Added [9.3 Alarms](#).

Issue 04 (2013-12-01)

This is the fourth official release.

Added **Server+Client** mode as a NetEco parameter in [6.2.22 Setting Communications Parameters](#).

Added address assignments in [6.2.29 Managing Devices](#).

Added the setting of USB parameters in [7.34.2 Setting USB Parameters](#).

Updated parts of the web user interface (WebUI).

Issue 03 (2013-09-10)

This issue is the third official release.

Compared with the second official release, this document updates some operations and figures for the LCD and WebUI.

Issue 02 (2013-06-06)

This issue is the second official release.

Issue 01 (2013-04-25)

This issue is the first official release.

Compared with the original draft, this document updates some operations and figures for the LCD and WebUI.

Contents

| | |
|---|-----------|
| About This Document..... | ii |
| 1 Safety Precautions..... | 1 |
| 1.1 Overview | 1 |
| 1.2 Symbols | 2 |
| 2 Overview..... | 3 |
| 2.1 Product Introduction | 3 |
| 2.2 Appearance | 5 |
| 2.3 Monitoring Panel | 8 |
| 3 Installation..... | 12 |
| 3.1 Installation Process | 12 |
| 3.2 Checking Before Installation | 14 |
| 3.3 Preparing Tools | 15 |
| 3.4 Determining the Installation Position | 16 |
| 3.5 Installing the SmartLogger | 17 |
| 3.5.1 Installing the SmartLogger on a Desk | 17 |
| 3.5.2 Mounting the SmartLogger on a Wall..... | 18 |
| 3.5.3 Mounting the SmartLogger Along a Guide Rail | 20 |
| 4 Electrical Connections..... | 22 |
| 4.1 Port Description | 22 |
| 4.2 Connecting the SmartLogger to Inverters | 22 |
| 4.2.1 Connecting the SmartLogger to the SUN2000 | 22 |
| 4.2.2 Connecting the SmartLogger to the SUN8000 | 26 |
| 4.2.3 Connecting Multiple Inverters to the SmartLogger | 28 |
| 4.3 Connecting to an EMI..... | 29 |
| 4.4 Connecting the SmartLogger to a Power Meter..... | 31 |
| 4.5 Connecting to an AC Combiner Box | 32 |
| 4.6 Connecting to a PLC..... | 34 |
| 4.7 Connecting the SmartLogger to a PC | 36 |
| 4.8 Connecting to a PID..... | 37 |
| 4.9 Connecting the SmartLogger to a Ripple Control Receiver | 38 |
| 5 System Operation..... | 41 |

| | |
|---|------------|
| 5.1 Power-on Process..... | 41 |
| 5.2 Setting Initialization Parameters..... | 42 |
| 6 User Interface..... | 45 |
| 6.1 Monitoring Menu Hierarchy..... | 45 |
| 6.2 Monitoring Operations..... | 47 |
| 6.2.1 Querying Power Station Information..... | 47 |
| 6.2.2 Querying Inverter Information..... | 51 |
| 6.2.3 Manually Powering On or Off the Inverter on the monitoring panel..... | 53 |
| 6.2.4 Querying Information about the EMI..... | 56 |
| 6.2.5 Querying Master SmartLogger Information..... | 58 |
| 6.2.6 Querying Slave SmartLogger Information..... | 60 |
| 6.2.7 Querying Power Meter Information..... | 61 |
| 6.2.8 Querying AC Combiner Box Information..... | 63 |
| 6.2.9 Setting Feature Parameters for an AC Combiner Box..... | 65 |
| 6.2.10 Querying PLC Information..... | 67 |
| 6.2.11 Sending a Reset Command to the PLC..... | 69 |
| 6.2.12 Querying PID Information..... | 71 |
| 6.2.13 Setting Feature Parameters for a PID..... | 73 |
| 6.2.14 Manually Powering On or Off the PID on the monitoring panel..... | 75 |
| 6.2.15 Querying Custom Device Information..... | 78 |
| 6.2.16 Querying Alarm Records..... | 79 |
| 6.2.17 Setting the System Language..... | 83 |
| 6.2.18 Setting System Time Parameters..... | 84 |
| 6.2.19 Setting SmartLogger Contrast..... | 86 |
| 6.2.20 Setting the Currency and Currency Factor..... | 88 |
| 6.2.21 Changing a Password..... | 90 |
| 6.2.22 Setting Communications Parameters..... | 93 |
| 6.2.23 Restoring Factory Settings..... | 97 |
| 6.2.24 Downloading Data by Using a USB Flash Drive..... | 99 |
| 6.2.25 Upgrading Firmware by Using a USB Flash Drive..... | 100 |
| 6.2.26 Batch Upgrade..... | 103 |
| 6.2.27 Exporting All Files..... | 105 |
| 6.2.28 Importing All Files..... | 107 |
| 6.2.29 Managing Devices..... | 108 |
| 6.2.30 Clearing Data..... | 114 |
| 6.2.31 Alarm Reset..... | 116 |
| 6.2.32 Batch Power-On/Off..... | 118 |
| 6.2.33 Querying Product Information..... | 121 |
| 7 Web User Interface..... | 123 |
| 7.1 Preparations for Login..... | 123 |
| 7.2 Logging In to the WebUI..... | 131 |

| | |
|---|-----|
| 7.3 WebUI Layout..... | 132 |
| 7.4 WebUI Menu..... | 133 |
| 7.5 Querying Running Information of the Power Station | 136 |
| 7.6 Querying Current Active Alarms in the System..... | 137 |
| 7.7 Querying System Energy Yield..... | 138 |
| 7.8 Querying System Performance Data..... | 142 |
| 7.9 Querying Device Running Information | 144 |
| 7.10 SmartLogger | 145 |
| 7.10.1 Querying the Master SmartLogger Running Information..... | 145 |
| 7.10.2 Querying the Active Alarms of the Master SmartLogger | 146 |
| 7.10.3 Querying Running Information of the Slave SmartLogger..... | 147 |
| 7.11 Inverters | 148 |
| 7.11.1 Querying Running Information of Inverters | 148 |
| 7.11.2 Manually Powering On or Off the Inverter | 149 |
| 7.11.3 Querying the Active Alarms of an Inverter | 150 |
| 7.11.4 Querying the Performance Data of an Inverter | 150 |
| 7.11.5 Querying the Energy Yield of Inverters | 153 |
| 7.11.6 Setting the Running Parameters of an Inverter | 156 |
| 7.11.7 Setting the Power Grid Standard Code for an Inverter | 159 |
| 7.12 EMI..... | 161 |
| 7.12.1 Querying the Running Information of an EMI | 161 |
| 7.12.2 Querying the Performance Data of an EMI | 162 |
| 7.13 Power Meter..... | 165 |
| 7.13.1 Viewing the Power Meter Running Information..... | 165 |
| 7.13.2 Querying the Performance Data of a Power Meter | 165 |
| 7.14 AC Combiner Box | 168 |
| 7.14.1 Querying Running Information of an AC Combiner Box..... | 168 |
| 7.14.2 Querying the Active Alarms of an AC Combiner Box..... | 168 |
| 7.14.3 Querying the Performance Data of an AC Combiner Box..... | 169 |
| 7.14.4 Setting Running Parameters for an AC Combiner Box | 171 |
| 7.15 PLC..... | 173 |
| 7.15.1 Querying the Running Information of a PLC | 173 |
| 7.15.2 Setting Running Parameters for a PLC | 173 |
| 7.15.3 Setting the PLC STA List..... | 174 |
| 7.15.4 Managing PLC ESNs..... | 175 |
| 7.16 PID..... | 175 |
| 7.16.1 Querying the Running Information of a PID | 175 |
| 7.16.2 Querying the Active Alarms of a PID | 176 |
| 7.16.3 Querying the Performance Data of a PID | 177 |
| 7.16.4 Setting Running Parameters for a PID..... | 179 |
| 7.17 Custom Devices | 180 |
| 7.17.1 Querying Running Information of Custom Devices | 180 |

| | |
|---|------------|
| 7.17.2 Querying Teleindication Information..... | 181 |
| 7.17.3 Querying Telemetry Information | 182 |
| 7.17.4 Setting Telecontrol Parameters | 182 |
| 7.17.5 Setting Teleadjust Parameters | 183 |
| 7.18 Querying Historical Alarms | 184 |
| 7.19 Querying Operation Logs | 185 |
| 7.20 Exporting Data..... | 186 |
| 7.21 Setting Date&Time | 189 |
| 7.22 Setting Plant Information..... | 190 |
| 7.23 Setting Currency Parameters..... | 191 |
| 7.24 Setting Ethernet Parameters..... | 192 |
| 7.25 Setting RS485 Parameters | 193 |
| 7.26 Setting EMI Parameters | 194 |
| 7.27 Setting Power Meter Parameters..... | 196 |
| 7.28 Setting NetEco Parameters | 198 |
| 7.29 Setting Modbus TCP Parameters | 199 |
| 7.30 Setting IEC103 Parameters | 200 |
| 7.31 Setting IEC104 Parameters | 201 |
| 7.32 Setting FTP Parameters..... | 202 |
| 7.33 Setting Email Parameters..... | 203 |
| 7.34 Port Settings..... | 204 |
| 7.34.1 Setting DO Parameters..... | 205 |
| 7.34.2 Setting USB Parameters..... | 208 |
| 7.35 Dry Contact Remote Shutdown | 209 |
| 7.36 Updating the firmware | 211 |
| 7.37 Viewing Product Information | 212 |
| 7.38 Security Settings | 212 |
| 7.39 System Reset..... | 213 |
| 7.40 Exporting Device Logs | 214 |
| 7.41 Onsite Test | 215 |
| 7.42 Device management..... | 217 |
| 7.42.1 Connecting a Device | 217 |
| 7.42.2 Device Name | 219 |
| 7.42.3 Exporting Parameters..... | 220 |
| 7.42.4 Resetting Alarms..... | 221 |
| 8 Grid Dispatch..... | 223 |
| 8.1 Power Grid Dispatching Modes..... | 223 |
| 8.1.1 Active Power Control..... | 223 |
| 8.1.2 Reactive Power Control | 224 |
| 8.2 Application Scenarios | 225 |
| 8.2.1 Local Dispatching | 225 |

| | |
|--|------------|
| 8.2.2 Dry Contact Dispatching | 231 |
| 8.2.3 AI/DI Scheduling | 234 |
| 8.2.4 Communication Scheduling | 239 |
| 9 Maintenance | 242 |
| 9.1 Daily Maintenance | 242 |
| 9.2 Troubleshooting | 242 |
| 9.3 Alarms | 244 |
| 10 Disposing of the SmartLogger | 250 |
| 11 Technical Specifications | 251 |
| 12 Quality Assurance | 253 |
| A Monitoring User List | 254 |

1 Safety Precautions

Read the safety precautions carefully. Otherwise, human injury and equipment damage may occur.

1.1 Overview

This topic describes the precautions for installing and operating the SmartLogger.

Personnel Requirements

- Only qualified and trained electrical technicians are allowed to install and operate the SmartLogger.
- Operation personnel should understand the composition and working principles of the PV grid-tied power generating system and local regulations.

Identification Protection

- The signs on the SmartLogger shell specify important information about secure operations. Do not damage the signs.
- The nameplate attached to the bottom of the SmartLogger lists the SmartLogger parameters. Do not damage the nameplate.

Installation



NOTICE

Before installation, read this document carefully. Huawei shall not be liable for any consequence caused by violation of the regulations specified in this document.

-
- Before installing the SmartLogger, ensure that it is not connected or energized.
 - Install the SmartLogger in well-ventilated environments to ensure system performance.
 - Ensure that the heat dissipation holes of the SmartLogger are not blocked.
 - Do not move the components inside the shelf except for the wiring terminals at the bottom.

Operation



NOTICE

Strictly comply with the safety precautions in this document and associated documents to operate the SmartLogger.

When operating the SmartLogger, follow local laws and regulations.

Maintenance and Replacement

- A faulty SmartLogger requires overall maintenance. Contact the dealer if any fault occurs in the SmartLogger shelf.
- Maintain the SmartLogger after you get familiar with this document and tools and testing equipment are available.
- When maintaining the SmartLogger, wear ESD gloves and comply with ESD precautions.

1.2 Symbols

The following table describes all symbols on the SmartLogger.

| Symbol | Name | Meaning |
|--------|---|--|
| | CE certification label | This product complies with the Conformance Européenne (CE) certification standards. |
| | VCCI certification label | This product complies with Voluntary Control Council for Interference by Information Technology Equipment (VCCI) certification standards. |
| | Environmentally friendly use period (EFUP) label | This product does not pollute the environment during a specified period. |
| | EU waste electrical and electronic equipment (WEEE) label | Do not dispose of the SmartLogger as household garbage. For details about how to deal with the undesirable SmartLogger, refer to 10 Disposing of the SmartLogger . |

2 Overview

This topic describes the SmartLogger in terms of functions, networking applications, product features, appearance, and the monitoring panel.

2.1 Product Introduction

This section describes the SmartLogger in terms of functions, networking applications, and product features.

Functions

The SmartLogger is dedicated for monitoring and managing the PV power generating system. It converges all ports, converts protocols, collects and stores data, and centrally monitors and maintains the PV power generating system.

Networking

The SmartLogger applies to a PV system.

- It can monitor Huawei inverters, AC combiner boxes, PID, and other devices.
- It supports third-party devices such as inverters, environment monitoring instruments, AC combiner boxes, box-type transformers, and smart meters that use the standard Modbus protocol or provide RS485 ports.
- It can simultaneously connect to the Huawei and third-party network management systems by using the Modbus-TCP and IEC104 protocols.

The SmartLogger networking is shown in [Figure 2-1](#).

Figure 2-1 SmartLogger networking

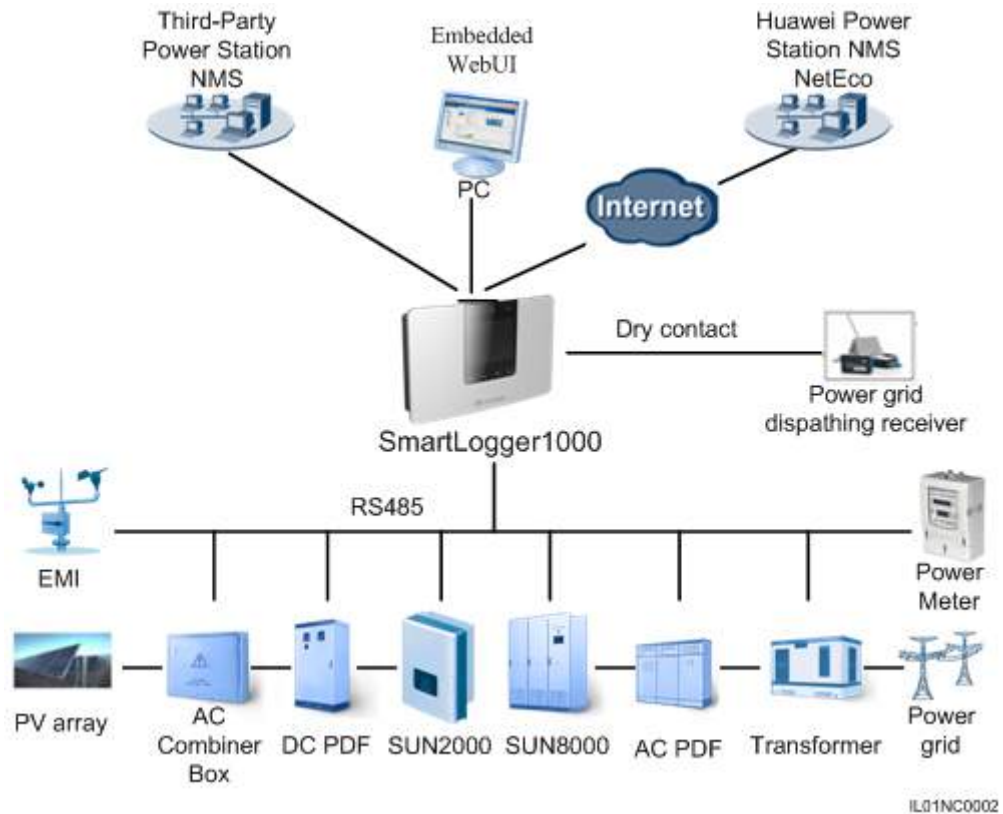

Features

The SmartLogger has the following features:

- Central monitoring
 - Centrally monitors a maximum of 80 devices.
 - Allows users to view information about the power station, devices, products, and alarms, set parameters, and maintain devices on the liquid crystal display (LCD).
 - Allows users to monitor and manage the PV power generating system on the embedded WebUI, for example, viewing real-time information about the power station, devices, and faults, and setting device parameters in remote mode.
- Graphical data
 - Displays energy yields and real-time monitoring information on the LCD in graphics and texts.
 - Displays energy yields, real-time monitoring information, and performance data of the power station and devices on the embedded WebUI in tables and curves.
- Convenient maintenance
 - Allows users to upgrade the firmware of the SmartLogger and inverters and export data by using a USB flash drive.
 - Allows users to upgrade the firmware of the SmartLogger or inverters and export logs over the embedded WebUI.
- Grid dispatching

Supports power grid dispatching: active power reduction and reactive power compensation.

- Intelligent management
 - Automatically scans and identifies Huawei inverters and AC combiner boxes and supports protocol conversion for third-party devices
 - Supports access from third-party devices that use the standard Modbus-RTU protocol.
 - Automatically assigns RS485 addresses to the connected inverters and allows for adjusting RS485 addresses based on device sequence numbers to facilitate remote configuration and maintenance.
 - Supports remote setting of inverter parameters and synchronizes the parameters of one inverter to other inverters in batches.
- Remote maintenance
 - Supports connection to Huawei NetEco and a third-party network management system (NMS) simultaneously using Modbus-TCP and IEC104 to remotely manage all devices.
 - Allows users to access a third-party NMS over the File Transfer Protocol (FTP).
 - Sends energy yield and fault information to users by emails.

2.2 Appearance

This topic describes the SmartLogger in terms of its appearance and specifications.

Front View of the Shell

Figure 2-2 Front view of the SmartLogger

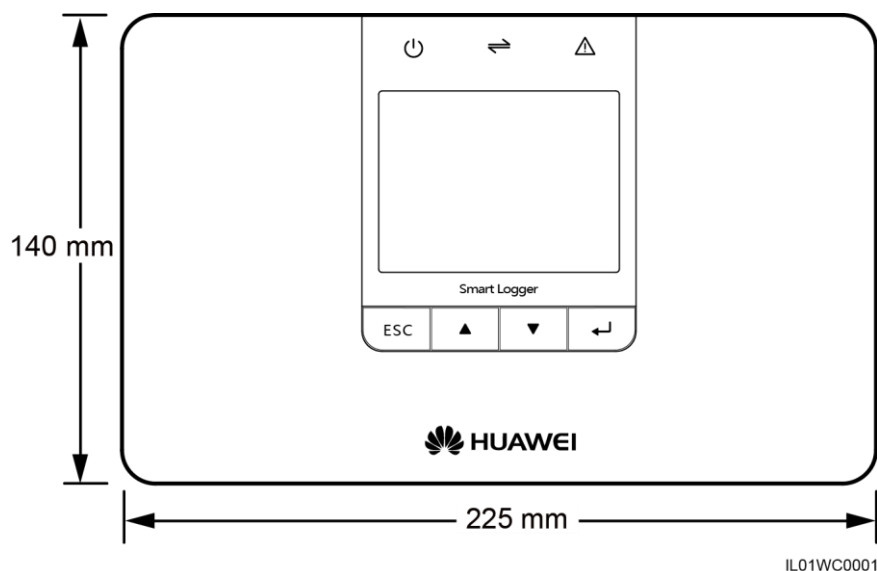



NOTE

The LCD on the SmartLogger monitoring panel displays information about the power site, devices, alarms, and products. This topic describes how to set parameters and maintain devices over the monitoring panel.

Side View of the shell

Figure 2-3 Side view of the SmartLogger

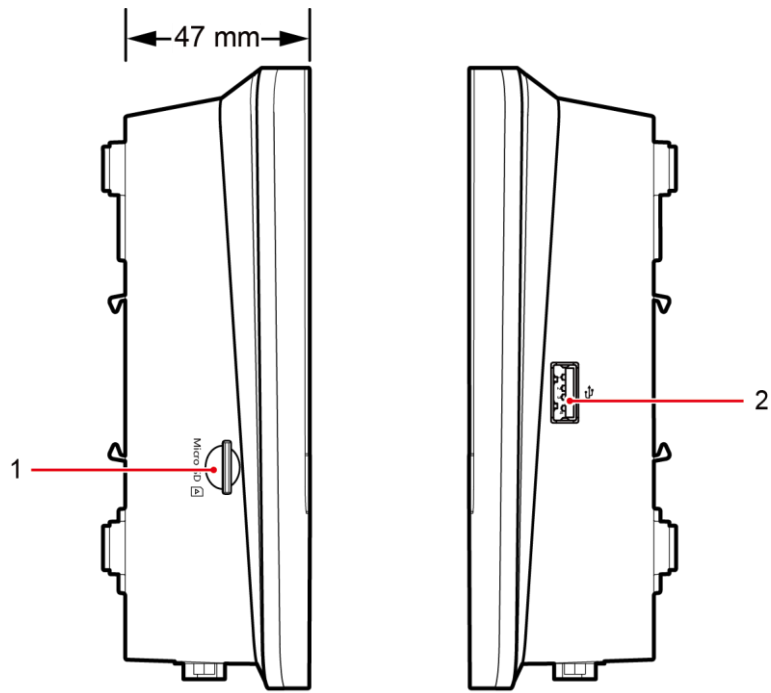

IL01WC0002

1. SD card slot

2. USB port

Rear View of the Shell

Figure 2-4 Rear view of the SmartLogger

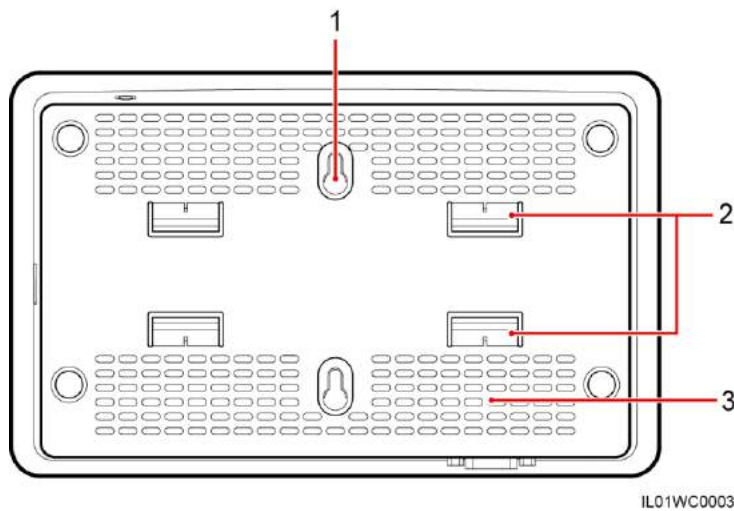

1. Mounting hole

2. Rail snap

3. Heat dissipation hole

Bottom of the Shell

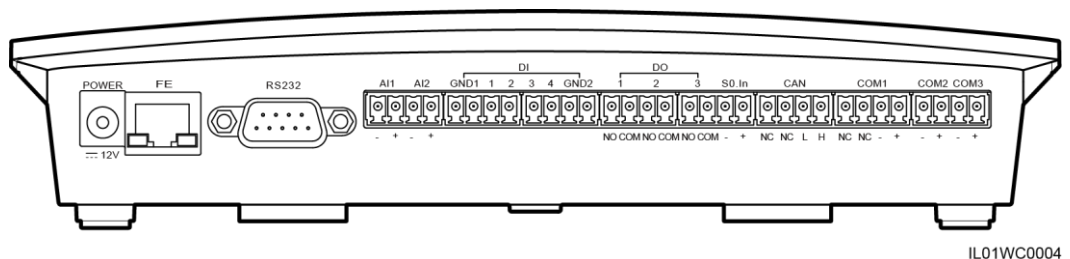

Figure 2-5 Bottom view of the SmartLogger



The following table describes functions of each port of the SmartLogger, as shown in [Table 2-1](#).

Table 2-1 Port description

| Port | Function | Description |
|-------|--------------|--|
| POWER | Power supply | 12 V DC. |
| FE | Ethernet | Connects to PC or routers. |
| RS232 | RS232 | Connects to external RS232 devices (reserved). |
| AI | Analog input | 12 V current-type signal (reserved). |

| Port | Function | Description |
|--|---------------------------------------|---|
| DI | Digital parameter input | Connects to the power grid scheduling signal controlled by dry contacts. |
| DO | Digital parameter output | Relay output. |
| S0.In | Connects to pulse output power meters | Reserved. |
| CAN | CAN | Reserved. |
| COM1-COM3 | RS485 | Provides three RS485 ports that can be connected to devices such as the inverter and the environment monitoring instrument. |
| Micro SD  | SD card slot | Reserved. |
|  | USB port | Connects a USB flash drive. |

2.3 Monitoring Panel

This topic describes the monitoring panel, including an LCD, indicators, buttons, and the default page.

Monitoring panel

The monitoring panel provides one LCD, three indicators, and four buttons, as shown in [Figure 2-6](#).

Figure 2-6 Monitoring panel

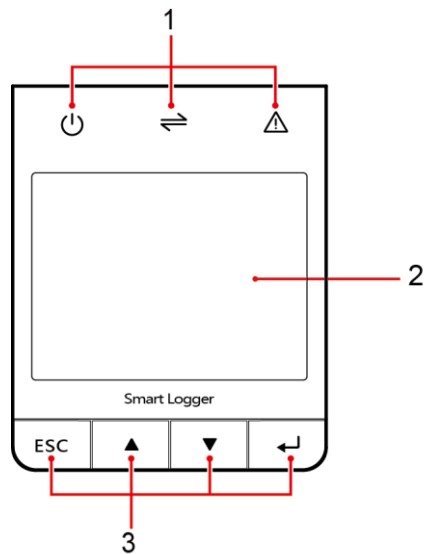

IL01WC0005

1. Indicator

2. LCD



3. Button

Indicators

There are three indicators on the monitoring panel. They are Power indicator, Run indicator, and Alarm indicator from left to right.

[Table 2-2](#) describes the indicators.

Table 2-2 Indicator description

| Indicator | Status | Meaning |
|--|--|---|
| Power indicator  | Steady green | The power supply is normal. |
| | Off | There is no power supply. |
| Run indicator  | Blinking green (on for 1s and then off for 1s) | The SmartLogger is working. |
| | Off | The SmartLogger stops working. |
| Alarm indicator  | Steady red | The inverter connected to the SmartLogger generates a major alarm. For details about the alarm, see 6.2.16 Querying Alarm Records . |
| | Blinking red (on for 0.5s and then off for 0.5s) | The inverter connected to the SmartLogger generates a minor alarm. For details about the alarm, see 6.2.16 Querying Alarm Records . |

| Indicator | Status | Meaning |
|-----------|--|---|
| | Blinking red (on for 1s and then off for 4s) | The inverter connected to the SmartLogger generates a warning. For details about the warning, see 6.2.16 Querying Alarm Records . |
| | Off | The inverter connected to the SmartLogger is working normally. |

LCD

The LCD displays data in graphics and text, including the information about the site, devices, alarms and products. Users can also set parameters and maintain devices on the LCD.

If you do not press any button within 90s on a non-default page, the LCD returns to the default page automatically, as shown in [Figure 2-7](#).

Figure 2-7 Default page

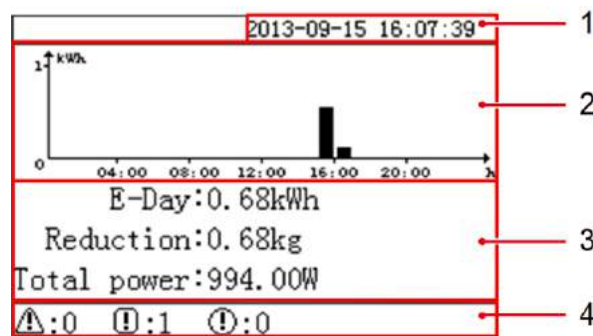

| | |
|--------------------------------|--|
| 1. Date and time | Allows you to view the date and time. |
| 2. Energy production histogram | Allows you to view the total energy production in each hour by all the inverters connected to the SmartLogger. |
| 3. Energy production data | <ul style="list-style-type: none"> Allows you to view the total energy production from 0:00 to the current time by all the inverters connected to the SmartLogger. Allows you to view the emission reduction of CO₂ corresponding to the energy yield of the current day. Allows you to view the total output power by all the online inverters connected to the SmartLogger at the present. |
| 4. Status information | Allows you to view the number of the major alarms, minor alarms, and warnings of all the inverters connected to the SmartLogger. When remote grid dispatching is enabled, you can view the current status of grid dispatching. |

Buttons

There are four buttons on monitoring panel. They are the Return button, Cursor Up button, Cursor Down button, and Confirm button from left to right.

Table 2-3 describes the button functions.

Table 2-3 Button description

| Buttons | Name | Functions |
|---------|--------------------|---|
| ESC | Return button | Allows you to return to the last page or end an operation. |
| ▲ | Cursor Down button | Allows you to go to the upper-level menu or set parameters. |
| ▼ | Cursor Up button | Allows you to go to the lower-level menu or set parameters. |
| ↵ | Confirm button | Allows you to go to the menu or confirm the value. |

**NOTE**

The backlight lasts 120s after you press any button.

3 Installation

This topic describes how to install the SmartLogger.

Context

Install the SmartLogger in an appropriate position and surface.



DANGER

- Do not store the SmartLogger in areas with flammable or explosive materials.
 - Do not install the SmartLogger on flammable building materials.
-

3.1 Installation Process

This topic describes the SmartLogger installation process.

The SmartLogger installation process is shown in [Figure 3-1](#).

Figure 3-1 Installation flowchart

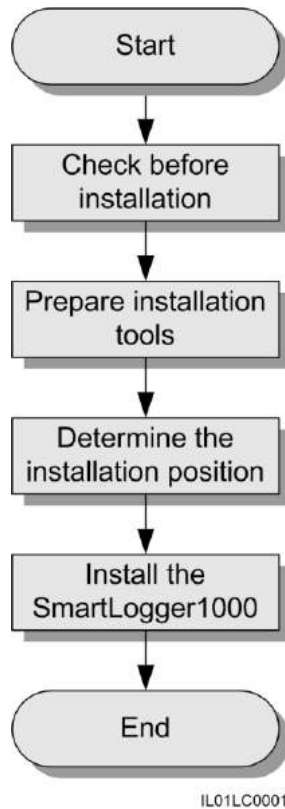

Table 3-1 describes the installation process.

Table 3-1 Description of the installation process

| Step | Operation | Description |
|------|--------------------------------------|--|
| 1 | Checking Before Installation | Before unpacking, check that the outer packing materials are intact. After unpacking, check that deliverables are complete and intact. |
| 2 | Preparing Tools | Prepare tools required for installation and electrical connections. |
| 3 | Determine the installation position. | Before installing the SmartLogger, determine an appropriate position to ensure that the SmartLogger works properly. |
| 4 | Installing the SmartLogger | The SmartLogger can be installed on a desk, a wall or along a guide rail. |

3.2 Checking Before Installation

Before unpacking, check that the outer packing materials are intact. After unpacking, check that deliverables are complete and intact.

Checking Outer Packing Materials

Check the outer packing materials for damage before unpack the SmartLogger, such as holes and cracks. If any damage is found, do not unpack the SmartLogger and contact the dealer as soon as possible.

Checking Deliverables

After unpacking the SmartLogger, check whether deliverables are intact and complete. If any damage is found or any component is missing, contact the dealer.

Figure 3-2 shows the components and mechanical parts that should be delivered.

Figure 3-2 Deliverables

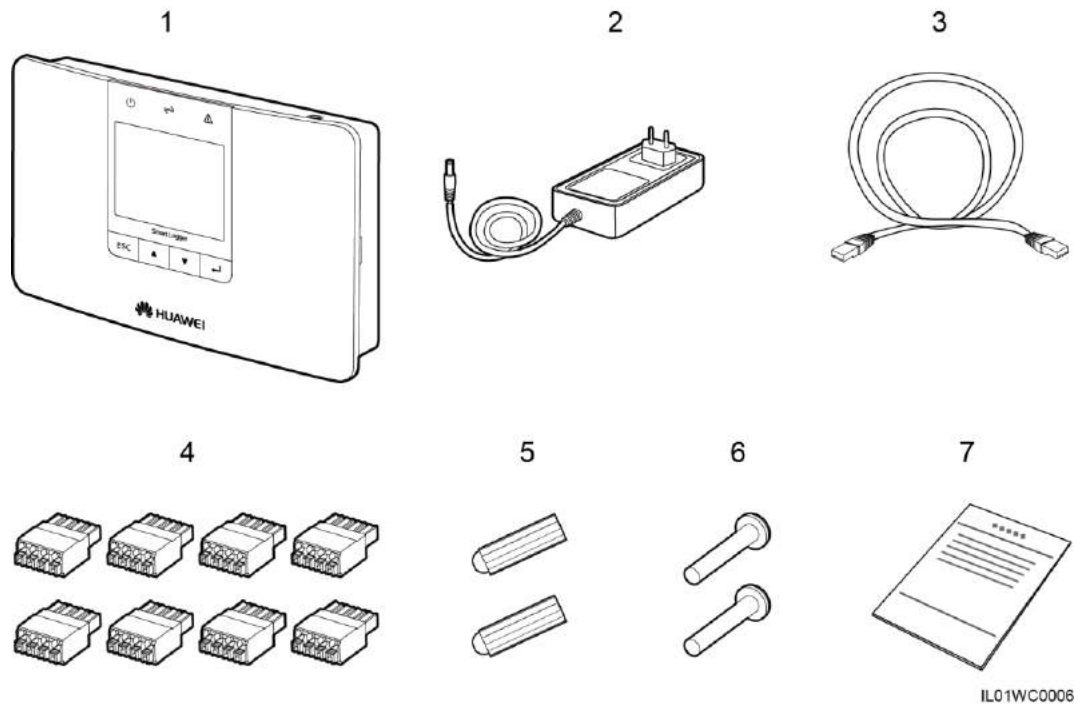







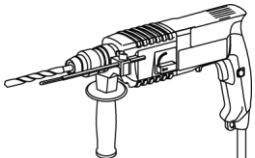
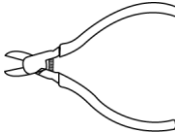
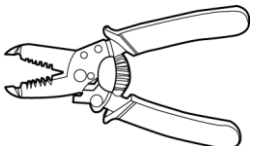

| No. | Quantity | Description |
|-----|----------|--|
| 1 | 1 | SmartLogger |
| 2 | 1 | Adapter (adapter type depends on the country specified in the order) |
| 3 | 1 | Network cable (2.2 meters long) |
| 4 | 8 | Terminal block |

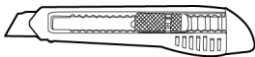
| No. | Quantity | Description |
|-----|----------|---|
| 5 | 2 | Expansion tube |
| 6 | 2 | Screws (used to secure the SmartLogger to the wall) |
| 7 | 1 | Auxiliary documents |

3.3 Preparing Tools

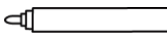
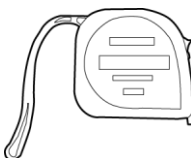
Prepare tools required for installation and electrical connections.

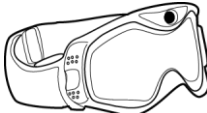
| Tools | Model | Function |
|--|--------------|--|
|  Hammer drill | Φ6 drill bit | Drills holes in the wall when the SmartLogger is wall-mounted. |
|  Diagonal pliers | - | Cuts and tighten cable ties. |
|  Wire stripper | - | Peels cable jackets. |
|  Rubber mallet | - | Hammers expansion bolts into holes. |
|  Guarded blade utility knife | - | Removes package. |
|  Cable cutter | - | Cuts cables. |

| Tools | Model | Function |
|---|------------------------|---|
| Vacuum cleaner  | - | Cleans up dust after holes are drilled. |
| Marker  | Diameter: ≤ 10 mm | Marks signs. |
| Measuring tape  | - | Measures distance |
| Plumb line  | - | Ensures that the screws are perpendicular to the wall. |
| Safety goggles  | - | Protect your eyes during hole drilling. |
| Anti-dust respirator  | - | Prevents dust from entering your mouth and nostrils during hole drilling. |

3.4 Determining the Installation Position

Before installing the SmartLogger, determine an appropriate position to ensure that the SmartLogger works properly.

Comply with the following requirements when determining the installation position for the SmartLogger:

- Do not install the SmartLogger outdoors because it is protected to IP20.

- Install the SmartLogger in a dry environment to protect it against water.
- The ambient temperature should range from -20 °C to +60 °C.
- The communication distance for the RS485 port should be less than 1000 m and for the Ethernet less than 100 m.
- Install the SmartLogger at an appropriate height for the user's ease to view and operate on the monitoring panel.
- Do not place the SmartLogger upside down. Ensure that the heat dissipation holes are facing upwards, preventing dust from entering the SmartLogger and reducing its service life.
- Choose appropriate installation method and position for the Smart Logger according to its weight and size. For details, refer to [11 Technical Specifications](#).
- If you install the SmartLogger on a wall or along a guide rail, the area for connecting cables should be downwards.
- The SmartLogger is at least 100 mm away from the neighboring objects on both sides, the top side, and the bottom side respectively, as shown in [Figure 3-3](#).

Figure 3-3 Minimum installation clearance

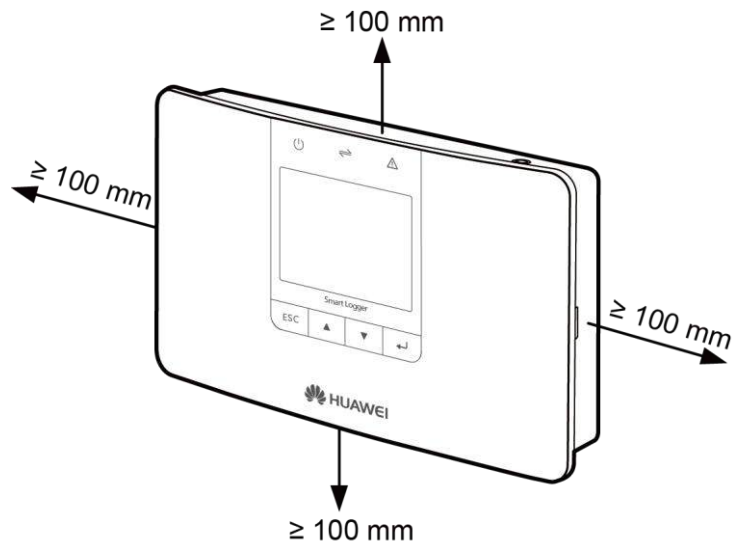

IL01SC0001

3.5 Installing the SmartLogger

The SmartLogger can be installed on a desk, on a wall, or along a guide rail.

3.5.1 Installing the SmartLogger on a Desk

This topic describes how to install the SmartLogger on a desk.

Context



NOTICE

- Ensure that the desk on which the SmartLogger is installed is horizontal to prevent it from falling down.
 - Install the SmartLogger in places where cables cannot be easily touched to avoid signal disruption.
-

Procedure

Step 1 Take the SmartLogger out from the package.

Step 2 Place the SmartLogger onto a horizontal desk.

----End

3.5.2 Mounting the SmartLogger on a Wall

This topic describes how to mount the SmartLogger on a wall.

Context



NOTICE

- Install the SmartLogger on a solid and smooth wall to ensure that it can be secured on the wall.
 - Before hanging the SmartLogger on the screws, secure the expansion tubes and screws into the wall.
-

Procedure

Step 1 Install the expansion tubes and screws.



NOTICE

If you need to use a ladder to install the SmartLogger on a high position, keep balance to protect yourself from falling down.

1. Use a plumb line to ensure that the line between the centric points of the two holes is vertical to the ground. Use a marker to mark out the holes, as shown in [Figure 3-4](#).

Figure 3-4 Hole positions and dimensions

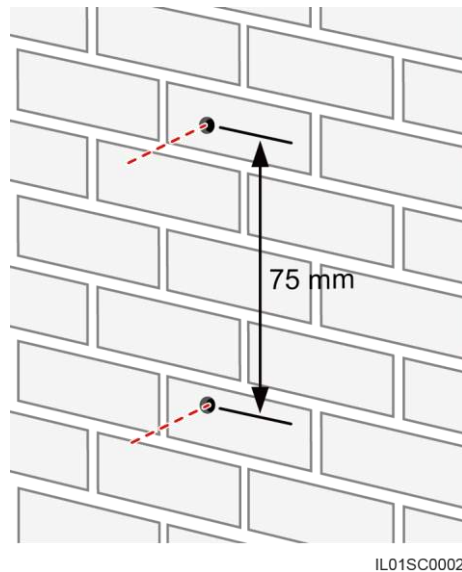

IL01SC0002

2. Drill holes using a hammer drill and install expansion tubes and screws, as shown in [Figure 3-5](#).

Figure 3-5 Drilling a hole and installing an expansion tubes and screws

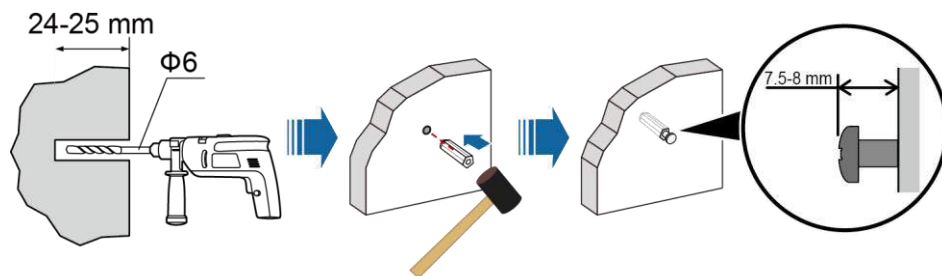

IL01HC0001

[Table 3-2](#) describes the operations shown in [Figure 3-5](#).

Table 3-2 Drilling a hole and installing an expansion tubes and screws

| Step | Operation |
|------|---|
| 1 | <p>Put a hammer drill with a $\Phi 6$ drill bit on a marked hole position perpendicularly against the wall and drill holes with a depth of 24 mm to 25 mm.</p> <p>NOTICE</p> <ul style="list-style-type: none"> • To prevent dust inhalation or contact with eyes, wear safety goggles and an anti-dust respirator when drilling holes. • Wipe away any dust in or around the holes and measure the hole distance. If the holes are inaccurately positioned, drill holes again. |
| 2 | Vertically insert an expansion tube into a hole, and knock it completely into the hole by using a rubber mallet. |

| Step | Operation |
|------|--|
| 3 | Insert the screws into the expansion tube until the screw heads are 7.5 mm to 8 mm away from the wall. |

Step 2 Hang the SmartLogger onto the secured screws by the mounting holes on the rear of the SmartLogger.



NOTICE

Ensure that the area for connecting cables in the SmartLogger is downwards for the ease of electrical connections and maintenance.

----End

3.5.3 Mounting the SmartLogger Along a Guide Rail

This topic describes how to mount the SmartLogger along a guide rail.

Context

The guide rails are not delivered together with the SmartLogger. If you need to mount the SmartLogger along a guide rail, prepare a 35 mm wide guide rail.



NOTICE

- Choose a guide rail with appropriate lengths to ensure that the SmartLogger can be secured along it.
- Secure the guide rail before mounting the SmartLogger.

Procedure

Step 1 Hold both sides of the SmartLogger, keep it parallel with the guide rail, and then tilt it slightly to insert its upper hooks into the guide rail, as shown in [Figure 3-6](#).

Figure 3-6 Mounting the SmartLogger Along a guide rail (1)

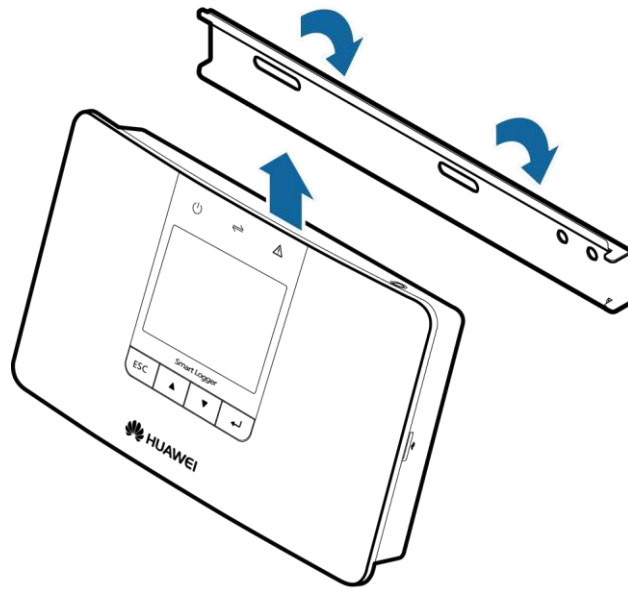

IL01HC0002

Step 2 Hold the two lower corners of the SmartLogger, pull it downwards appropriately, and then push it towards the guide rail. When you hear a click sound, the SmartLogger is successfully mounted along the guide rail, as shown in [Figure 3-7](#).

Figure 3-7 Mounting the SmartLogger along a guide rail (2)

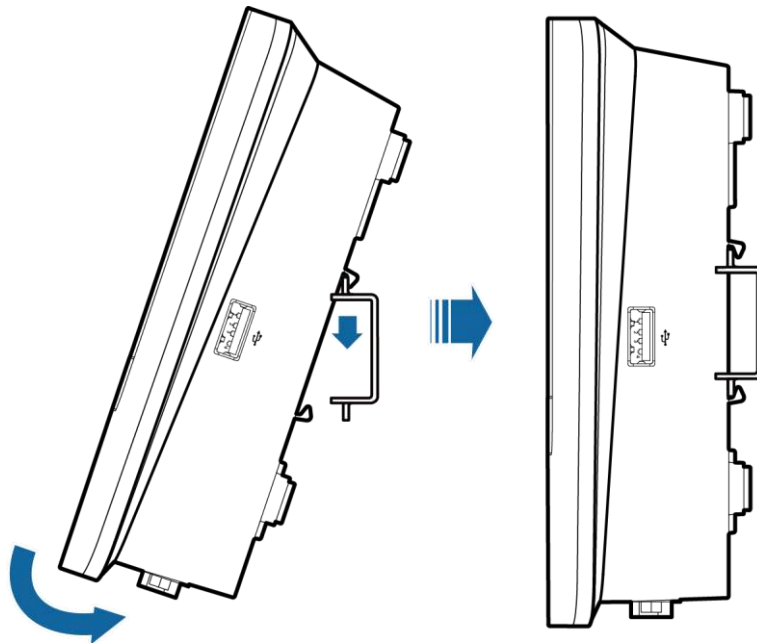

IL01HC0003

----End

4 Electrical Connections

This topic describes how to connect the SmartLogger to the inverters, environmental monitoring instrument, and PCs.

Context



NOTICE

- Ensure that all cables are connected and secured.
 - Do not connect a power adapter to the SmartLogger before the cable connections are complete because the SmartLogger has no startup button.
-

4.1 Port Description

This topic describes the functions of ports in the SmartLogger.

For the bottom view of the SmartLogger and port description, see [Bottom of the Shell](#) in [2.2 Appearance](#).

4.2 Connecting the SmartLogger to Inverters

This topic describes how to connect the SmartLogger to inverters.

4.2.1 Connecting the SmartLogger to the SUN2000

This topic describes how to connect the SmartLogger to the SUN2000.

Context

The RS485 communications port for the SUN2000 is an RJ45 port, which is connected over a crystal plug, as shown in [Figure 4-1](#).

Figure 4-1 RS485 crystal plug of the SUN2000 (side view without the fastener)

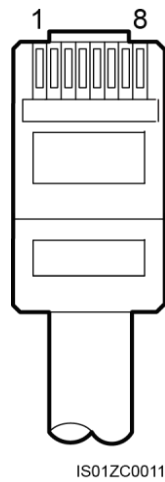

Table 4-1 lists the cable colors and functions.

Table 4-1 Cable colors and functions

| Category | Color | Function |
|----------|------------------|-------------------------------------|
| 1 | White and orange | RS485A, RS485 differential signal + |
| 2 | Orange | RS485B, RS485 differential signal - |
| 3 | White and green | PGND |
| 4 | Blue | RS485A, RS485 differential signal + |
| 5 | White and blue | RS485B, RS485 differential signal - |
| 6 | Green | PGND |
| 7 | White and brown | PGND |
| 8 | Brown | PGND |

There are three COM ports for the RS485 communications of the SmartLogger, as shown in Figure 4-2.

Figure 4-2 COM ports on the SmartLogger

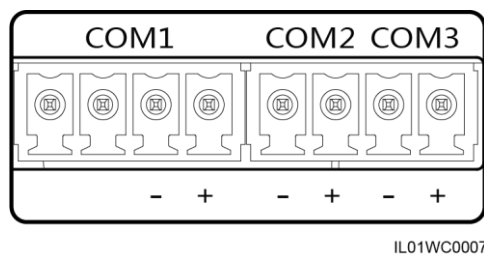

Table 4-2 describes the definition of the COM ports.

Table 4-2 COM port description

| Port | Identifier | Function |
|-----------|------------|-------------------------------------|
| COM1 port | NC | Reserved |
| | NC | Reserved |
| | - | RS485B, RS485 differential signal - |
| | + | RS485A, RS485 differential signal + |
| COM2 port | - | RS485B, RS485 differential signal - |
| | + | RS485A, RS485 differential signal + |
| COM3 port | - | RS485B, RS485 differential signal - |
| | + | RS485A, RS485 differential signal + |

Figure 4-3 shows how to connect the SmartLogger to the SUN2000.

Figure 4-3 Connecting the SmartLogger to the SUN2000

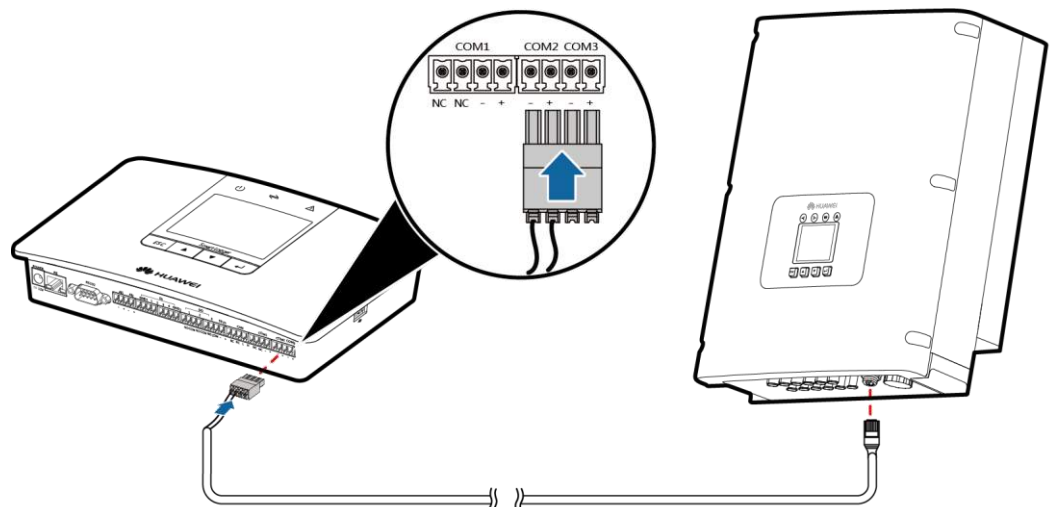

IL011C3001

Procedure

Step 1 Obtain a shielded network cable with an appropriate length. Crimp the crystal plug to one of its ends and then connect the end to the RS485 port in the SUN2000.

- Recommended communications cable model: CAT 5E outdoor shielded network cable.
- For details about how to connect the crystal plug to one end of the cable, see the *SUN2000 (8KTL-28KTL) User Manual*.

Step 2 Use a wire stripper to peel off 15 mm long of the external insulation layer on the other end of the shielded network cable.

Step 3 Use a wire stripper to peel off 10 mm long of the internal insulation layer on the white-orange (or blue) core wire and the orange (or white-blue) core wire. And cut off 15 mm long of the other six core wires.

Step 4 Connect cables to the terminal block.

Ensure that the white-orange (or blue) core wire connects to the wiring terminal that connects to the **COM+** port and that the orange (or white-blue) core wire connects to the wiring terminal that connects to the **COM-** port.

Figure 4-4 Connecting cables to the terminal block

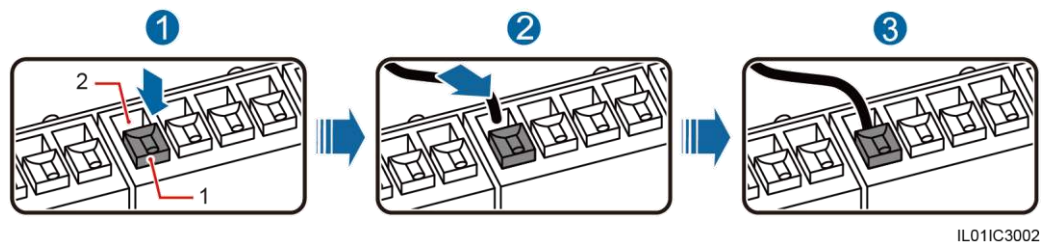

1. White contact plate

2. Wiring terminal

Figure 4-4 describes the operations shown in Table 4-3.

Table 4-3 Connecting cables to the terminal block

| Step | Operation |
|------|--|
| 1 | Press the white contact plate to flip the metal spring inside the wiring terminal. |
| 2 | Insert the uninsulated parts of the core wires into the wiring terminals. |
| 3 | Let go the white contact plate to fasten the core wire. |

Step 5 Connect the terminal block to the COM port on the SmartLogger, as shown in Figure 4-5.

Figure 4-5 Connecting the terminal block to the SmartLogger

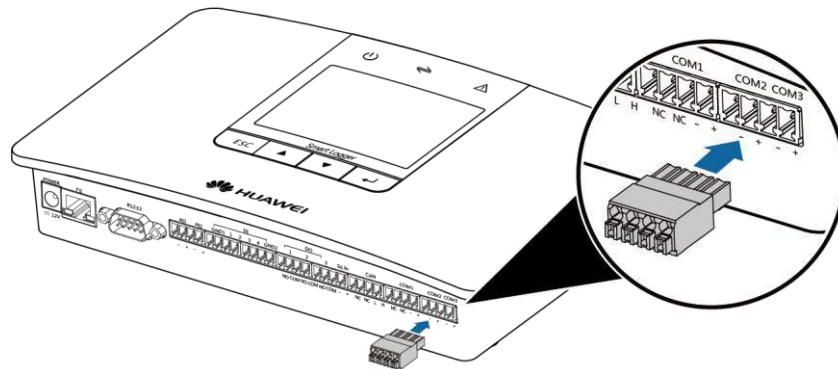

IL011C0001

Step 6 Ensure that the cable is correctly connected and secured. Set **Baud rate** for the SUN2000 and the SmartLogger and ensure that the parameters for these two devices are consistent.

- For details about how to set the communications parameters for the SmartLogger, see [6.2.22 Setting Communications Parameters](#).
- For how to set the communications parameters for the SUN2000, see the *SUN2000 (8KTL-28KTL) User Manual*.

----End

Follow-up Procedure

Take operations in reversed order to disconnect the SmartLogger from the SUN2000.

4.2.2 Connecting the SmartLogger to the SUN8000

This topic describes how to connect the SmartLogger to the SUN8000.

Context

[Figure 4-6](#) shows the RS485 wiring terminals of the SUN8000.

Figure 4-6 RS485 wiring terminals for the SUN8000

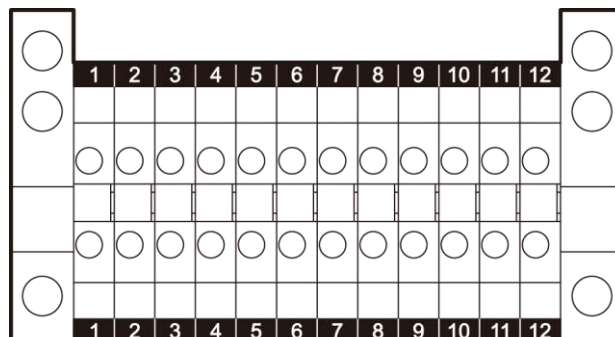

IU012C0001

Ports 07, 08, 09, 10, 11, and 12 are communications ports. [Table 4-4](#) describes the functions of these ports.

Table 4-4 Port description

| No. | Function | Description |
|-----|-----------|--|
| 07 | S485A | RS485A, RS485 differential signal + (reserved) |
| 08 | S485B | RS485B, RS485 differential signal - (reserved) |
| 09 | N485A_OUT | RS485A, RS485 differential signal + |
| 10 | N485A_IN | RS485A, RS485 differential signal + |
| 11 | N485B_OUT | RS485B, RS485 differential signal - |
| 12 | N485B_IN | RS485B, RS485 differential signal - |

There are three RS485 ports in the SmartLogger. For the port descriptions, see **Context** in [4.2.1 Connecting the SmartLogger to the SUN2000](#).

[Figure 4-7](#) shows how to connect the SmartLogger to the SUN8000.

Figure 4-7 Connecting the SmartLogger to the SUN8000

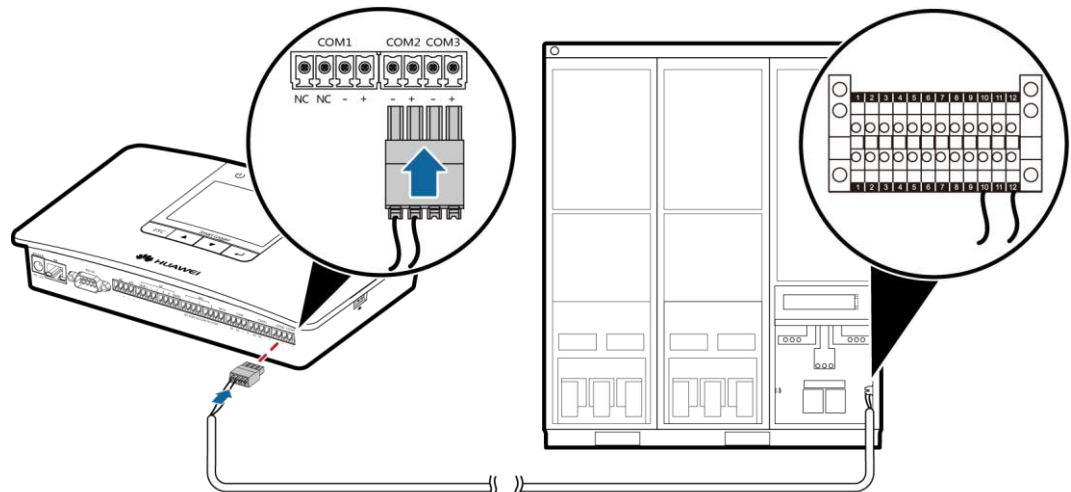

IL011C3003

Procedure

- Step 1** Configure a shielded network cable with an appropriate length. Connect two core wires of the cable to the N485A_IN and N485B_IN ports of the RS485 port for the SUN8000.

- Recommended communications cable: dual-core shielded network cable (outdoor shielded network cables are also acceptable, if only two core wires are connected).
- For details about connecting the RS485 ports for the SUN8000, see the *SUN8000-500KTL User Manual*.

Step 2 Use a wire stripper to peel off 15 mm long of the external insulation layer on the dual-core shielded network cable.

Step 3 Use a wire stripper to peel off 10 mm long of the internal insulation layer on the two core wires of the shielded network cable.

Step 4 After connecting the core wires to the terminal block, connect the terminal block to the SmartLogger. For details, see [Step 4](#) and [Step 5](#) in [4.2.1 Connecting the SmartLogger to the SUN2000](#).

Insure that the core wire connected to the SUN8000 N485A_IN connects to the **COM+** port and that the core wire connected to the SUN8000 N485B_IN connects to the **COM-** port.

Step 5 Ensure that the cable is correctly connected and secured. Set **Baud rate** for the SUN8000 and the SmartLogger and ensure that the parameters for these two devices are consistent.

- For details about how to set the communications parameters for the SmartLogger, see [6.2.22 Setting Communications Parameters](#).
- For how to set the communications parameters for the SUN8000, see the *SUN8000-500KTL User Manual*.

----End

Follow-up Procedure

Take operations in reversed order to disconnect the SmartLogger from the SUN8000.

4.2.3 Connecting Multiple Inverters to the SmartLogger

This topic describes how to connect the SmartLogger to multiple inverters.

Connect the SmartLogger to multiple inverters in daisy chain, that is, first connect the RS485OUT port of one inverter to the RS485IN port of another inverter and then connect the first inverter to the SmartLogger, as shown in [4.2.1 Connecting the SmartLogger to the SUN2000](#) or [4.2.2 Connecting the SmartLogger to the SUN8000](#). [Figure 4-8](#) shows the daisy chain connecting the SmartLogger and multiple inverters.

Figure 4-8 Connecting Multiple Inverters to the SmartLogger

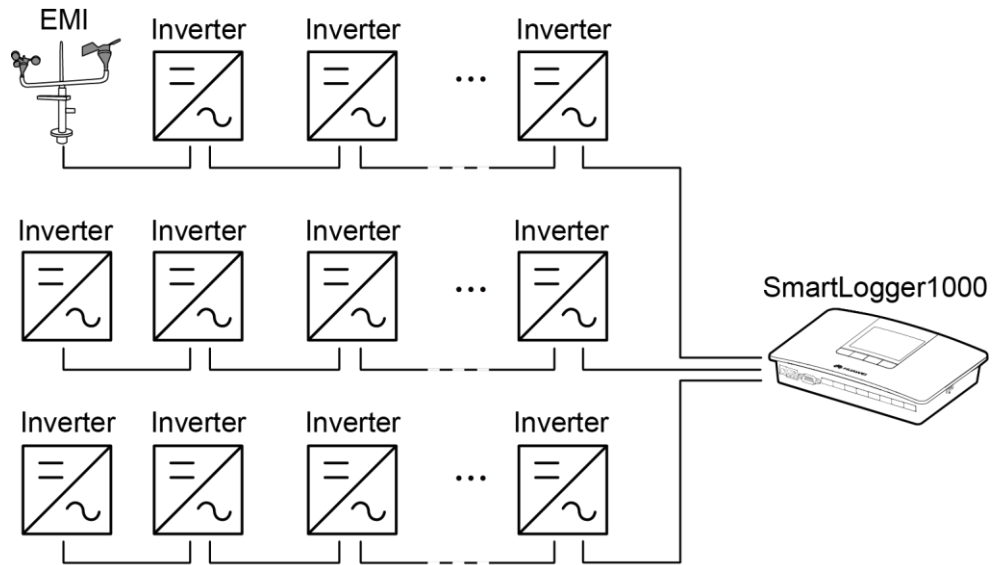

IL01NC0001

NOTE

- A maximum of 80 devices can be connected to one SmartLogger. You are advised to connect less than 30 devices to each RS485 route.
- If an EMI is to be connected, connect it at the end of the chain. Set the address for the EMI to 1.
- Set **Match Resistance** of every inverter at the end of the daisy chain to **Connect** in **Comm. Param.**. For details about this, see the *SUN2000 (8KTL-28KTL) User Manual*.
- The addresses for all devices in the daisy chain should be within the searching scope set in the SmartLogger and they must differ from each other. Otherwise, the communications would fail between the device and the SmartLogger.
- If the firmware version of the SUN2000 is V100R001C00SPC010 or later, you can perform **Addr. Allocate** on the SmartLogger. If detecting that an RS485 address is repeatedly used, the SmartLogger automatically allocates another address and hence no local operation is required.
- **Baud rate** of all the devices in one daisy chain should stay consistent with those of the SmartLogger.

4.3 Connecting to an EMI

This topic describes how to connect the SmartLogger to an environmental monitoring instrument (EMI).

Context

The SmartLogger can be connected to an EMI that complies with the standard MODBUS/RS485 protocol. One SmartLogger can be connected to and manage only one EMI.

Devices from different vendors may support different protocols. To normally obtain information from the connected EMI, correctly configure the protocol on the WebUI of the SmartLogger based on the document delivered by the vendor.

For the definition of the RS485 communications cable for the EMI, see the instructions delivered with the EMI.

There are three RS485 ports in the SmartLogger. For the port descriptions, see **Context** in [4.2.1 Connecting the SmartLogger to the SUN2000](#).

[Figure 4-9](#) shows how to connect the SmartLogger to the EMI.

Figure 4-9 Connecting the SmartLogger to the EMI

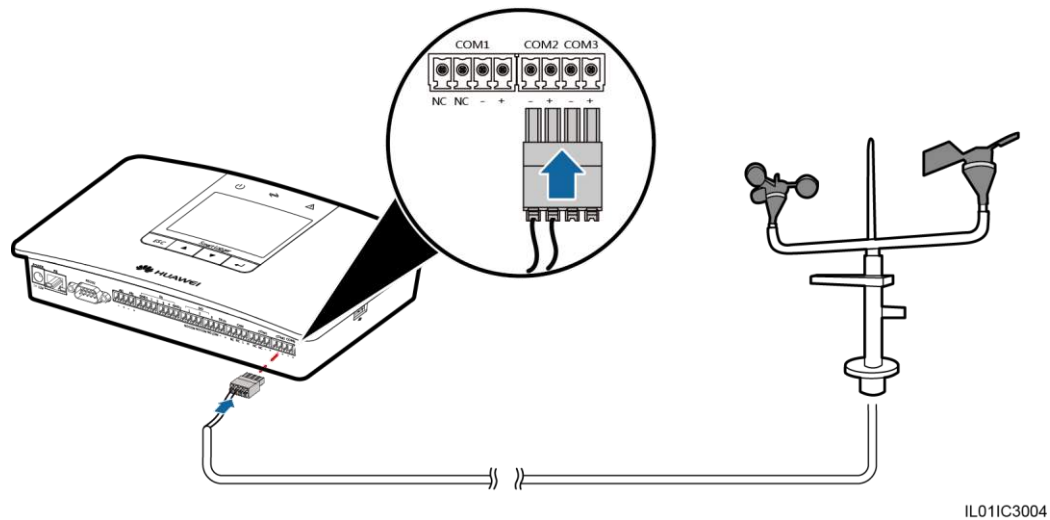

Procedure

- Step 1** Connect one end of the cable delivered with the EMI to the RS485 port of the unit.
- Step 2** Connect the other end of the cable to the COM port of the SmartLogger. For details about this operation, see **Procedure** in [4.2.1 Connecting the SmartLogger to the SUN2000](#).



NOTICE

- Connect the RS485+ port of the EMI to the **COM+** port of the SmartLogger and connect the RS485- port of the EMI to the **COM-** port of the SmartLogger.
- After connecting the cable, log in to the WebUI and set parameters under **EMI**. For details about this operation, see [7.26 Setting EMI Parameters](#).
- The EMI cannot be detected automatically. You need to add this device manually. For details about this operation, see [6.2.29 Managing Devices](#).
- When the SmartLogger is connected to an EMI and multiple inverters at the same time, connect the EMI to the end of the daisy chain. For details, see [4.2.3 Connecting Multiple Inverters to the SmartLogger](#).

----End

Follow-up Procedure

Take the reverse steps to disconnect the SmartLogger from the EMI.

4.4 Connecting the SmartLogger to a Power Meter

This topic describes how to connect the SmartLogger to a Power Meter.

Context

Connect the SmartLogger to a Power Meter that complies with the standard MODBUS/RS485 protocol. The SmartLogger can connect to and manage only one Power Meter at a time.

The protocol points for Power Meters provided by different vendors are varied. Therefore, to obtain information from a Power Meter, configure the protocol point on the WebUI of the SmartLogger properly based on the document delivered by the vendor.

For details about the definition of the RS485 communications cables for the Power Meter, see the operation manual delivered with the Power Meter.

There are three RS485 ports in the SmartLogger. For details about the port descriptions, see **Context** in [4.2.1 Connecting the SmartLogger to the SUN2000](#).

[Figure 4-10](#) shows how to connect the SmartLogger to the Power Meter.

Figure 4-10 Connecting the SmartLogger to a Power Meter

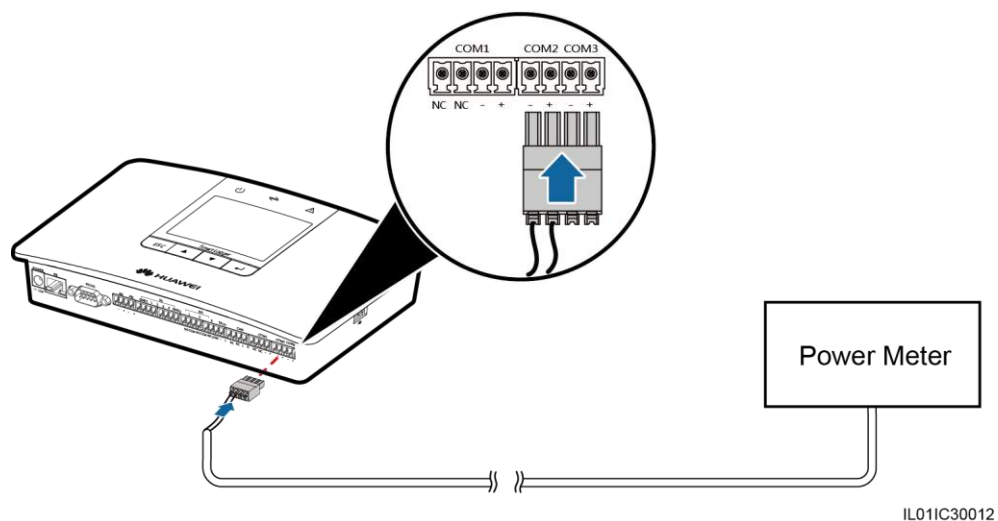

Procedure

- Step 1** Connect one end of the shielded network cable delivered together with the Power Meter to the RS485 port.
- Step 2** Connect the other end to the COM port in the SmartLogger. For details about the operation, see the **Procedure** in [4.2.1 Connecting the SmartLogger to the SUN2000](#).



NOTICE

- Connect the RS485+ port of the Power Meter to the **COM+** port of the SmartLogger and the RS485- port of the Power Meter to the **COM-** port of the SmartLogger.
- After connecting the cable, log in to the WebUI and set parameters under **Power Meter**. For details about this operation, see [7.27 Setting Power Meter Parameters](#).
- The Power Meter cannot be detected automatically. You need to add this device manually. For details about this operation, see [6.2.29 Managing Devices](#).

----End

Follow-up Procedure

Take operations in reversed order to disconnect the SmartLogger from the Power Meter.

4.5 Connecting to an AC Combiner Box

This section describes how to connect the SmartLogger to an AC combiner box.

Context

The SmartLogger can be connected to an AC combiner box that complies with the Modbus/RS485 protocol.

[Figure 4-11](#) shows the communications terminals of a Huawei AC combiner box.

Figure 4-11 Communications ports

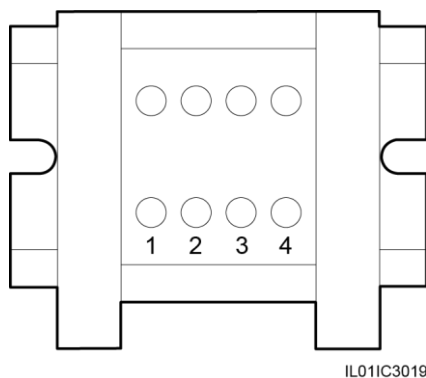

[Table 4-5](#) describes the ports.

Table 4-5 Port description

| No. | Function | Description |
|-----|----------|-----------------------------|
| 1 | RS485A | RS485 differential signal + |
| 2 | RS485B | RS485 differential signal - |

| No. | Function | Description |
|-----|----------|-----------------------------|
| 3 | RS485A | RS485 differential signal + |
| 4 | RS485B | RS485 differential signal - |

For the descriptions of RS485 communications ports of a third-party AC combiner box, see the operation guide delivered with the combiner box.

There are three RS485 ports in the SmartLogger. For the port descriptions, see **Context** in [4.2.1 Connecting the SmartLogger to the SUN2000](#).

[Figure 4-12](#) shows how to connect the SmartLogger to the AC combiner box.

Figure 4-12 Connecting the SmartLogger to the AC combiner box

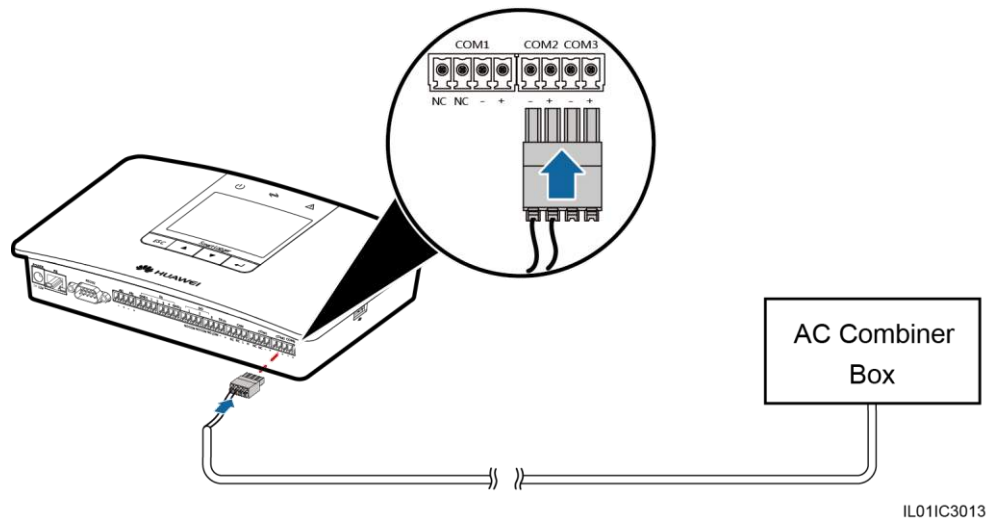

Procedure

- Step 1** Connect one end of the communications cable (a shielded network cable is recommended) to the RS485 port of the AC combiner box.
- Step 2** Connect the other end of the cable to the COM port of the SmartLogger. For details about this operation, see **Procedure** in [4.2.1 Connecting the SmartLogger to the SUN2000](#).



NOTICE

- Connect the RS485+ port of the AC combiner box to the **COM+** port of the SmartLogger and connect the RS485- port of the AC combiner box to the **COM-** port of the SmartLogger.
- AC combiner boxes from Huawei can be automatically detected. Those from other vendors cannot be detected automatically, and you need to add them manually. For details about this operation, see [6.2.29 Managing Devices](#).

----End

Follow-up Procedure

Take the reverse steps to disconnect the SmartLogger from the AC combiner box.

4.6 Connecting to a PLC

This topic describes how to connect the SmartLogger to a PLC.

Context

The RS485 port of a PLC is an RJ45 port that should be connected to an RJ45 connector, as shown in [Figure 4-13](#).

Figure 4-13 PLC RS485 port connection (side view without the fastener)

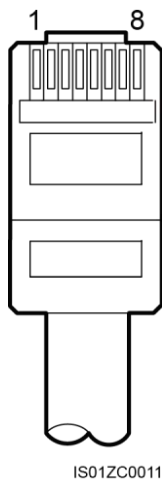

[Table 4-6](#) lists the cable colors and functions.

Table 4-6 Cable colors and functions

| No. | Color | Function |
|-----|------------------|----------|
| 1 | White and orange | Reserved |

| No. | Color | Function |
|-----|-----------------|---|
| 2 | Orange | Reserved |
| 3 | White and green | 12 Vin, power |
| 4 | Blue | RS485A, and RS485 differential signal + |
| 5 | White and blue | RS485B, and RS485 differential signal - |
| 6 | Green | Reserved |
| 7 | White and brown | Reserved |
| 8 | Brown | PGND |

There are three RS485 ports in the SmartLogger. For the port descriptions, see **Context** in [4.2.1 Connecting the SmartLogger to the SUN2000](#).

[Figure 4-14](#) shows how to connect the SmartLogger to the PLC.

Figure 4-14 Connecting the SmartLogger to the PLC

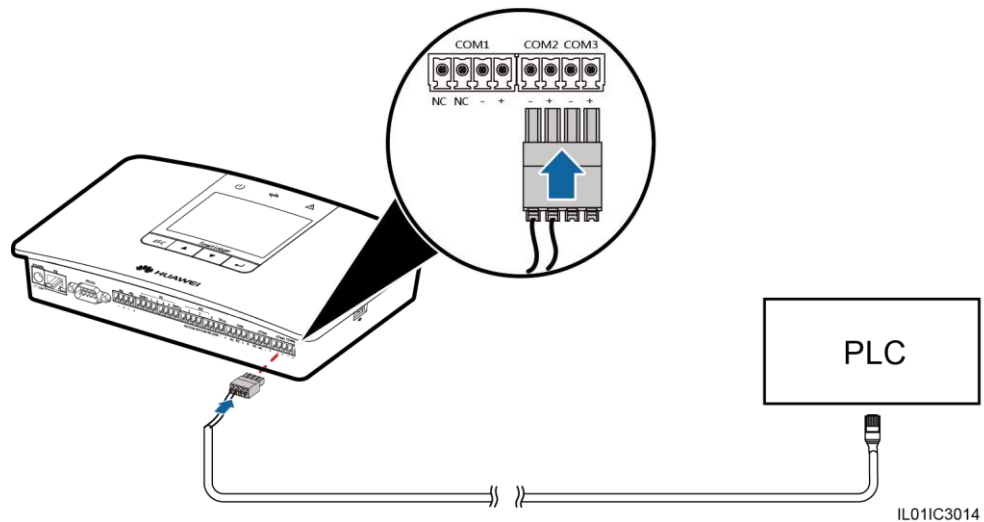

Procedure

- Step 1** Choose a shielded network cable of appropriate length. Crimp an RJ45 connector at one end and connect it to the RS485 port of the PLC.
- Step 2** Connect the other end of the cable to the COM port of the SmartLogger. For details about this operation, see **Procedure** in [4.2.1 Connecting the SmartLogger to the SUN2000](#).



NOTICE

- Connect the RS485+ port of the PLC to the **COM+** port of the SmartLogger and connect the RS485- port of the PLC to the **COM-** port of the SmartLogger.
- The PLC cannot be detected automatically. You need to add this device manually. For details about this operation, see [6.2.29 Managing Devices](#).
- The Huawei PLC supports auto-negotiation of baud rate 9600 bps/115200 bps. If the PLC networking is used, you are advised to set **Baud rate** to **115200bps** for the RS485 ports of the SmartLogger to achieve better communication performance.

----End

Follow-up Procedure

Take the reverse steps to disconnect the SmartLogger from the PLC.

4.7 Connecting the SmartLogger to a PC

This topic describes how to connect the SmartLogger to a PC.

Procedure

Step 1 Connect one end of the network cable delivered together with the SmartLogger to its **FE** port.



NOTE

If the delivered network cable is shorter than the required length, note the following when preparing network cable:

- Choose CAT 5E or above shielded network cables.
- It is suggested that the cable length is less than or equal to 100 meters.

Step 2 Connect the other end to the network port of the PC, as shown in [Figure 4-15](#).

Figure 4-15 Connecting the SmartLogger to a PC

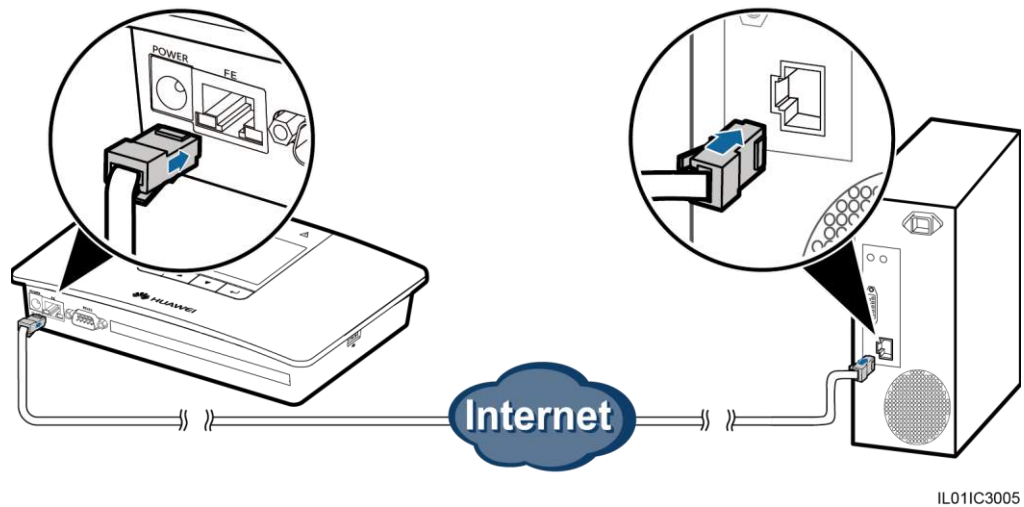

 **NOTE**

The default IP address for the SmartLogger is 192.168.0.10; its default subnet mask is 255.255.255.0; its default gateway is 192.168.0.1.

- If the SmartLogger connects to the PC directly or through a Hub, set their IP addresses to be in the same network segment. For example, if the IP address for the SmartLogger is 192.168.0.10, the IP address for the PC can be 192.168.0.11. The subnet mask and the gateway of the PC should stay consistent with those of the SmartLogger.
- If the SmartLogger connects to the PC through a network device (for example, a router), set the IP addresses for the SmartLogger and network device to be in the same network segment. Correctly set the gateway of the SmartLogger to ensure that the SmartLogger can normally communicate with the network device.
- To enable communication between the SmartLogger and the NetEco on the PC, set the NetEco parameters properly. For details, see [6.2.22 Setting Communications Parameters](#).

----End

Follow-up Procedure

Take operations in reversed order to disconnect the SmartLogger from the PC.

4.8 Connecting to a PID

This section describes how to connect the SmartLogger to a PID.

Context

There are three RS485 ports in the SmartLogger. For the port descriptions, see **Context** in [4.2.1 Connecting the SmartLogger to the SUN2000](#).

[Figure 4-16](#) shows how to connect the SmartLogger to the PID.

Figure 4-16 Connecting the SmartLogger to the PID

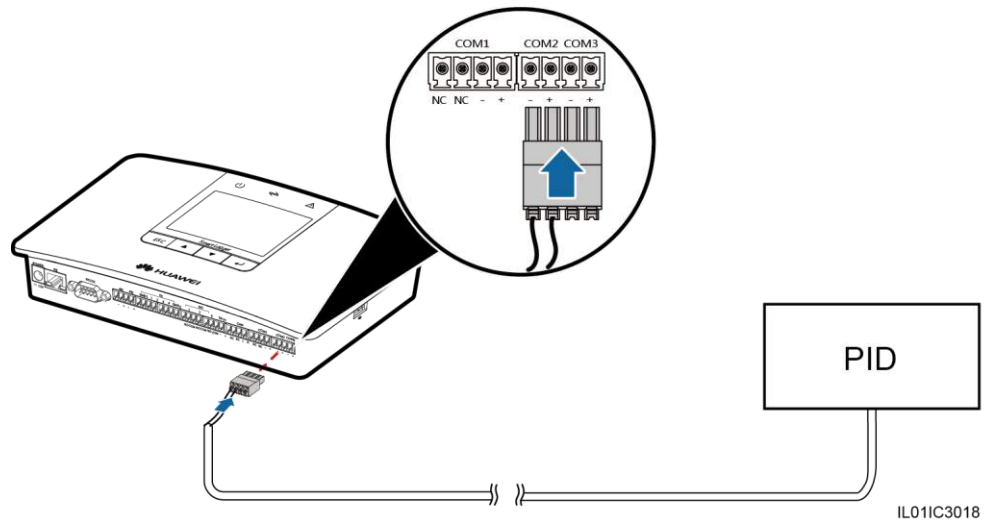

Procedure

- Step 1** Connect one end of the cable delivered with the PID to the RS485 port of the PID.
- Step 2** Connect the other end of the cable to the COM port of the SmartLogger. For details about this operation, see **Procedure** in [4.2.1 Connecting the SmartLogger to the SUN2000](#).



NOTICE

When connecting the cable, verify that the brown cable core (RS485A) and black cable core (RS485B) are respectively connected to the COM+ and COM- ports of the SmartLogger.

----End

Follow-up Procedure

Take the reverse steps to disconnect the SmartLogger from the PID.

4.9 Connecting the SmartLogger to a Ripple Control Receiver

This topic describes how to connect the SmartLogger to a ripple control receiver.

Context

In Germany and some European areas, a ripple control receiver is used to convert a power grid scheduling signal to a dry contact signal, in which a dry contact is required.

[Figure 4-17](#) shows the DI ports on the SmartLogger.

Figure 4-17 DI ports in the SmartLogger

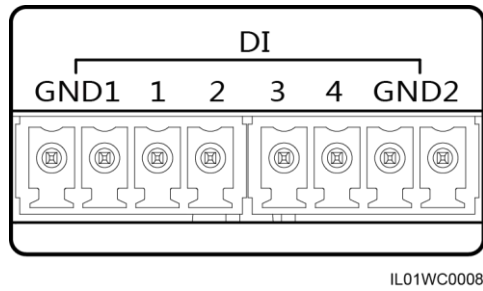

Table 4-7 describes the definition of the DI ports.

Table 4-7 DI port description

| Port | Functions |
|------|-----------------------------|
| GND1 | Active power reduction |
| 1 | DI_1 |
| 2 | DI_2 |
| 3 | DI_3 |
| 4 | DI_4 |
| GND2 | Reactive power compensation |

Figure 4-18 shows how to connect the Smart Logger to the ripple control receiver.

Figure 4-18 Connecting the SmartLogger to a Ripple Control Receiver

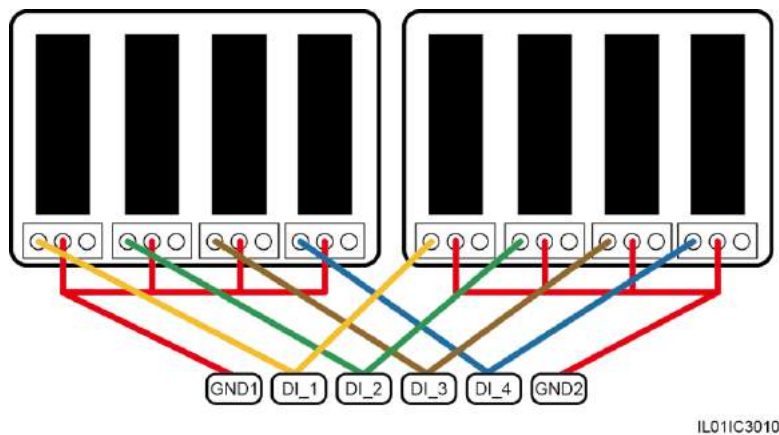



NOTICE

When active power remote control and reactive power remote control are supported, only one out of the four outputs of each ripple control receiver can be closed

Procedure

- Step 1** Select a cable of appropriate length and connect one end of a cable to the ripple control receiver.
- Step 2** Connect the other end to the DI port in the SmartLogger. For details about the operation, see **Procedure** in [4.2.1 Connecting the SmartLogger to the SUN2000](#).



NOTICE

To enable a normal power grid scheduling function, you need to set the corresponding parameters (Active Power Control or Reactive Power Control) on the embedded WebUI. For details, see [8.1.1 Active Power Control](#) or [8.1.2 Reactive Power Control](#).

----End

Follow-up Procedure

Take operations in reversed order to disconnect the SmartLogger from the ripple control receiver.

5 System Operation

This topic describes how to start the SmartLogger and set the initialization parameters.

5.1 Power-on Process

This section describes how to check the SmartLogger before power-on and how to power on the SmartLogger.

Checking Before Powering On the SmartLogger

Check and ensure the following before powering on the SmartLogger.

- All cables are intact and well insulated.
- All cables are of proper size.
- All cables are correctly connected and secured.

Power-on Process

Power on the devices in the following sequence: Inverter > SmartLogger > PC terminal.



NOTE

The PC terminal refers to a PC where the NetEco1000 is installed.

| Step | Operation |
|------|--|
| 1 | Perform the requirements mentioned in Checking Before Powering On the SmartLogger . |
| 2 | Start the inverter and correctly set the communications parameters (including Address , and Baud rate) on the monitoring panel. For details about how to set the communications parameters, refer to Setting Communications Parameters in the <i>SUN2000 (8KTL-28KTL) User Manual</i> and <i>SUN8000-500KTL User Manual</i> . |
| 3 | Connect the output terminal of the power adapter for the SmartLogger to the power port POWER and the input terminal to the AC socket. |

| Step | Operation |
|------|--|
| 4 | <p>Set the search address segment and baud rate for the RS485 port on the SmartLogger monitoring panel.</p> <p>If the SmartLogger is powered on for the first time, set the search address segment and baud rate for the RS485 port in the Wizard, as shown in 5.2 Setting Initialization Parameters. If it is not powered on for the first time, set the parameters in the Comm. Param. under the Settings, as shown in 6.2.22 Setting Communications Parameters.</p> |
| 5 | <p>Wait for the SmartLogger to search for inverters. After the search is completed, the SmartLogger automatically connects to all inverters.</p> <p>Alternatively, you can skip this operation and manually search for, add, or delete inverters in follow-up operations. For details, see 6.2.29 Managing Devices.</p> |
| 6 | <p>(Optional) Manually add an environment monitoring instrument, power meter, PLC, or third-party device.</p> <p>For details, see 6.2.29 Managing Devices.</p> <p>NOTICE</p> <p>Before adding an environment monitoring instrument or power meter, log in to the WebUI and correctly set parameters for the device to be added. Before adding a third-party device, import a correct configuration file for the device.</p> |
| 7 | <p>(Optional) Start the PC terminal and set Ethernet and NetEco parameters on the SmartLogger.</p> |



NOTICE

- When starting the SmartLogger, use only the 12 V power adapter shipped along with the shell. If adapters of other models are used, the SmartLogger may be damaged.
- Log in to the SmartLogger on the monitoring panel. When you log in to the **Settings** page or **Maintenance** page, an identity authentication is required. The initial password is *000001*. Change the password as soon as possible to ensure the security of the user account. For details about how to change the password, refer to [6.2.21 Changing a Password](#).

5.2 Setting Initialization Parameters

When starting the SmartLogger for the first time, set initialization parameters on the monitoring panel. The initialization parameters include system language, system time, the search address segment for the RS485 port, and the Ethernet parameters.

Context











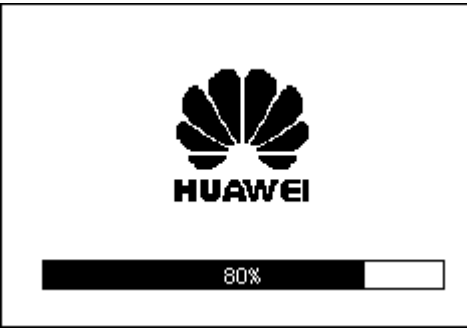
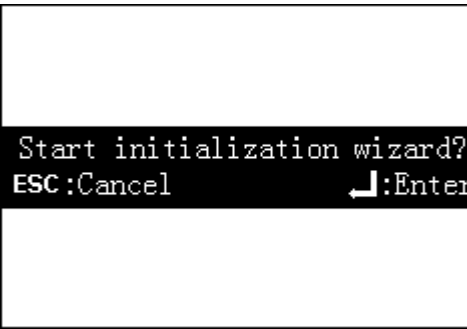

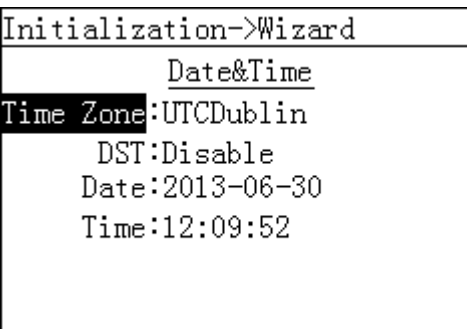

NOTE

If the SmartLogger is started for the first time, set the initialization parameters by referring to this section. If it is not started for the first time, it directly performs the automatic search and then the default page.

Procedure

- The following table describes the process for setting initialization parameters. The parameter values in the following figures are for reference only.

| LCD | Operation Procedure |
|---|--|
|  | <p>1. After startup, the SmartLogger enters the initialization page.</p> <p>The default system language is English.</p> |
|  | <p>2. Press  to enter the Wizard page.</p> <p>To return to the default page, press ESC. If some later re-settings are required, refer to 6.2.17 Setting the System Language, 6.2.18 Setting System Time Parameters, and 6.2.22 Setting Communications Parameters.</p> |
|  | <p>3. Select a display language and then press .</p> <p>The pages will be displayed in the selected language.</p> |
|  | <p>4. Set the correct date and time and then press .</p> <ul style="list-style-type: none"> To select the specific parameter, press . To set the parameter value, press  or . <p>The date and time are displayed in the formats of YYYY-MM-DD and hh:mm:ss respectively. YYYY stands for the year, MM the month, DD the date, hh the hour, mm the minute, and ss the second.</p> <p>NOTICE</p> <p>After the Time is successfully set, this time can be synchronized in all the inverters connected to the SmartLogger.</p> |

| LCD | Operation Procedure |
|---|--|
| <pre>Initialization->Wizard Ethernet IP Address:192.168. 0. 10 Subnet Mask:255.255.255. 0 Gateway:192.168. 0. 1 DNS-1:192.168. 8. 1 DNS-2: 0. 0. 0. 0 Submit</pre> | <p>5. Set the Ethernet parameters and then press .</p> <p>The following Ethernet parameters are to be set: IP address, Subnet mask, Gateway and DNS.</p> |
| <pre>Initialization->Wizard Search Address Segments RS485-1:001-020 RS485-2:001-020 RS485-3:001-020</pre> | <p>6. Set the RS485 search address segment and then press .</p> <p>You need to set the search address segments for RS485-1, RS485-2, and RS485-3 respectively.</p> |
| <pre>Initialization->Search Devices Search devices now? ESC:Cancel ↓:Enter</pre> | <p>7. On the page, press .</p> <p>After the search is complete, the SmartLogger displays a search result. Press  to end this operation.</p> |

 **NOTE**

Visiting some menu requires identity authentication. Therefore, after you set the initialization parameters, change the password immediately to ensure the security of the user account. For details, see [Change the Password](#).

----End

6 User Interface

This topic describes the monitoring menu and operations.

6.1 Monitoring Menu Hierarchy

This topic describes the monitoring menu hierarchy, which allows you to perform operations conveniently.

[Figure 6-1](#) shows the monitoring menu hierarchy.

Figure 6-1 Monitoring menu hierarchy (1)

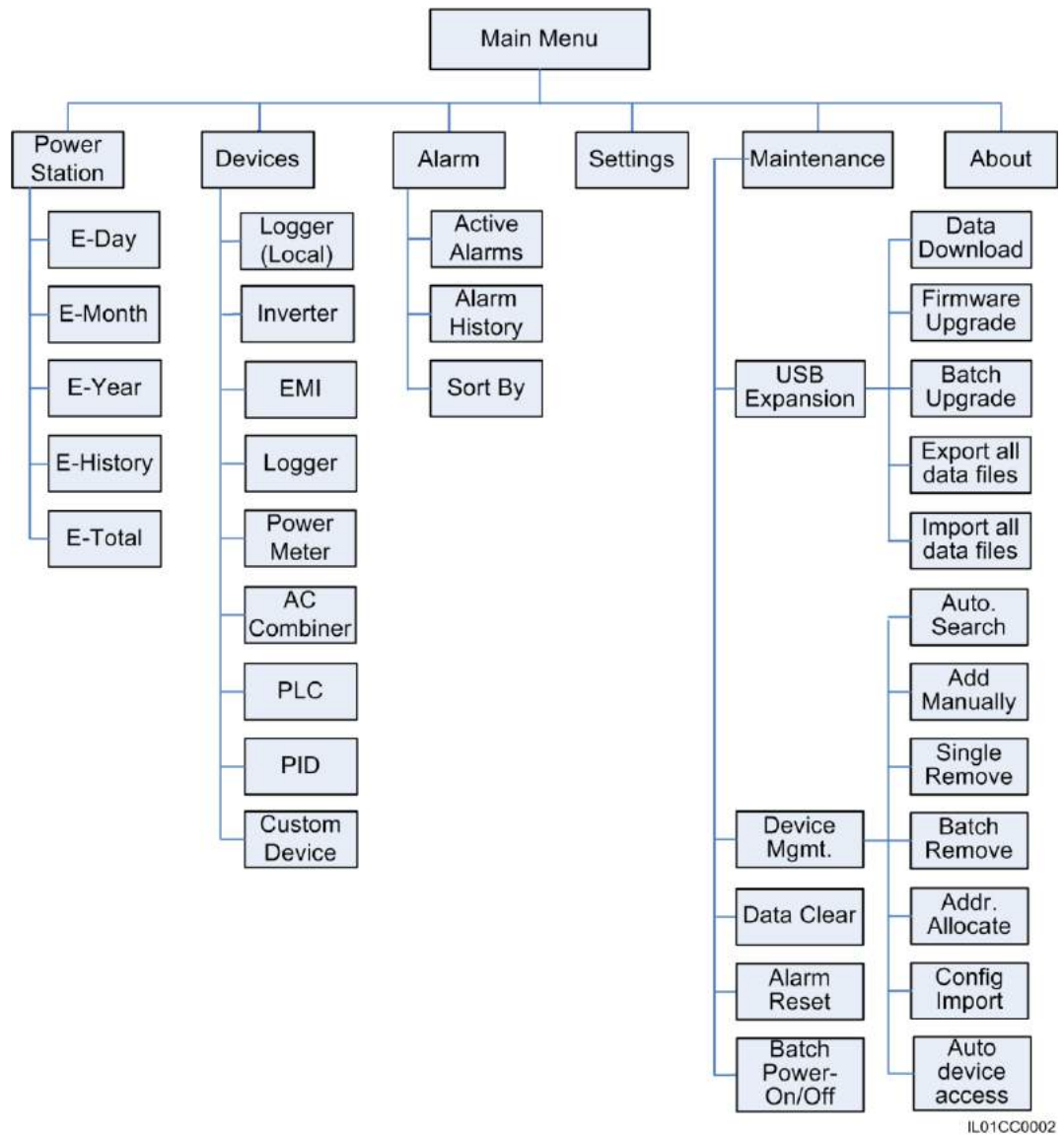

 **NOTE**

If you access the **Maintenance** menu as a **Common User**, the message "Current user has no authority" is displayed.

Different identities (Common User, Advanced User, and Special User) have different permissions for setting parameters. The hierarchies of **Settings** are shown in [Figure 6-2](#).

 **NOTICE**

The initial password for **Common User**, **Advanced User** and **Special User** is *000001*. If the SmartLogger is logged in for the first time, use the initial password to log in and [change the password](#) immediately to ensure the account security.

Figure 6-2 Monitoring menu hierarchy (2)

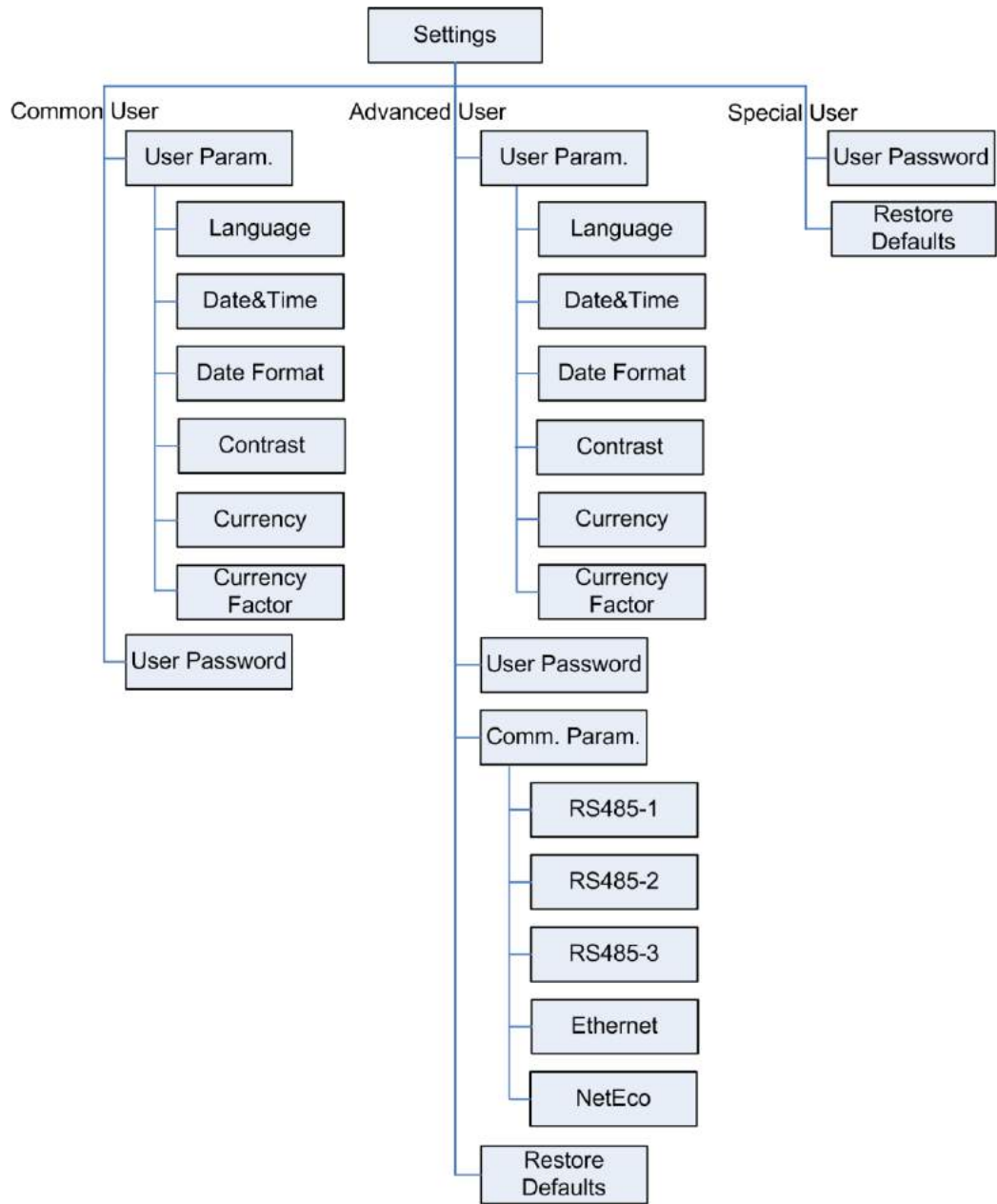

IL01CC0003

6.2 Monitoring Operations

This topic describes how to operate on the monitoring panel, such as querying site and device information and setting system parameters and user parameters.

6.2.1 Querying Power Station Information

This topic describes how to view the power station information on the monitoring panel of the SmartLogger, such as the daily, monthly, yearly, historical, and total energy yield.

Procedure

- The following table describes the procedure for viewing power station information. The parameter values in the following figures are for reference only.



NOTICE

You can view the daily, monthly, yearly, and historical energy yields of the power station. The values relate to the number of connected inverters.

- Daily energy yield. Data of a maximum of 80 devices can be stored for 34 days.
- Monthly energy yield. Data of a maximum of 80 devices can be stored for 27 months.
- Yearly energy yield. Data of a maximum of 80 devices can be stored for 25 years.
- Historical energy yield. Data of a maximum of 80 devices can be stored for 25 years.

| LCD | Operation Procedure |
|-----|--|
| | <p>1. On the default page, press to enter the main menu.</p> |
| | <p>2. Choose and press .</p> |
| | <p>3. Press and to view the running data of the power station.</p> <p>The running data includes the daily, monthly, yearly, historical, and total energy yield. For details, see step 4 to step 8.</p> |

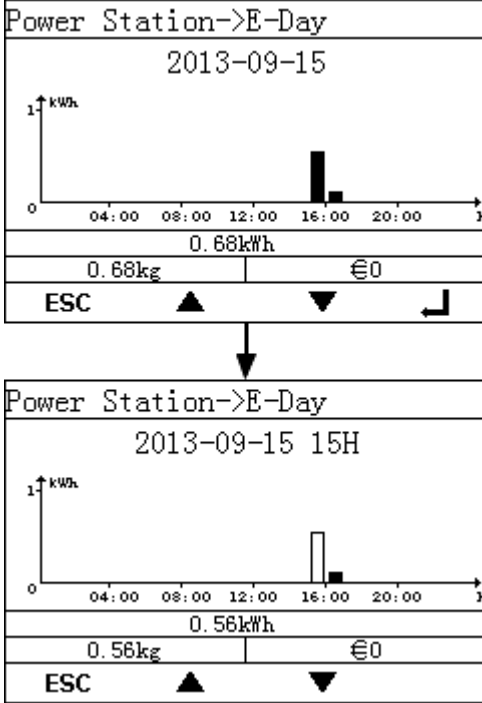
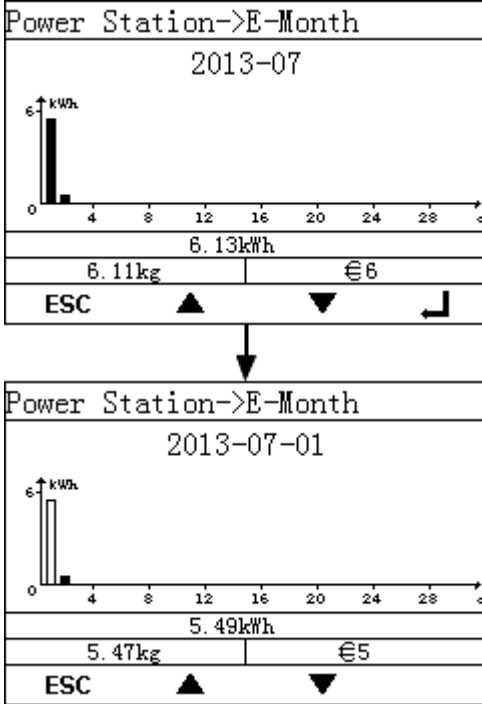
| LCD | Operation Procedure |
|---|--|
|  <p>Power Station->E-Day 2013-09-15 0.68kWh 0.68kg €0 ESC</p> <p>Power Station->E-Day 2013-09-15 15H 0.56kWh 0.56kg €0 ESC</p> | <p>4. View the daily energy yield.</p> <p>a. On the E-Day page, view the total energy yield and hourly energy yield of the power station on the current day.</p> <p>The displayed information includes the energy yield histogram, date, total energy yield on the current day, CO₂ emission reduction, and revenue.</p> <p>To view the energy yield in the past 30 days (including the current day), press ▲ or ▼.</p> <p>NOTE In the daily energy yield histogram, the horizontal axis stands for time (each block stands for one hour). The vertical axis stands for the total energy yield of all the inverters connected to the SmartLogger (each block stands for the total energy yield during the last hour).</p> <p>b. Press ← to view the energy yield of a specific hour on the current day. To switch between hours, press ▲ or ▼.</p> <p>NOTE The selected block is displayed in white.</p> |
|  <p>Power Station->E-Month 2013-07 6.13kWh 6.11kg €6 ESC</p> <p>Power Station->E-Month 2013-07-01 5.49kWh 5.47kg €5 ESC</p> | <p>5. View the monthly energy yield.</p> <p>a. On the E-Month page, view the total energy yield and daily energy yield in the current month.</p> <p>The displayed information includes the energy yield histogram, Month, total energy yield of the current month, CO₂ emission reduction, and revenue.</p> <p>To view the energy yield in the past 12 months (including the current month), press ▲ or ▼.</p> <p>NOTE In the monthly energy yield histogram, the horizontal axis stands for day (each block stands for one day). The vertical axis stands for the total energy yield of all the inverters connected to the SmartLogger (each block stands for the total energy yield on that day).</p> <p>b. Press ← to view the energy yield on a specific day of the current month. To switch between days, press ▲ or ▼.</p> <p>NOTE The selected block is displayed in white.</p> |

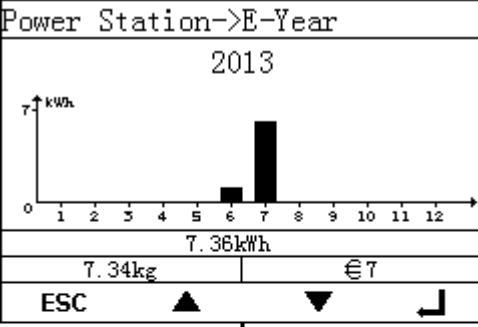
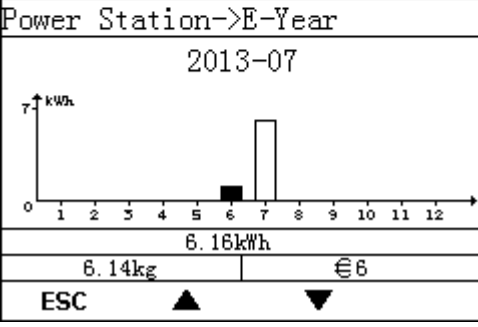
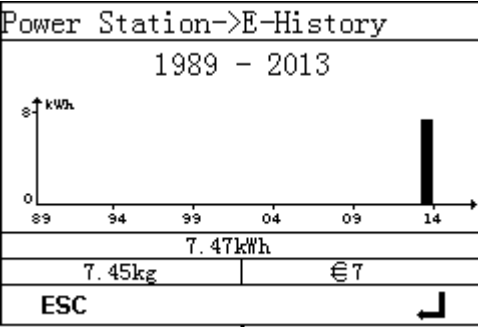
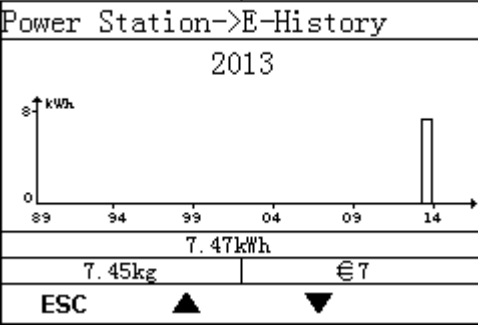
| LCD | Operation Procedure |
|--|--|
| <p>Power Station->E-Year</p>  <p>2013</p> <p>7.36kWh</p> <p>7.34kg €7</p> <p>ESC ▲ ▼ ↵</p> <p>Power Station->E-Year</p>  <p>2013-07</p> <p>6.16kWh</p> <p>6.14kg €6</p> <p>ESC ▲ ▼</p> | <p>6. View the yearly energy yield.</p> <p>a. On the E-Year page, view the total energy yield and daily energy yield in the current month.</p> <p>The displayed information includes the energy yield histogram, Year, total energy yield of the current month, CO₂ emission reduction, and revenue.</p> <p>To view the energy yield in the past 25 years (including the current year), press ▲ or ▼.</p> <p>NOTE</p> <p>In the yearly energy yield histogram, the horizontal axis stands for month (each block stands for one month). The vertical axis stands for the total energy yield of all the inverters connected to the SmartLogger (each block stands for the total energy yield on that month).</p> <p>b. Press ↵ to view the energy yield on a specific day of the current month. To switch between months, press ▲ or ▼.</p> <p>NOTE</p> <p>The selected block is displayed in white.</p> |
| <p>Power Station->E-History</p>  <p>1989 - 2013</p> <p>7.47kWh</p> <p>7.45kg €7</p> <p>ESC ↵</p> <p>Power Station->E-History</p>  <p>2013</p> <p>7.47kWh</p> <p>7.45kg €7</p> <p>ESC ▲ ▼</p> | <p>7. View the historical energy yield.</p> <p>a. On the E-History page, view the energy yield in the past 25 years (including the current year).</p> <p>The displayed information includes the energy yield histogram, Year, total energy yield, CO₂ emission reduction, and revenue.</p> <p>To view the energy yield in the past 25 years (including the current year), press ▲ or ▼.</p> <p>NOTE</p> <p>In the historical energy yield histogram, the horizontal axis stands for year (each block stands for one year). The vertical axis stands for the total energy yield of all the inverters connected to the SmartLogger (each block stands for the total energy yield on that year).</p> <p>b. Press ↵ to view the energy yield on a specific day of the current month. To switch between years, press ▲ or ▼.</p> <p>NOTE</p> <p>The selected block is displayed in white.</p> |

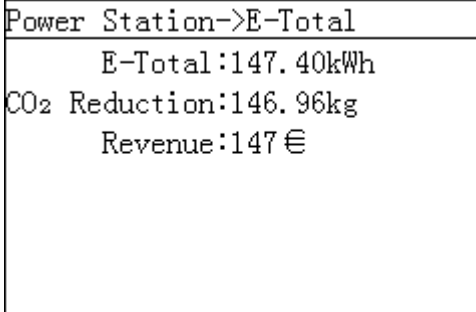
| LCD | Operation Procedure |
|---|--|
|  | <p>8. On the E-Total page, view the total energy yield, CO₂ emission reduction, and revenue of all the devices connected to the SmartLogger.</p> <p>The total energy yield of the devices before they connect to the SmartLogger is also counted in the system after they are connected.</p> |





----End



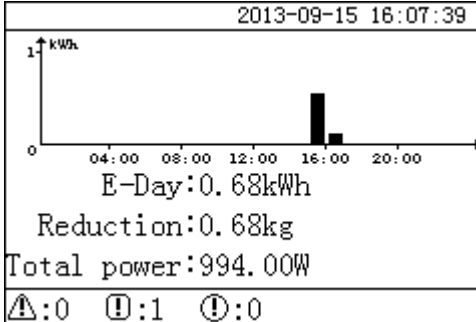

6.2.2 Querying Inverter Information

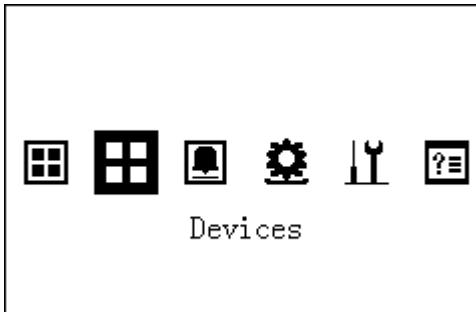

This topic describes how to query the running information and version of each inverter connected to the SmartLogger.

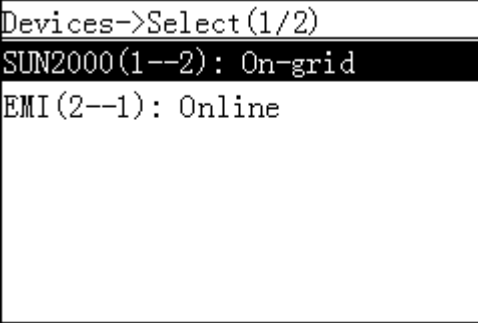
Procedure

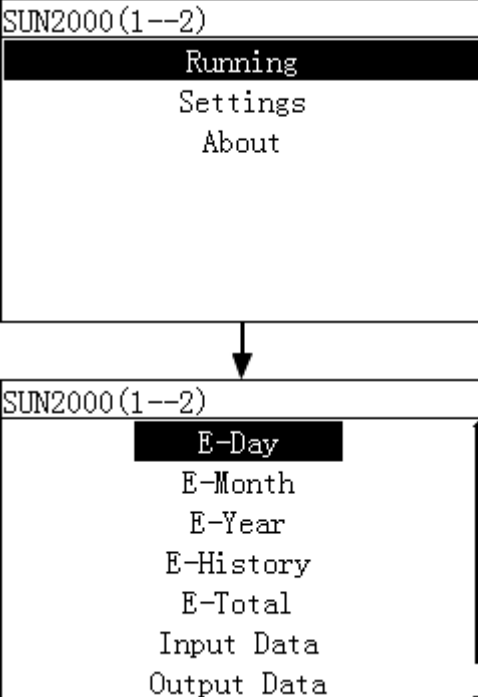
- The following table describes the procedure for viewing inverter information. The parameter values in the following figures are for reference only.

| LCD | Operation Procedure |
|---|---|
|  | <p>1. On the default page, press  to enter the main menu.</p> |
|  | <p>2. Select  and press .</p> |

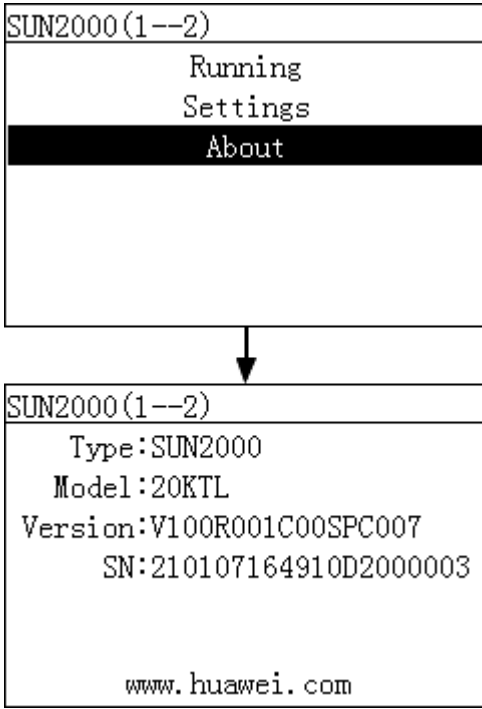
| LCD | Operation Procedure |
|---|--|
|  <p>Devices->Select (1/2) SUN2000(1--2): On-grid EMI (2--1): Online</p> | <p>3. Select an inverter and press .</p> <p>NOTE SUN2000 (1--2) on the left indicates that the inverter connects to Port 1 of the SmartLogger and the communications address of the RS485 port is 2.</p> <p>The device status is displayed behind the device name.</p> <ul style="list-style-type: none"> • Devices Status is any of the following nine values for the SUN8000: Initializing, Idle, Loading, Starting up, On-grid, Shutdown, Disconnection, Detecting ISO, and Debug. • Devices Status is any of the following 6 values for the SUN2000: Starting up, Idle, Loading, On-grid, Shutdown, and Disconnection. <p>The follow-up operations are described as follows:</p> <ul style="list-style-type: none"> • To view the operating data of the inverter, perform step 4. • To view the version of the inverter, perform step 5. |
|  <p>SUN2000(1--2) Running Settings About</p> <p style="text-align: center;">↓</p> <p>SUN2000(1--2) E-Day E-Month E-Year E-History E-Total Input Data Output Data</p> | <p>4. Select Running and press .</p> |

| LCD | Operation Procedure |
|---|--|
|  <p>The LCD screen shows a menu with 'SUN2000(1--2)' at the top, followed by 'Running', 'Settings', and 'About'. The 'About' option is highlighted with a black bar. An arrow points down to a second screen showing device details: 'SUN2000(1--2)', 'Type: SUN2000', 'Model: 20KTL', 'Version: V100R001C00SPC007', 'SN: 210107164910D2000003', and 'www.huawei.com'.</p> | <p>5. Select About and press .</p> |

----End

6.2.3 Manually Powering On or Off the Inverter on the monitoring panel

This topic describes how to power on or off the inverter on the monitoring panel.







Procedure



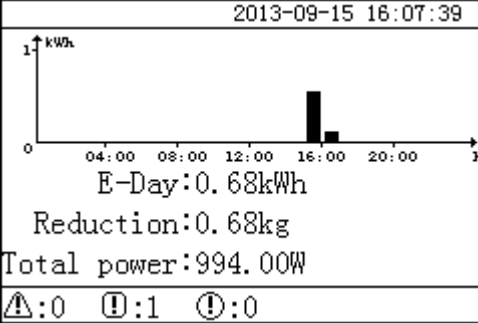

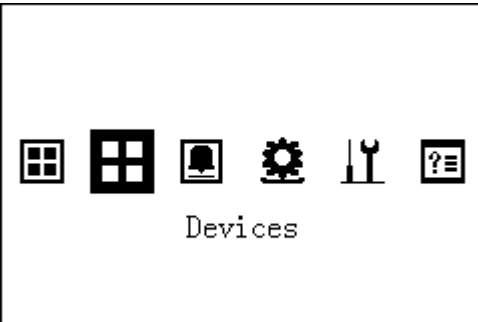
- The following table shows the procedure for powering on or off the inverter on the monitoring panel. The parameter values in the following figures are for reference only.



 **NOTICE**

Choose **Batch Power-On/Off** under **Maintenance** to power on or off all inverters that connect to the SmartLogger.

| LCD | Operation Procedure |
|-----|---------------------|
|-----|---------------------|

| LCD | Operation Procedure |
|---|---|
|  | <p>1. On the default page, press  to enter the main menu.</p> |
|  | <p>2. Choose  and press .</p> |
| <p>Devices->Select (1/2) SUN2000(1--2): On-grid EMI(2--1): Online</p> | <p>3. Select an inverter and press .</p> <p>NOTE SUN2000 (1--2) on the left indicates that the inverter connects to Port 1 of the SmartLogger and the communications address of the RS485 port is 2.</p> |
| <p>SUN2000 (1--7) Running Settings About</p> | <p>4. Choose Settings, and press .</p> |

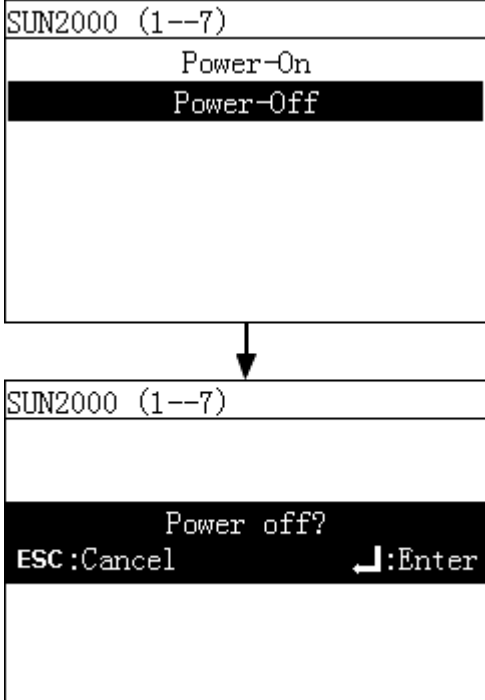
| LCD | Operation Procedure |
|--|--|
| <p>Settings->Login</p> <p>User Name: Advanced User </p> <p>Password: 000000</p> | <p>5. Set the specific User Name and Password.</p> <p>NOTE</p> <p>The following user names can be selected: Common User, Advanced User, and Special User. The initial password for Common User, Advanced User and Special User is <i>000001</i>.</p> |
| <p>SUN2000 (1--7)</p> <p>Power-On/Off</p> | <p>6. Choose Power-On/Off, and press .</p> <ul style="list-style-type: none"> • Perform step 7 if you want to power on the inverter manually. • Perform step 8 if you want to power off the inverter manually. |
| <p>SUN2000 (1--7)</p> <p>Power-On</p> <p>Power-Off</p> <p style="text-align: center;">↓</p> <p>SUN2000 (1--7)</p> <p>Power on?</p> <p>ESC :Cancel :Enter</p> | <p>7. Power on manually.</p> <p>a. Choose Power-On and press .</p> <p>b. Enter  again to verify your settings.</p> |

| LCD | Operation Procedure |
|---|---|
|  | <p>8. Power off manually.</p> <p>a. Choose Power-Off, and press .</p> <p>b. Enter  again to verify your settings.</p> |



----End



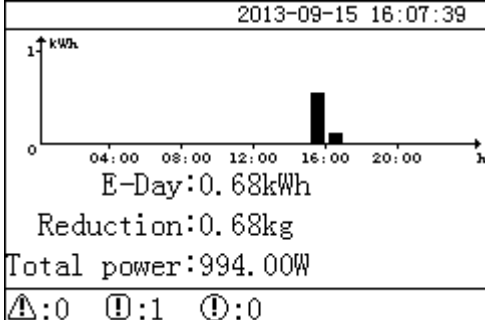

6.2.4 Querying Information about the EMI

This topic describes how to query the EMI information on the monitoring panel.

Procedure

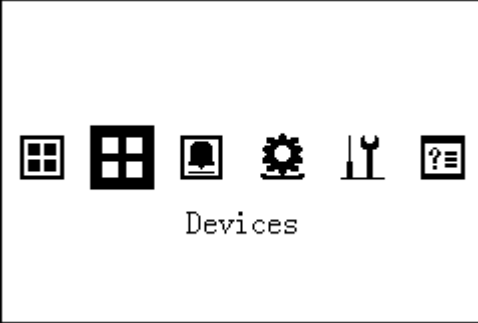
- The following table describes the procedure for querying information about the EMI. The parameter values in the following figures are for reference only.

| LCD | Operation Procedure |
|---|--|
|  | <p>1. On the default page, press  to enter the main menu.</p> |

| LCD | Operation Procedure |
|--|---|
|  | <p>2. Choose  and press .</p> |
| <pre> Devices->Select (7/7) Logger (Local) :Online SUN2000 (2-11) :On-grid SUN2000 (2-12) :On-grid SUN2000 (1-1) :Idle SUN8000 (3-2) :Initializing AC Combiner (3-3) :Online EMI (2-1) :Online </pre> | <p>3. Choose the name of the EMI and press  to view information about the instrument.</p> <p>Devices Status is either of the following values for the EMI: Online and Disconnection.</p> |
| <pre> EMI (2-1) Running </pre> | <p>4. Select Running and press .</p> <ul style="list-style-type: none"> • To view the analog data of the EMI, perform step 5 only. • To view the communications address of the EMI, perform step 6 only. |

| LCD | Operation Procedure |
|---|---|
| <div style="border: 1px solid black; padding: 5px; margin-bottom: 10px;"> <p>EMI (2-1)</p> <div style="border: 1px solid black; padding: 2px; text-align: center;"> <p>Analogue Data</p> </div> <p>Comm. Address</p> </div> <p style="text-align: center;">↓</p> <div style="border: 1px solid black; padding: 5px;"> <p>EMI (2-1)</p> <p>Radiation:0.4W/m²</p> <p>PV temp.:27.8degC</p> <p>Amb. temp.:27.3degC</p> <p>WSP:0.3m/s</p> <p>WD:308(Northwest)</p> </div> | <p>5. Select Analogue Data, and press ↵.</p> |
| <div style="border: 1px solid black; padding: 5px; margin-bottom: 10px;"> <p>EMI (2-1)</p> <div style="border: 1px solid black; padding: 2px; text-align: center;"> <p>Analogue Data</p> </div> <div style="border: 1px solid black; padding: 2px; text-align: center;"> <p>Comm. Address</p> </div> </div> <p style="text-align: center;">↓</p> <div style="border: 1px solid black; padding: 5px;"> <p>EMI (2-1)</p> <p>Port number:2</p> <p>Physical addr.:1</p> <p>Logical addr.:6</p> </div> | <p>6. Select Comm. Address, and press ↵.</p> |







----End

6.2.5 Querying Master SmartLogger Information

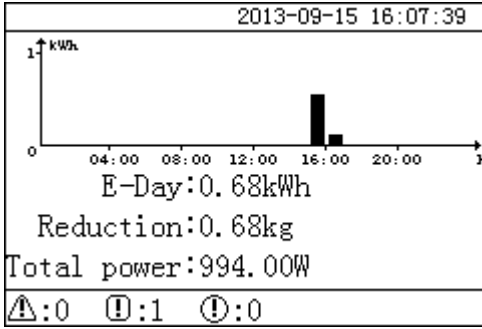
This topic describes how to query Master SmartLogger information.

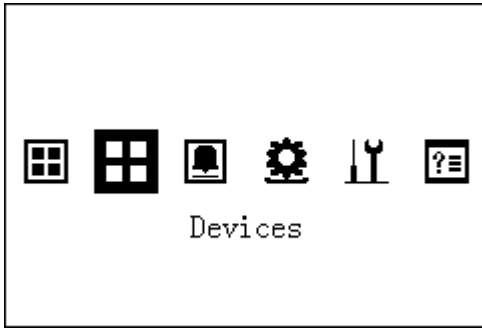
Procedure

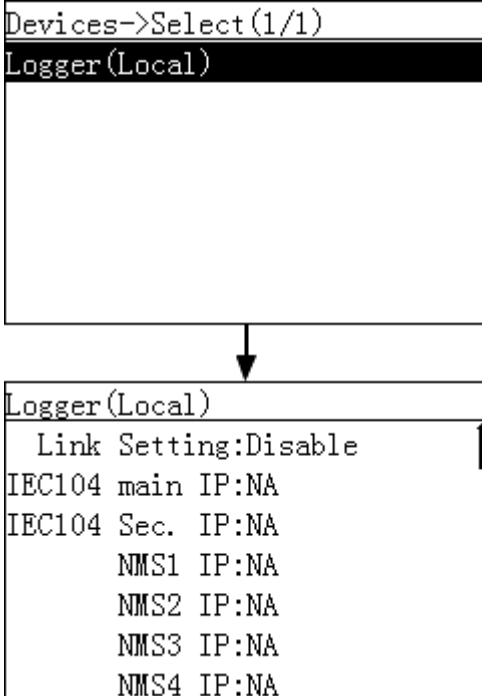
- To query Master SmartLogger information, perform the steps described in the following table. The parameter values in the figures are for reference only.

| LCD | Procedure |
|---|---|
|  | <p>1. On the default page, press  to enter the main menu.</p> |
|  | <p>2. Choose  and press .</p> |
|  | <p>3. Choose Logger (Local) and press  to view the Master SmartLogger information.</p> |

----End

6.2.6 Querying Slave SmartLogger Information

This topic describes how to query Slave SmartLogger information on the monitoring panel.

Context

The Slave SmartLogger mainly applies to power grid scheduling of large-sized power stations. One SmartLogger can connect to a maximum of 80 devices. When there are more than 80 inverters in the power station, a certain number of Slave SmartLoggers should be configured. The power grid scheduling command sent to the Master SmartLogger is synchronized to the Slave SmartLogger to enable the centralized power grid scheduling of the power station.

Devices can only be manually added and removed in the Slave SmartLogger on the monitoring panel or the embedded WebUI.



NOTICE

The Slave SmartLogger and the Master SmartLogger should be within the same local area network (LAN).

Procedure

- To query Slave SmartLogger information, perform the steps described in the following table. The parameter values in the figures are for reference only.

| LCD | Procedure |
|-----|---|
| | <p>1. On the default page, press to enter the main menu.</p> |
| | <p>2. Select and press .</p> |

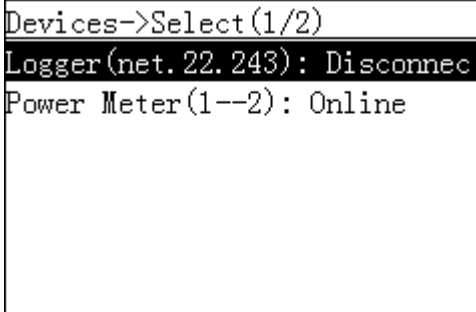
| LCD | Procedure |
|---|---|
|  | <p>3. Choose Logger to view the status and IP address of the Slave SmartLogger.</p> <p>The status of the Slave SmartLogger can either Online or Disconnection.</p> |





----End

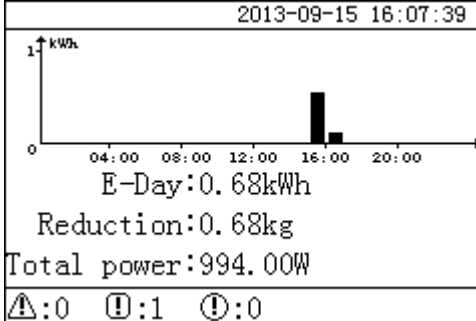

6.2.7 Querying Power Meter Information

This topic describes how to query the power meter information on the monitoring panel.

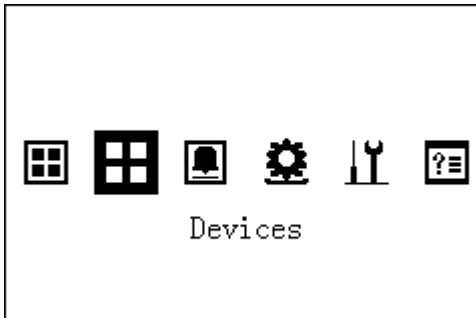
Procedure

- To query the power meter information, perform the steps described in the following table. The parameter values in the figures are for reference only.

| LCD | Operation Procedure |
|---|---|
|  | <p>1. On the default page, press  to enter the main menu.</p> |
|  | <p>2. Select  and press .</p> |

| LCD | Operation Procedure |
|---|---|
| <pre> Devices->Select(4/5) Logger(Local) Logger(net.0.11): Disconnecti SUN8000(3--2): Disconnection Power Meter(2--2): Disconnect AC Combiner(3--1): Disconnect </pre> | <p>3. Choose Power Meter and press  to query the power meter information.</p> <p>NOTE Power Meter (2--2) on the left indicates that the power meter connects to Port 2 of the SmartLogger and the communications address of the RS485 port is 2.</p> <p>The status of the power meter can be neither Online or Disconnection.</p> |
| <pre> Power Meter(2--2) Running </pre> | <p>4. Select Running and press .</p> <ul style="list-style-type: none"> To view the analog data of the power meter, perform step 5 only. To view the communications address of the power meter, perform step 6 only. |
| <pre> Power Meter(2--2) Analog Data Comm. Address </pre> <p style="text-align: center;">↓</p> <pre> Power Meter(1--2) A-B line voltage:387.00V B-C line voltage:387.20V C-A line voltage:386.80V Phase A current:23.0A Phase B current:23.0A Phase C current:23.0A Active power:15.000kW </pre> | <p>5. Select Analog Data, and press .</p> |

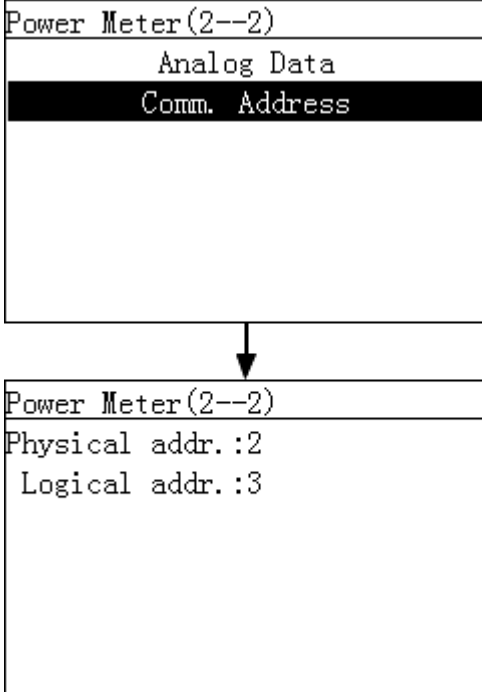
| LCD | Operation Procedure |
|---|---|
|  | <p>6. Select Comm. Address, and press ↵.</p> |

----End







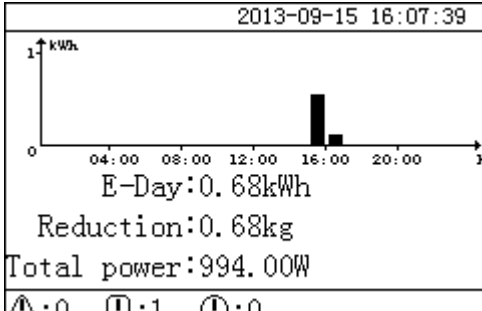

6.2.8 Querying AC Combiner Box Information

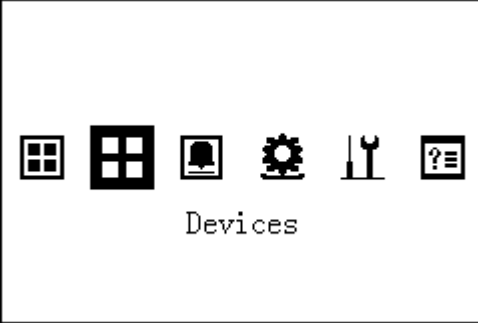
This topic describes how to query the running information and version of an AC combiner box connected to the SmartLogger.

Procedure

- The following table describes the procedure for viewing the information about an AC combiner box. The parameter values in the figures are for reference only.

| LCD | Operation Procedure |
|---|--|
|  | <p>1. On the default page, press ↵ to enter the main menu.</p> |

| LCD | Operation Procedure |
|--|--|
|  | <p>2. Select  and press .</p> |
| <pre> Devices->Select(5/5) Logger(Local) Logger(net.0.11): Disconnect SUN8000(3--2): Disconnection Power Meter(2--2): Disconnect AC Combiner(3--1): Disconnect </pre> | <p>3. Select an AC combiner box and press .</p> <p>NOTE AC Combiner (3--1) in the left figure indicates that the AC combiner box is connected to the Port 3 of the SmartLogger, and its RS485 communications address is 1.</p> <p>The states of the AC combiner box can be Online and Disconnection.</p> <p>The subsequent operations are as follows:</p> <ul style="list-style-type: none"> To view the operating data of the AC combiner box, perform step 4 only. To view the version information of the AC combiner box, perform step 5 only. |
| <pre> AC Combiner(3--1) Running Settings About </pre> <p style="text-align: center;">↓</p> <pre> AC Combiner(3--1) Analog Data Binary Data Comm. Address </pre> | <p>4. Select Running and press .</p> <p>Press  and  to select the target parameter, and then press .</p> |

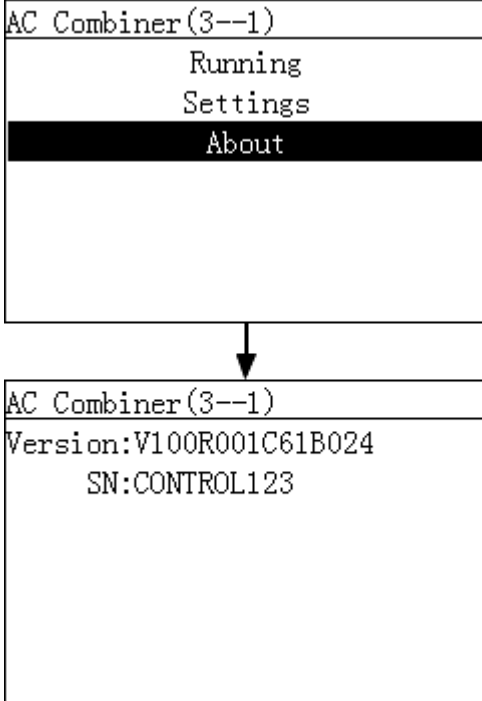
| LCD | Operation Procedure |
|---|--|
|  <p>AC Combiner(3--1) Running Settings About</p> <p>↓</p> <p>AC Combiner(3--1) Version:V100R001C61B024 SN:CONTROL123</p> | <p>5. Select About and press ↵.</p> |

----End





6.2.9 Setting Feature Parameters for an AC Combiner Box

This topic describes how to set feature parameters for an AC combiner box on the monitoring panel.

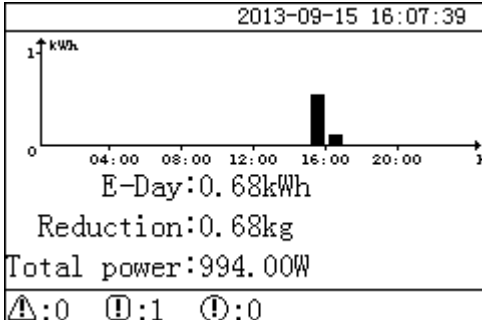
Procedure

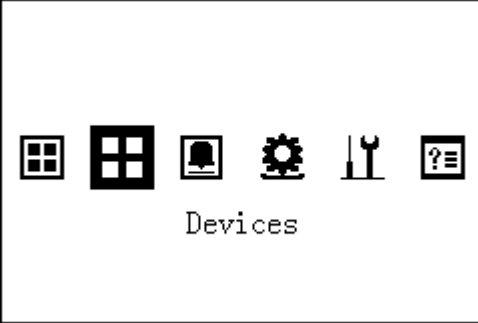
- The following table describes the procedure for setting feature parameters for an AC combiner box. The parameter values in the figures are for reference only.

| LCD | Operation Procedure |
|--|--|
|  <p>2013-09-15 16:07:39</p> <p>↑ kWh</p> <p>04:00 08:00 12:00 16:00 20:00 h</p> <p>E-Day:0.68kWh Reduction:0.68kg Total power:994.00W ⚠:0 📶:1 📶:0</p> | <p>1. On the default page, press ↵ to enter the main menu.</p> |

| LCD | Operation Procedure |
|---|---|
|  | <p>2. Select  and press .</p> |
| <pre>Devices->Select(5/5) Logger(Local) Logger(net.0.11): Disconnecti SUN8000(3--2): Disconnection Power Meter(2--2): Disconnect AC Combiner(3--1): Disconnect</pre> | <p>3. Select an AC combiner box and press .</p> <p>NOTE AC Combiner (3--1) in the left figure indicates that the AC combiner box is connected to the Port 3 of the SmartLogger, and its RS485 communications address is 1.</p> |
| <pre>AC Combiner(3--1) Running Settings About</pre> | <p>4. Select Settings and press .</p> |
| <pre>Settings->Login User Name:Advanced User Password:000000</pre> | <p>5. Set User Name and Password.</p> <p>NOTE Because of the limited permission, select User Name as Advanced User. The initial password for Advanced User is 000001.</p> |

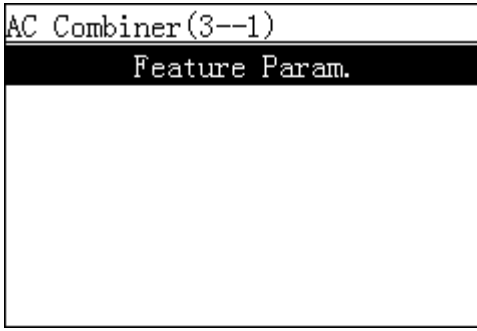
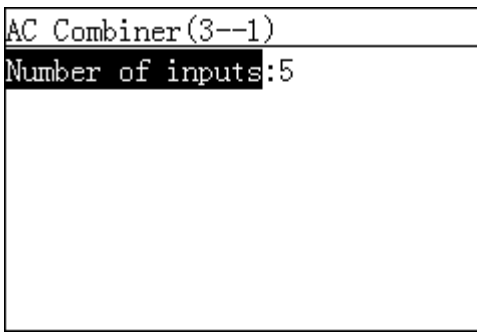
| LCD | Operation Procedure |
|---|--|
|  | <p>6. Select Feature Param. and press ↵.</p> |
|  | <p>7. Set Number of inputs based on the AC combiner box connection.</p> |

----End





6.2.10 Querying PLC Information

This section describes how to query the running information and version of a PLC connected to the SmartLogger.

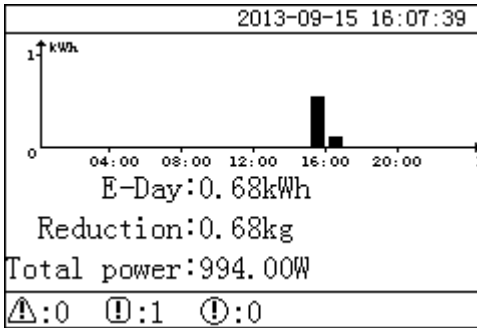
Procedure

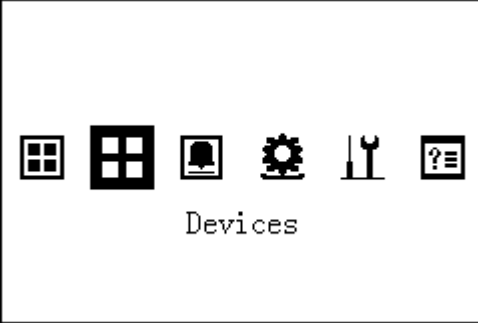
- The following table describes the procedure for viewing the information about a PLC. The parameter values in the figures are for reference only.

| LCD | Operation Procedure |
|---|--|
|  | <p>1. On the default page, press ↵ to enter the main menu.</p> |

| LCD | Operation Procedure |
|--|---|
|  | <p>2. Select  and press .</p> |
| <pre> Devices->Select (3/5) Logger (Local) :Online SUN2000 (3-1) :Loading PLC (3-249) :Online PID (3-2) :Running EMI (3-5) :Online </pre> | <p>3. Select a PLC and press .</p> <p>NOTE PLC (3-249) in the left figure indicates that the PLC is connected to the Port 3 of the SmartLogger, and its RS485 communications address is 249.</p> <p>The states of the PLC can be Online and Disconnection.</p> <p>The subsequent operations are as follows:</p> <ul style="list-style-type: none"> • To view the operating data of the AC combiner box, perform step 4 to 5. • To view the version information of the AC combiner box, perform step 6 only. |
| <pre> PLC (3-249) Running Settings About </pre> | <p>4. Select Running and press .</p> |

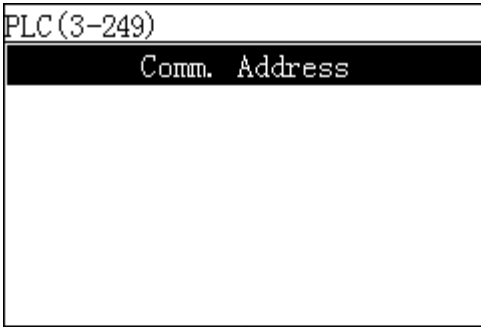
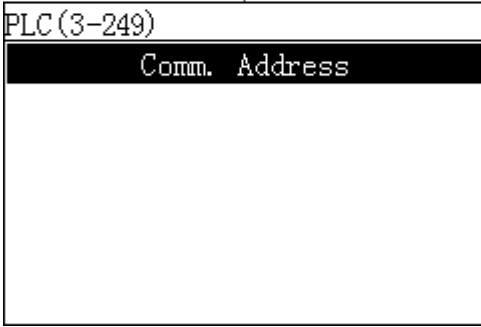
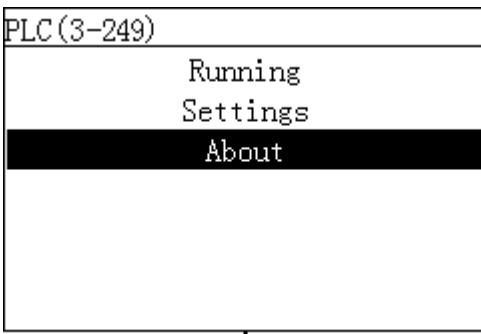
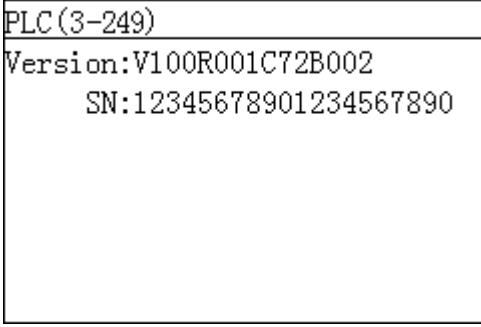
| LCD | Operation Procedure |
|--|---|
|  <p>PLC(3-249)</p> <p>Comm. Address</p> <p>↓</p>  <p>PLC(3-249)</p> <p>Comm. Address</p> | <p>5. Select Comm. Address, and then press ↵</p> |
|  <p>PLC(3-249)</p> <p>Running</p> <p>Settings</p> <p>About</p> <p>↓</p>  <p>PLC(3-249)</p> <p>Version:V100R001C72B002</p> <p>SN:12345678901234567890</p> | <p>6. Select About and press ↵</p> |









----End

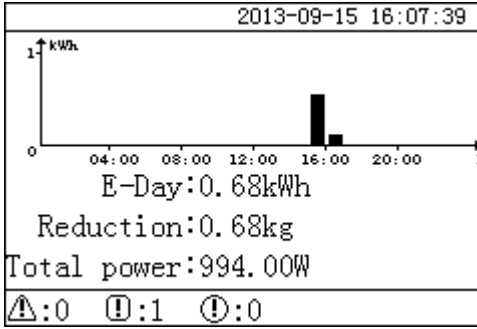

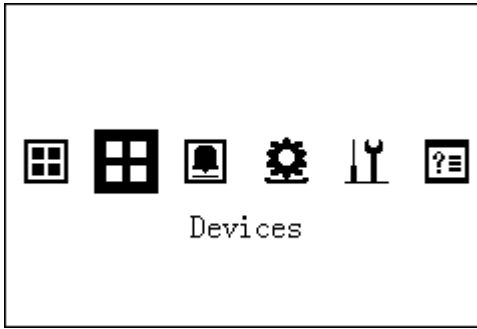

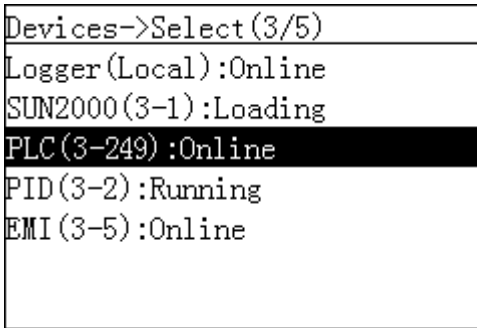
6.2.11 Sending a Reset Command to the PLC

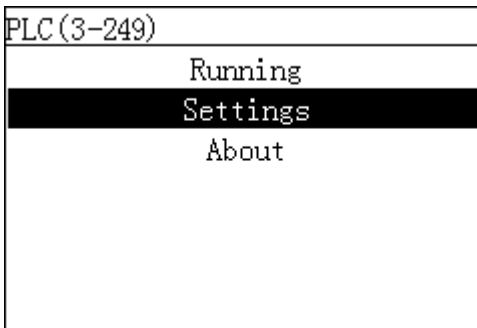
You can send a reset command to the PLC on the monitoring panel.

Procedure

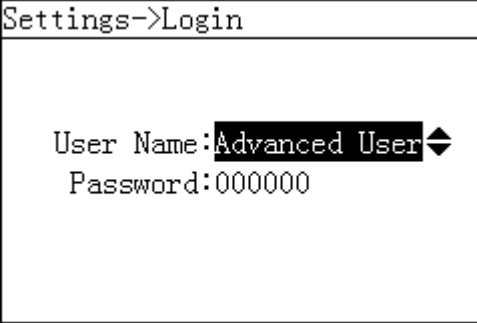
- The following table describes the steps for sending a reset command to the PLC. The parameter values in the following figures are for reference only.

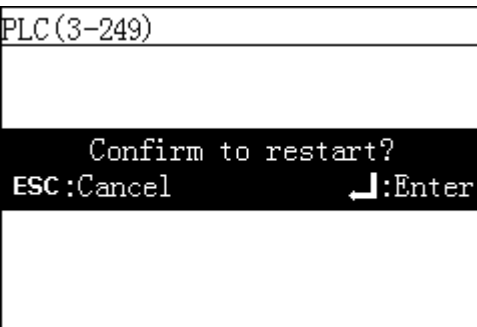
| LCD | Operation Procedure |
|---|--|
|  <p>2013-09-15 16:07:39</p> <p>1↑ kWh</p> <p>04:00 08:00 12:00 16:00 20:00 h</p> <p>E-Day:0.68kWh Reduction:0.68kg Total power:994.00W A:0 I:1 O:0</p> | <p>1. On the default page, press  to enter the main menu.</p> |
|  <p>Devices</p> | <p>2. Choose  and press .</p> |
|  <p>Devices->Select (3/5)</p> <p>Logger(Local):Online SUN2000(3-1):Loading PLC(3-249):Online PID(3-2):Running EMI(3-5):Online</p> | <p>3. Select a PLC and press .</p> <p>NOTE PLC (3-249) in the left figure indicates that the PLC is connected to the Port 3 of the SmartLogger, and its RS485 communications address is 249.</p> |
|  <p>PLC(3-249)</p> <p>Running Settings About</p> | <p>4. Select Settings and press .</p> |

| LCD | Operation Procedure |
|--|--|
|  | <p>5. Set User Name and Password.</p> <p>NOTE Because of the limited permission, select User Name as Advanced User. The initial password for Advanced User is <i>000001</i>.</p> |
|  | <p>6. Choose Restart, and press .</p> |
|  | <p>7. Press  to verify your settings.</p> |

----End







6.2.12 Querying PID Information

This topic describes how to query the running information and version of a PID connected to the SmartLogger.

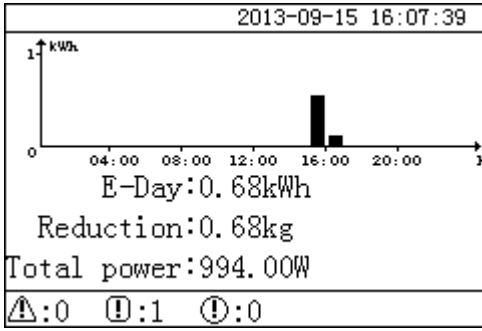
Procedure

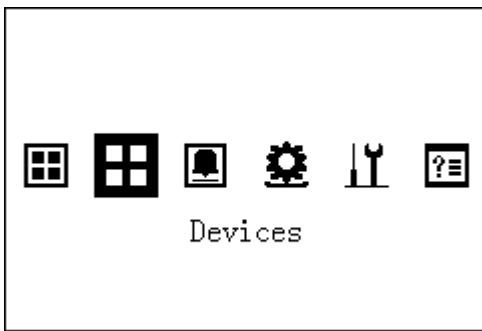
- The following table describes the procedure for viewing the information about a PID. The parameter values in the figures are for reference only.

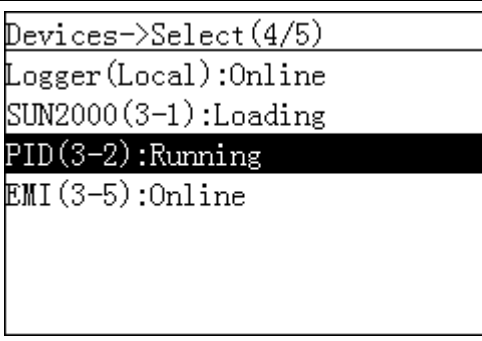
| LCD | Operation Procedure |
|-----|---------------------|
|-----|---------------------|

| LCD | Operation Procedure |
|--|--|
|  | <p>1. On the default page, press  to enter the main menu.</p> |
|  | <p>2. Select  and press .</p> |
|  | <p>3. Select a PID combiner box and press .</p> <p>NOTE PID (3--2) in the left figure indicates that the PID is connected to the Port 3 of the SmartLogger, and its RS485 communications address is 2.</p> <p>The subsequent operations are as follows:</p> <ul style="list-style-type: none"> • To view the operating data of the PID, perform step 4 only. • To view the version information of the PID, perform step 5 only. |

| LCD | Operation Procedure |
|--|---|
| <div style="border: 1px solid black; padding: 5px; margin-bottom: 10px;"> PID(3-2) <div style="background-color: black; color: white; text-align: center; padding: 2px;">Running</div> Settings About </div> <div style="text-align: center; margin: 5px 0;">↓</div> <div style="border: 1px solid black; padding: 5px;"> PID(3-2) <div style="background-color: black; color: white; text-align: center; padding: 2px;">Analog Data</div> Comm. Address </div> | 4. Select Running and press ↵. Press ▲ and ▼ to select Analog Data or Comm. Address , and then press ↵. |
| <div style="border: 1px solid black; padding: 5px; margin-bottom: 10px;"> PID(3-2) Running Settings <div style="background-color: black; color: white; text-align: center; padding: 2px;">About</div> </div> <div style="text-align: center; margin: 5px 0;">↓</div> <div style="border: 1px solid black; padding: 5px;"> PID(3-2) Version:V200R1001C00 SN:021TNR74810000000002 </div> | 5. Select About and press ↵. |







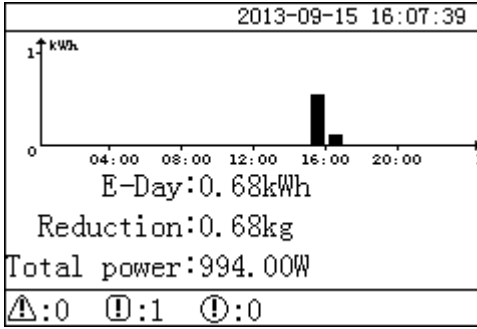

----End

6.2.13 Setting Feature Parameters for a PID

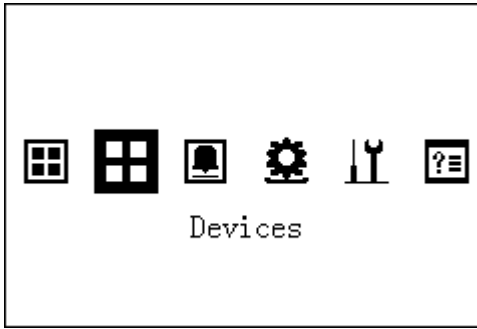
You can set feature parameters for a PID on the monitoring panel.

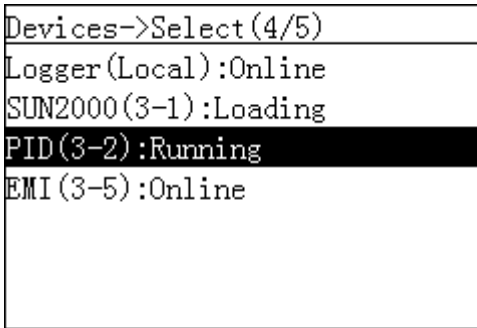
Procedure

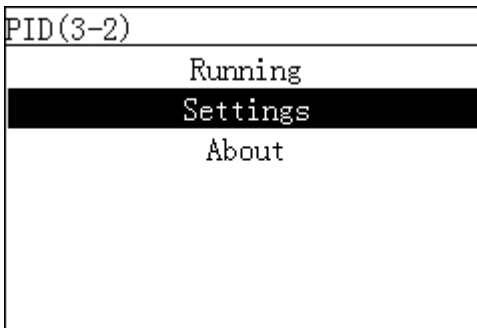
- The following table describes the procedure for setting feature parameters for a PID. The parameter values in the figures are for reference only.

| LCD | Operation Procedure |
|---|---|
|  | <p>1. On the default page, press  to enter the main menu.</p> |
|  | <p>2. Select  and press .</p> |
|  | <p>3. Select a PID combiner box and press .</p> <p>NOTE PID (3--2) in the left figure indicates that the PID is connected to the Port 3 of the SmartLogger, and its RS485 communications address is 2.</p> |
|  | <p>4. Select Settings and press .</p> |

| LCD | Operation Procedure |
|---|--|
| <pre>Settings->Login User Name:Advanced User Password:000000</pre> | <p>5. Set User Name and Password.</p> <p>NOTE Because of the limited permission, select User Name as Advanced User. The initial password for Advanced User is <i>000001</i>.</p> |
| <pre>PID(3-2) Feature Param. Power-On/Off</pre> | <p>6. Select Feature Param. and press ↵.</p> |
| <pre>PID(3-2) Control mode:Disabled Output enabled:Disable PV type:P-type Volt. Inject. into PV:0.0V Operation mode:Normal Commission out. volt.:0.0V Data Clear:Starting</pre> | <p>7. Set parameters based on site requirements.</p> |

----End









6.2.14 Manually Powering On or Off the PID on the monitoring panel

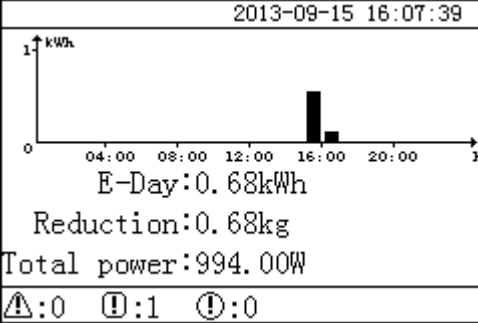

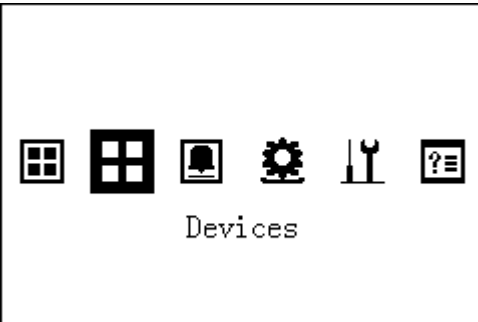

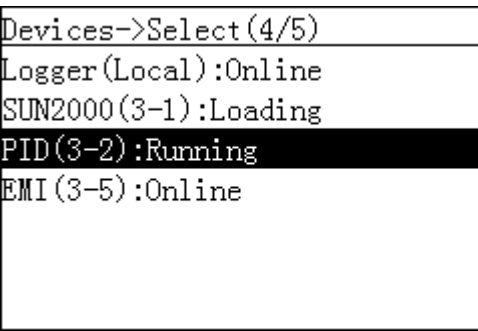
This topic describes how to power on or off the PID on the monitoring panel.

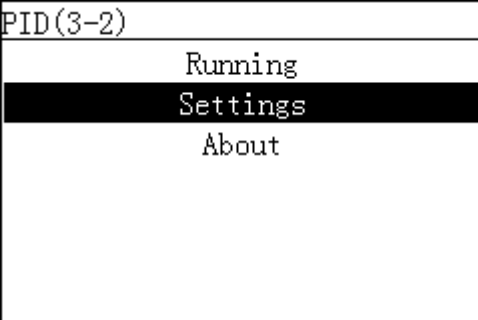
Procedure

- The following table shows the procedure for powering on or off the PID on the monitoring panel. The parameter values in the following figures are for reference only.

| LCD | Operation Procedure |
|-----|---------------------|
|-----|---------------------|

| LCD | Operation Procedure |
|---|--|
|  | <p>1. On the default page, press  to enter the main menu.</p> |
|  | <p>2. Choose  and press .</p> |
|  | <p>3. Select a PID combiner box and press .</p> <p>NOTE PID (3--2) in the left figure indicates that the PID is connected to the Port 3 of the SmartLogger, and its RS485 communications address is 2.</p> |
|  | <p>4. Select Settings and press .</p> |

| LCD | Operation Procedure |
|---|--|
| <p>Settings->Login</p> <p>User Name: Advanced User </p> <p>Password: 000000</p> | <p>5. Set User Name and Password.</p> <p>NOTE Because of the limited permission, select User Name as Advanced User. The initial password for Advanced User is <i>000001</i>.</p> |
| <p>PID(3-2)</p> <p>Feature Param.</p> <p>Power-On/Off</p> | <p>6. Choose Power-On/Off, and press .</p> <ul style="list-style-type: none"> • Perform step 7 if you want to power on the inverter manually. • Perform step 8 if you want to power off the inverter manually. |
| <p>PID(3-2)</p> <p>Power-On</p> <p>Power-Off</p> <p style="text-align: center;">↓</p> <p>PID(3-2)</p> <p>Power on?</p> <p>ESC:Cancel :Enter</p> | <p>7. Power on manually.</p> <p>a. Choose Power-On and press .</p> <p>b. Enter  again to verify your settings.</p> |

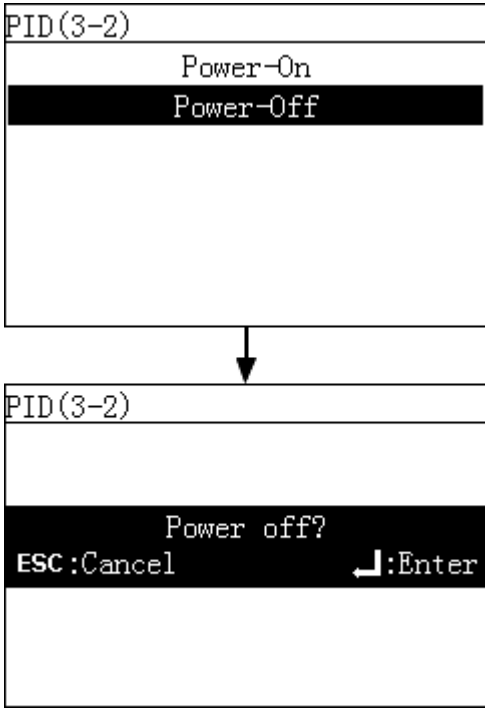
| LCD | Operation Procedure |
|--|--|
|  <p>PID(3-2)</p> <p>Power-On</p> <p>Power-Off</p> <p>↓</p> <p>PID(3-2)</p> <p>Power off?</p> <p>ESC:Cancel ↵:Enter</p> | <p>8. Power off manually.</p> <p>a. Choose Power-Off, and press ↵.</p> <p>b. Enter ↵ again to verify your settings.</p> |

----End





6.2.15 Querying Custom Device Information

This topic describes how to query the running information and version of a custom device connected to the SmartLogger.

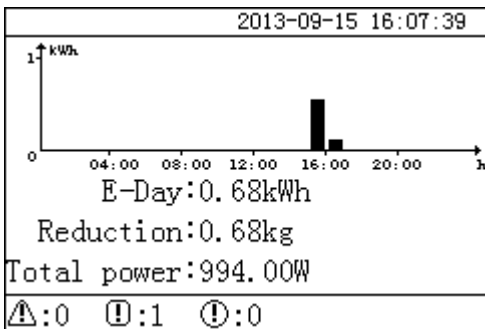
Procedure

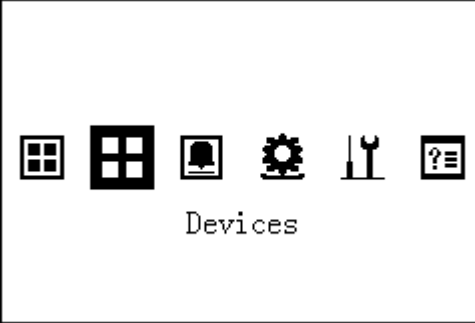
- The following table describes the procedure for viewing the information about a custom device. The parameter values in the figures are for reference only.

| LCD | Operation Procedure |
|---|--|
|  <p>2013-09-15 16:07:39</p> <p>↑ kWh</p> <p>04:00 08:00 12:00 16:00 20:00 h</p> <p>E-Day:0.68kWh</p> <p>Reduction:0.68kg</p> <p>Total power:994.00W</p> <p>⚠:0 ⓘ:1 ⓘ:0</p> | <p>1. On the default page, press ↵ to enter the main menu.</p> |

| LCD | Operation Procedure |
|--|--|
|  | <p>2. Select  and press .</p> |
| <pre> Devices->Select(5/6) Logger(Local):Online SUN2000(3-1):Loading PLC(3-3):Online PID(3-2):Running Custom Device1(3-4):Disconnec EMI(3-5):Online </pre> <p style="text-align: center;">↓</p> <pre> Custom Device1(3-4) Port number:3 Physical addr.:4 Logical addr.:5 </pre> | <p>3. Select a custom device and press .</p> <p>NOTE Custom Device1 (3--4) in the left figure indicates that the custom device is connected to the Port 3 of the SmartLogger, and its RS485 communications address is 4.</p> |

----End

6.2.16 Querying Alarm Records







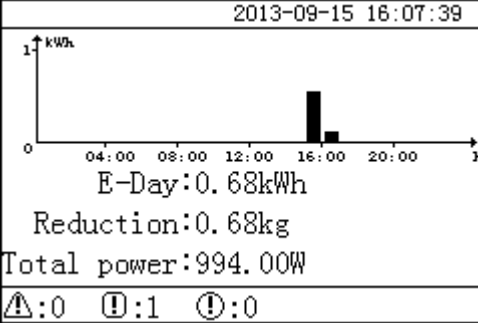

This topic describes how to query active and historical alarms for the SmartLogger and the connected inverters and how to set the alarm record sort mode on the monitoring panel.

Context

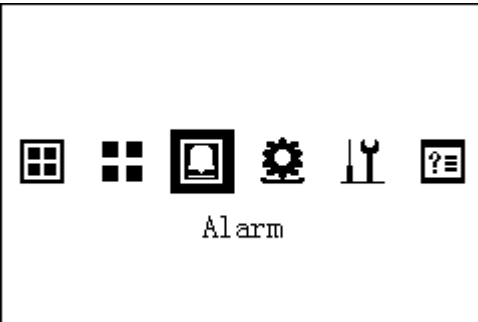
The LCD displays a maximum of 8000 latest alarm records.

Procedure

- The following table describes the procedure for querying active and historical alarms and setting the alarm record sort mode. The parameter values in the figures are for reference only.

| LCD | Operation Procedure | | | | | | |
|--|---|--------|-----|---------|--------|-----|--|
|  | <p>1. On the default page, press  to enter the main menu.</p> | | | | | | |
|  | <p>2. Choose  and press .</p> | | | | | | |
| <p>Alarm</p> <ul style="list-style-type: none"> Active Alarms Alarm History Sort By | <p>3. Press , choose the appropriate menu, and press .</p> <ul style="list-style-type: none"> • Perform step 4 and step 5 to view active alarms. • Perform step 6 and step 7 to view historical alarms. • Perform step 8 to set the alarm sort mode. | | | | | | |
| <p>Active Alarms->Select(1/2)</p> <table border="1" data-bbox="395 1379 874 1458"> <tr> <td>SUN2000</td> <td>(1--7)</td> <td>(1)</td> </tr> <tr> <td>SUN8000</td> <td>(1--8)</td> <td>(0)</td> </tr> </table> | SUN2000 | (1--7) | (1) | SUN8000 | (1--8) | (0) | <p>4. On the Active Alarms screen, select the target device name and press  to view all the active alarms for this device.</p> |
| SUN2000 | (1--7) | (1) | | | | | |
| SUN8000 | (1--8) | (0) | | | | | |

| LCD | Operation Procedure |
|--|--|
| <div style="border: 1px solid black; padding: 5px;"> <p>Active Alarms(1/1)</p> <p>ⓘVersion Mismatch/ID:1</p> </div> <p style="text-align: center;">↓</p> <div style="border: 1px solid black; padding: 5px;"> <p>Version Mismatch(1/1)</p> <p>Alarm ID:504</p> <p>Severity:Minor ⓘ</p> <p>Generated:2013-08-13 11:26:18</p> <p>Info:</p> <p>Reason ID = 1</p> </div> | <p>5. Select one of the alarm records by pressing ▲ or ▼, and view the alarm details by pressing ↵.</p> <p>The alarm details include the Alarm ID, Severity, Generated, Info, and Reason ID.</p> <p>NOTE</p> <ul style="list-style-type: none"> • For details about the alarm list of the SUN2000, see 9.3 Alarms. • For details about the alarm list of the SUN2000, see the Common Faults and Troubleshooting Measures in the <i>SUN2000 (8KTL-28KTL) User Manual</i>. • For details about the alarm list of the SUN8000, see the Common Faults and Troubleshooting Measures in the <i>SUN8000-500KTL User Manual</i>. |
| <div style="border: 1px solid black; padding: 5px;"> <p>Alarm History->Select(1/2)</p> <p>SUN2000 (1--7) (7)</p> <p>SUN8000 (1--8) (9)</p> </div> | <p>6. On the Alarm History screen, select the target device name and press ↵ to view all the historical alarms for this device.</p> |

| LCD | Operation Procedure |
|---|--|
| <div style="border: 1px solid black; padding: 5px;"> <p>Alarm History(1/4)</p> <p>⚠Grid Volt. Abnormal/ID:29</p> <p>⚠Grid Volt. Abnormal/ID:29</p> <p>⚠Grid Volt. Abnormal/ID:29</p> <p>①Version Mismatch/ID:1</p> </div> <p style="text-align: center;">↓</p> <div style="border: 1px solid black; padding: 5px;"> <p>Grid Volt. Abnormal(1/4)</p> <p>Alarm ID:301</p> <p>Severity:Major ⚠</p> <p>Generated:2013-08-13 11:24:27</p> <p> Cleared:2013-08-13 11:26:45</p> <p> Info:</p> <p> Reason ID = 29</p> </div> | <p>7. Select one of the historical alarms by pressing ▲ or ▼ and view the alarm details by pressing ↵.</p> <p>The alarm details include the Alarm ID, Severity, Generated, Cleared, Info, and Reason ID.</p> <p>NOTE</p> <ul style="list-style-type: none"> • For details about the alarm list of the SUN2000, see 9.3 Alarms. • For details about the alarm list of the SUN2000, see the Common Faults and Troubleshooting Measures in the <i>SUN2000 (8KTL-28KTL) User Manual</i>. • For details about the alarm list of the SUN8000, see the Common Faults and Troubleshooting Measures in the <i>SUN8000-500KTL User Manual</i>. |
| <div style="border: 1px solid black; padding: 5px;"> <p>Alarm</p> <p>Active Alarms</p> <p>Alarm History</p> <p>Sort By</p> </div> <p style="text-align: center;">↓</p> <div style="border: 1px solid black; padding: 5px;"> <p>Alarm</p> <p>Sort By</p> <p>Generation time ✓</p> <p>Alarm severity</p> </div> | <p>8. On the Sort By screen, select Generation time or Alarm severity.</p> |









----End

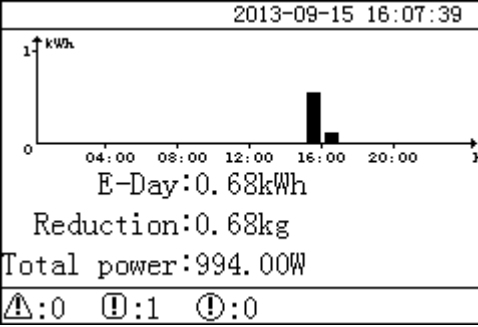

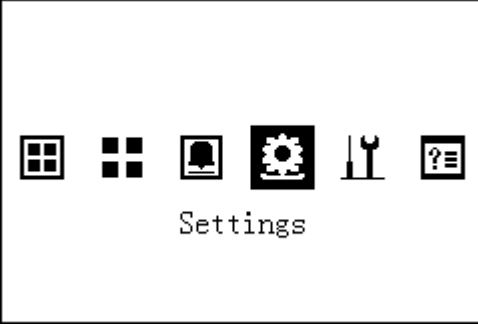

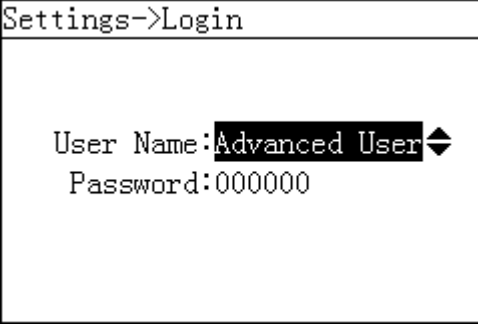

6.2.17 Setting the System Language

This topic describes how to set the display language for the SmartLogger on the monitoring panel.

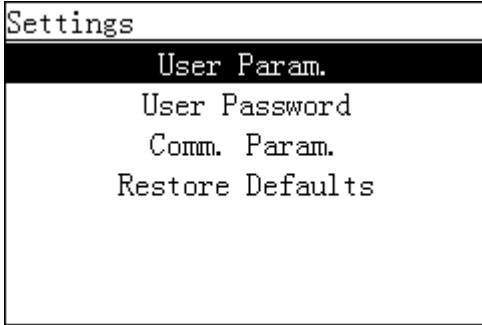
Procedure

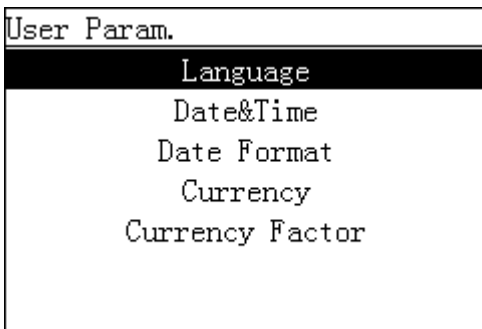
- The following table describes the procedure for setting the display language. The parameter values in the following figures are for reference only.

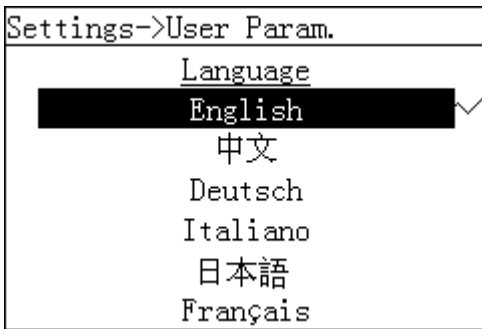
| LCD | Operation Procedure |
|---|---|
|  | <p>1. On the default page, press  to enter the main menu.</p> |
|  | <p>2. Choose  and press .</p> |
|  | <p>3. Specify the User Name and Password by pressing  or , and then press .</p> <p>NOTE</p> <ul style="list-style-type: none"> Because of the limited permission, select the User Name as Common User or Advanced User. The initial password for Common User and Advanced User is <i>000001</i>. After passing the permission validation, the system keeps the authentication information for 30 seconds. If you exit from the Settings page and log in again within 30 seconds, no authentication is required. |

| LCD | Operation Procedure |
|---|---|
|  <p>Settings</p> <p>User Param.</p> <p>User Password</p> <p>Comm. Param.</p> <p>Restore Defaults</p> <p>Here use the pages displayed when you log in to the SmartLogger as Advanced User.</p> | <p>4. Choose User Param., and press .</p> |
|  <p>User Param.</p> <p>Language</p> <p>Date&Time</p> <p>Date Format</p> <p>Currency</p> <p>Currency Factor</p> | <p>5. Choose Language, and press .</p> |
|  <p>Settings->User Param.</p> <p>Language</p> <p>English</p> <p>中文</p> <p>Deutsch</p> <p>Italiano</p> <p>日本語</p> <p>Français</p> | <p>6. On the Language page, select a display language, and press .</p> <p>The pages will be displayed in the selected language.</p> |

----End









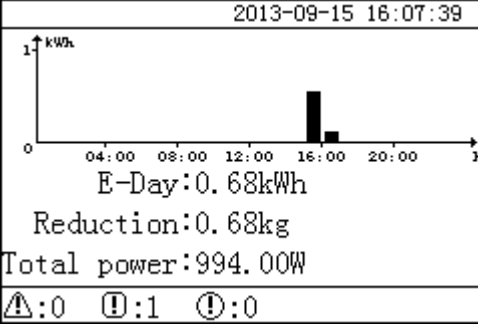

6.2.18 Setting System Time Parameters

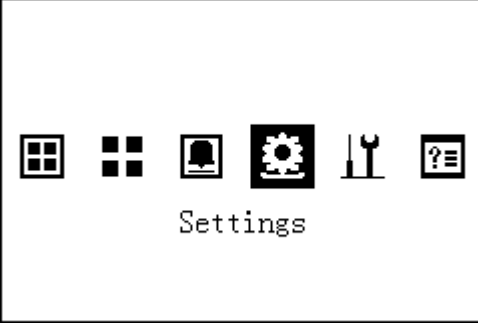
This topic describes how to set the date, time and date format for the SmartLogger on the monitoring panel.

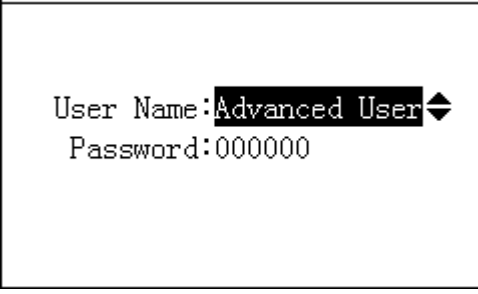
Procedure

- The following table describes the procedure for setting the time and date. The parameter values in the following figures are for reference only.

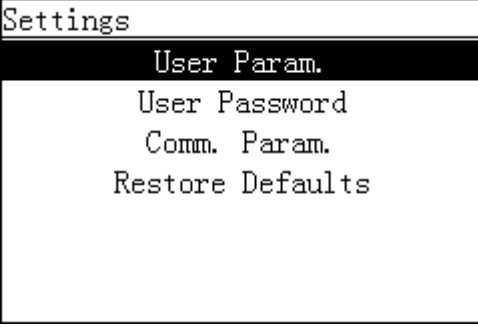
| LCD | Operation Procedure |
|-----|---------------------|
|-----|---------------------|

| LCD | Operation Procedure |
|---|--|
|  | <p>1. On the default page, press  to enter the main menu.</p> |
|  | <p>2. Choose  and press .</p> |
| <p>Settings->Login</p>  | <p>3. Specify the User Name and Password by pressing  or , and then press .</p> <p>NOTE</p> <ul style="list-style-type: none"> Because of the limited permission, select the User Name as Common User or Advanced User. The initial password for Common User and Advanced User is <i>000001</i>. After passing the permission validation, the system keeps the authentication information for 30 seconds. If you exit from the Settings page and log in again within 30 seconds, no authentication is required. |
| <p>Settings</p>  <p>Here use the pages displayed when you log in to the SmartLogger as Advanced User.</p> | <p>4. Choose User Param., and press .</p> |

| LCD | Operation Procedure |
|--|--|
| <div style="border: 1px solid black; padding: 5px;"> <p>User Param.</p> <p style="text-align: center;">Language</p> <p style="text-align: center;">Date&Time</p> <p style="text-align: center;">Date Format</p> <p style="text-align: center;">Currency</p> <p style="text-align: center;">Currency Factor</p> </div> <div style="border: 1px solid black; padding: 5px; margin-top: 5px;"> <p>User Param.</p> <p style="text-align: center;">Language</p> <p style="text-align: center;">Date&Time</p> <p style="text-align: center;">Date Format</p> <p style="text-align: center;">Contrast</p> <p style="text-align: center;">Currency</p> <p style="text-align: center;">Currency Factor</p> </div> | <p>5. Choose Date&Time or Date Format by pressing ▼, and press ↵.</p> <p>NOTICE</p> <ul style="list-style-type: none"> • Modifying Date&Time will affect the integrity of the SmartLogger's energy yield and performance data. Hence, do not change it at will. • After Date&Time is successfully set, this time can be synchronized in all the inverters connected to the SmartLogger. |
| <div style="border: 1px solid black; padding: 5px;"> <p>Settings->User Param.</p> <p style="text-align: center;">Date&Time</p> <p>Time Zone:UTCDublin</p> <p style="text-align: center;">DST:Disable</p> <p style="text-align: center;">Date:2013-06-30</p> <p style="text-align: center;">Time:12:09:52</p> </div> | <p>6. On the Date&Time page, set the date and time, set the time zone, enable or disable the daylight saving time, and press ↵.</p> <ul style="list-style-type: none"> • To select the specific parameter, click ↵. To set the parameter value, set ▲ or ▼. • Set Time Zone based on the location of the inverters and enable or disable DST as required. |
| <div style="border: 1px solid black; padding: 5px;"> <p>Settings->User Param.</p> <p style="text-align: center;">Date Format</p> <p style="text-align: center;">YYYY-MM-DD</p> <p style="text-align: center;">MM-DD-YYYY</p> <p style="text-align: center;">DD-MM-YYYY</p> </div> | <p>7. On the Date Format page, select a date format, and press ↵.</p> |

----End

6.2.19 Setting SmartLogger Contrast

You can set the SmartLogger contrast on the monitoring panel.

Context





NOTE

In addition to the method provided in this section, you can also press and hold ▲ or ▼ on the home screen to adjust the contrast.

Procedure

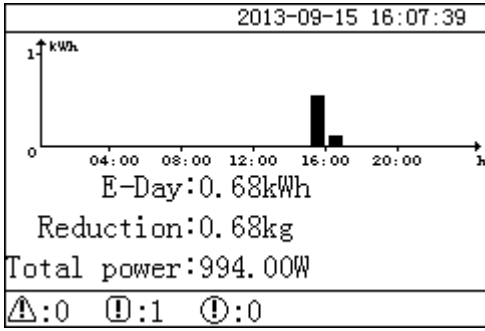
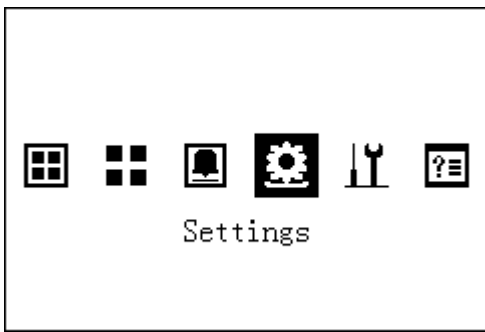
- To set the SmartLogger contrast, perform the steps in the following table: The parameter values in the figures are for reference only.

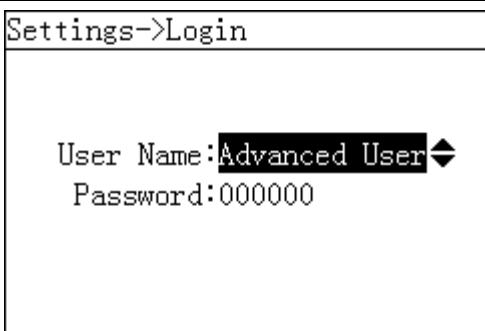
| LCD | Procedure |
|---|---|
|  | <p>1. On the default page, press ↵ to enter the main menu.</p> |
|  | <p>2. Choose  and press ↵.</p> |
|  | <p>3. Specify the User Name and Password by pressing ▲ or ▼, and then press ↵.</p> <p>NOTE</p> <ul style="list-style-type: none"> Because of the limited permission, select the User Name as Common User or Advanced User. The initial password for Common User and Advanced User is <i>000001</i>. After passing the permission validation, the system keeps the authentication information for 30 seconds. If you exit from the Settings page and log in again within 30 seconds, no authentication is required. |

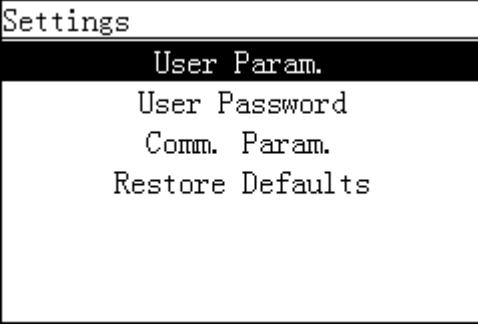
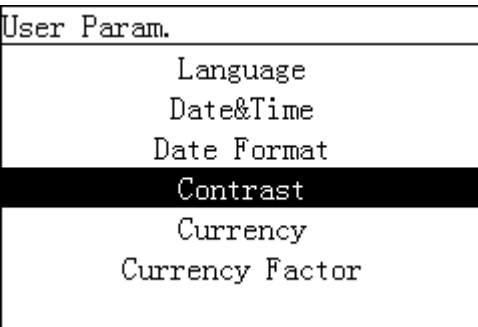
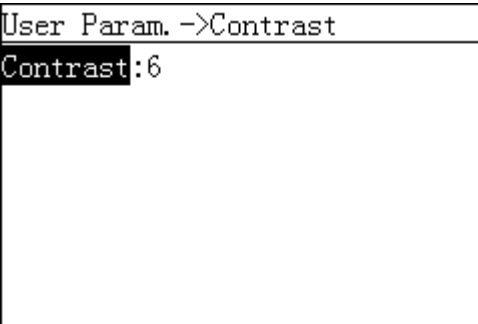
| LCD | Procedure |
|---|--|
|  <p>Settings User Param. User Password Comm. Param. Restore Defaults</p> <p>Here use the pages displayed when you log in to the SmartLogger as Advanced User.</p> | <p>4. Choose User Param., and press ↵.</p> |
|  <p>User Param. Language Date&Time Date Format Contrast Currency Currency Factor</p> | <p>5. Select Contrast and press ↵.</p> |
|  <p>User Param. -> Contrast Contrast:6</p> | <p>6. On the Contrast tab, press ▲ and ▼ to set the contrast.</p> <p>NOTE The contrast value ranges from one to ten.</p> |

----End









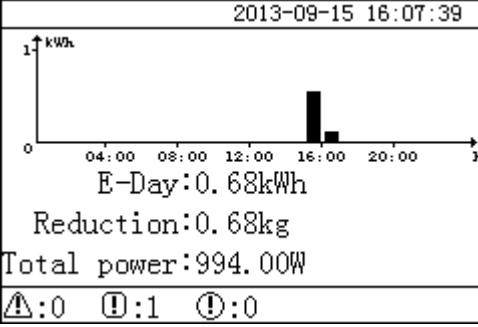

6.2.20 Setting the Currency and Currency Factor

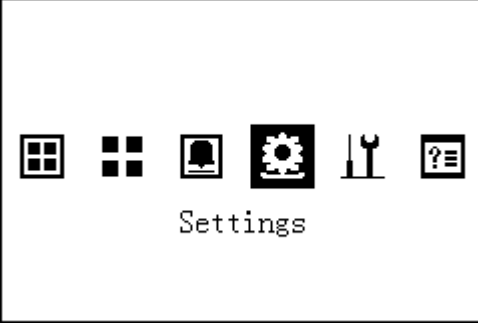
This topic describes how to set the currency and currency factor for the SmartLogger.

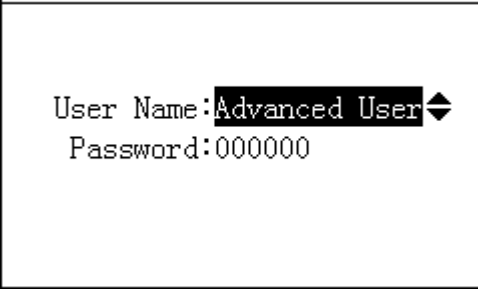
Procedure

- The following table describes the procedure for setting the currency and currency factor. The parameter values in the following figures are for reference only.

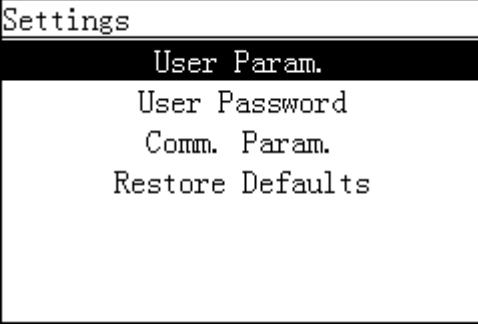
| LCD | Operation Procedure |
|-----|---------------------|
|-----|---------------------|

| LCD | Operation Procedure |
|---|---|
|  | <p>1. On the default page, press  to enter the main menu.</p> |
|  | <p>2. Choose  and press .</p> |
| <p>Settings->Login</p>  | <p>3. Specify the User Name and Password by pressing  or , and then press .</p> <p>NOTE</p> <ul style="list-style-type: none"> Because of the limited permission, select the User Name as Common User or Advanced User. The initial password for Common User and Advanced User is <i>000001</i>. After passing the permission validation, the system keeps the authentication information for 30 seconds. If you exit from the Settings page and log in again within 30 seconds, no authentication is required. |
| <p>Settings</p>  <p>Here use the pages displayed when you log in to the SmartLogger as Advanced User.</p> | <p>4. Choose User Param., and press .</p> <ul style="list-style-type: none"> Perform step 5 to set the currency. Perform step 6 to set the currency factor. |

| LCD | Operation Procedure |
|---|--|
| <div style="border: 1px solid black; padding: 5px; margin-bottom: 5px;"> User Param. Language Date&Time Date Format Currency Currency Factor </div> <div style="text-align: center; margin: 5px 0;">↓</div> <div style="border: 1px solid black; padding: 5px;"> Settings->User Param. Currency EUR GBP USD CNY </div> | <p>5. Set the currency.</p> <p>a. Select Currency by pressing ▼, and press ↵.</p> <p>b. Select a currency, and press ↵.</p> |
| <div style="border: 1px solid black; padding: 5px; margin-bottom: 5px;"> User Param. Language Date&Time Date Format Currency Currency Factor </div> <div style="text-align: center; margin: 5px 0;">↓</div> <div style="border: 1px solid black; padding: 5px;"> Settings->User Param. <u>Currency Factor</u> 0 0 0. 2 5 0 </div> | <p>6. Set the currency factor.</p> <p>NOTICE Set the currency before you set the currency factor. The currency factor is the electricity price per kWh, which is used to calculate the energy yield revenue.</p> <p>a. Select Currency Factor by pressing ▼, and then press ↵.</p> <p>b. Set the currency factor by pressing ▲ or ▼, and then press ↵.</p> |

----End

6.2.21 Changing a Password

This topic describes how to change a password on the monitoring panel.

Context









- The initial password is 000001 for **Common User**, **Advanced User**, and **Special User**.
- After the first login, it is recommended that you change the initial password immediately to ensure account security.
- You are advised to change the password at least once every half year to prevent unauthorized use of your account, which affects system security.

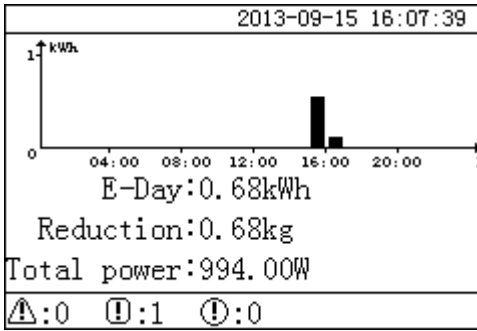

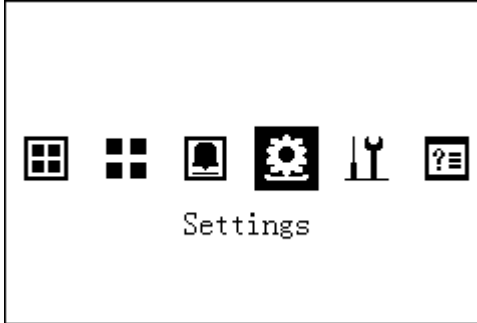
Change the password in compliance with the following principles:

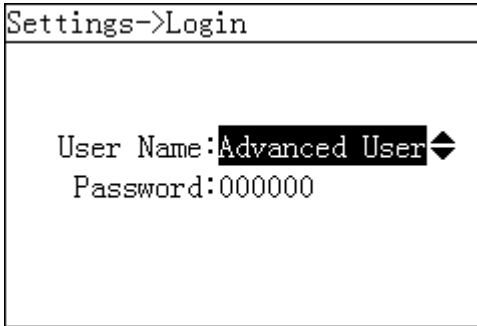
- Six characters are required.
- The password consists of digits, uppercase letters, and lowercase letters.

Procedure

- The following table describes the procedure for changing a password. The parameter values in the figures are for reference only.

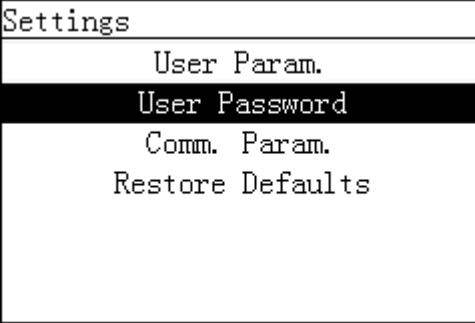
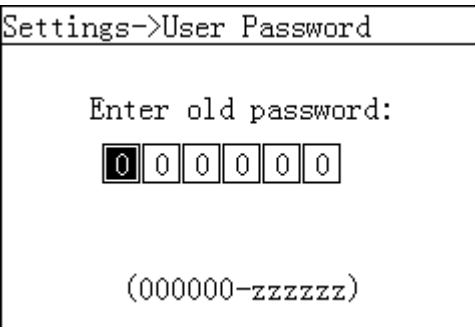
| LCD | Procedure |
|---|--|
|  | <p>1. On the default page, press  to enter the main menu.</p> |
|  | <p>2. Choose  and press .</p> |
|  | <p>3. Set User Name and Password by pressing  or , and press .</p> <p>NOTE</p> <ul style="list-style-type: none"> • User Name can be set to any of the following values: Common User, Advanced User, and Special User. The initial password is 000001. • After the authentication is successful, the system keeps the authentication information for 30 seconds. If you exit from the Settings screen and log in again within 30 seconds, no authentication is required. |

| LCD | Procedure |
|--|---|
|  <p>Settings</p> <p>User Param.</p> <p>User Password</p> <p>Comm. Param.</p> <p>Restore Defaults</p> <p>Here use the pages displayed when you log in to the SmartLogger as Advanced User.</p> | <p>4. Select User Password by pressing ▼, and press ↵.</p> |
|  <p>Settings->User Password</p> <p>Enter old password:</p> <p>0 0 0 0 0 0</p> <p>(000000-zzzzzz)</p> | <p>5. Enter the old password and press ↵. Increase or decrease the value by pressing ▲ or ▼. Switch between data bits by pressing ↵.</p> |
|  <p>Settings->User Password</p> <p>Enter new password:</p> <p>0 0 0 0 0 0</p> <p>(000000-zzzzzz)</p> | <p>6. Enter a new password and press ↵. Increase or decrease the value by pressing ▲ or ▼. Switch between data bits by pressing ↵.</p> |
|  <p>Settings->User Password</p> <p>Confirm new password again:</p> <p>0 0 0 0 0 0</p> <p>(000000-zzzzzz)</p> | <p>7. Enter the new password again and press ↵.</p> <p>NOTE</p> <p>Ensure that you enter the new password twice coherently. Otherwise, an error message is displayed.</p> <p>After the password is changed successfully, the LCD displays operation success information.</p> |

 **NOTE**

If you want to change the password for another account, exit from the **Settings** screen (without logging in to the **Maintenance** screen), wait 30 seconds, log in by using the account for which you want to change the password, and perform step 3 to step 7 in the preceding table.

----End

6.2.22 Setting Communications Parameters





You can set the SmartLogger parameters for communication on the monitoring panel.

Context

- Correctly set RS485 parameters to ensure normal communication between the SmartLogger and the inverters and between the SmartLogger and the environmental monitoring instrument.
- Correctly set Ethernet parameters to ensure proper operation of Ethernet ports and functions of logging in to the embedded WebUI, connecting to the element management system, and sending emails.
- Correctly set NetEco parameters to ensure normal communication between the SmartLogger and the NetEco.

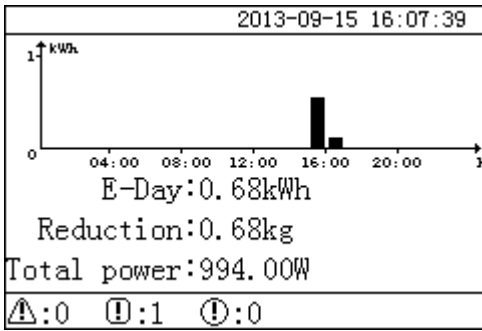
Procedure

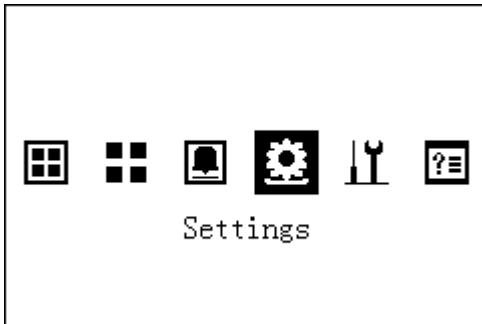
- The following table describes the procedure for setting communications parameters. The parameter values in the following figures are for reference only.

| LCD | Operation Procedure |
|---|---|
|  | <p>1. On the default page, press  to enter the main menu.</p> |
|  | <p>2. Choose  and press .</p> |

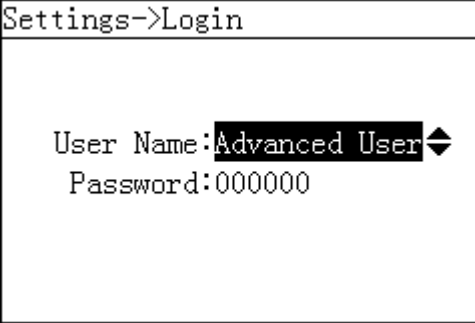
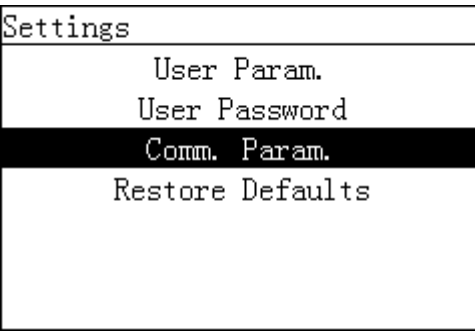
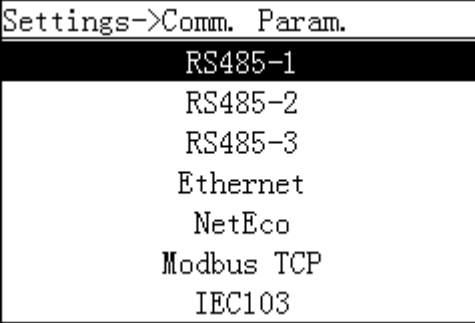
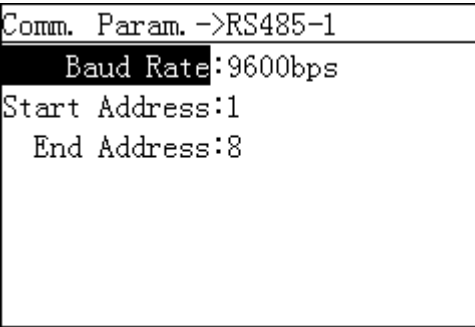
| LCD | Operation Procedure |
|---|---|
|  | <p>3. Set User Name and Password by pressing ▲ or ▼, and press ↵.</p> <p>NOTE</p> <ul style="list-style-type: none"> Set User Name to Advanced User. The initial password for Advanced User is 000001. After passing the permission validation, the system keeps the authentication information for 30 seconds. If you exit from the Settings screen and log in again within 30 seconds, no authentication is required. |
|  <p>Here use the pages displayed when you log in to the SmartLogger as Advanced User.</p> | <p>4. Select Comm. Param. and press ↵.</p> <ul style="list-style-type: none"> Perform step 5 and step 6 to set the parameters for the RS485. Perform step 7 and step 8 to set the parameters for the Ethernet. Perform step 9 and step 10 to set the parameters for the NetEco. Perform step 11 and step 12 to set the parameters for the Modbus TCP. Perform step 13 and step 14 to set the parameters for the IEC103. |
|  | <p>5. Select an RS485 port by pressing ▲ or ▼ and then press ↵.</p> <p>There are three RS485 ports: RS485-1, RS485-2, and RS485-3. The corresponding port for RS485-1 is COM1; RS485-2 is COM2; RS485-3 is COM3.</p> |
|  | <p>6. Set Baud Rate, Start Address and End Address, and press ↵.</p> <ul style="list-style-type: none"> The following baud rates are supported: 4800 bps, 9600 bps, 19200 bps and 115200 bps. 9600 bps is recommended. $1 \leq \text{Start Address} \leq \text{End Address} \leq 247$. The address segments for these three ports can overlap. <p>Set the address scope properly. The broader the scope is, the longer the time is for searching the devices.</p> <ul style="list-style-type: none"> Parity must be set to the same value for all devices connected to the same RS485 port. |

| LCD | Operation Procedure |
|--|--|
| <pre>Settings->Comm. Param. RS485-1 RS485-2 RS485-3 Ethernet NetEco Modbus TCP IEC103</pre> | <p>7. Press ▼, select Ethernet, and press ↵.</p> |
| <pre>Comm. Param. ->Ethernet Auto obtain IP:Disable IP address:192.168. 0. 10 Subnet mask:255.255.255. 0 Gateway:192.168. 0. 1 DNS-1:192.168. 0. 1 DNS-2: 0. 0. 0. 0 Submit</pre> | <p>8. Set Auto obtain IP, IP address, Subnet mask, Gateway, and DNS, and press ↵.</p> <p>NOTE</p> <p>If the SmartLogger connects to the Internet through a router, note the following when setting Ethernet parameters:</p> <ul style="list-style-type: none"> • If you set Auto obtain IP to Enable, the DHCP server on the network assigns IP addresses. In this case, you must ensure that a DHCP server is working on the network. • Set the gateway address to the IP address of the router. • Ensure that the IP address of the SmartLogger is in the same network segment as the gateway address. • Set the domain name server (DNS) address to the IP address of the router or obtain the DNS address from the network provider. |
| <pre>Settings->Comm. Param. RS485-1 RS485-2 RS485-3 Ethernet NetEco Modbus TCP IEC103</pre> | <p>9. Press ▼, select NetEco, and press ↵.</p> |
| <pre>Comm. Param. ->NetEco Address mode:Logical addr. Server IP: 0. 0. 0. 0 Port number:16100</pre> | <p>10. Set Address mode, Server IP, and Port number, and press ↵.</p> <ul style="list-style-type: none"> • In most cases, set Address mode to Physical addr.. If the devices connected to the three RS485 ports of the SmartLogger have duplicate addresses, you must set Address mode to Logical addr. • Set the server IP address correctly. |

| LCD | Operation Procedure |
|---|---|
| <pre>Settings->Comm. Param. RS485-1 RS485-2 RS485-3 Ethernet NetEco Modbus TCP IEC103</pre> | <p>11. Press ▼, select Modbus TCP, and press ↵</p> |
| <pre>Comm. Param. ->Modbus TCP Port enable:Disable Address mode:Physical addr. Client 1 IP: 0. 0. 0. 0 Client 2 IP: 0. 0. 0. 0</pre> | <p>12. Set Port enable, Address mode, Client 1 IP, and Client 2 IP, and press ↵.</p> <ul style="list-style-type: none"> • Modbus-TCP is a general standard protocol without a security authentication mechanism. Therefore, the function of connecting to a third-party NMS using Modbus-TCP is disabled by default to reduce network security risks. Parameters must be set correctly to enable the function. • In most cases, set Address mode to Physical addr.. If the devices connected to the three RS485 ports of the SmartLogger have duplicate addresses, you must set Address mode to Logical addr. • Set the client IP addresses correctly. |
| <pre>Settings->Comm. Param. RS485-1 RS485-2 RS485-3 Ethernet NetEco Modbus TCP IEC103</pre> | <p>13. Press ▼, choose IEC103, and press ↵</p> |
| <pre>Comm. Param. ->IEC103 Port number:No Address:126 IEC103 IP: 0. 0. 0. 0</pre> | <p>14. Set Port number, Address and IEC103 IP, and press ↵.</p> <p>NOTE IEC103 is a general standard protocol without a security authentication mechanism. Therefore, the function of connecting to the NMS using IEC103 is disabled by default to reduce network security risks. Parameters must be set correctly to enable the function.</p> |

----End

6.2.23 Restoring Factory Settings

This topic describes how to restore factory settings for the SmartLogger on the monitoring panel. After this operation, all parameters, excluding the current date and time, will restore to the default factory settings. However, the running information, alarm records, and system logs do not change.

Context



NOTICE

- After restoring factory settings for the SmartLogger, set the user parameters and communications parameters in time and log in to the WebUI to set the environmental monitoring instrument parameters and power grid dispatching parameters.
- The displayed language is **English** by default.

Procedure

- The following table describes the procedure for restoring factory settings. The parameter values in the following figures are for reference only.

| LCD | Operation Procedure |
|-----|---|
| | <p>1. On the default page, press to enter the main menu.</p> |
| | <p>2. Choose and press .</p> |

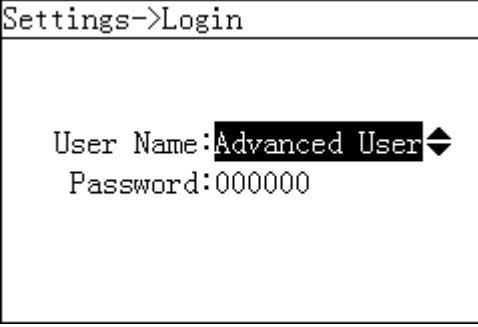
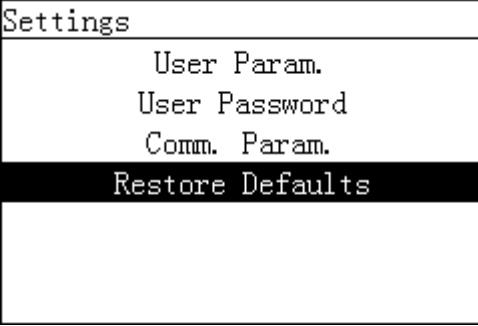
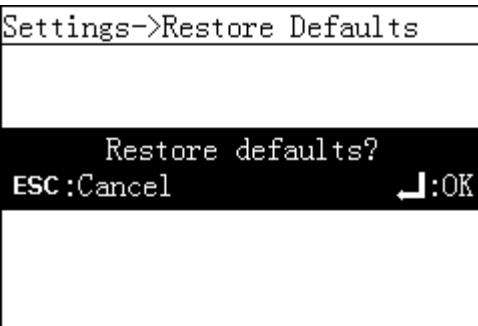
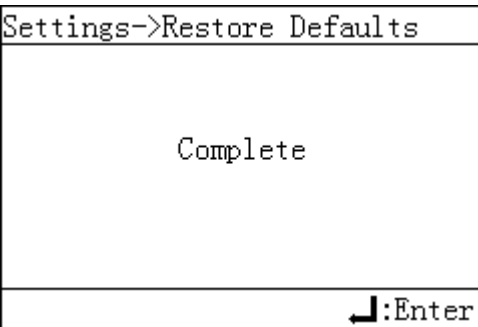
| LCD | Operation Procedure |
|---|--|
|  <p>Settings->Login</p> <p>User Name: Advanced User Password: 000000</p> | <p>3. Enter the User Name and Password by pressing ▲ or ▼, and then press ↵.</p> <p>NOTE</p> <ul style="list-style-type: none"> Because of the limited permission, select the User Name as Advanced User or Special User. The initial password for Advanced User and Special User is 000001. After passing the permission validation, the system keeps the authentication information for 30 seconds. If you exit from the Settings page and log in again within 30 seconds, no authentication is required. |
|  <p>Settings</p> <p>User Param. User Password Comm. Param. Restore Defaults</p> <p>Here use the pages displayed when you log in to the SmartLogger as Advanced User.</p> | <p>4. Choose Restore Defaults, and press ↵.</p> |
|  <p>Settings->Restore Defaults</p> <p>Restore defaults? ESC:Cancel ↵:OK</p> | <p>5. On the displayed page, press ↵.</p> |
|  <p>Settings->Restore Defaults</p> <p>Complete</p> <p>↵:Enter</p> | <p>6. Press ↵ to complete the settings.</p> |

----End

6.2.24 Downloading Data by Using a USB Flash Drive









This topic describes how to use a USB flash drive to download data on the monitoring panel, such as the performance data, operation logs, commissioning logs of the SmartLogger and the alarm records of all the inverters. It provides reference for backtracking and problem analysis.

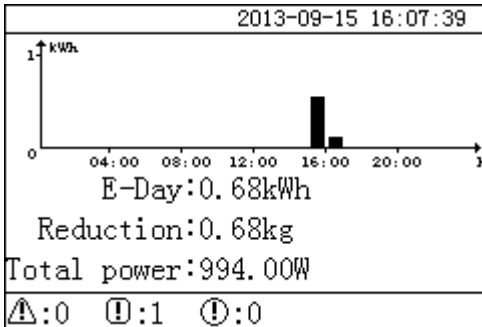

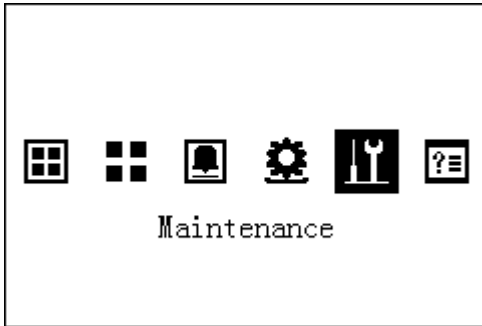

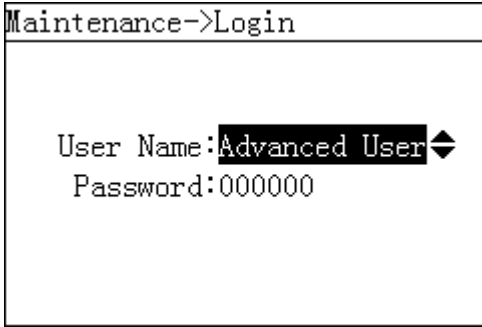

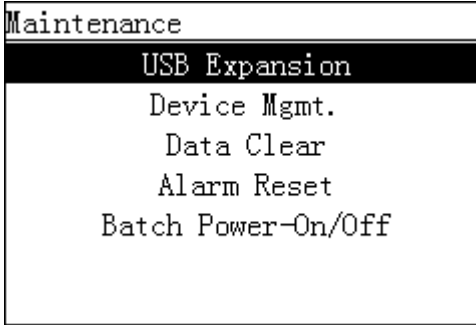

Context

[Side View of the shell](#) shows the USB port in the SmartLogger.

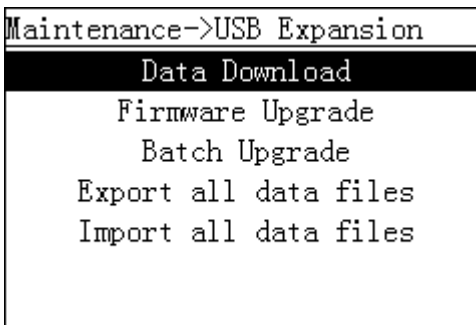
Procedure

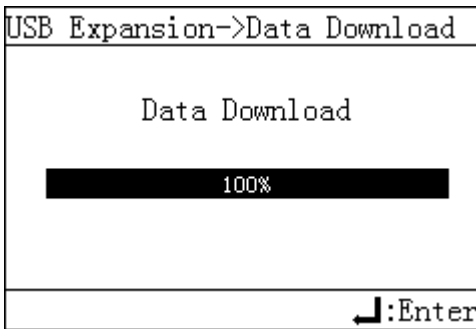
- The following table describes the procedure for using a USB flash drive to download data. The parameter values in the following figures are for reference only.

| LCD | Operation Procedure |
|---|--|
|  | <p>1. On the default page, press  to enter the main menu.</p> |
|  | <p>2. Select  and press .</p> |
|  | <p>3. Enter the User Name and Password by pressing  or , and then press .</p> <p>NOTE</p> <ul style="list-style-type: none"> Because of the limited permission, select the User Name as Advanced User or Special User. The initial password for Advanced User and Special User is <i>000001</i>. After passing the permission validation, the system keeps the authentication information for 30 seconds. If you exit from the Maintenance page and log in again within 30 seconds, no authentication is required. |

| LCD | Operation Procedure |
|--|---|
|  <p>Maintenance</p> <p>USB Expansion</p> <p>Device Mgmt. Data Clear Alarm Reset Batch Power-On/Off</p> <p>Here use the pages displayed when you log in to the SmartLogger as Advanced User.</p> | <p>4. Select USB Expansion and press .</p> <p>NOTE</p> <ul style="list-style-type: none"> • Before this operation, connect the USB flash drive to the USB port. • If no USB flash drive is detected, the LCD displays a message prompting No USB device detected.. <p>The system takes 5 to 10 seconds to detect the USB flash drive. Then perform the following steps.</p> |
|  <p>Maintenance->USB Expansion</p> <p>Data Download</p> <p>Firmware Upgrade Batch Upgrade Export all data files Import all data files</p> | <p>5. Select Data Download and press .</p> |
|  <p>USB Expansion->Data Download</p> <p>Data Download</p> <p> 100%</p> <p>:Enter</p> | <p>6. When the progress bar reaches 100%, press .</p> |

----End

6.2.25 Upgrading Firmware by Using a USB Flash Drive

You can upgrade the firmware on the monitoring panel by using a USB flash drive. You can upgrade the firmware of the SmartLogger and devices connected to the SmartLogger.

Context







NOTICE

- Before upgrading the firmware, download the upgrade package from <http://support.huawei.com> and copy it to your USB flash drive.
- Save the package under the root directory and do not extract the package.
- When upgrading the firmware for the SUN2000, change the file name of the package to **sun2000_usb.zip**.
- When upgrading the firmware for the SUN8000, change the file name of the package to **sun8000_usb.tar.gz**.
- When upgrading the firmware for an AC combiner box, change the file name of the package to **acbox_usb.zip**.
- When upgrading the firmware for the PID, change the file name of the package to **pid_usb.zip**.
- When upgrading the firmware for the PLC, change the file name of the package to **plc_usb.zip**.
- When upgrading the SmartLogger1000, ensure that the file name of the package is **logger_usb.tar.gz**.

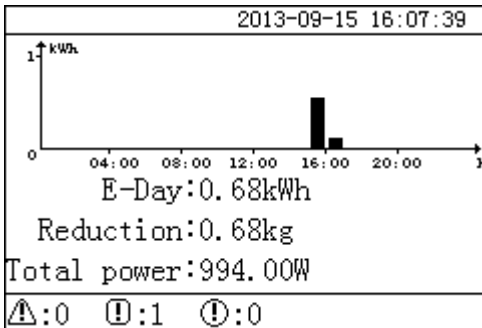
Procedure

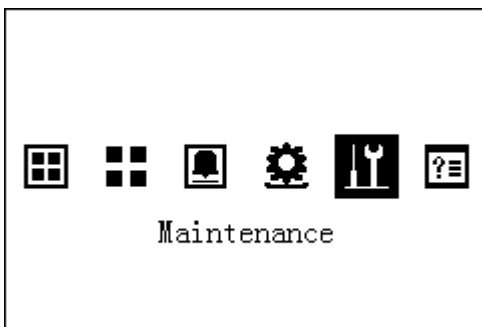
- The following table describes the procedure for upgrading the firmware by using a USB flash drive. The parameter values in the figures are for reference only.

| LCD | Operation Procedure |
|---|---|
|  | <p>1. On the default page, press  to enter the main menu.</p> |
|  | <p>2. Select  and press .</p> |

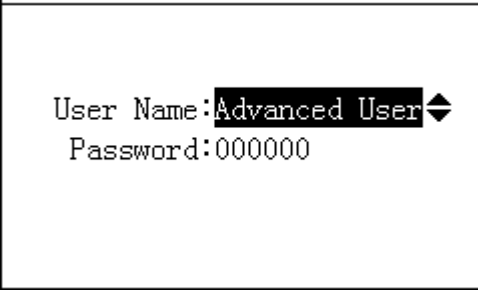
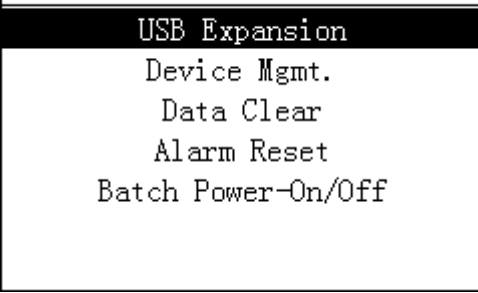
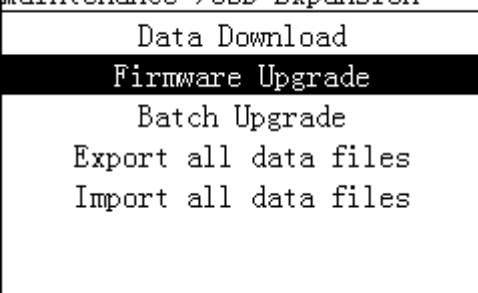
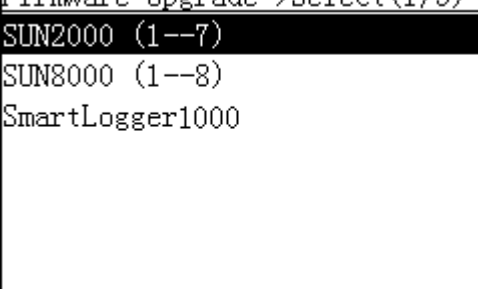
| LCD | Operation Procedure |
|---|--|
| <p>Maintenance->Login</p>  <p>User Name: Advanced User Password: 000000</p> | <p>3. Enter the User Name and Password by pressing ▲ or ▼, and then press ↵.</p> <p>NOTE</p> <ul style="list-style-type: none"> Because of the limited permission, select the User Name as Advanced User or Special User. The initial password for Advanced User and Special User is <i>000001</i>. After passing the permission validation, the system keeps the authentication information for 30 seconds. If you exit from the Maintenance page and log in again within 30 seconds, no authentication is required. |
| <p>Maintenance</p>  <p>USB Expansion Device Mgmt. Data Clear Alarm Reset Batch Power-On/Off</p> <p>Here use the pages displayed when you log in to the SmartLogger as Advanced User.</p> | <p>4. Select USB Expansion and press ↵.</p> <p>NOTE</p> <ul style="list-style-type: none"> Before this operation, connect the USB flash drive to the USB port. If no USB flash drive is detected, the LCD displays a message prompting No USB device detected. <p>The system takes 5 to 10 seconds to detect the USB flash drive. Then perform the following steps.</p> |
| <p>Maintenance->USB Expansion</p>  <p>Data Download Firmware Upgrade Batch Upgrade Export all data files Import all data files</p> | <p>5. Choose Firmware Upgrade, and press ↵.</p> |
| <p>Firmware Upgrade->Select (1/3)</p>  <p>SUN2000 (1--7) SUN8000 (1--8) SmartLogger1000</p> | <p>6. Press ↵ to select a specific device.</p> <p>The SmartLogger and the inverters connected to it can be upgraded.</p> <p>The SUN2000 (1--7) on the left indicates that this inverter connects to the Port 1 of the SmartLogger and the communications address for the RS485 port is 7.</p> |

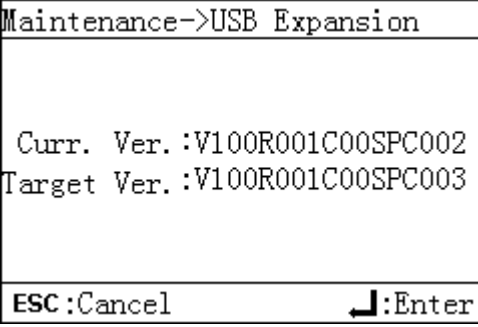
| LCD | Operation Procedure |
|--|--|
|  <p>Maintenance->USB Expansion</p> <p>Curr. Ver. :V100R001C00SPC002 Target Ver. :V100R001C00SPC003</p> <p>ESC :Cancel ↵:Enter</p> <p>(The inverter upgrade screen is used as an example.)</p> | <p>7. After checking that Target Ver. is correct, press ↵.</p> <p>NOTICE For the SUN2000, its firmware can be upgraded only if the device status is On-grid or Shutdown. Check the device status before firmware upgrade.</p> <p>The SmartLogger, inverter, PLC, or PID will restart after being upgraded.</p> |



----End



6.2.26 Batch Upgrade

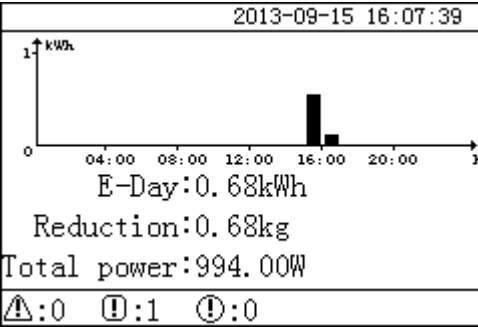
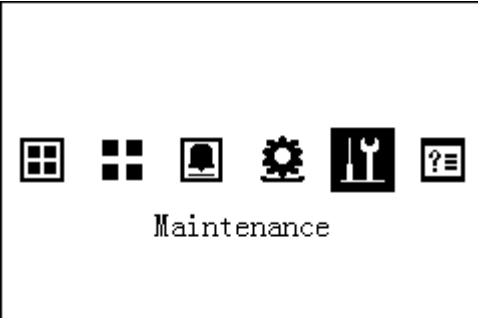

This topic describes how to perform a batch upgrade for the SUN2000 on the monitoring panel.

Procedure

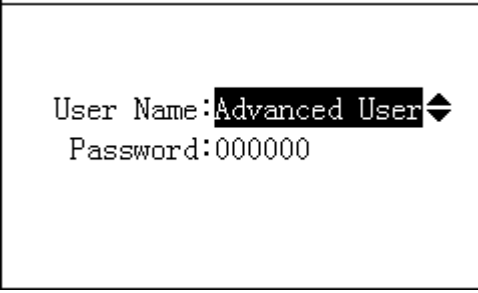
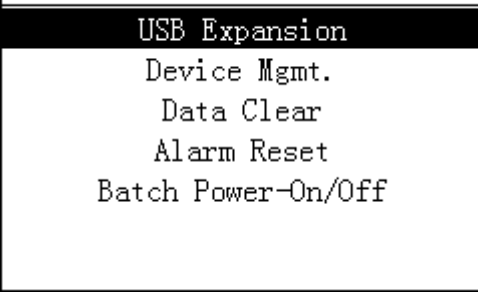
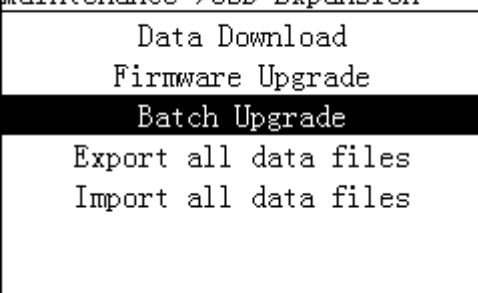
- The following table describes the batch upgrade procedure. The parameter values in the figures are for reference only.

| LCD | Procedure |
|--|---|
|  <p>2013-09-15 16:07:39</p> <p>1↑ kWh</p> <p>04:00 08:00 12:00 16:00 20:00 h</p> <p>E-Day:0.68kWh Reduction:0.68kg Total power:994.00W</p> <p>⚠:0 ⓘ:1 ⓘ:0</p> | <p>1. On the default page, press ↵ to enter the main menu.</p> |
|  <p>Maintenance</p> | <p>2. Select  and press ↵.</p> |

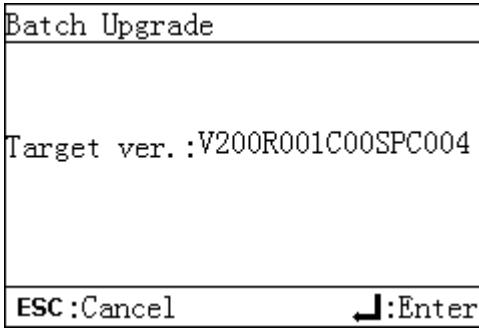
| LCD | Procedure |
|---|--|
| <p>Maintenance->Login</p>  <p>User Name: Advanced User Password: 000000</p> | <p>3. Enter the User Name and Password by pressing ▲ or ▼, and then press ↵.</p> <p>NOTE</p> <ul style="list-style-type: none"> Because of the limited permission, select the User Name as Advanced User or Special User. The initial password for Advanced User and Special User is <i>000001</i>. After passing the permission validation, the system keeps the authentication information for 30 seconds. If you exit from the Maintenance page and log in again within 30 seconds, no authentication is required. |
| <p>Maintenance</p>  <p>USB Expansion Device Mgmt. Data Clear Alarm Reset Batch Power-On/Off</p> <p>Here use the pages displayed when you log in to the SmartLogger as Advanced User.</p> | <p>4. Select USB Expansion and press ↵.</p> <p>NOTE</p> <ul style="list-style-type: none"> Before this operation, connect the USB flash drive to the USB port. If no USB flash drive is detected, the LCD displays a message prompting No USB device detected. <p>The system takes 5 to 10 seconds to detect the USB flash drive. Then perform the following steps.</p> |
| <p>Maintenance->USB Expansion</p>  <p>Data Download Firmware Upgrade Batch Upgrade Export all data files Import all data files</p> | <p>5. Choose Batch Upgrade, and press ↵.</p> |
| <p>Batch Upgrade</p>  <p>SUN2000</p> | <p>6. Choose SUN2000, and press ↵.</p> |

| LCD | Procedure |
|---|--|
|  | <p>7. After checking that Target ver. is correct, press .</p> <p>NOTICE</p> <ul style="list-style-type: none"> • For the SUN2000, its firmware can be upgraded only if the device status is On-grid or Shutdown. Check the device status before firmware upgrade. • The upgrade takes 20 minutes when the baud rate is 9600 bps. • After the upgrade is successful, the SUN2000 automatically restarts. |

----End

6.2.27 Exporting All Files



You can export all files from the SmartLogger on the monitoring panel.







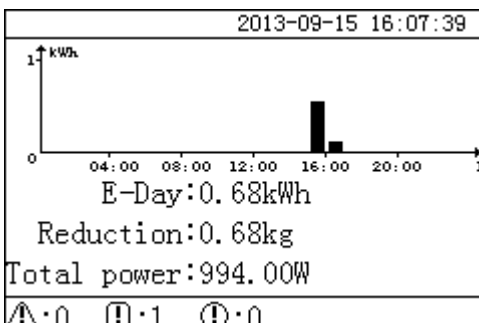

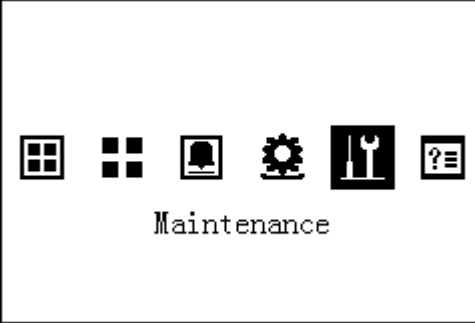

Context

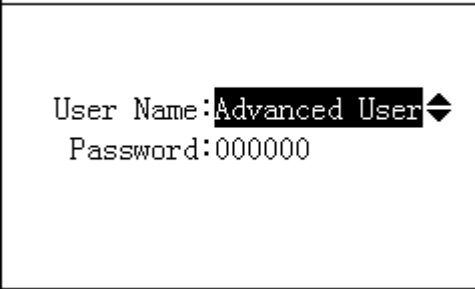
If the SmartLogger needs to be replaced, you can export all files before the replacement and then import the exported files to the new SmartLogger to ensure data integrity.

Procedure

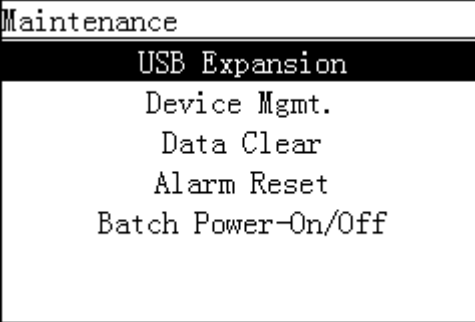
- The following table describes the procedure for exporting all files. The parameter values in the figures are for reference only.

| LCD | Procedure |
|---|--|
|  | <p>1. On the default page, press  to enter the main menu.</p> |

| LCD | Procedure |
|---|--|
|  <p>Maintenance</p> | <p>2. Select  and press .</p> |
| <p>Maintenance->Login</p>  <p>User Name: Advanced User  Password: 000000</p> | <p>3. Enter the User Name and Password by pressing  or , and then press .</p> <p>NOTE</p> <ul style="list-style-type: none"> Because of the limited permission, select the User Name as Advanced User or Special User. The initial password for Advanced User and Special User is <i>000001</i>. After passing the permission validation, the system keeps the authentication information for 30 seconds. If you exit from the Maintenance page and log in again within 30 seconds, no authentication is required. |
| <p>Maintenance</p>  <p>USB Expansion Device Mgmt. Data Clear Alarm Reset Batch Power-On/Off</p> <p>Here use the pages displayed when you log in to the SmartLogger as Advanced User.</p> | <p>4. Select USB Expansion and press .</p> <p>NOTE</p> <ul style="list-style-type: none"> Before this operation, connect the USB flash drive to the USB port. If no USB flash drive is detected, the LCD displays a message prompting No USB device detected.. <p>The system takes 5 to 10 seconds to detect the USB flash drive. Then perform the following steps.</p> |
| <p>Maintenance->USB Expansion</p>  <p>Data Download Firmware Upgrade Batch Upgrade Export all data files Import all data files</p> | <p>5. Select Export all data files and press .</p> |

----End

6.2.28 Importing All Files







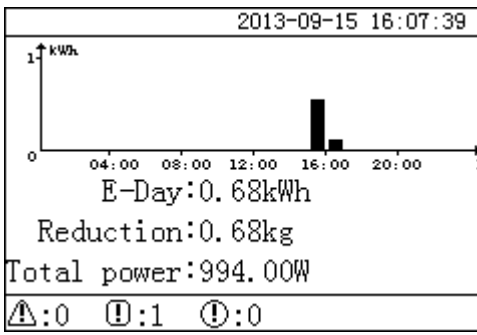

You can import all files to the SmartLogger on the monitoring panel.

Context

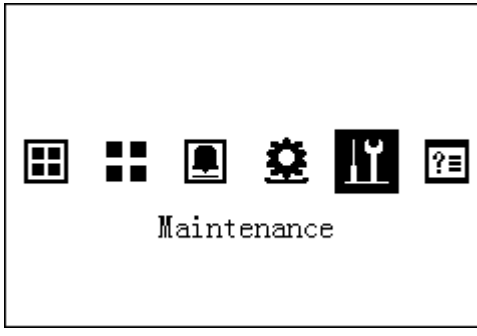
If the SmartLogger needs to be replaced, you can export all files before the replacement and then import the exported files to the new SmartLogger to ensure data integrity.

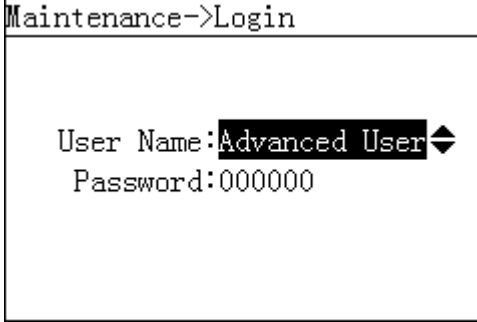
Procedure

- The following table describes the procedure for importing all files. The parameter values in the figures are for reference only.

| LCD | Procedure |
|---|---|
|  | <p>1. On the default page, press  to enter the main menu.</p> |
|  | <p>2. Select  and press .</p> |
|  | <p>3. Enter the User Name and Password by pressing  or , and then press .</p> <p>NOTE</p> <ul style="list-style-type: none"> Because of the limited permission, select the User Name as Advanced User or Special User. The initial password for Advanced User and Special User is <i>000001</i>. After passing the permission validation, the system keeps the authentication information for 30 seconds. If you exit from the Maintenance page and log in again within 30 seconds, no authentication is required. |

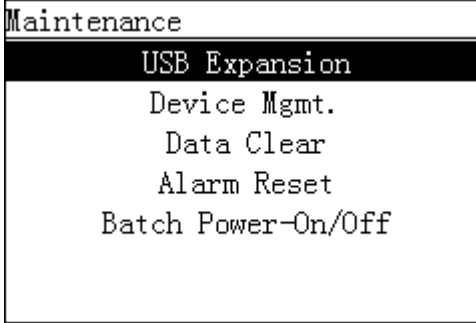
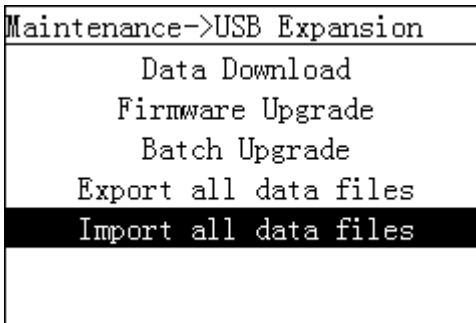
| LCD | Procedure |
|---|---|
|  <p>Maintenance</p> <p>USB Expansion</p> <p>Device Mgmt.</p> <p>Data Clear</p> <p>Alarm Reset</p> <p>Batch Power-On/Off</p> <p>Here use the pages displayed when you log in to the SmartLogger as Advanced User.</p> | <p>4. Select USB Expansion and press ↵.</p> <p>NOTE</p> <ul style="list-style-type: none"> • Before this operation, connect the USB flash drive to the USB port. • If no USB flash drive is detected, the LCD displays a message prompting No USB device detected.. <p>The system takes 5 to 10 seconds to detect the USB flash drive. Then perform the following steps.</p> |
|  <p>Maintenance->USB Expansion</p> <p>Data Download</p> <p>Firmware Upgrade</p> <p>Batch Upgrade</p> <p>Export all data files</p> <p>Import all data files</p> | <p>5. Select Import all data files and press ↵.</p> |

----End

6.2.29 Managing Devices

You can search, add, delete, and assign addresses to devices that are connected to the SmartLogger on the monitoring panel.

Context









- Provided that all the inverters are correctly connected to the SmartLogger and that all the communications parameters are correctly set, the SmartLogger can perform the automatic search and detect all the connected inverters.
- Before you perform the **Auto. Search** operation, if the SmartLogger is connected to devices that no longer exist in the PV power system, remove them from the SmartLogger manually. Otherwise, these devices are still detectable with **Disconnection** status.
- After you add, delete, or replace a device, or change the RS485 address, search for devices again or restart the SmartLogger (the SmartLogger automatically searches for devices after it restarts).
- EMI, slave SmartLogger, power meter, PLC, and third-party devices cannot be automatically recognized, and must be manually added.
- For devices that no longer exist in the PV power system, perform **Single Remove** or **Batch Remove** in time to avoid wasting the system resources.
- The RS485 addresses of all inverters are the same when delivered. If the firmware version of the SUN2000 is V100R001C00SPC010 or later, you can perform automatic

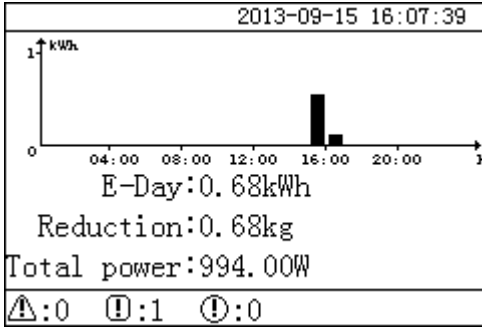

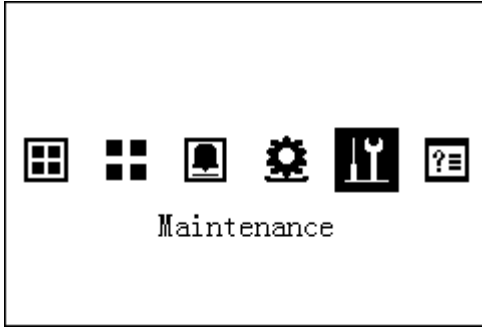
address assignment on the SmartLogger and adjust the addresses to realize remote site setup and improve maintenance efficiency.

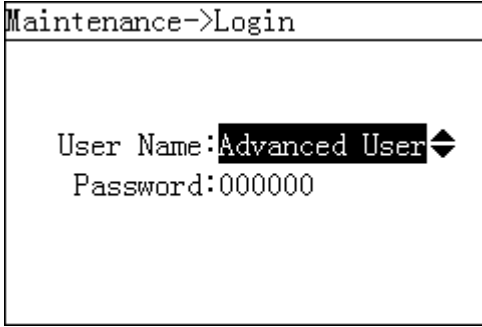

- When connecting a third-party device, you need to import a configuration file for the device, and then manually add the device.



Procedure

- The following table describes the procedure for managing the devices. The parameter values in the following figures are for reference only.

| LCD | Operation Procedure |
|---|---|
|  | <p>1. On the default page, press  to enter the main menu.</p> |
|  | <p>2. Select  and press .</p> |
|  | <p>3. Enter the User Name and Password by pressing  or , and then press .</p> <p>NOTE</p> <ul style="list-style-type: none"> • Because of the limited permission, select the User Name as Advanced User or Special User. The initial password for Advanced User and Special User is <i>000001</i>. • After passing the permission validation, the system keeps the authentication information for 30 seconds. If you exit from the Maintenance page and log in again within 30 seconds, no authentication is required. |

| LCD | Operation Procedure |
|---|---|
| <pre> Maintenance USB Expansion Device Mgmt. Data Clear Alarm Reset Batch Power-On/Off </pre> | <p>4. Select Device Mgmt. and press .</p> <ul style="list-style-type: none"> • Perform step 5 to enable the SmartLogger to automatically search for devices. • Perform step 6 to add devices to the SmartLogger. • Perform step 7 to remove a single device. • Perform step 8 to remove devices in batches. • Perform steps 9-11 to assign addresses to devices. • Perform step 12 to import a configuration file. • Perform step 13 to enable the Auto device access function. |
| <pre> Maintenance->Device Mgmt. Auto. Search Add Manually Single Remove Batch Remove Addr. Allocate Config Import Auto device access </pre> <p style="text-align: center;">↓</p> <pre> Device Mgmt.->Auto. Search Devices already exist: 4 Search again? ESC:Cancel ↵:Enter </pre> | <p>5. Select Auto. Search, and press .</p> <p>Before performing the automatic search, ensure that all the devices can normally communicate with the SmartLogger.</p> <p>NOTE</p> <ul style="list-style-type: none"> • After you add, delete, or replace a device, or change the RS485 address, search for devices again. • If a device is added, search for the device on the SmartLogger or restart the SmartLogger and then search for the device on the NetEco1000. |

| LCD | Operation Procedure |
|--|---|
| <div style="border: 1px solid black; padding: 5px;"> <p>Maintenance->Device Mgmt.</p> <p style="text-align: center;">Auto. Search</p> <p style="text-align: center;">Add Manually</p> <p style="text-align: center;">Single Remove</p> <p style="text-align: center;">Batch Remove</p> <p style="text-align: center;">Addr. Allocate</p> <p style="text-align: center;">Config Import</p> <p style="text-align: center;">Auto device access</p> <p style="text-align: center;">↓</p> </div> <div style="border: 1px solid black; padding: 5px;"> <p>Device Mgmt. ->Add Manually</p> <p>Device type: SUN2000</p> <p>Comm. protocol: Modbus-RTU</p> <p>Port number: 1</p> <p>Address: 001</p> </div> | <p>6. Select Add Manually and press .</p> <p>NOTE</p> <ul style="list-style-type: none"> • EMI, slave SmartLogger, power meter, PLC, and third-party devices must be manually added. • If the communication is abnormal, or the address on the port has been used, the device cannot be added. |
| <div style="border: 1px solid black; padding: 5px;"> <p>Maintenance->Device Mgmt.</p> <p style="text-align: center;">Auto. Search</p> <p style="text-align: center;">Add Manually</p> <p style="text-align: center;">Single Remove</p> <p style="text-align: center;">Batch Remove</p> <p style="text-align: center;">Addr. Allocate</p> <p style="text-align: center;">Config Import</p> <p style="text-align: center;">Auto device access</p> <p style="text-align: center;">↓</p> </div> <div style="border: 1px solid black; padding: 5px;"> <p>Single Remove->Select(4/4)</p> <p>SUN2000(1-1)</p> <p>PID(1-2)</p> <p style="text-align: center;">Custom Device1(3-1)</p> </div> | <p>7. Select Single Remove and press  twice.</p> <p>NOTE</p> <p>For devices that no longer exist in the PV power system, remove them in time to avoid wasting system resources.</p> |

| LCD | Operation Procedure |
|---|---|
| <pre> Maintenance->Device Mgmt. Auto. Search Add Manually Single Remove Batch Remove Addr. Allocate Config Import Auto device access ↓ Device Mgmt. ->Batch Remove ↓ Batch remove all devices? ESC:Cancel ↵:Enter </pre> | <p>8. Select Batch Remove and , and confirm the batch removal operation.</p> <p>NOTE For devices that no longer exist in the PV power system, remove them in time to avoid wasting system resources.</p> |
| <pre> Maintenance->Device Mgmt. Auto. Search Add Manually Single Remove Batch Remove Addr. Allocate Config Import Auto device access ↓ Addr. Allocate->Addr. Allocate RS485-1 start addr.:11 RS485-2 start addr.:41 RS485-3 start addr.:71 </pre> | <p>9. Select Addr. Allocate, set the start addresses assigned for RS485-1, RS485-2, and RS485-3, and then press  to allocate the addresses.</p> |

| LCD | Operation Procedure |
|---|--|
| <p>...->Addr. Adjustment</p> <hr/> <p>Adjust the address? ESC:Cancel ↵:Enter</p> <p style="text-align: center;">↓</p> <p>...->Addr. Adjustment</p> <p>AM0107164901D2001224:2-002</p> | <p>10. After the setting of Addr. Allocate is completed, press ↵ to adjust addresses.</p> |
| <p>Device Mgmt.->Auto. Search</p> <hr/> <p>Search again? ESC:Cancel ↵:Enter</p> <p style="text-align: center;">↓</p> <p>Device Mgmt.->Auto. Search</p> <p>Search complete. Device found 1 PCS.</p> <hr/> <p style="text-align: right;">↵:Enter</p> | <p>11. After the setting of Addr. Adjustment is completed, press ↵ to search the devices.</p> |

| LCD | Operation Procedure |
|--|--|
| <pre> Maintenance->Device Mgmt. Auto. Search Add Manually Single Remove Batch Remove Addr. Allocate Config Import Auto device access </pre> <p style="text-align: center;">↓</p> <pre> Device Mgmt. ->Config Import Custom Device 1 Custom Device 2 Custom Device 3 Custom Device 4 Custom Device 5 </pre> | <p>12. Select Config Import, select a custom device as required, and press ↵ to import a configuration file.</p> <p>NOTE</p> <ul style="list-style-type: none"> • Before importing a configuration file, you must plug in a USB drive that contains the configuration file. • After importing a configuration file, you need to manually add a third-party device. |
| <pre> Maintenance->Device Mgmt. Auto. Search Add Manually Single Remove Batch Remove Addr. Allocate Config Import Auto device access </pre> <p style="text-align: center;">↓</p> <pre> ...->Auto device access Auto device access:Enable </pre> | <p>13. Select Auto device access, click Enable or Disable, and press ↵.</p> <p>NOTE</p> <p>If the Auto device access function is enabled, the SmartLogger scans the system for new devices once every 10 minutes. New devices automatically connect to the SmartLogger when either of the following conditions is met:</p> <ul style="list-style-type: none"> • No device is connected to the SmartLogger. • The time falls in the range of 00:00 to 04:00, and all inverters are not grid-tied. |

----End

6.2.30 Clearing Data

This topic describes how to delete alarm and performance data on the monitoring panel.

Context

Clear data if the SmartLogger location changes and its historical data need to be deleted.



NOTICE

- After the data clear operation is performed, all information stored on the SmartLogger, including energy yield, performance data, and alarms, will be removed.
- After the data clear operation is performed, the devices connected to the SmartLogger are not removed. If an original device will not connect to the SmartLogger, remove the device.
- If you perform **Data Clear** on the SmartLogger, you also have to perform **Alarm Reset** on the NMS. Otherwise, the alarm information collected by the NMS and SmartLogger will be different.

Procedure

- The following table describes the procedure for clearing data. The parameter values in the figures are for reference only.

| LCD | Operation Procedure |
|-----|---|
| | <p>1. On the default page, press to enter the main menu.</p> |
| | <p>2. Select and press .</p> |

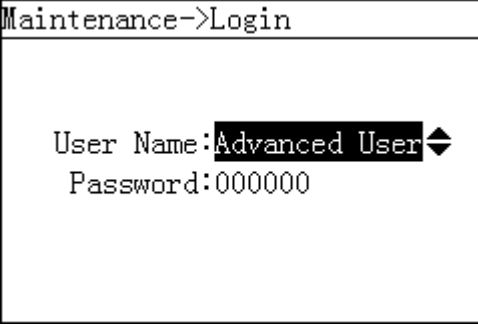
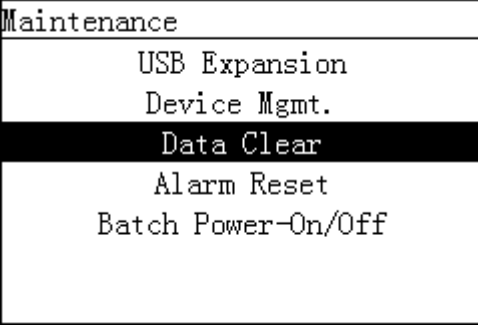
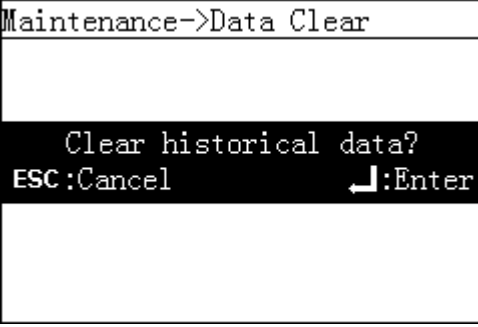
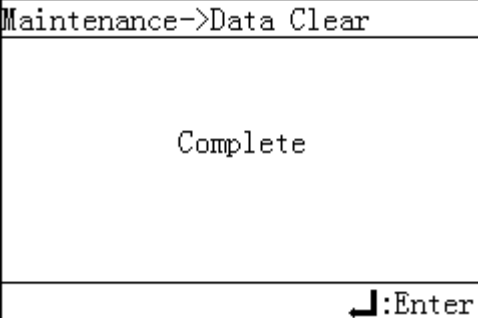
| LCD | Operation Procedure |
|--|--|
|  <p>Maintenance->Login</p> <p>User Name: Advanced User ⬅</p> <p>Password: 000000</p> | <p>3. Enter the User Name and Password by pressing ▲ or ▼, and then press ↵.</p> <p>NOTE</p> <ul style="list-style-type: none"> Because of the limited permission, select the User Name as Advanced User or Special User. The initial password for Advanced User and Special User is <i>000001</i>. After passing the permission validation, the system keeps the authentication information for 30 seconds. If you exit from the Maintenance page and log in again within 30 seconds, no authentication is required. |
|  <p>Maintenance</p> <p>USB Expansion</p> <p>Device Mgmt.</p> <p>Data Clear</p> <p>Alarm Reset</p> <p>Batch Power-On/Off</p> | <p>4. Press ▼, select Data Clear, and press ↵.</p> <p>NOTICE</p> <p>Cleared data cannot be restored. Therefore, perform this operation with caution.</p> |
|  <p>Maintenance->Data Clear</p> <p>Clear historical data?</p> <p>ESC:Cancel ↵:Enter</p> | <p>5. On the displayed screen, press ↵.</p> |
|  <p>Maintenance->Data Clear</p> <p>Complete</p> <p>↵:Enter</p> | <p>6. After the data is cleared, press ↵. No further operation is required.</p> |

----End

6.2.31 Alarm Reset

This topic describes how to reset alarm on the monitoring panel.

Context

If you reset alarms on the LCD, all the active and historical alarms for the inverter are deleted and the SmartLogger starts to collect new alarms.



NOTICE

- If you perform **Data Clear** for inverters, you need to perform **Alarm Reset** for both the SmartLogger and the NetEco1000 at the same time. Otherwise, the SmartLogger cannot collect the alarm information generated by the inverter after **Alarm Reset** is performed.
- If you perform **Alarm Reset** or **Data Clear** for the SmartLogger, you also need to perform **Alarm Reset** for the NetEco1000. Otherwise the NetEco1000 cannot collect the alarm information collected by the SmartLogger after **Alarm Reset** is performed.

Procedure

- The following table describes the procedure for resetting data. The parameter values in the following figures are for reference only.

| LCD | Procedure |
|-----|---|
| | <p>1. On the default page, press to enter the main menu.</p> |
| | <p>2. Select and press .</p> |

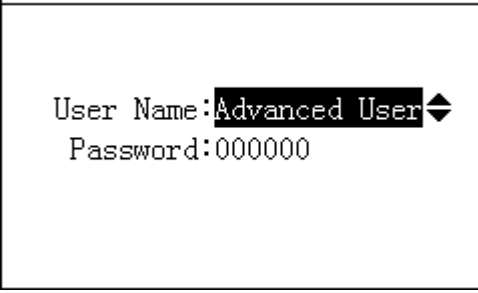
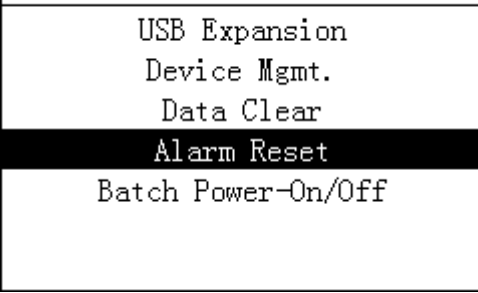
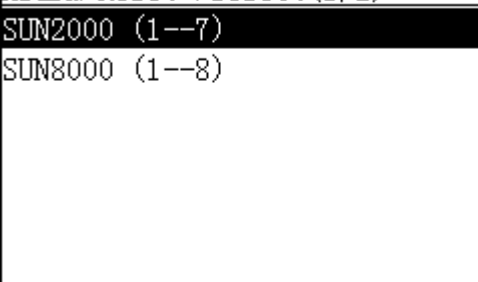
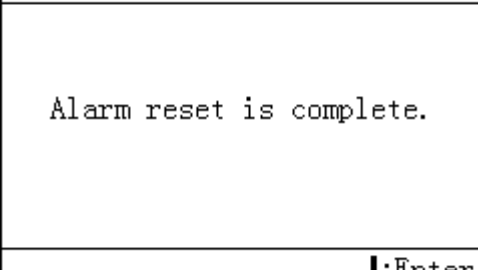
| LCD | Procedure |
|---|--|
| <p>Maintenance->Login</p>  <p>User Name: Advanced User Password: 000000</p> | <p>3. Enter the User Name and Password by pressing ▲ or ▼, and then press ↵.</p> <p>NOTE</p> <ul style="list-style-type: none"> Because of the limited permission, select the User Name as Advanced User or Special User. The initial password for Advanced User and Special User is <i>000001</i>. After passing the permission validation, the system keeps the authentication information for 30 seconds. If you exit from the Maintenance page and log in again within 30 seconds, no authentication is required. |
| <p>Maintenance</p>  <p>USB Expansion Device Mgmt. Data Clear Alarm Reset Batch Power-On/Off</p> | <p>4. Press ▼, choose Alarm Reset, and press ↵.</p> |
| <p>Alarm Reset->Select (1/2)</p>  <p>SUN2000 (1--7) SUN8000 (1--8)</p> | <p>5. Choose the inverter you want to reset alarms for, press ↵.</p> |
| <p>Maintenance->Alarm Reset</p>  <p>Alarm reset is complete.</p> <p>↵:Enter</p> | <p>6. After resetting the data, press ↵.</p> |

----End

6.2.32 Batch Power-On/Off

This topic describes how to perform the batch power-on/off on the monitoring panel.

Context



NOTICE

- The batch power-on/off command sent by the Master SmartLogger is synchronized to the Slave SmartLogger. Hence inverters connected to the Slave SmartLogger also perform the batch power-on/off.
- If a batch power-off command is sent to the inverters, send a batch power-on command to restart the inverters.

Procedure

- The following table describes the procedures of the batch power-on/off. The parameter values in the figures are for reference only.

| LCD | Procedure |
|-----|---|
| | <p>1. On the default page, press to enter the main menu.</p> |
| | <p>2. Select and press .</p> |
| | <p>3. Enter the User Name and Password by pressing or , and then press .</p> <p>NOTE</p> <ul style="list-style-type: none"> • Because of the limited permission, select the User Name as Advanced User or Special User. The initial password for Advanced User and Special User is 000001. • After passing the permission validation, the system keeps the authentication information for 30 seconds. If you exit from the Maintenance page and log in again within 30 seconds, no authentication is required. |

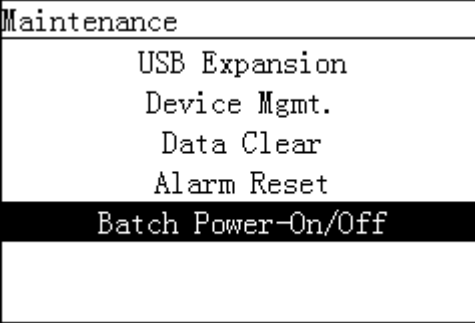
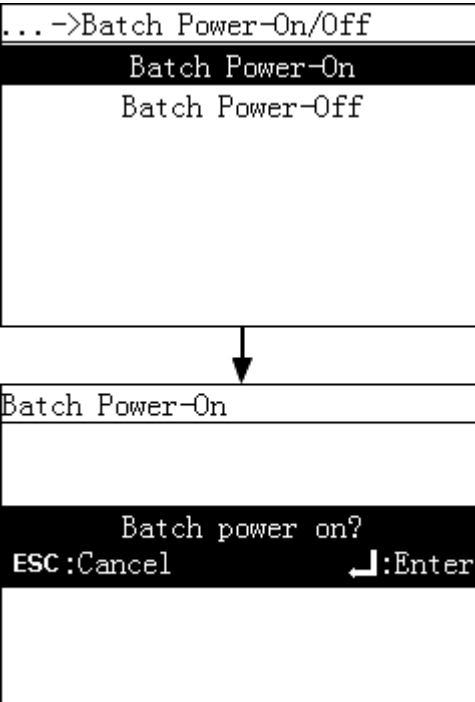
| LCD | Procedure |
|--|---|
|  <p>Maintenance</p> <p>USB Expansion</p> <p>Device Mgmt.</p> <p>Data Clear</p> <p>Alarm Reset</p> <p>Batch Power-On/Off</p> | <p>4. Press ▼, choose Batch Power-On/Off, and press ↵.</p> <ul style="list-style-type: none"> To power on the inverters in batch, go to step 5. To power off the inverters in batch, go to step 6. |
|  <p>... ->Batch Power-On/Off</p> <p>Batch Power-On</p> <p>Batch Power-Off</p> <p>↓</p> <p>Batch Power-On</p> <p>Batch power on?</p> <p>ESC:Cancel ↵:Enter</p> | <p>5. Choose Batch Power-On and press ↵.</p> |

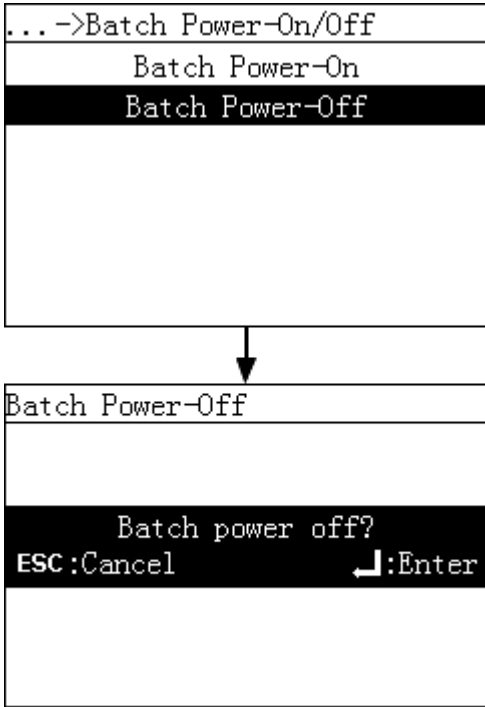
| LCD | Procedure |
|---|--|
|  <p>... ->Batch Power-On/Off Batch Power-On Batch Power-Off</p> <p>↓</p> <p>Batch Power-Off</p> <p>Batch power off? ESC:Cancel ↵:Enter</p> | <p>6. Choose Batch Power-Off and press ↵.</p> |

----End



6.2.33 Querying Product Information

This topic describes how to query the information about the SmartLogger on the monitoring panel, including the device type, firmware version, and serial number.

Procedure

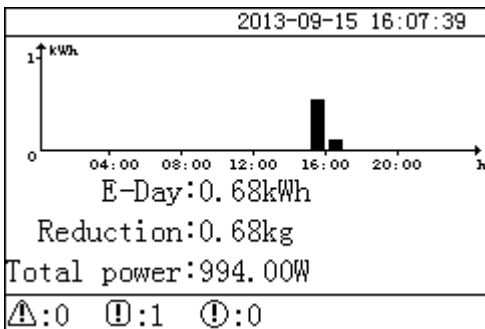
- The following table describes the procedure for querying product information. The parameter values in the following figures are for reference only.

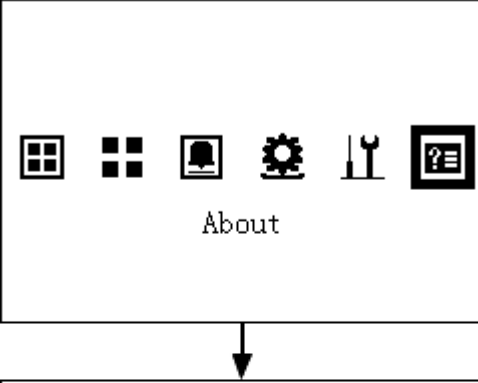
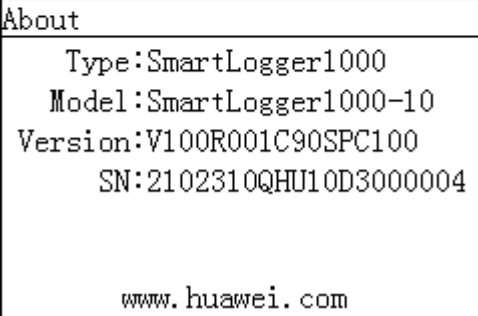
| LCD | Operation Procedure |
|---|--|
|  <p>2013-09-15 16:07:39</p> <p>↑ kWh</p> <p>04:00 08:00 12:00 16:00 20:00 h</p> <p>E-Day:0.68kWh Reduction:0.68kg Total power:994.00W</p> <p>⚠:0 ⓘ:1 ⓘ:0</p> | <p>1. On the default page, press ↵ to enter the main menu.</p> |

| LCD | Operation Procedure |
|---|---|
|  <p data-bbox="595 506 676 533">About</p>  <p data-bbox="395 685 475 712">About</p> <p data-bbox="459 725 783 752">Type:SmartLogger1000</p> <p data-bbox="443 766 831 792">Model:SmartLogger1000-10</p> <p data-bbox="411 806 815 833">Version:V100R001C90SPC100</p> <p data-bbox="491 846 863 873">SN:2102310QHU10D3000004</p> <p data-bbox="515 958 743 985">www.huawei.com</p> | <p data-bbox="898 309 1246 344">2. Choose  and press .</p> <p data-bbox="898 358 1353 421">The version information includes Type, Model, Version, and SN.</p> |

----End

7 Web User Interface

This topic describes how to log in to the Web user interface (WebUI) and the WEB menu, and set parameters and maintain devices on the WebUI.

7.1 Preparations for Login

This topic describes the operating environment for the WebUI and the required preparations before you log in to the WebUI.

Operating Environment

The running environment for the WebUI should meet the following requirements:

- Operating system: Windows.
- Browser: Internet Explorer 7.0, Internet Explorer 8.0, Internet Explorer 9.0, Firefox 17.0, Firefox 18.0, Firefox 19.0, Firefox 20.0, Firefox21.0.
- Minimum resolution: 1024 x 768.

Setting the IP Address

Correctly set the IP address, subnet mask, and gateway for the SmartLogger, PC, and network devices.

Setting the LAN



NOTICE

- If the SmartLogger is connected to a local area network (LAN) and a proxy server has been selected, you need to cancel proxy server setting.
 - If the SmartLogger is connected to the Internet but the computer is connected to the LAN, you cannot cancel proxy server setting.
-

To set the LAN, perform the following steps:

1. Open Internet Explorer.

2. Choose **Tools > Internet Options**.
3. Click the **Connections** tab and then click **LAN settings**, as shown in [Figure 7-1](#).

Figure 7-1 LAN settings (1)

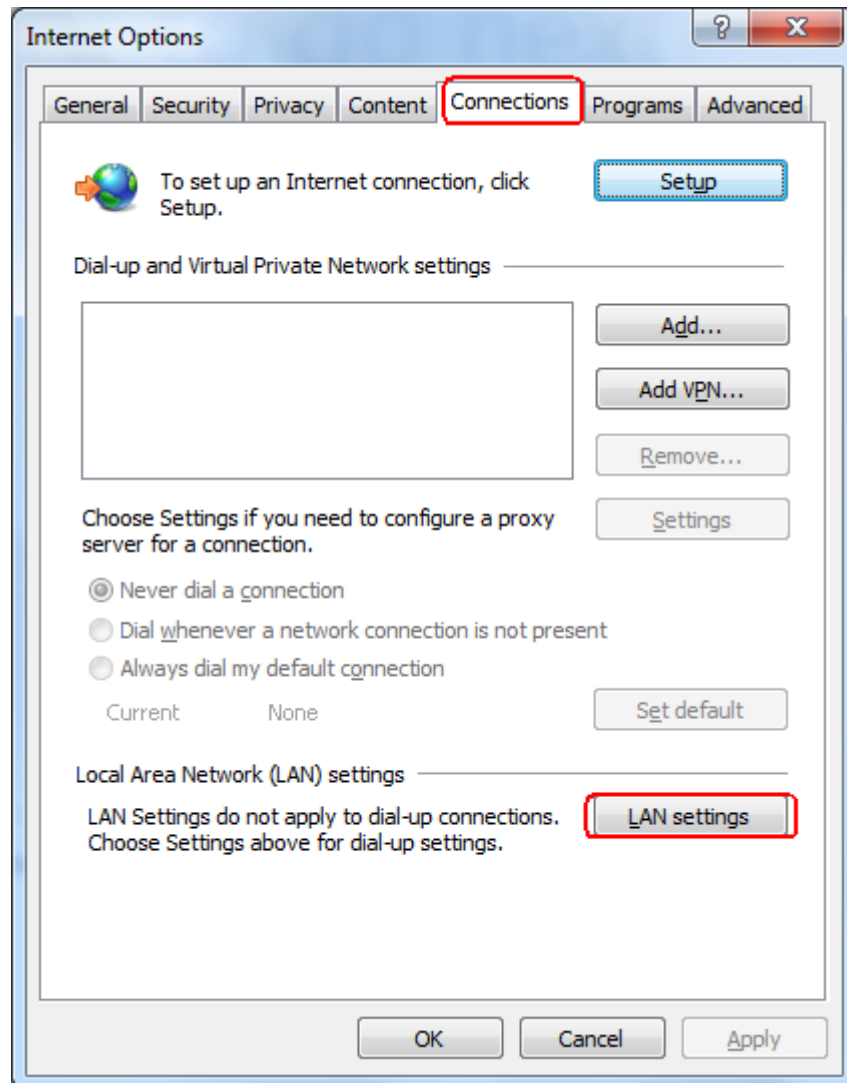

4. Deselect the check box under **Proxy server**, as shown in [Figure 7-2](#).

Figure 7-2 LAN settings (2)



5. Click **OK** to finish the LAN settings.

Setting Internet Explorer Security



NOTICE

If you need to export the fault information and operation logs, set Internet Explorer security.

To set Internet Explorer security, perform the following steps:

1. Open Internet Explorer.
2. Choose **Tools > Internet Options**.
3. Select **Security** and click **Sites** in **Trusted sites**, as shown in [Figure 7-3](#).

Figure 7-3 Internet Explorer security (1)

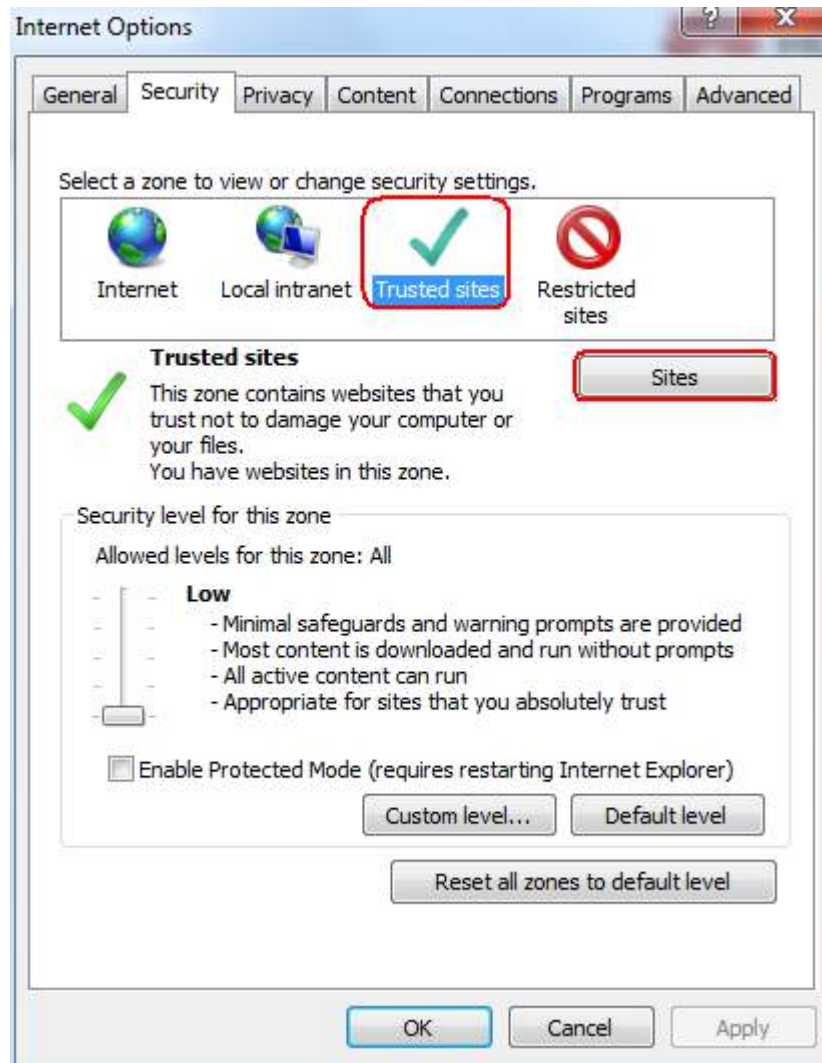

4. After entering the Web address (namely, the IP address for the SmartLogger), click **Add**, as shown in [Figure 7-4](#).

Figure 7-4 Internet Explorer security (3)

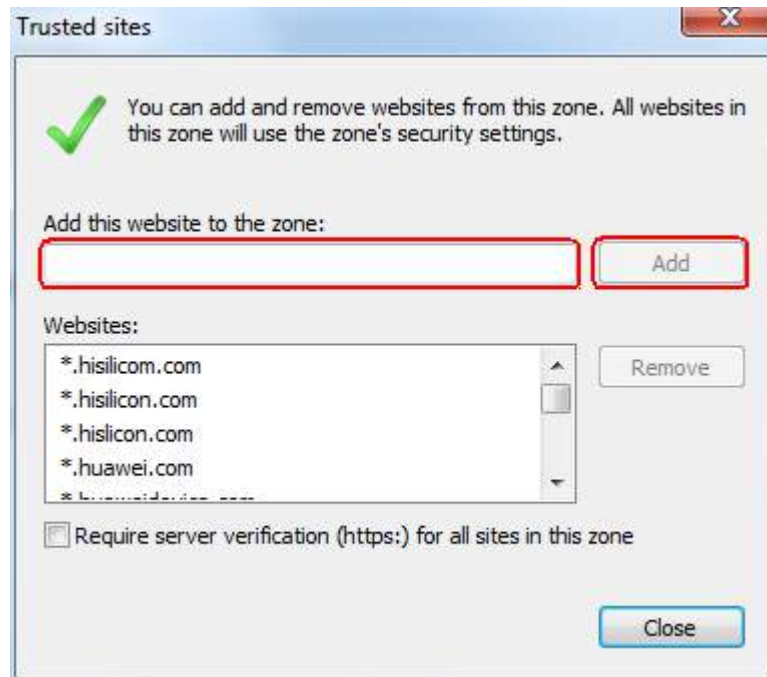

5. Set **Security level for this zone** to **Medium** or **Low**.

Installing a Security Certificate

1. If you log in to the WebUI for the first time, a message as shown in [Figure 7-5](#) is displayed. Click **Continue to this website**.

Figure 7-5 Installing the security certificate (1)

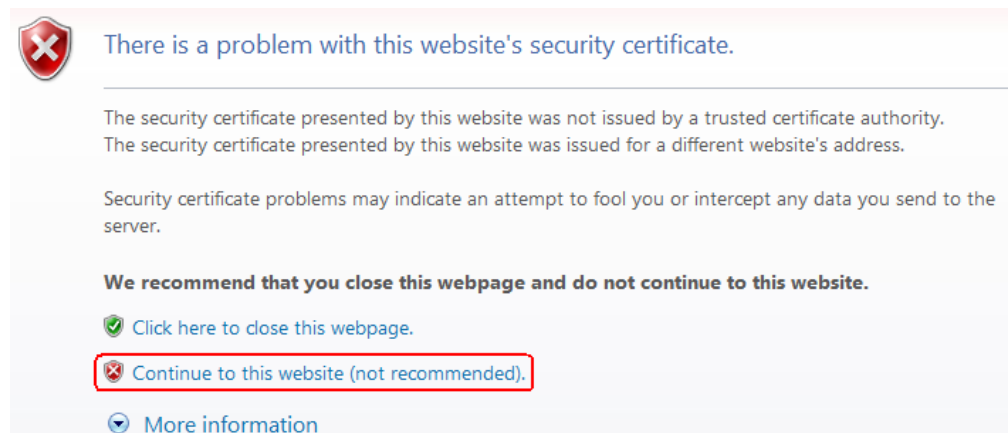

2. Click **Certificate Error** on the right of the address bar and choose **View certificates**, as shown in [Figure 7-6](#).

Figure 7-6 Installing the security certificate (2)

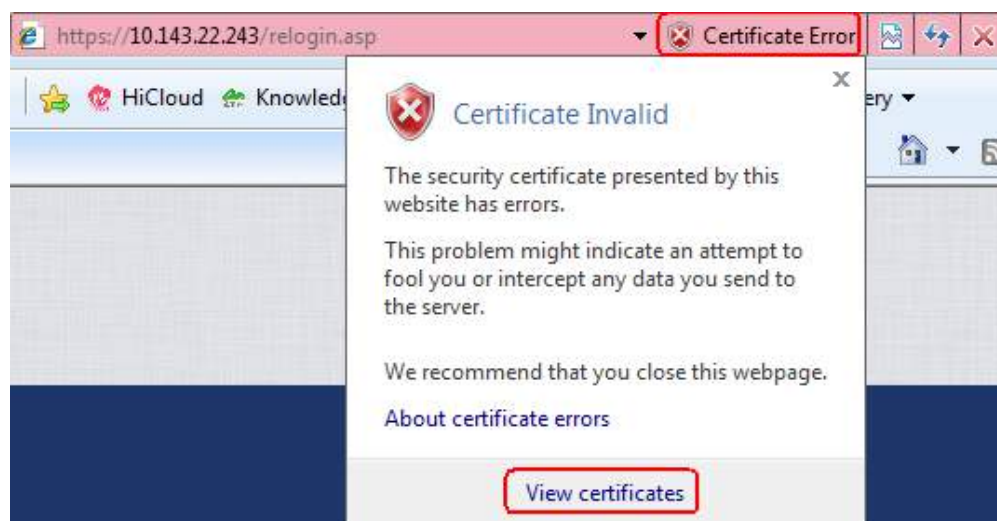

3. Click **Install Certificate**, as shown in [Figure 7-7](#).

Figure 7-7 Installing the security certificate (3)

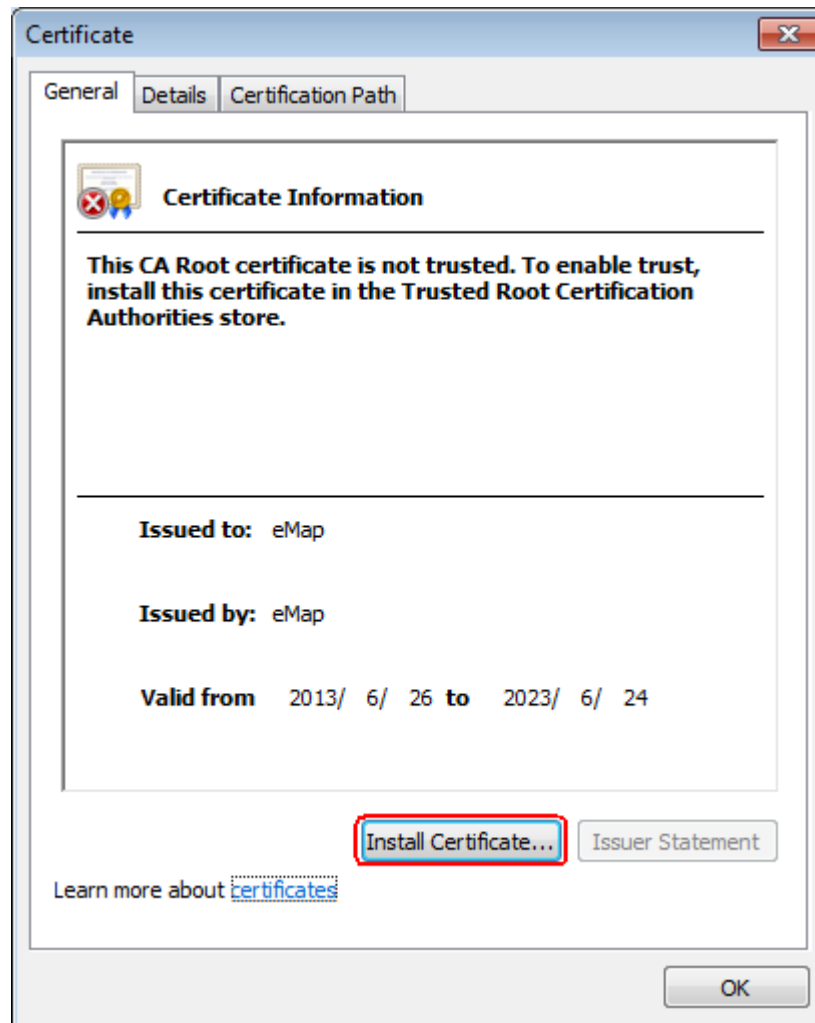

4. Click **Next**.
5. Select **Place all certificates in the following store** and click **Browse**, as shown in [Figure 7-8](#).

Figure 7-8 Installing the security certificate (4)

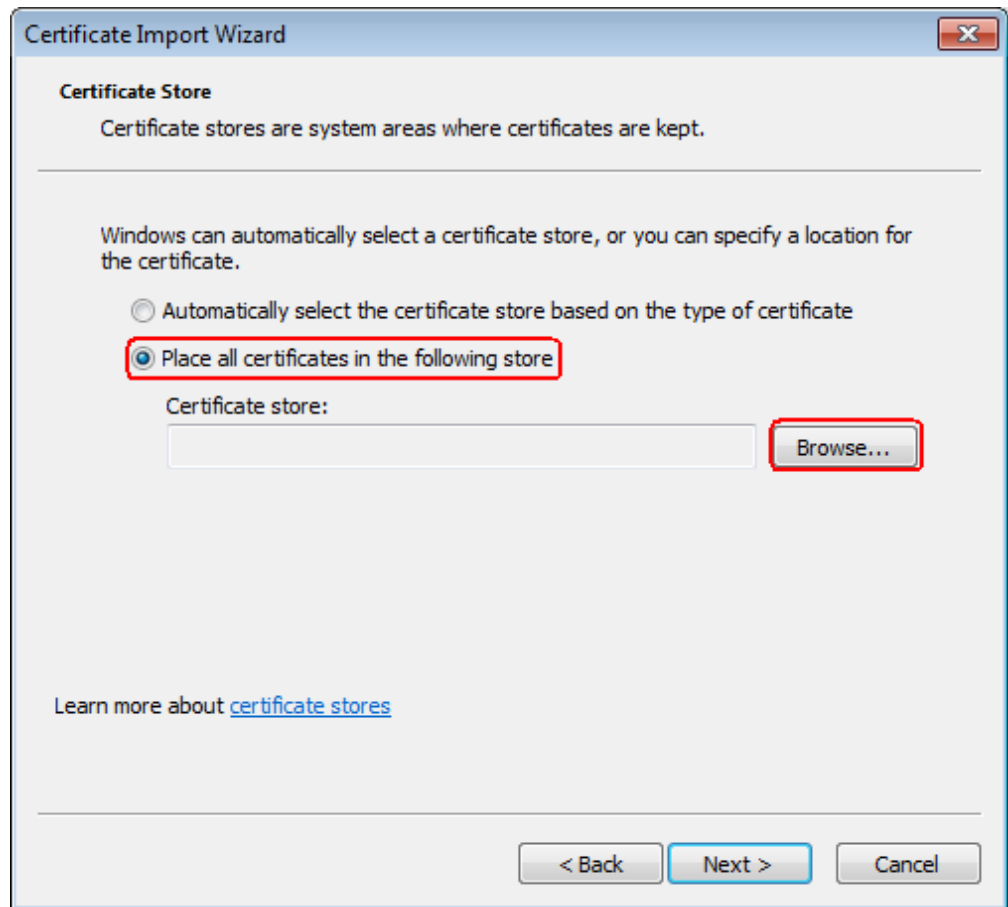

6. Select **Trusted Root Certification Authorities** and click **OK**, as shown in [Figure 7-9](#).

Figure 7-9 Installing the security certificate (5)

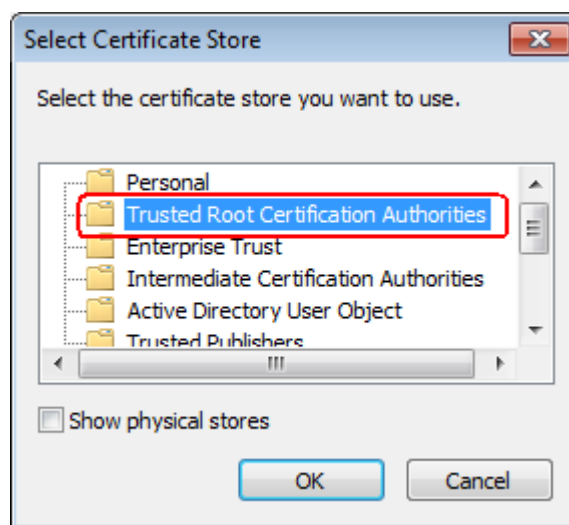

7. Click **Next**.

- Click **Finish**. A security warning dialog box is displayed. Click **Yes**, as shown in [Figure 7-10](#).

Figure 7-10 Installing the security certificate (6)

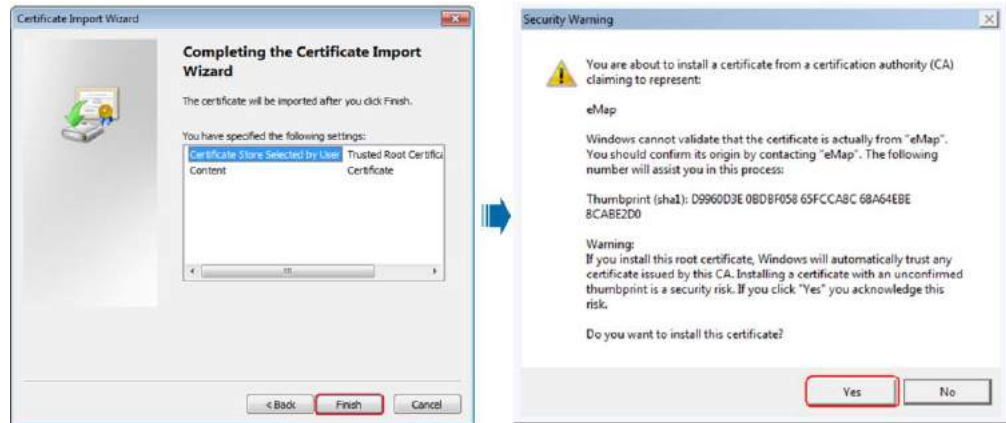

7.2 Logging In to the WebUI

This topic describes how to log in to the WebUI.

Procedure

- Step 1** Connect the SmartLogger to a PC directly or over the Internet. For details about this operation, see [4.7 Connecting the SmartLogger to a PC](#).
- Step 2** Set the IP address, subnet mask, and gateway on the LCD of the SmartLogger.
- Step 3** Enter **https://XX.XX.XX.XX** in the address box of the browser, and press **Enter**. The login page appears, as shown in [Figure 7-11](#). Enter a correct **User Name** and **Password**, select a value for **Language**, and click **Login** to enter the home screen.

Figure 7-11 Login page of the WebUI



 **NOTE**

- XX.XX.XX.XX is the IP address of the SmartLogger, for example, **https://192.168.0.10**.
- There are three roles of the system user: **Common User**, **Advanced User** and **Special User**. The initial password is *000001* in V100R001C95SPC010 or earlier and is *Changeme* in V100R001C95SPC020 or later.
- After the first login, it is recommended that you change the initial password immediately to ensure account security.
- If you enter a wrong password for six times in five minutes, a message "Repeat check fail several times, this account have been locked, please login after an hour!" is displayed.



NOTICE

If the displayed page is blank or the page does not respond when you click any menu after logging in to the WebUI, solve this problem by clearing the cache, refreshing the page, or logging in to the WebUI again.

----End

7.3 WebUI Layout

This section describes the layout of the WebUI.

Figure 7-12 shows the layout of the WebUI.

Figure 7-12 WebUI layout

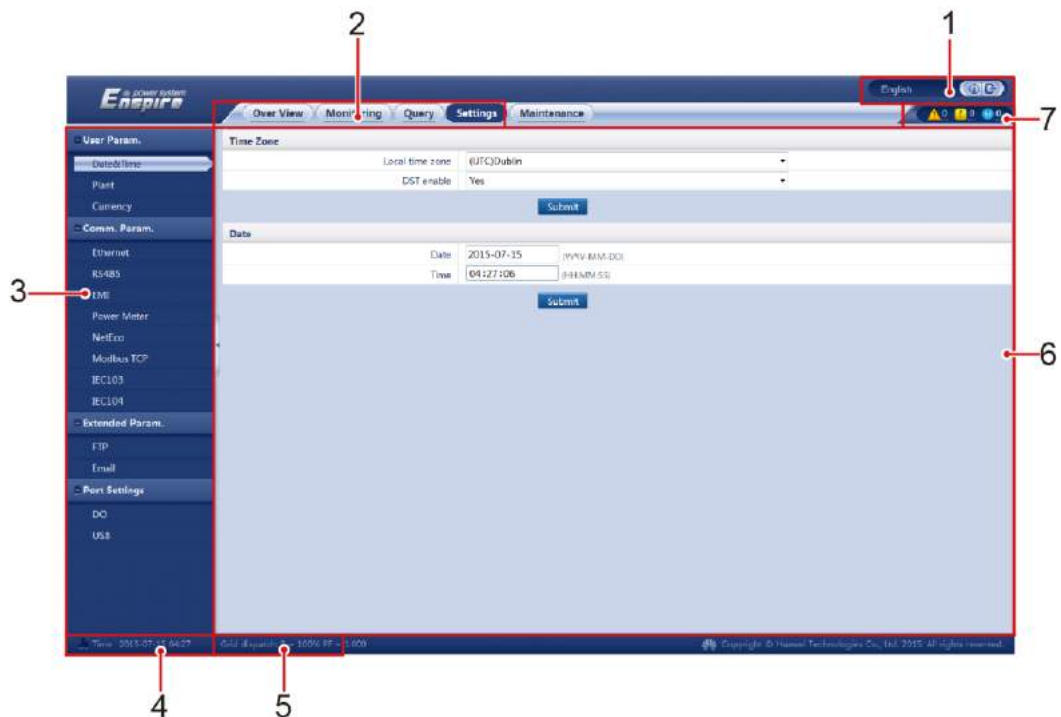

IL01CC0001

Table 7-1 describes the layout of the WebUI shown in Figure 7-12.

Table 7-1 WebUI layout description

| No. | Functions | Description |
|-----|---------------------------|--|
| 1 | Display language | Selects the display language or chooses to log out. |
| 2 | Primary navigation menu | Click the corresponding primary navigation menu before you perform any operation on the WebUI. |
| 3 | Secondary navigation menu | Under the primary navigation menu, choose the device to be queried or the parameter to be set under the secondary navigation menu. |
| 4 | System time | Displays the current system time. |
| 5 | Power grid scheduling | Displays the current power grid scheduling mode of the system. |
| 6 | Page of parameter details | Displays details of the queried information or the parameter setting. |
| 7 | Alarm icon | Displays the severities and number of alarms in the system. You can enter the alarm page by clicking the number. |



NOTE

7.4 WebUI Menu shows the menu tree of the WebUI.

7.4 WebUI Menu

This topic describes the WebUI menu, which allows you to perform operations conveniently.

The WebUI menu consists of five parts: **Over View**, **Monitoring**, **Query**, **Settings** and **Maintenance**. Different identities (**Common User**, **Advanced User**, and **Special User**) have different permissions for setting parameters and maintenance, as shown in Figure 7-13.

Figure 7-13 Structure of the main menu

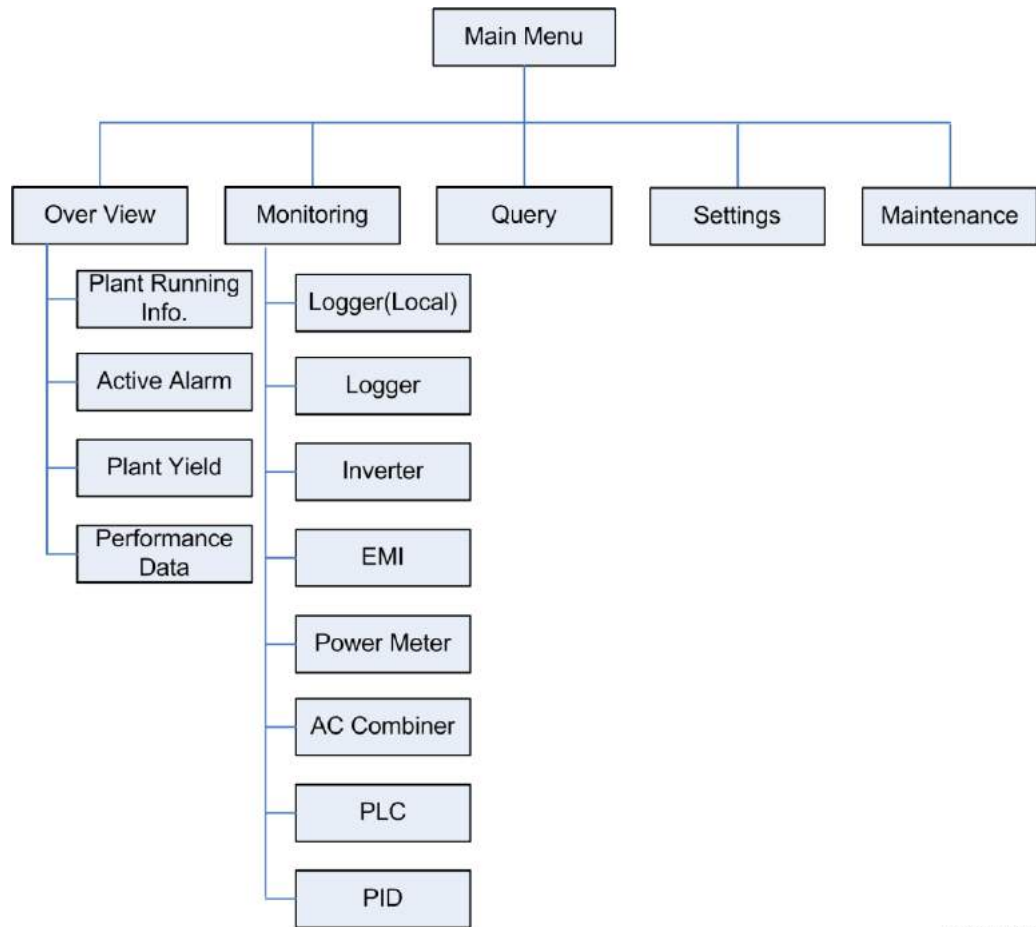

IL01CC0004

Figure 7-14 shows the information available on the **Query** tab page based on user rights.

Figure 7-14 Information available on the Query tab page based on user rights

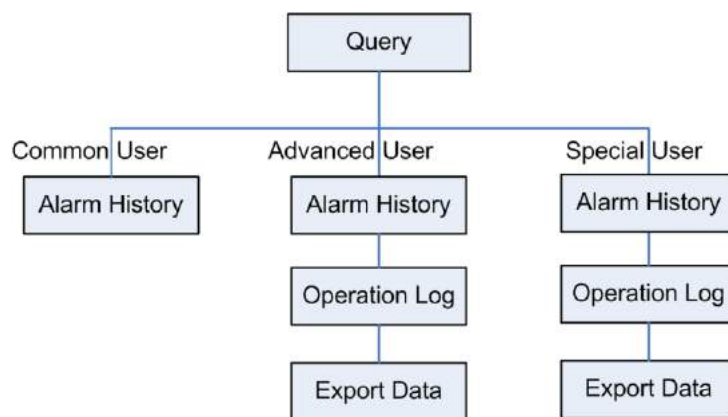

IL01CC0006

Figure 7-15 shows the information available on the **Settings** tab page based on user rights.

Figure 7-15 Information available on the Settings tab page based on user rights

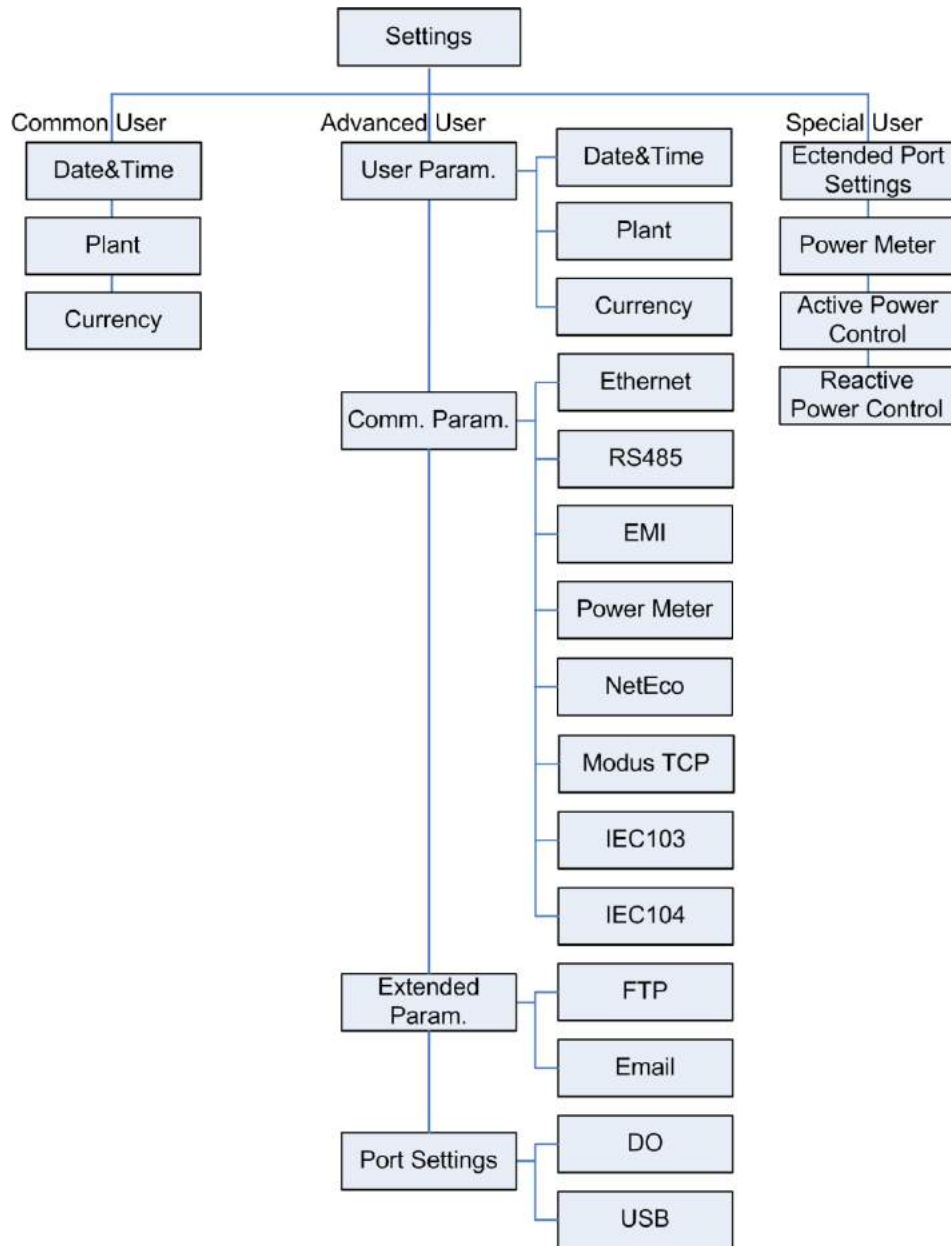

IL01CC0007

Figure 7-16 shows the information available on the **Maintenance** tab page based on user rights.

Figure 7-16 Information available on the Maintenance tab page based on user rights

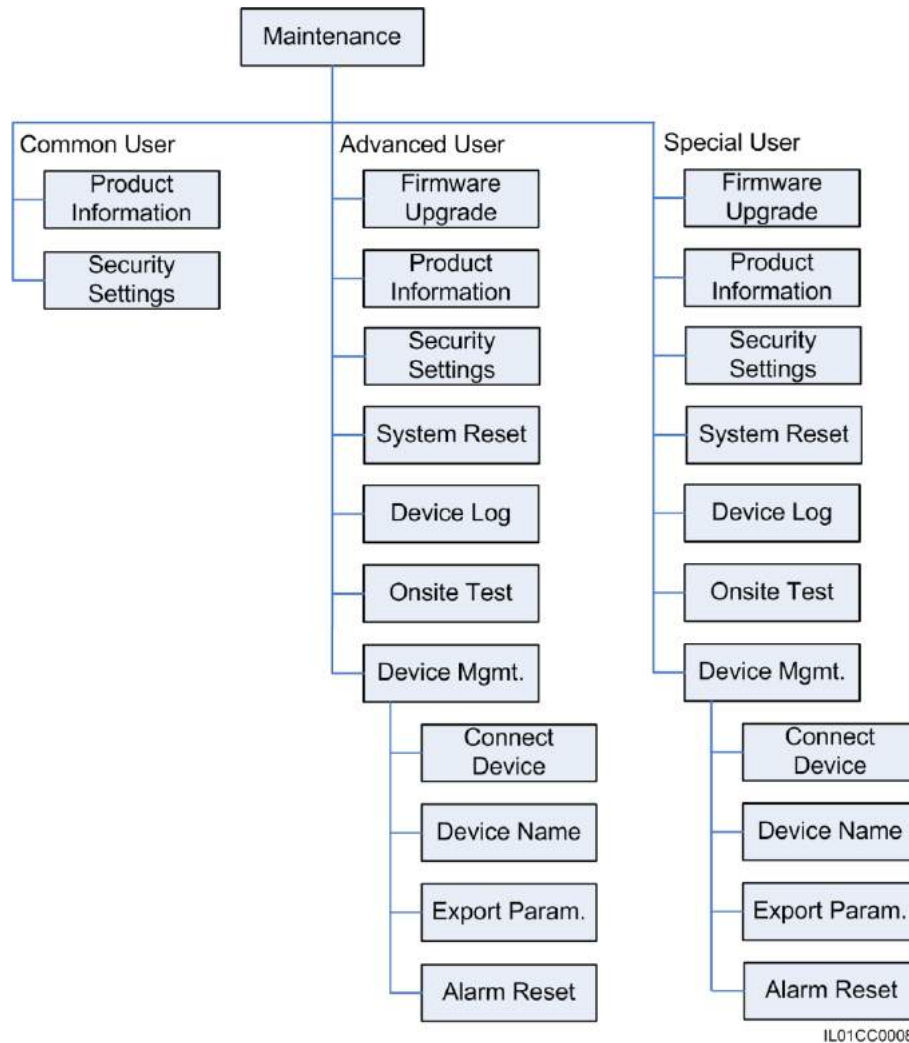

7.5 Querying Running Information of the Power Station

This topic describes how to query the running operation of the power station over the WebUI.

On the **Over View** tab page, select **Plant Running Info.** and query the power station information and energy yield information, as shown in [Figure 7-17](#).

Figure 7-17 Running information of the power station



7.6 Querying Current Active Alarms in the System

This topic describes how to query the current active alarms in the system and details about the alarms over the WebUI.

On the **Over View** tab page, choose **Active Alarm** to access the active-alarm query page. You can query the information about all the current active alarms in the system on this page, including the values of **Alarm ID**, **Severity**, **Equipment**, **Alarm Name**, **Generation Time**, **Reason ID**, and **Cabinet**.

On the **Active Alarm** tab page, choose the equipment to be queried and alarm severity and click **Filter**, as shown in [Figure 7-18](#).

Figure 7-18 Active system alarm

Active Alarm Num:3

Device: All Severity: All Filter

| Alarm ID | Severity | Device | Alarm Name | Generation Time | Reason ID | Cabinet |
|----------|----------|-----------------------|---------------------|---------------------|-----------|---------|
| 301 | Major | SUN2000_8KTL(COM2-18) | Grid Volt. Abnormal | 2013-09-16 11:21:20 | 3 | -- |
| 301 | Major | SUN2000_8KTL(COM2-18) | Grid Volt. Abnormal | 2013-09-16 11:21:20 | 2 | -- |
| 301 | Major | SUN2000_8KTL(COM2-18) | Grid Volt. Abnormal | 2013-09-16 11:21:20 | 1 | -- |

1 / 1 Page Go to

 **NOTE**

You can also quickly determine the severity and quantity of current active alarms by viewing the alarm icons and values in the upper right corner of the WebUI. By clicking a value behind an alarm icon, you can directly access the active system alarm page.

7.7 Querying System Energy Yield

This topic describes how to query system energy yield, including the daily, monthly, annual and historical over the WebUI.

On the **Over View** tab page, click **Plant Yield** and query the system energy yield.

 **NOTE**

When you query system energy yield, select a date from the **Time** drop-down list box or adjust the date by clicking the buttons on both sides of the drop-down list box.

Daily Energy Yield

On the **Day** tab page, set **Time** and click **Query**. The daily and hourly energy yield are displayed, as shown in [Figure 7-19](#).

Figure 7-19 Daily energy yield

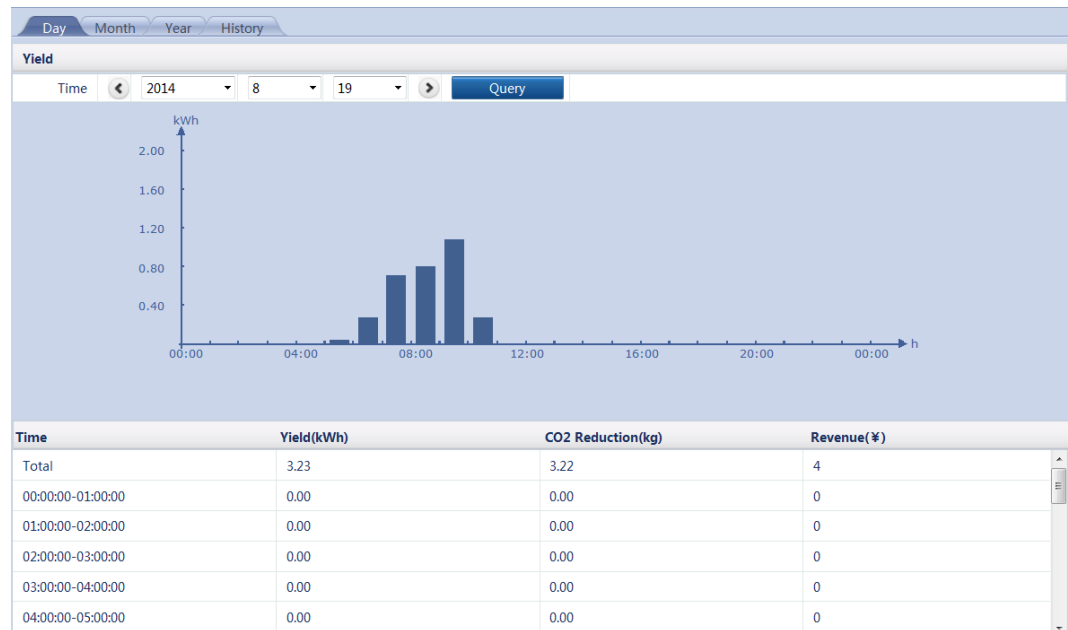

The following information is displayed: energy yield column graph, hourly energy yield, CO₂ emission reduction, revenue, and total values.

NOTE

In the daily energy yield column graph, the horizontal axis indicates time (by hour), and the vertical axis indicates energy yield. Each column indicates the total energy yield within an hour before an integer time point.

On the **Month** tab page, set **Time** and click **Query**. The monthly and daily energy yield are displayed, as shown in [Figure 7-20](#).

Figure 7-20 Monthly energy yield

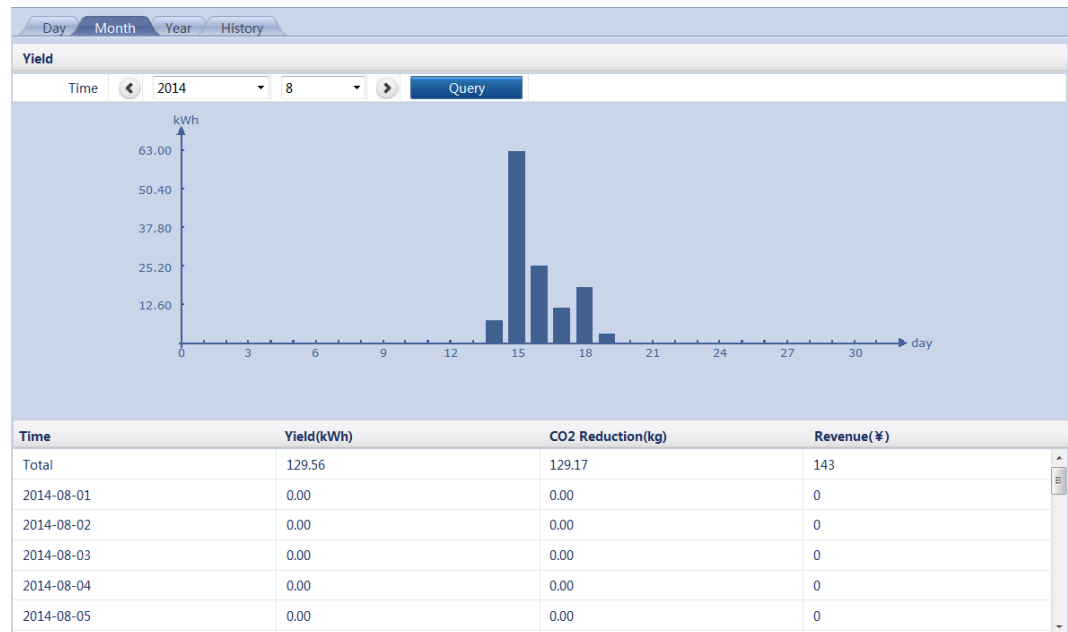

The following information is displayed: energy yield column graph, daily energy yield, CO₂ emission reduction, revenue, and total values.

 **NOTE**

In the monthly energy yield column graph, the horizontal axis indicates time (by day), and the vertical axis indicates energy yield. Each column indicates the total energy yield of a day.

Annual Energy Yield

On the **Year** tab page, set **Time** and click **Query**. The annual and monthly energy yield are displayed, as shown in [Figure 7-21](#).

Figure 7-21 Annual energy yield

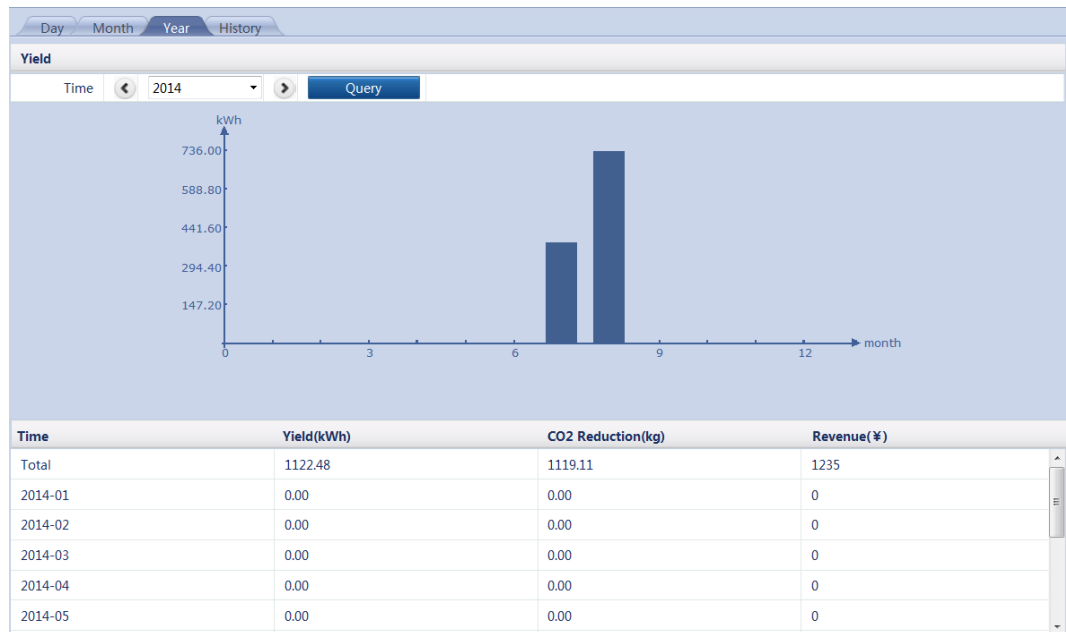

The following information is displayed: energy yield column graph, monthly energy yield, CO₂ emission reduction, revenue, and total values.



NOTE

In the annual energy yield column graph, the horizontal axis indicates time (by month), and the vertical axis indicates energy yield. Each column indicates the total energy yield of a month.

Historical Energy Yield

On the **History** tab page, the total and annual energy yield of the past 25 years are displayed, as shown in [Figure 7-22](#).

Figure 7-22 Historical energy yield



The following information is displayed: energy yield column graph, annual energy yield, CO₂ emission reduction, revenue, and total values.

NOTE

In the historical energy yield column graph, the horizontal axis indicates time (by year), and the vertical axis indicates energy yield. Each column indicates the total energy yield of a year.

7.8 Querying System Performance Data

This topic describes how to query system performance data, display system performance data in a table or curve, and export system performance data over the WebUI.

On the **Over View** tab page, click **Performance Data**. The performance data querying page is displayed.

NOTE

When you query system performance data, select a date from the **Time** drop-down list box or adjust the date by clicking the buttons on both sides of the drop-down list box.

Select **Table**, set **Time**, and click **Query**. You can query the values of various performance parameters, such as **Generation Time**, **Day yield of plant** and **AC Power of plant**, as shown in [Figure 7-24](#).

Figure 7-23 Performance data displayed in a table

| Generation Time | Daily yield of plant(kWh) | Input power of plant(kW) | AC Power of plant(kW) | Radiation(W/m ²) | PV temp.(degC) |
|--------------------|---------------------------|--------------------------|-----------------------|------------------------------|----------------|
| 2013-9-17 12:50:00 | 41.11 | 11.384 | 11.217 | 660.0 | 0.0 |
| 2013-9-17 12:55:00 | 41.81 | 11.062 | 10.964 | 643.0 | 0.0 |
| 2013-9-17 13:00:00 | 42.56 | 2.477 | 2.270 | 154.0 | 0.0 |
| 2013-9-17 13:05:00 | 43.07 | 6.483 | 3.160 | 213.0 | 0.0 |
| 2013-9-17 13:10:00 | 43.89 | 10.766 | 10.833 | 646.0 | 0.0 |
| 2013-9-17 13:15:00 | 44.60 | 10.304 | 11.143 | 636.0 | 0.0 |
| 2013-9-17 13:20:00 | 44.99 | 2.644 | 2.578 | 171.0 | 0.0 |
| 2013-9-17 13:25:00 | 45.78 | 6.286 | 4.106 | 200.0 | 0.0 |
| 2013-9-17 13:30:00 | 46.27 | 9.300 | 9.281 | 598.0 | 0.0 |
| 2013-9-17 13:35:00 | 46.75 | 10.655 | 10.512 | 604.0 | 0.0 |
| 2013-9-17 13:40:00 | 47.49 | 5.572 | 2.584 | 157.0 | 0.0 |
| 2013-9-17 13:45:00 | 48.01 | 2.231 | 2.054 | 136.0 | 0.0 |
| 2013-9-17 13:50:00 | 48.34 | 9.782 | 9.582 | 545.0 | 0.0 |
| 2013-9-17 13:55:00 | 48.98 | 9.578 | 9.556 | 558.0 | 0.0 |

Select **Curve**, set **Time**, **Y1**, and **Y2**, and click **Query**, as shown in [Figure 7-24](#).

Figure 7-24 Performance data displayed in a curve

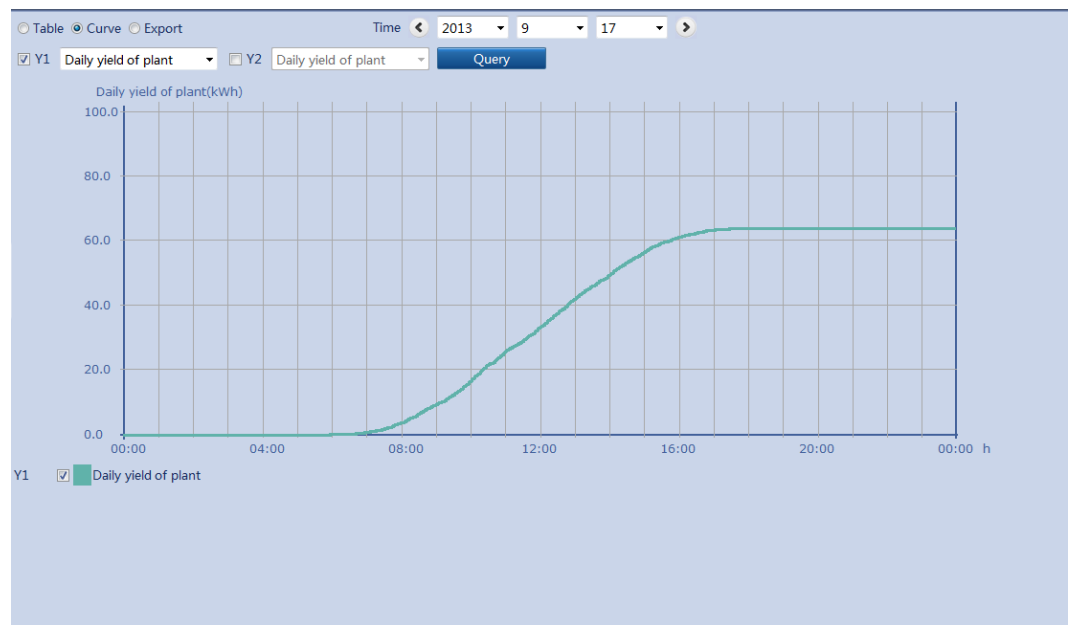

Select **Export** and click **Export**. Performance data is exported, as shown in [Figure 7-25](#).

Figure 7-25 Exporting performance data

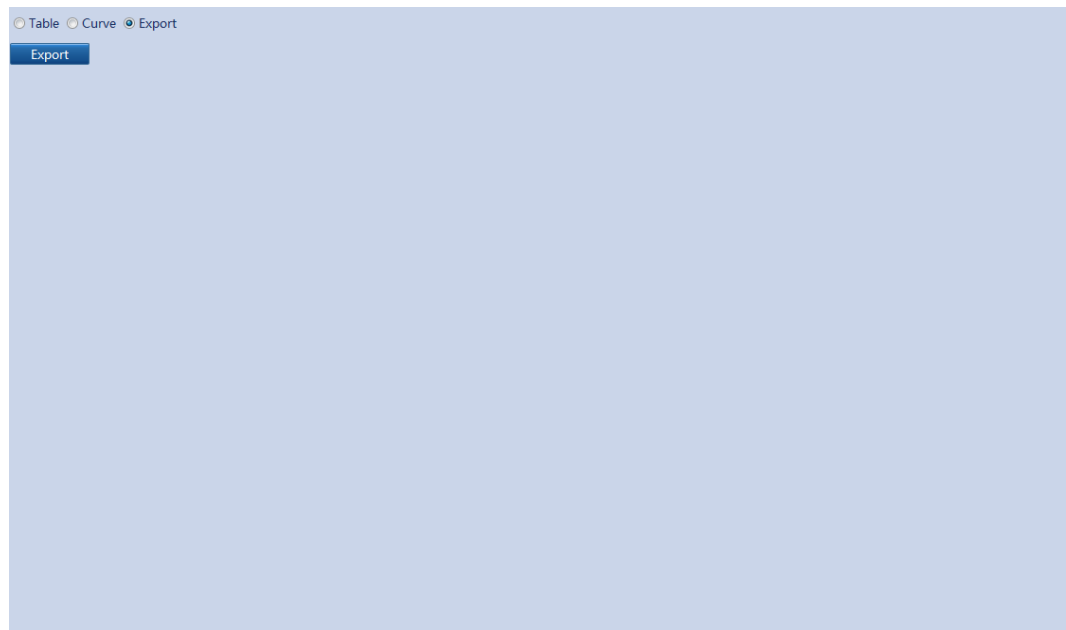

NOTE

When changing the name of the exported files, retain the extension **.tar.gz**. Otherwise, the file cannot be functional.

7.9 Querying Device Running Information

You can query the running information about all inverters connected to the SmartLogger on the WebUI.

On the **Over View** tab page, click **Device Running Info.** to query the device running information, as shown in [Figure 7-26](#).

Figure 7-26 Device running information

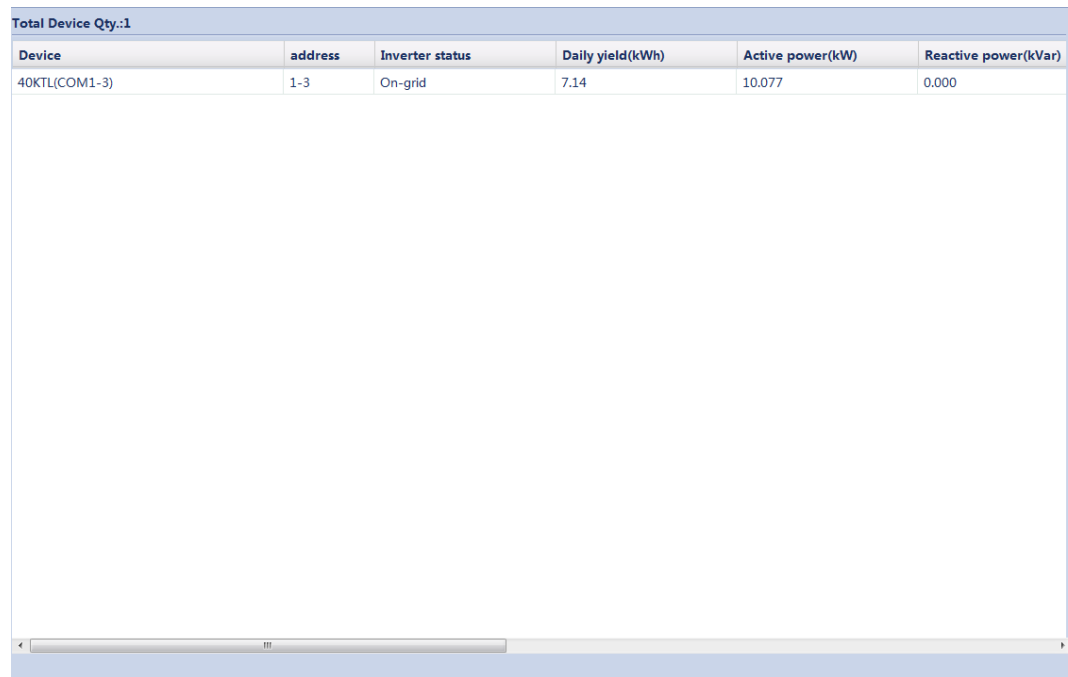

The screenshot displays a table titled "Total Device Qty.:1". The table has six columns: "Device", "address", "Inverter status", "Daily yield(kWh)", "Active power(kW)", and "Reactive power(kVar)". A single row of data is visible, representing a device with ID "40KTL(COM1-3)", address "1-3", inverter status "On-grid", a daily yield of "7.14" kWh, active power of "10.077" kW, and reactive power of "0.000" kVar. The table is presented within a browser window with a scrollbar at the bottom.

| Device | address | Inverter status | Daily yield(kWh) | Active power(kW) | Reactive power(kVar) |
|---------------|---------|-----------------|------------------|------------------|----------------------|
| 40KTL(COM1-3) | 1-3 | On-grid | 7.14 | 10.077 | 0.000 |

7.10 SmartLogger

7.10.1 Querying the Master SmartLogger Running Information

This topic describes how to query the Master SmartLogger running information over the WebUI.

On the **Monitoring** tab page, select a Master SmartLogger, and click **Running Information**. The corresponding **SN**, **Version**, and **IP Address** are displayed, as shown in [Figure 7-27](#).

Figure 7-27 Master SmartLogger running information

| No. | Signal Name | Value | Unit |
|-----|--------------------------------------|-------------------------------|------|
| 1 | SN | 2102310PQW10EB000359 | |
| 2 | Version | V100R001C955PC020 | |
| 3 | Hardware Ver. | C | |
| 4 | IP Address | 10.143.17.248 | |
| 5 | NMS1 IP | NA | |
| 6 | NMS2 IP | NA | |
| 7 | NMS3 IP | 10.63.157.56 | |
| 8 | IEC104 main IP | NA | |
| 9 | IEC104 Sec. IP | NA | |
| 10 | AI1/AI2/AI3/AI4 current | NA/NA/NA/NA | mA |
| 11 | AO1/AO2/AO3/AO4/AO5 feedback current | 0.000/0.000/0.000/0.000/0.000 | mA |
| 12 | DI1/DI2/DI3/DI4(GND1) | 1/0/0/0 | |
| 13 | DI1/DI2/DI3/DI4(GND2) | 0/0/0/1 | |
| 14 | DO1/DO2/DO3 | 0/0/0 | |
| 15 | DC current | 17.3 | A |
| 16 | Input power | 10.216 | kW |
| 17 | Ia | 14 | A |
| 18 | Ib | 14 | A |
| 19 | Ic | 14 | A |
| 20 | Active power | 10.097 | kW |
| 21 | Reactive power | -0.001 | kVar |
| 22 | Power factor | -0.999 | |
| 23 | Inv. efficiency | 98.45 | % |

7.10.2 Querying the Active Alarms of the Master SmartLogger

This topic describes how to query the active alarms of the Master SmartLogger and details about the alarms over the WebUI.

On the **Monitoring** tab page, select the Master SmartLogger to be queried and click **Active Alarm** to access the active-alarm query page. You can query the information about all the active alarms of the selected SmartLogger on this page, including the values of **Alarm ID**, **Severity**, **Alarm Name**, **Generation Time**, **Reason ID**, and **Cabinet**.

On the **Active Alarm** tab page, choose an alarm severity and click **Filter**, as shown in [Figure 7-28](#).

Figure 7-28 Active alarms of the Master SmartLogger

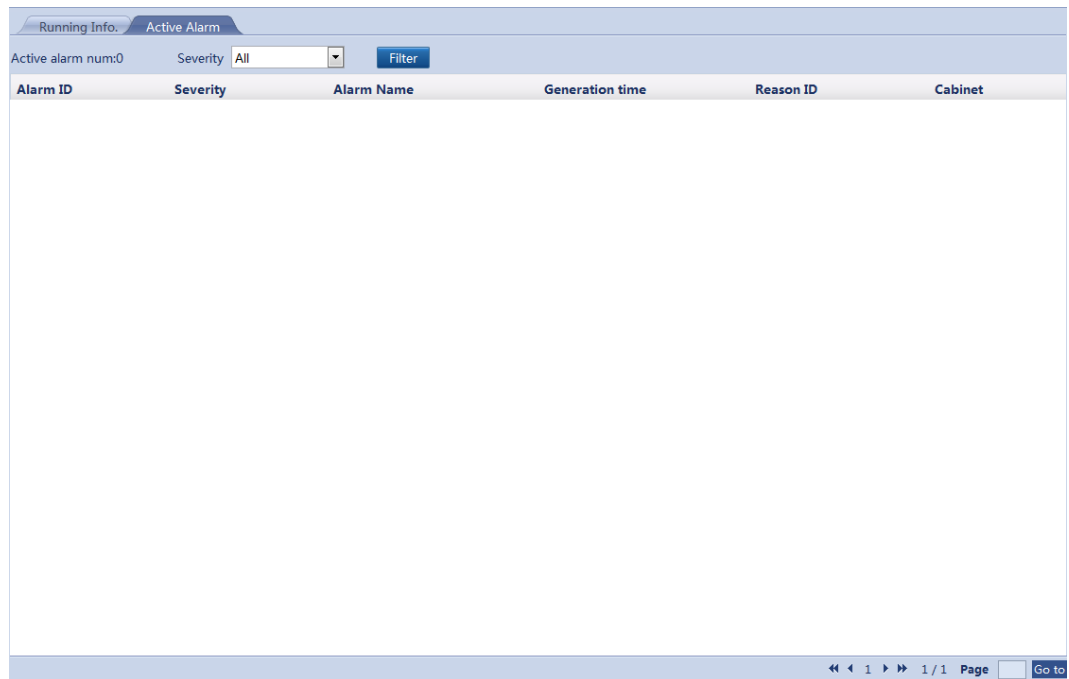

The screenshot displays the 'Active Alarm' section of the SmartLogger1000 WebUI. At the top, there are two tabs: 'Running Info.' and 'Active Alarm'. Below the tabs, the text 'Active alarm num:0' is shown. To the right, there is a 'Severity' dropdown menu set to 'All' and a 'Filter' button. Below this is a table with the following columns: 'Alarm ID', 'Severity', 'Alarm Name', 'Generation time', 'Reason ID', and 'Cabinet'. The table is currently empty. At the bottom right of the interface, there is a page navigation bar with the text '1 / 1 Page' and a 'Go to' button.

7.10.3 Querying Running Information of the Slave SmartLogger

This topic describes how to query the Slave SmartLogger running information over the WebUI.

On the **Monitoring** tab page, select a Slave SmartLogger, and click **Running Information**. The corresponding **SN**, **IP Address**, and **Online Status** are displayed, as shown in [Figure 7-29](#).

Figure 7-29 Slave SmartLogger running information

| Running Info. | | | |
|---------------|---------------|----------------------|------|
| No. | Signal Name | Value | Unit |
| 1 | SN | 2102310PQW10E8000312 | |
| 2 | IP Address | 10.143.17.249 | |
| 3 | Online Status | OnLine | |

7.11 Inverters





7.11.1 Querying Running Information of Inverters

This topic describes how to query running information, including SN, Version, and Devices Status, of inverters over the WebUI.

Querying Device Status

Names and status of devices connected to the SmartLogger are displayed in the left pane of the **Monitoring** tab page.

The indicator in front of the device name indicates the current status of a device.

- When the indicator is , the inverter is in the **On-grid** state, and the EMI, Power Meter, AC Combiner Box, Slave SmartLogger, PLC, PID is in the **Online** state.
- When the indicator is , the inverter, EMI, Power Meter, AC Combiner Box, Slave SmartLogger, PLC, PID is in the **Disconnection** state.
- When the indicator is , the inverter is in the **Loading** state.
- When the indicator is , the inverter is in a non-on-grid state, for example, **Initializing**, **Shutdown**, or **Idle** state.

Querying Running Information

On the **Monitoring** tab page, select an inverter, and click **Running Information**. **SN**, **Version**, and **Devices Status** are displayed, as shown in [Figure 7-30](#).

Figure 7-30 Running information of an inverter

| No. | Signal Name | Value | Unit |
|-----|---------------------------------|-----------------------------------|------|
| 1 | SN | 210107136110D4002015 | |
| 2 | Version | V200R001C00SPC100 | |
| 3 | Port number | 1 | |
| 4 | Physical addr. | 3 | |
| 5 | Logical addr. | 10 | |
| 6 | Inverter status | On-grid | |
| 7 | Inverter rated power | 36 | kW |
| 8 | E-Day | 3.26 | kWh |
| 9 | E-Total | 3153.38 | kWh |
| 10 | CO2 Reduction | 3143.91 | kg |
| 11 | Input power | 10.242 | kW |
| 12 | Active power | 10.084 | kW |
| 13 | Reactive power | 0.000 | kVar |
| 14 | PF | 1.000 | |
| 15 | PV1/PV2/PV3/PV4/PV5/PV6 voltage | 595.7/595.7/206.7/206.7/67.7/67.7 | V |
| 16 | PV1/PV2/PV3/PV4/PV5/PV6 current | 12.7/4.4/0.0/0.0/0.0/0.0 | A |
| 17 | Uab/Ubc/Uca | 390.8/394.1/392.4 | V |
| 18 | Ia/Ib/Ic | 14.8/14.8/14.8 | A |
| 19 | Frequency | 50.01 | Hz |
| 20 | Cabinet temp. | 53.4 | degC |
| 21 | Power-on time | 2015-07-14 10:52:41 | |
| 22 | Power-off time | NA | |
| 23 | DSP data collection status | Normal | |

7.11.2 Manually Powering On or Off the Inverter

This topic describes how to power on or off the inverter over the WebUI.

On the **Monitoring** tab page, choose the inverter to be powered on or off and click **Running Information**. The power-on and power-off buttons are located in the upper right corner of the tab page. The green one is the power-on button and the red one is the power-off button, as shown in [Figure 7-31](#).

Figure 7-31 Manually powering on or off the inverter



 **NOTE**

- When you click the power-on or power-off button, the system displays a prompt asking whether to power on or off the inverter. If you are sure, click **OK**.
- You can also power on or off inverters in batches using the WebUI. For details, see **Batch Power-On/Off** in [7.42.1 Connecting a Device](#).

7.11.3 Querying the Active Alarms of an Inverter

This topic describes how to query the active alarms of an inverter and details about the alarms over the WebUI.

On the **Monitoring** tab page, choose the inverter to be queried and click **Active Alarm** to access the active-alarm query page. You can query the information about all the current active alarms of the selected inverter on this page, including the values of **Alarm ID**, **Severity**, **Alarm Name**, **Generation Time**, **Reason ID**, and **Cabinet**.

On the **Active Alarm** tab page, choose an alarm severity and click **Filter**, as shown in [Figure 7-32](#).

Figure 7-32 Active alarms of the inverter

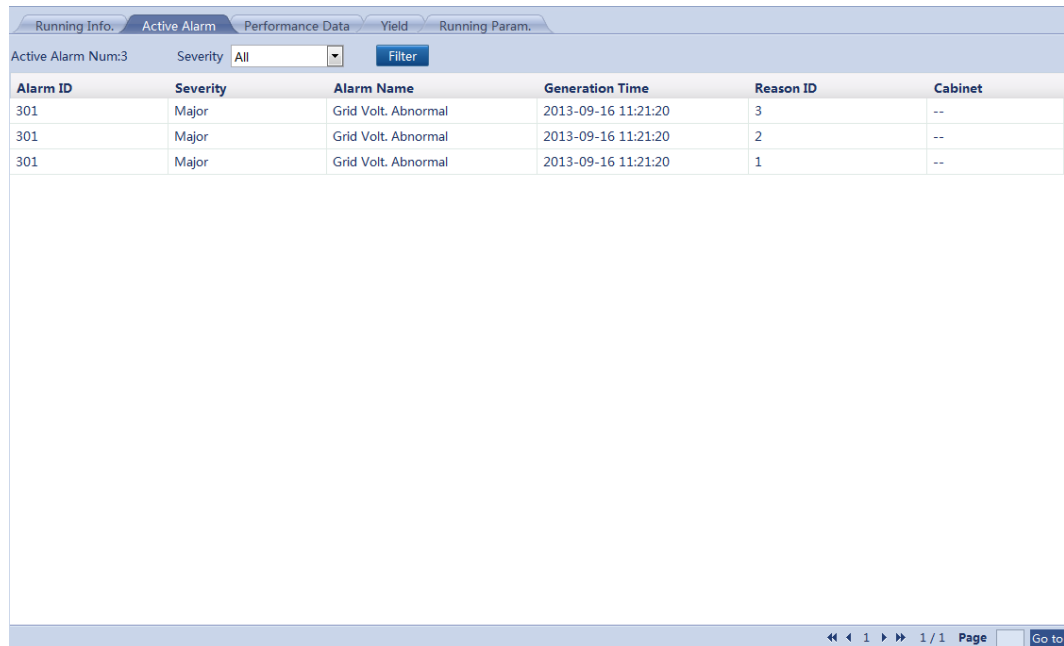

| Alarm ID | Severity | Alarm Name | Generation Time | Reason ID | Cabinet |
|----------|----------|---------------------|---------------------|-----------|---------|
| 301 | Major | Grid Volt. Abnormal | 2013-09-16 11:21:20 | 3 | -- |
| 301 | Major | Grid Volt. Abnormal | 2013-09-16 11:21:20 | 2 | -- |
| 301 | Major | Grid Volt. Abnormal | 2013-09-16 11:21:20 | 1 | -- |

7.11.4 Querying the Performance Data of an Inverter

This topic describes how to query the performance data of an inverter over the WebUI. You can choose to display the performance data in a table or curve or export it.

On the **Monitoring** tab page, choose the inverter to be queried and click **Performance Data** to access the performance data query page.

 **NOTE**

- When querying the performance data of an inverter, you can select a period in which the performance data you want to query directly from the **Time** drop-down list or by clicking the time adjustment buttons on both sides of the drop-down list box.
- Valid performance data of at most one month is stored for each inverter.

Select **Table** as the display mode, select a period in which the performance data you want to query, and click **Query**. You can query the values of various performance parameters, such as **Generation Time**, **Inverter Status**, and **Daily yield**, as shown in [Figure 7-34](#).

Figure 7-33 Performance data displayed in a table

| Generation Time | Inverter Status | Daily yields(kWh) | Input Power(kW) | AC Power(kW) | Reactive Power (kVar) | Power Factor | Frequency(Hz) | PV1 |
|--------------------|-----------------|-------------------|-----------------|--------------|-----------------------|--------------|---------------|-------|
| 2013-9-17 15:10:00 | On-grid | 8.84 | 1.053 | 0.994 | -0.003 | 1.000 | 49.98 | 557.0 |
| 2013-9-17 15:15:00 | On-grid | 8.90 | 0.981 | 0.922 | 0.000 | 1.000 | 50.02 | 555.9 |
| 2013-9-17 15:20:00 | On-grid | 8.95 | 0.986 | 0.925 | 0.001 | 1.000 | 50.02 | 555.1 |
| 2013-9-17 15:25:00 | On-grid | 9.03 | 0.946 | 0.882 | 0.000 | 1.000 | 50.00 | 561.8 |
| 2013-9-17 15:30:00 | On-grid | 9.09 | 0.898 | 0.836 | 0.000 | 1.000 | 50.01 | 555.9 |
| 2013-9-17 15:35:00 | On-grid | 9.14 | 0.857 | 0.796 | 0.000 | 1.000 | 50.01 | 560.7 |
| 2013-9-17 15:40:00 | On-grid | 9.17 | 0.776 | 0.716 | 0.000 | 1.000 | 50.00 | 562.1 |
| 2013-9-17 15:45:00 | On-grid | 9.20 | 0.177 | 0.102 | 0.002 | 1.000 | 49.98 | 549.9 |
| 2013-9-17 15:50:00 | On-grid | 9.25 | 0.717 | 0.654 | 0.000 | 1.000 | 50.01 | 561.9 |
| 2013-9-17 15:55:00 | On-grid | 9.29 | 0.664 | 0.596 | 0.002 | 1.000 | 50.03 | 561.8 |
| 2013-9-17 16:00:00 | On-grid | 9.34 | 0.655 | 0.589 | 0.000 | 1.000 | 50.02 | 560.5 |
| 2013-9-17 16:05:00 | On-grid | 9.39 | 0.580 | 0.511 | -0.001 | 1.000 | 50.01 | 556.3 |
| 2013-9-17 16:10:00 | On-grid | 9.43 | 0.541 | 0.477 | -0.001 | 1.000 | 50.02 | 525.9 |
| 2013-9-17 16:15:00 | On-grid | 9.46 | 0.528 | 0.457 | 0.001 | 1.000 | 49.97 | 513.2 |

Select **Curve** as the display mode, select a period in which the performance data you want to query, specify the parameters indicated by Y1 and Y2, and click **Query**, as shown in [Figure 7-34](#).



NOTICE

You can specify two parameters respectively indicated by Y1 and Y2 simultaneously to compare the value curves of the two parameters. However, the two parameters must be different.

Figure 7-34 Performance data displayed in a curve



You can select **Export** as the display mode and click **Export** to export the performance data, as shown in [Figure 7-35](#).

Figure 7-35 Exporting performance data

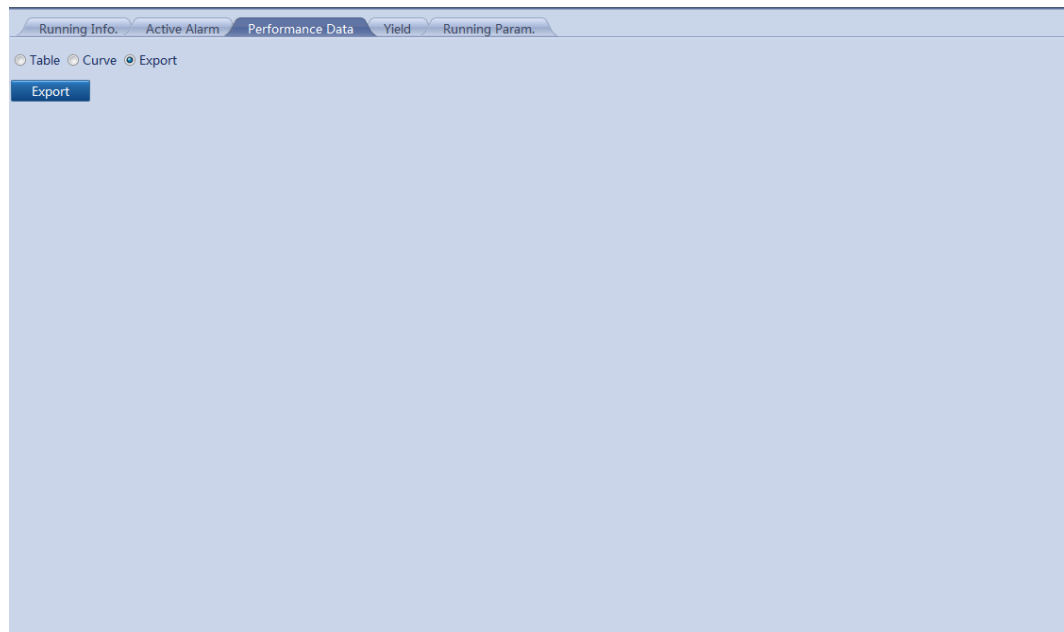

NOTE

When changing the name of the exported files, retain the extension **.tar.gz**. Otherwise, the file cannot be functional.

7.11.5 Querying the Energy Yield of Inverters

This topic describes how to query the energy yield of inverters over the WebUI, including the daily, monthly, annual and historical.

On the **Monitoring** tab page, you can choose the inverter to be queried and click **Yield** to query the information about the energy yield of the inverter.

NOTE

When querying the information about energy yield, you can select a period in which the energy yield you want to query directly from the **Time** drop-down list or by clicking the time adjustment buttons on both sides of the drop-down list box.

Daily Energy Yield of Inverters

On the **Day** tab page, you can select a day and click **Query** to query the total and hourly energy yield of that day, as shown in [Figure 7-36](#).

Figure 7-36 Daily energy yield

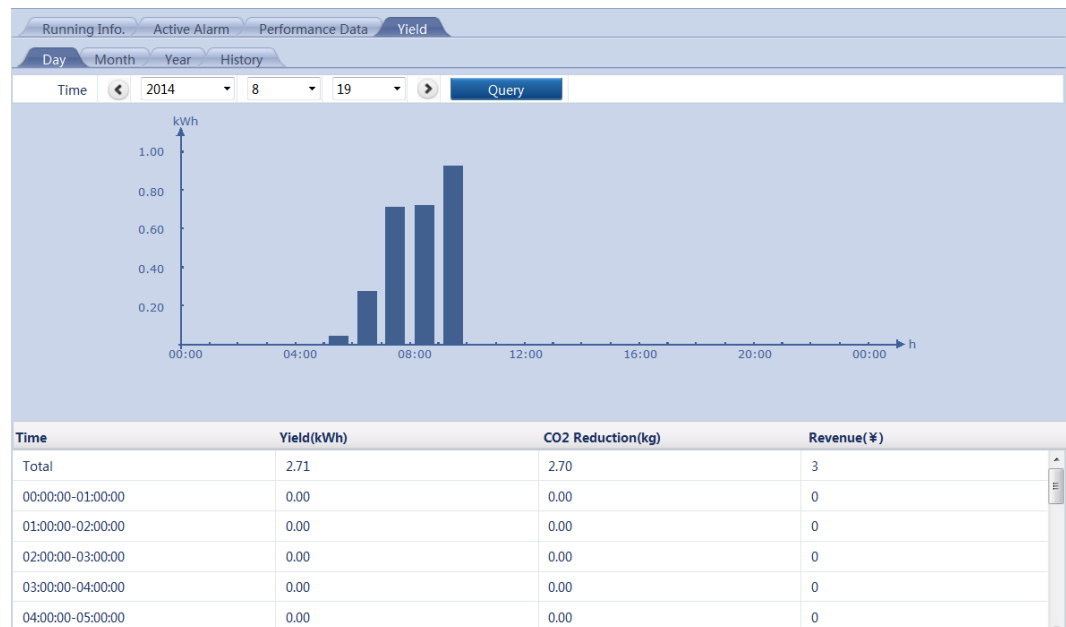

The displayed information includes the energy yield histogram, hourly energy yield, CO₂ emission reduction, revenue corresponding to the emission reduction, and total energy yield, emission reduction, and revenue.

NOTE

In the daily energy yield histogram, the horizontal coordinate stands for time (each block stands for one hour). The vertical coordinate stands for the energy yield (each block stands for the total energy yield during the last hour).

Monthly Energy Yield of Inverters

On the **Month** tab page, you can select a month and click **Query** to query the total and daily energy yield of that month, as shown in [Figure 7-37](#).

Figure 7-37 Monthly energy yield

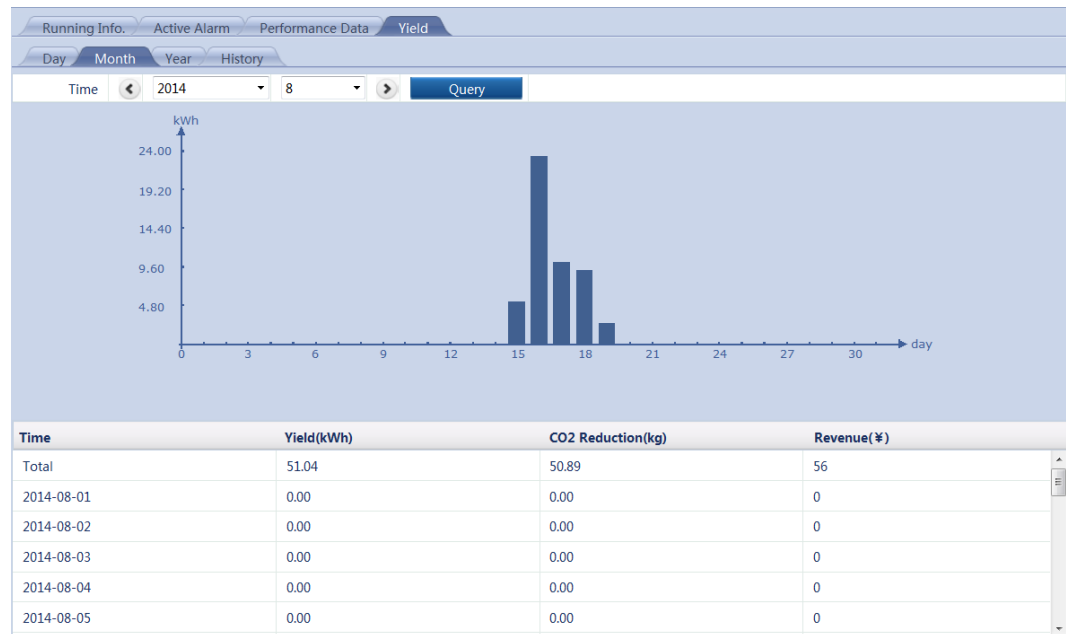

The displayed information includes the energy yield histogram, daily energy yield, CO₂ emission reduction, and revenue.



NOTE

In the monthly energy yield histogram, the horizontal coordinate stands for day (each block stands for one day). The vertical coordinate stands for the energy yield (each block stands for the total energy yield on that day).

Annual Energy Yield of Inverters

On the **Year** tab page, you can select a year and click **Query** to query the total and monthly energy yield of that year, as shown in [Figure 7-38](#).

Figure 7-38 Annual energy yield

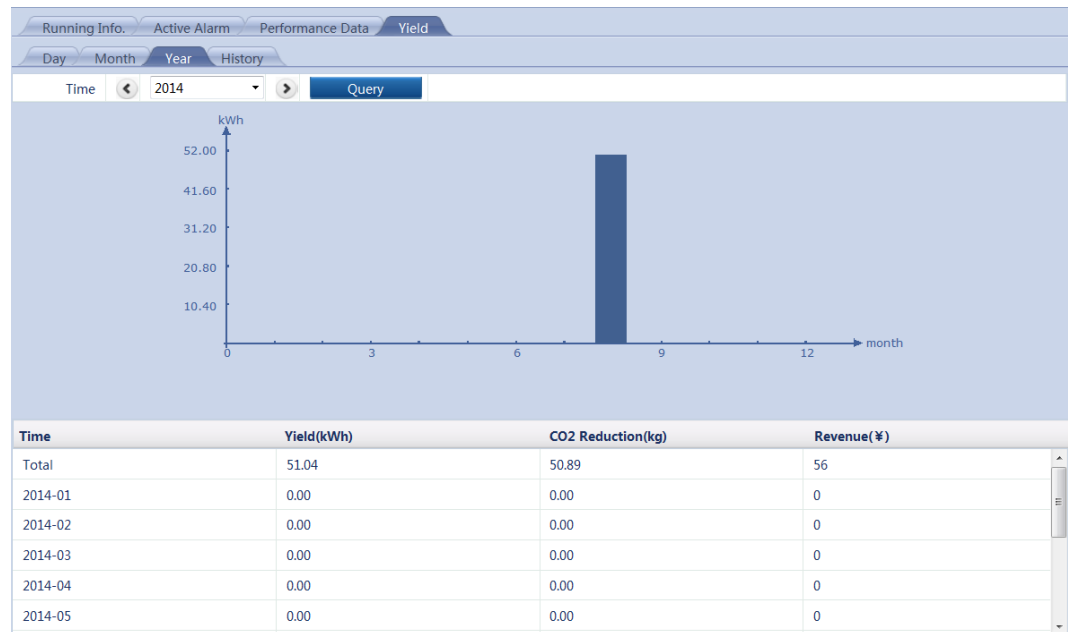

The displayed information includes the energy yield histogram, monthly energy yield, CO₂ emission reduction, and revenue.

NOTE

In the annual energy yield histogram, the horizontal coordinate stands for month (each block stands for one month). The vertical coordinate stands for the energy yield (each block stands for the total energy yield in that month).

Historical Energy Yield of Inverters

On the **History** tab page, you can query the total and annual energy yield of the past 25 years, as shown in [Figure 7-39](#).

Figure 7-39 Historical energy yield



The displayed information includes the energy yield histogram, annual energy yield, CO₂ emission reduction, and revenue.



NOTE

In the historical energy yield histogram, the horizontal coordinate stands for year (each block stands for one year). The vertical coordinate stands for the energy yield (each block stands for the total energy yield in that year).

7.11.6 Setting the Running Parameters of an Inverter

This topic describes how to set the running parameters of an inverter over the WebUI. Due to permission limits, the parameters that can be set by advanced users and special users are different.

On the **Monitoring** tab page, choose the inverter to be set and click **Running Parameter** to access the running parameter setting page. Because of the limited permission, select **User name** as **Advanced User** or **Special User**.



NOTICE

- When the SUN8000 status is **Disconnection**, you cannot set or synchronize parameters.
- You can set or synchronize parameters only when the SUN2000 status is **On-grid** or **Shutdown**.

Running Parameter (1)

When you log in as an **Advanced User**, you can set various parameters, such as **LVRT**, **Anti-Islanding**, **String Monitor**, and **Feed Grid Recovery Time**, as shown in [Figure 7-40](#).

Figure 7-40 Inverter running parameter (1)

| Running Info. Active Alarm Performance Data Yield Running Param. | | | | | |
|--|-----|--|---------------------------|------|--|
| <input type="checkbox"/> All | No. | Signal Name | Value | Unit | |
| <input type="checkbox"/> | 1 | LVRT | Disable | | |
| <input type="checkbox"/> | 2 | Anti-islanding | Disable | | |
| <input type="checkbox"/> | 3 | String monitor | Disable | | |
| <input type="checkbox"/> | 4 | Feed grid recovery time | 10 (10-600) | s | |
| <input type="checkbox"/> | 5 | Isolation | Input ungrounded; with TF | | |
| <input type="checkbox"/> | 6 | Insulation res. protec. | 0.100 (0.033-1.000) | MΩ | |
| <input type="checkbox"/> | 7 | Soft start time | 20 (20-800) | s | |
| <input type="checkbox"/> | 8 | Grid err soft start time | 20 (20-800) | s | |
| <input type="checkbox"/> | 9 | RCD enhancing | Disable | | |
| <input type="checkbox"/> | 10 | K-factor | 2.0 (0.0-3.0) | | |
| <input type="checkbox"/> | 11 | Language | 中文 | | |
| <input type="checkbox"/> | 12 | MPPT multimodal scan enable | Disable | | |
| <input type="checkbox"/> | 13 | SVG | Disable | | |
| <input type="checkbox"/> | 14 | High voltage across the Enable | Disable | | |
| <input type="checkbox"/> | 15 | MPPT scan interval | 15 (5-30) | min | |
| <input type="checkbox"/> | 16 | PV type | Crystalline silicon | | |
| <input type="checkbox"/> | 17 | Crystalline silicon PV PID outp. mode | Output disabled | | |
| <input type="checkbox"/> | 18 | String monitoring low power delay | 180 (2-720) | min | |
| <input type="checkbox"/> | 19 | String monitoring high power delay | 30 (2-720) | min | |
| <input type="checkbox"/> | 20 | String monitoring power segment percentage | 50 (1-100) | % | |
| <input type="checkbox"/> | 21 | String monitoring reference imb. coef. | 20.00 (5.00-100.00) | | |
| <input type="checkbox"/> | 22 | String monitoring start power percentage | 20 (1-100) | % | |
| <input type="checkbox"/> | 23 | Total yield adjusted | 0.00 (0.00-42949600.00) | kWh | |

Submit Synchronize 1 / 1 Page Go to



NOTE

The forced adaptation mode allows inverters to work properly in a harsh power grid environment. If you want to enable this mode, confirm with Huawei technical support first.

Running Parameter (2)

When you log in as a **Special User**, you can set various parameters, such as the protection point and protection time, as shown in [Figure 7-41](#).

Figure 7-41 Inverter running parameter (2)

| Running Info. Active Alarm Performance Data Yield Running Param. Grid Code | | | | | |
|--|-----|-------------------------|--------|-----------------|------|
| <input type="checkbox"/> All | No. | Signal Name | Value | | Unit |
| <input type="checkbox"/> | 1 | Level-1 OV | 552.0 | (480.0-652.8) | V |
| <input type="checkbox"/> | 2 | Level-1 OV protec. time | 2000 | (50-600000) | ms |
| <input type="checkbox"/> | 3 | Level-2 OV | 600.0 | (480.0-652.8) | V |
| <input type="checkbox"/> | 4 | Level-2 OV protec. time | 50 | (50-600000) | ms |
| <input type="checkbox"/> | 5 | Level-1 UV | 320.0 | (144.0-480.0) | V |
| <input type="checkbox"/> | 6 | Level-1 UV protec. time | 2000 | (50-600000) | ms |
| <input type="checkbox"/> | 7 | Level-2 UV | 240.0 | (144.0-480.0) | V |
| <input type="checkbox"/> | 8 | Level-2 UV protec. time | 100 | (50-600000) | ms |
| <input type="checkbox"/> | 9 | Level-1 OF | 50.20 | (50.00-57.50) | Hz |
| <input type="checkbox"/> | 10 | Level-1 OF protec. time | 120000 | (50-600000) | ms |
| <input type="checkbox"/> | 11 | Level-2 OF | 50.50 | (50.00-57.50) | Hz |
| <input type="checkbox"/> | 12 | Level-2 OF protec. time | 200 | (50-600000) | ms |
| <input type="checkbox"/> | 13 | Level-1 UF | 49.50 | (42.50-50.00) | Hz |
| <input type="checkbox"/> | 14 | Level-1 UF protec. time | 600000 | (50-600000) | ms |
| <input type="checkbox"/> | 15 | Level-2 UF | 48.00 | (42.50-50.00) | Hz |
| <input type="checkbox"/> | 16 | Level-2 UF protec. time | 200 | (50-600000) | ms |
| <input type="checkbox"/> | 17 | 10-min OV | 528.0 | (480.00-652.80) | V |
| <input type="checkbox"/> | 18 | 10-min OV protec. time | 200 | (50-600000) | ms |
| <input type="checkbox"/> | 19 | Ugrid imbal. protec. | 50.0 | (0.0-50.0) | % |
| <input type="checkbox"/> | 20 | LVRT threshold | 384.0 | (240.0-432.0) | V |

Submit Synchronize 1 / 1 Page Go to



NOTE

Different parameter configurations on the **Grid Code** tab page correspond to different **Running Parameter** tab pages. Before setting parameters on the **Running Parameter** tab page, set the parameters on the **Grid Code** tab page.

Synchronizing Running Parameters

After setting the running parameters of an inverter, you can click **Synchronize** to synchronize the settings of required parameters to other inverters, as shown in [Figure 7-42](#).

Figure 7-42 Synchronizing running parameters

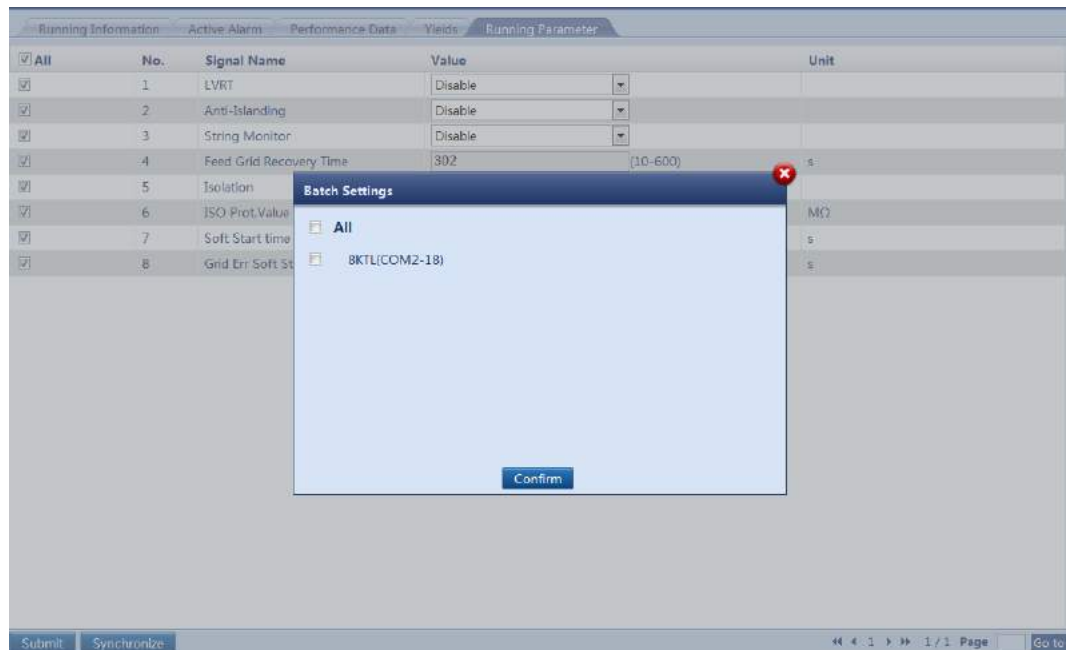

7.11.7 Setting the Power Grid Standard Code for an Inverter

This topic describes how to set the power grid standard code for an inverter over the WebUI.

Setting the Power Grid Standard Code

An inverter can normally generate electricity in grid-tied mode only if the power grid standard code is set properly for it.



NOTICE

This parameter must be set by professional personnel. Otherwise, the equipment may be damaged.

On the **Monitoring** tab page, choose the inverter for which the power grid standard code will be set and click **Grid Code**, as shown in [Figure 7-43](#). Because of the limited permission, select the User name as **Special User**.

Figure 7-43 Power Grid Standard Code

| All | No. | Signal Name | Value |
|--------------------------|-----|-------------|---------------|
| <input type="checkbox"/> | 1 | Grid code | VDE-AR-N-4105 |



NOTICE

Properly set the power grid standard code based on the local standard.

Synchronizing the Power Grid Standard Code

After you set the power grid standard code of one inverter, press **Synchronize** to synchronize the standard code on other inverters, as shown in [Figure 7-44](#).

Figure 7-44 Synchronizing the power grid standard code

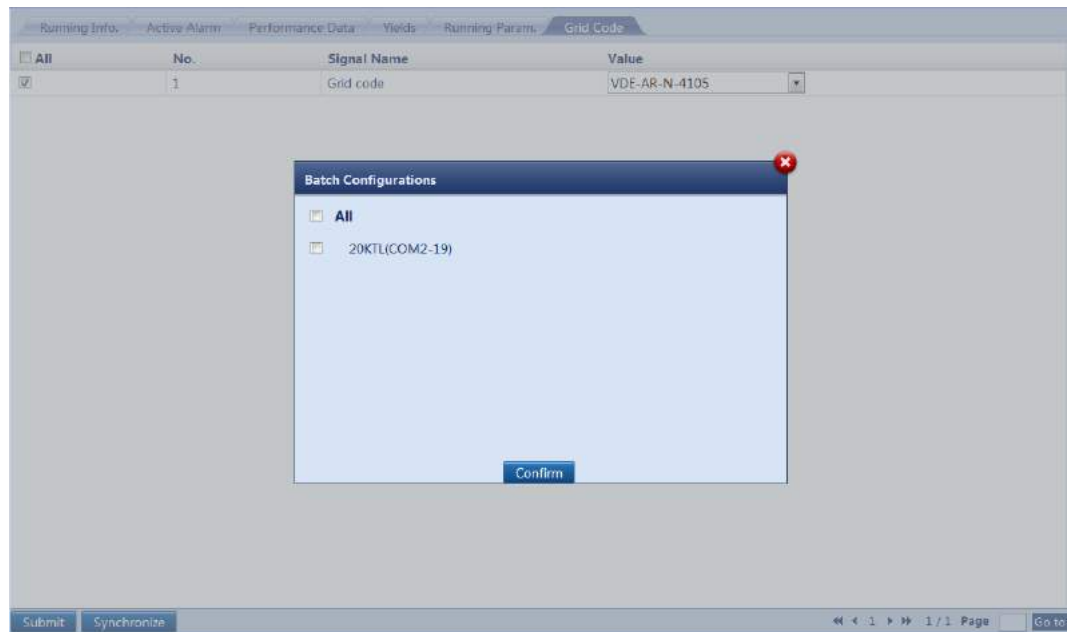

7.12 EMI

7.12.1 Querying the Running Information of an EMI

This topic describes how to query the running information of an environmental monitoring instrument over the WeBUI.

On the **Monitoring** tab page, you can choose the EMI to be queried and click **Running Information** to query the values of various parameters related to the running of the EMI, such as **Total Radiation**, **PV Module Temperature**, **Ambient temperature**, **Wind Speed**, and **Wind Direction**, as shown in [Figure 7-45](#).

Figure 7-45 Running information of the EMI

| Running Info. | | Performance Data | |
|---------------|-----------------|------------------|-------|
| No. | Signal Name | Value | Unit |
| 1 | Radiation | 344.0 | W/m^2 |
| 2 | PV temp. | 0.0 | degC |
| 3 | Logical address | 17 | |
| 4 | Amb. temp. | 49.9 | degC |
| 5 | WSP | 2.1 | m/s |
| 6 | WD | 45(Northeast) | |

7.12.2 Querying the Performance Data of an EMI

This topic describes how to query the performance data of an environmental monitoring instrument over the WebUI. You can choose to display the performance data in a table or curve or export it.

On the **Monitoring** tab page, choose the EMI to be queried and click **Performance Data** to access the performance data query page.

NOTE

- When querying the performance data of an EMI, you can select a period in which the performance data you want to query directly from the **Time** drop-down list or by clicking the time adjustment buttons on both sides of the drop-down list box.
- EMI performance data can be stored for a month.

Select **Table** as the display mode, select a period in which the performance data you want to query, and click **Query**. You can query the values of various performance parameters, such as **Generation Time**, **Radiation**, **PV temperature**, and **Ambient temperature**, as shown in [Figure 7-47](#).

Figure 7-46 Performance data displayed in a table

The screenshot shows a web interface for 'Performance Data'. At the top, there are tabs for 'Running Info.' and 'Performance Data'. Below the tabs, there are radio buttons for 'Table' (selected), 'Curve', and 'Export'. To the right, there is a 'Time' section with dropdown menus for the year (2015), month (3), and day (10). A 'Query' button is located below the time selection. The main area contains a table with the following data:

| Generation time | Current radiation value(W/m ²) | Daily radiation volume(MJ/m ²) | PV temp.(degC) | Amp. temp.(degC) |
|--------------------|--|--|----------------|------------------|
| 2015-3-10 16:20:00 | 0.0 | 0.000 | 0.0 | 0.0 |
| 2015-3-10 16:25:00 | 0.0 | 0.000 | 0.0 | 0.0 |
| 2015-3-10 16:30:00 | 0.0 | 0.000 | 0.0 | 0.0 |
| 2015-3-10 16:35:00 | 0.0 | 0.000 | 0.0 | 0.0 |
| 2015-3-10 16:40:00 | 0.0 | 0.000 | 0.0 | 0.0 |
| 2015-3-10 16:45:00 | 0.0 | 0.000 | 0.0 | 0.0 |

At the bottom right of the interface, there is a pagination control showing '1 / 1 Page' and a 'Go to' button.

Select **Curve** as the display mode, select a period in which the performance data you want to query, specify the parameters indicated by Y1 and Y2, and click **Query**, as shown in [Figure 7-47](#).



NOTICE

You can specify two parameters respectively indicated by Y1 and Y2 simultaneously to compare the value curves of the two parameters. However, the two parameters must be different.

Figure 7-47 Performance data displayed in a curve

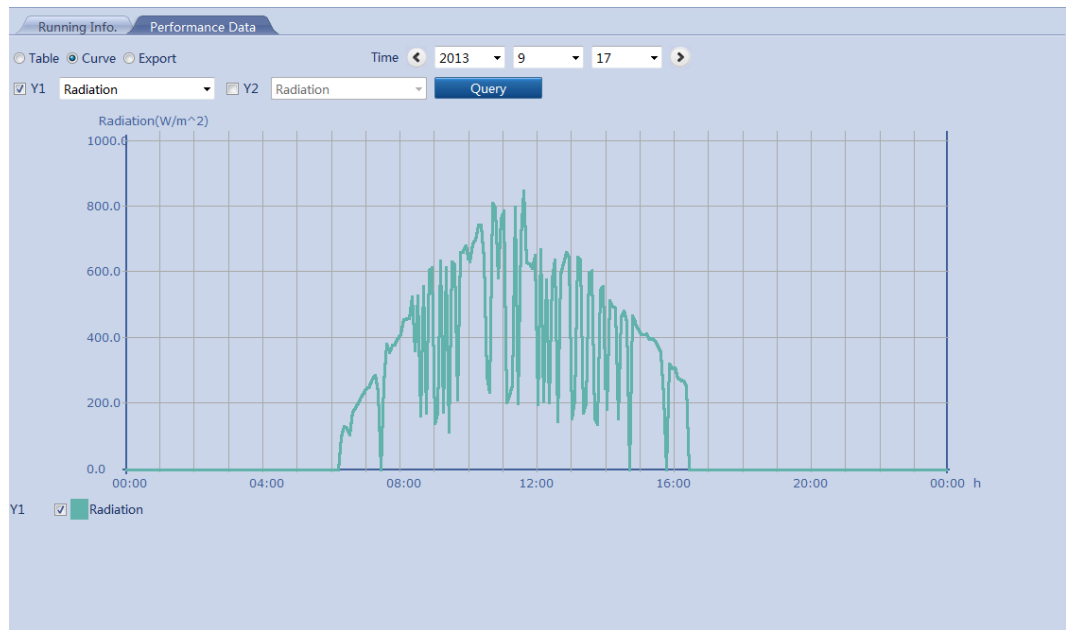

You can select **Export** as the display mode and click **Export** to export the performance data, as shown in [Figure 7-48](#).

Figure 7-48 Exporting performance data

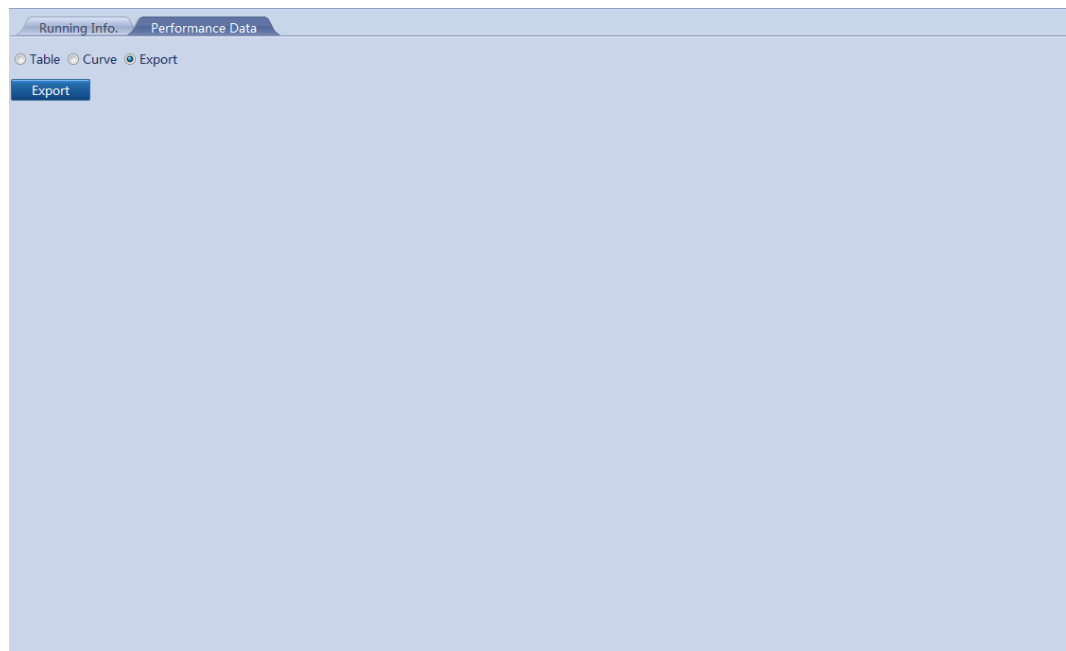

NOTE

When changing the name of the exported files, retain the extension **.tar.gz**. Otherwise, the file cannot be functional.

7.13 Power Meter

7.13.1 Viewing the Power Meter Running Information

This topic describes how to query the power meter running information over the WebUI.

On the **Monitoring** tab page, select an power, and click **Running Information**. The corresponding **Online Status** and **Logical address** are displayed, as shown in [Figure 7-49](#).

Figure 7-49 Power meter running information

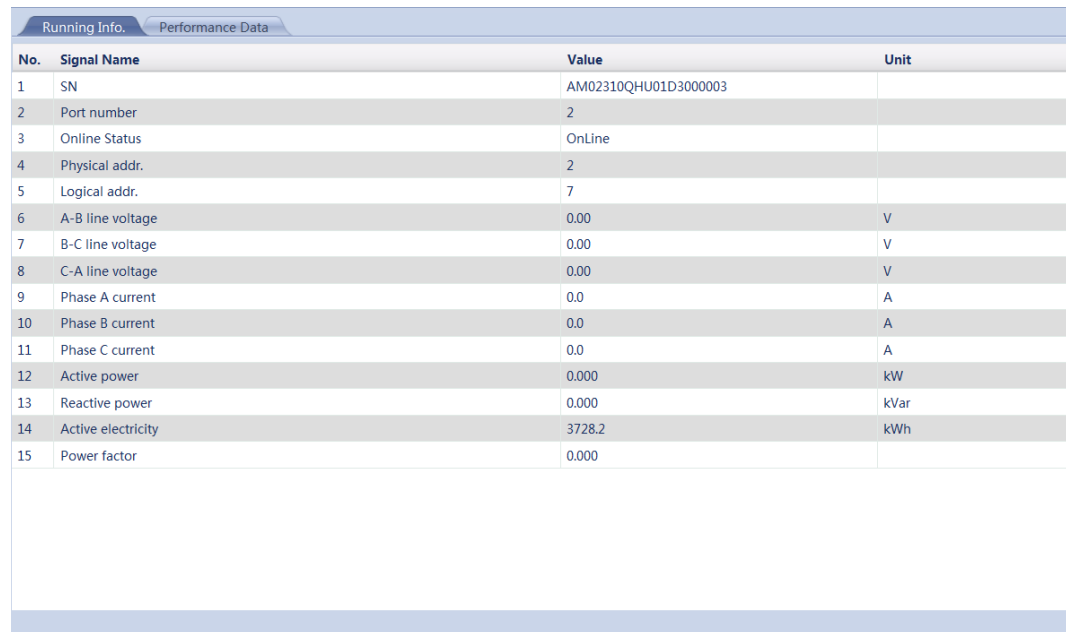

| No. | Signal Name | Value | Unit |
|-----|--------------------|----------------------|------|
| 1 | SN | AM02310QHU01D3000003 | |
| 2 | Port number | 2 | |
| 3 | Online Status | OnLine | |
| 4 | Physical addr. | 2 | |
| 5 | Logical addr. | 7 | |
| 6 | A-B line voltage | 0.00 | V |
| 7 | B-C line voltage | 0.00 | V |
| 8 | C-A line voltage | 0.00 | V |
| 9 | Phase A current | 0.0 | A |
| 10 | Phase B current | 0.0 | A |
| 11 | Phase C current | 0.0 | A |
| 12 | Active power | 0.000 | kW |
| 13 | Reactive power | 0.000 | kVar |
| 14 | Active electricity | 3728.2 | kWh |
| 15 | Power factor | 0.000 | |

7.13.2 Querying the Performance Data of a Power Meter

This topic describes how query the performance data of a power meter over the WebUI. You can choose to display the performance data in a table or curve or export it.

On the **Monitoring** tab page, choose the inverter to be queried and click **Performance Data** to access the performance data query page.

 **NOTE**

When querying the performance data of a power meter, you can select a period in which the performance data you want to query directly from the **Time** drop-down list or by clicking the time adjustment buttons on both sides of the drop-down list box.

Select **Table** as the display mode, select a period in which the performance data you want to query, and click **Query**. You can query the values of various performance parameters, such as **Generation Time**, **Active power**, **Reactive power**, as shown in [Figure 7-50](#).

Figure 7-50 Performance data displayed in a table

| Generation time | Active power(kW) | Reactive power (kVar) | Active electricity (kWh) | Reactive electricity (kVarh) | Apparent power (kVA) | Power factor | Phase Voltage | |
|--------------------|------------------|-----------------------|--------------------------|------------------------------|----------------------|--------------|---------------|------|
| | | | | | | | A | B |
| 2014-8-26 14:50:00 | 0.000 | 0.000 | 3728.2 | 261.0 | 0.000 | 0.000 | 0.00 | 0.00 |
| 2014-8-26 14:55:00 | 0.000 | 0.000 | 3728.2 | 261.0 | 0.000 | 0.000 | 0.00 | 0.00 |
| 2014-8-26 15:00:00 | 0.000 | 0.000 | 3728.2 | 261.0 | 0.000 | 0.000 | 0.00 | 0.00 |

Select **Curve** as the display mode, select a period in which the performance data you want to query, specify the parameters indicated by Y1 and Y2, and click **Query**, as shown in [Figure 7-51](#).



NOTICE

You can specify two parameters respectively indicated by Y1 and Y2 simultaneously to compare the value curves of the two parameters. However, the two parameters must be different.

Figure 7-51 Performance data displayed in a curve

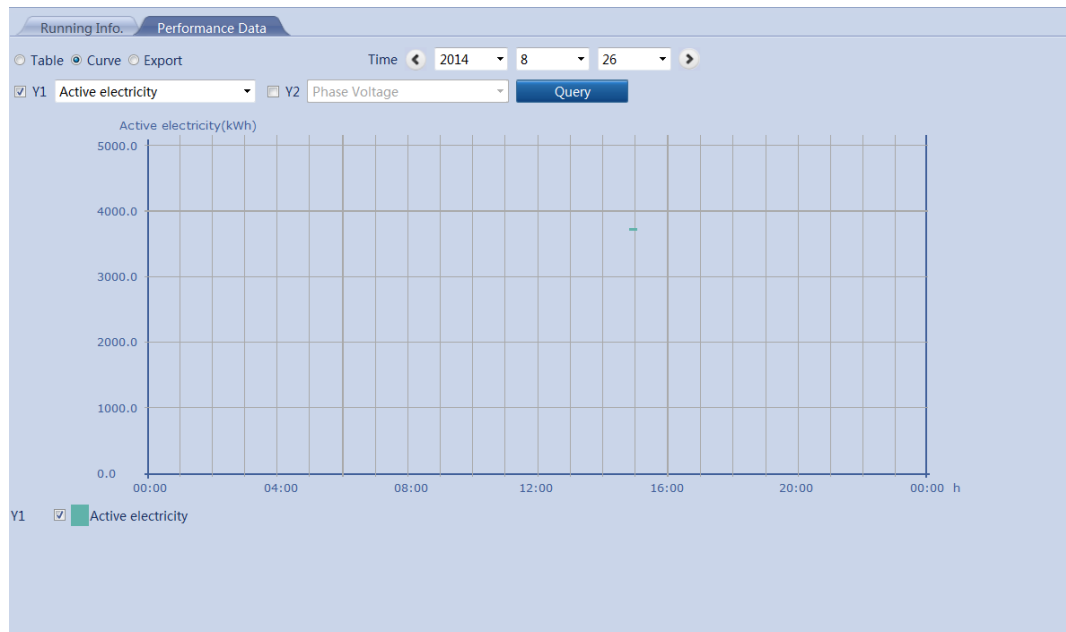

You can select **Export** as the display mode and click **Export** to export the performance data, as shown in [Figure 7-52](#).

Figure 7-52 Exporting performance data

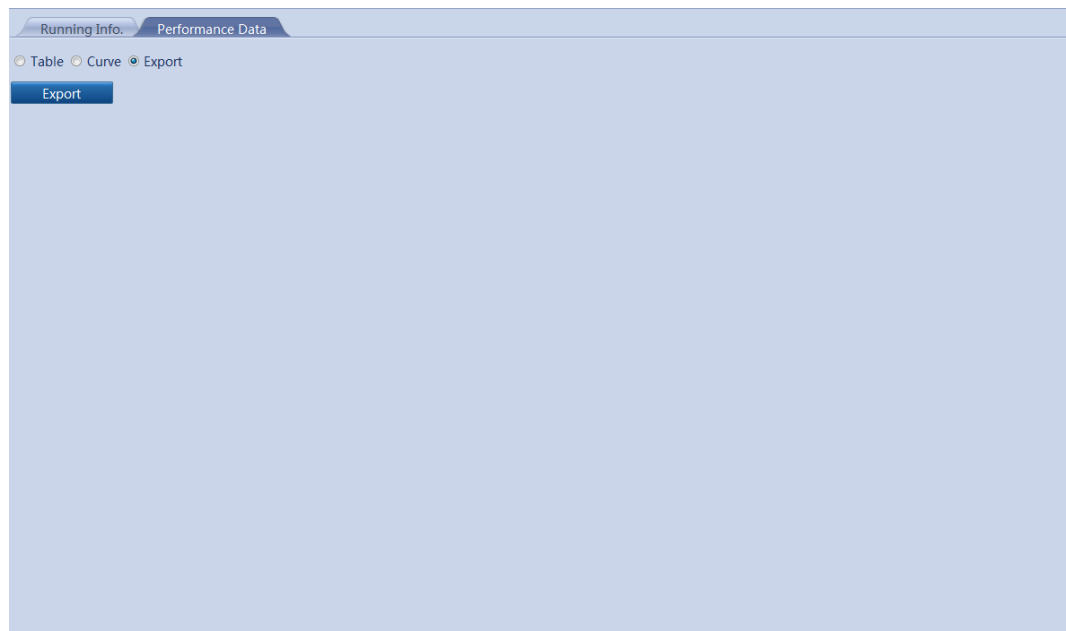

 **NOTE**

When changing the name of the exported files, retain the extension **.tar.gz**. Otherwise, the file cannot be functional.

7.14 AC Combiner Box

7.14.1 Querying Running Information of an AC Combiner Box

This topic describes how to query the running information of an AC combiner box over the WebUI.

On the **Monitoring** tab page, select an AC combiner box, and click **Running Information**. **SN**, **Version**, and **Devices Status** are displayed, as shown in [Figure 7-53](#).

Figure 7-53 Running information of an AC combiner box

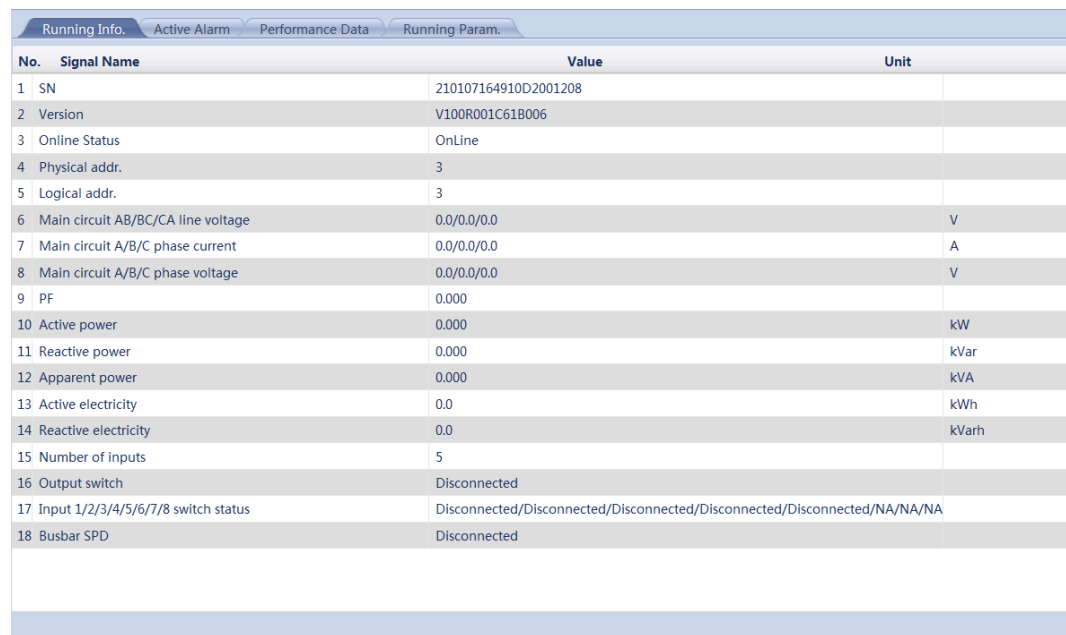

| No. | Signal Name | Value | Unit |
|-----|-------------------------------------|---|-------|
| 1 | SN | 210107164910D2001208 | |
| 2 | Version | V100R001C61B006 | |
| 3 | Online Status | OnLine | |
| 4 | Physical addr. | 3 | |
| 5 | Logical addr. | 3 | |
| 6 | Main circuit AB/BC/CA line voltage | 0.0/0.0/0.0 | V |
| 7 | Main circuit A/B/C phase current | 0.0/0.0/0.0 | A |
| 8 | Main circuit A/B/C phase voltage | 0.0/0.0/0.0 | V |
| 9 | PF | 0.000 | |
| 10 | Active power | 0.000 | kW |
| 11 | Reactive power | 0.000 | kVar |
| 12 | Apparent power | 0.000 | kVA |
| 13 | Active electricity | 0.0 | kWh |
| 14 | Reactive electricity | 0.0 | kVarh |
| 15 | Number of inputs | 5 | |
| 16 | Output switch | Disconnected | |
| 17 | Input 1/2/3/4/5/6/7/8 switch status | Disconnected/Disconnected/Disconnected/Disconnected/Disconnected/NA/NA/NA | |
| 18 | Busbar SPD | Disconnected | |

7.14.2 Querying the Active Alarms of an AC Combiner Box

This topic describes how to query the active alarms of an AC combiner box and details about the alarms over the WebUI.

On the **Monitoring** tab page, choose the AC combiner box to be queried and click **Active Alarm** to access the active-alarm query page. You can query the information about all the current active alarms of the selected inverter on this page, including the values of **Alarm ID**, **Severity**, **Alarm Name**, **Generation Time**, **Reason ID**, and **Cabinet**.

On the **Active Alarm** tab page, choose an alarm severity and click **Filter**, as shown in [Figure 7-54](#).

Figure 7-54 Active alarms of the AC combiner box

| Alarm ID | Severity | Alarm Name | Generation time | Reason ID | Cabinet |
|----------|----------|---------------------|---------------------|-----------|---------|
| 20768 | Minor | Output breaker OFF | 2000-01-01 00:45:17 | 0 | -- |
| 20848 | Minor | SPD alarm | 2000-01-01 00:22:27 | 0 | -- |
| 20773 | Minor | Input 5 breaker OFF | 2000-01-01 00:01:58 | 0 | -- |
| 20772 | Minor | Input 4 breaker OFF | 2000-01-01 00:01:58 | 0 | -- |
| 20771 | Minor | Input 3 breaker OFF | 2000-01-01 00:01:58 | 0 | -- |
| 20770 | Minor | Input 2 breaker OFF | 2000-01-01 00:01:58 | 0 | -- |
| 20769 | Minor | Input 1 breaker OFF | 2000-01-01 00:01:58 | 0 | -- |

7.14.3 Querying the Performance Data of an AC Combiner Box

This topic describes how query the performance data of an AC combiner box over the WebUI. You can choose to display the performance data in a table or curve or export it.

On the **Monitoring** tab page, choose the inverter to be queried and click **Performance Data** to access the performance data query page.

 **NOTE**

When querying the performance data of an AC combiner box, you can select a period in which the performance data you want to query directly from the **Time** drop-down list or by clicking the time adjustment buttons on both sides of the drop-down list box.

Select **Table** as the display mode, select a period in which the performance data you want to query, and click **Query**. You can query the values of various performance parameters, such as **Generation Time**, **Active power**, **Reactive power**, as shown in [Figure 7-55](#).

Figure 7-55 Performance data displayed in a table

| Generation Time | Daily yield of plant(kWh) | Input power of plant(kW) | AC Power of plant(kW) | Radiation(W/m^2) | PV temp.(degC) |
|--------------------|---------------------------|--------------------------|-----------------------|------------------|----------------|
| 2013-9-17 12:50:00 | 41.11 | 11.384 | 11.217 | 660.0 | 0.0 |
| 2013-9-17 12:55:00 | 41.81 | 11.062 | 10.964 | 643.0 | 0.0 |
| 2013-9-17 13:00:00 | 42.56 | 2.477 | 2.270 | 154.0 | 0.0 |
| 2013-9-17 13:05:00 | 43.07 | 6.483 | 3.160 | 213.0 | 0.0 |
| 2013-9-17 13:10:00 | 43.89 | 10.766 | 10.833 | 646.0 | 0.0 |
| 2013-9-17 13:15:00 | 44.60 | 10.304 | 11.143 | 636.0 | 0.0 |
| 2013-9-17 13:20:00 | 44.99 | 2.644 | 2.578 | 171.0 | 0.0 |
| 2013-9-17 13:25:00 | 45.78 | 6.286 | 4.106 | 200.0 | 0.0 |
| 2013-9-17 13:30:00 | 46.27 | 9.300 | 9.281 | 598.0 | 0.0 |
| 2013-9-17 13:35:00 | 46.75 | 10.655 | 10.512 | 604.0 | 0.0 |
| 2013-9-17 13:40:00 | 47.49 | 5.572 | 2.584 | 157.0 | 0.0 |
| 2013-9-17 13:45:00 | 48.01 | 2.231 | 2.054 | 136.0 | 0.0 |
| 2013-9-17 13:50:00 | 48.34 | 9.782 | 9.582 | 545.0 | 0.0 |
| 2013-9-17 13:55:00 | 48.98 | 9.578 | 9.556 | 558.0 | 0.0 |

Select **Curve** as the display mode, select a period in which the performance data you want to query, specify the parameters indicated by Y1 and Y2, and click **Query**, as shown in [Figure 7-56](#).

Figure 7-56 Performance data displayed in a curve

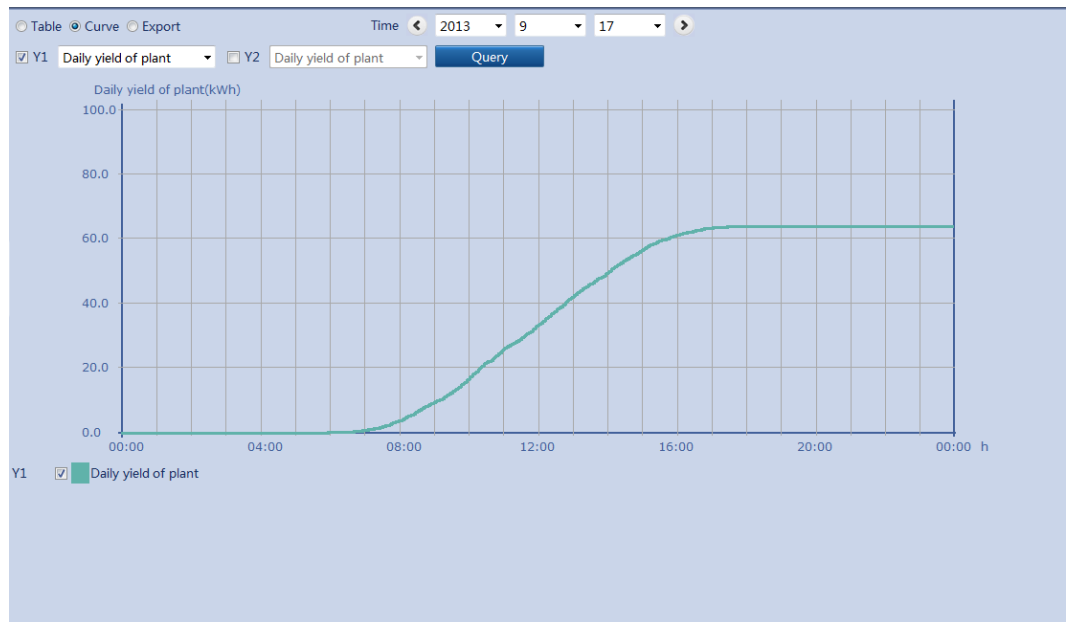

You can select **Export** as the display mode and click **Export** to export the performance data, as shown in [Figure 7-57](#).

Figure 7-57 Exporting performance data

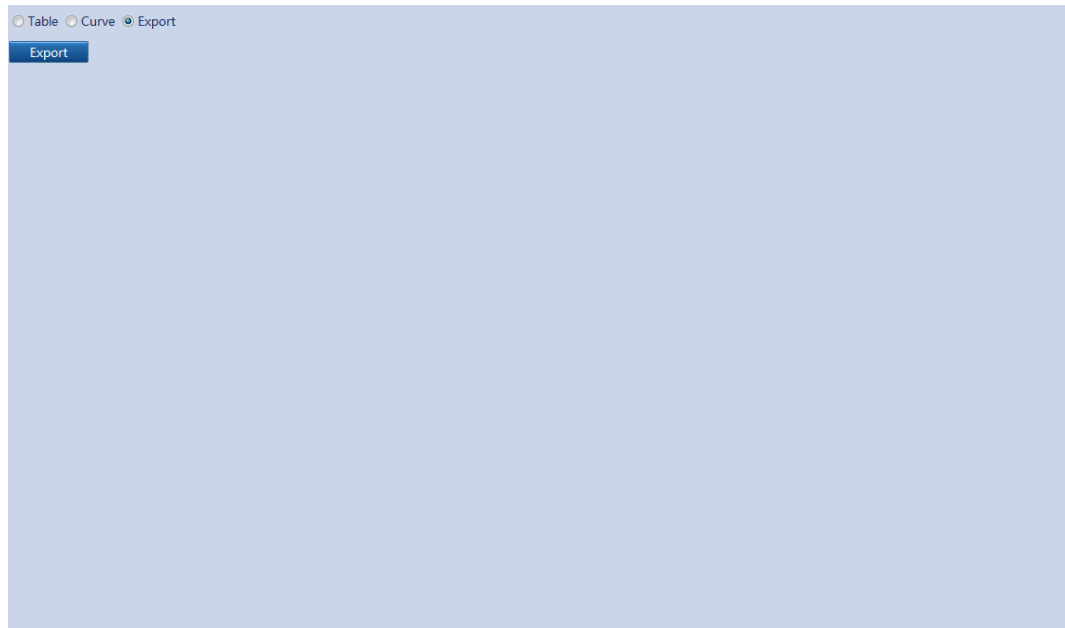

NOTE

When changing the name of the exported files, retain the extension **.tar.gz**. Otherwise, the file cannot be functional.

7.14.4 Setting Running Parameters for an AC Combiner Box

This topic describes how to set running parameters for an AC combiner box over the WebUI.

On the **Monitoring** tab page, choose the AC combiner box to be set and click **Running Info..** The page for setting running parameters is displayed, as shown in [Figure 7-58](#). Because of the limited permission, select **User name** as **Advanced User**.



NOTICE

You cannot set or synchronize running parameters for an AC combiner box in **Disconnection** state.

Figure 7-58 Setting running parameters

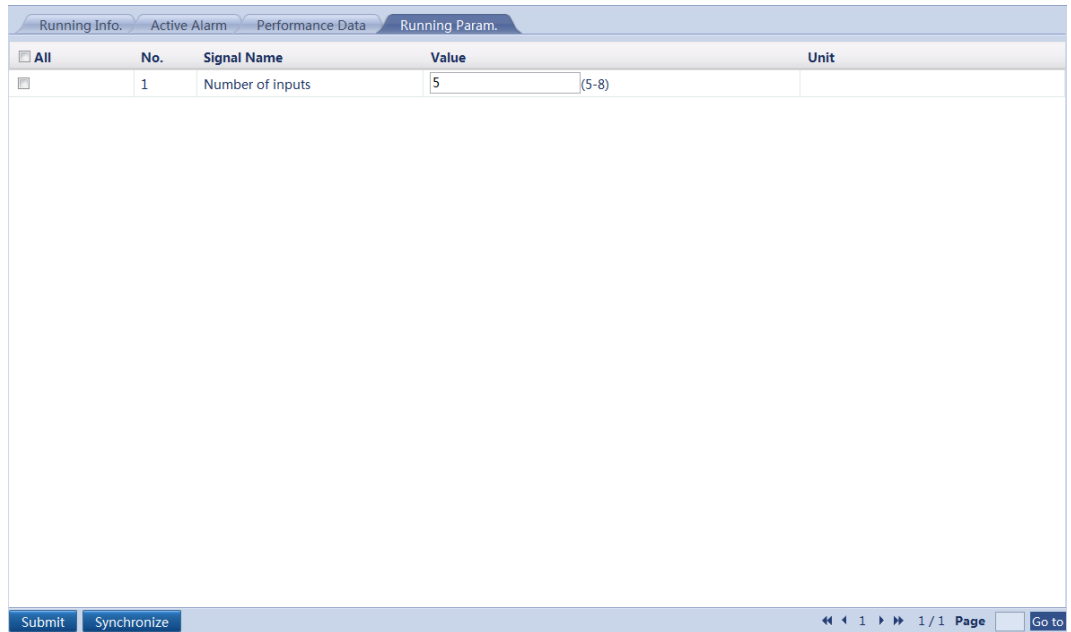

Synchronizing Running Parameters

After you finish setting running parameters for an AC combiner box, you can click **Synchronize** to synchronize the required parameters to other AC combiner boxes, as shown in [Figure 7-59](#).

Figure 7-59 Synchronizing running parameters

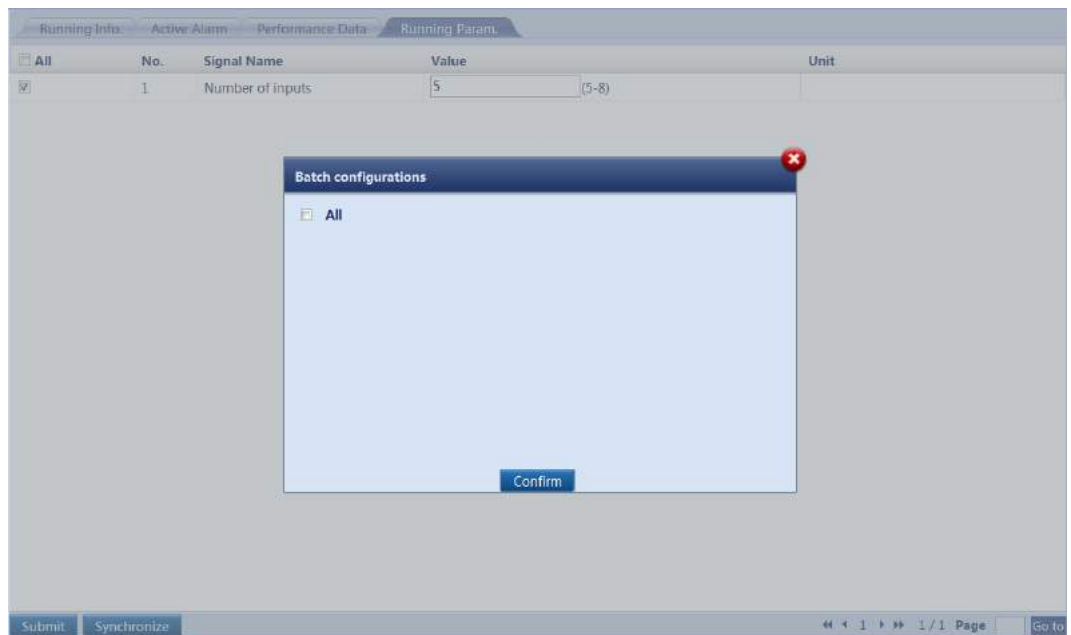

7.15 PLC

7.15.1 Querying the Running Information of a PLC

This topic describes how to query the running information of a PLC over the WebUI.

On the **Monitoring** tab page, you can choose the PLC to be queried and click **Running Info.** to query the values of various parameters related to the running of the PLC, such as **SN**, **Firmware Version**, and **Port number**, as shown in [Figure 7-60](#).

Figure 7-60 Running information of the PLC

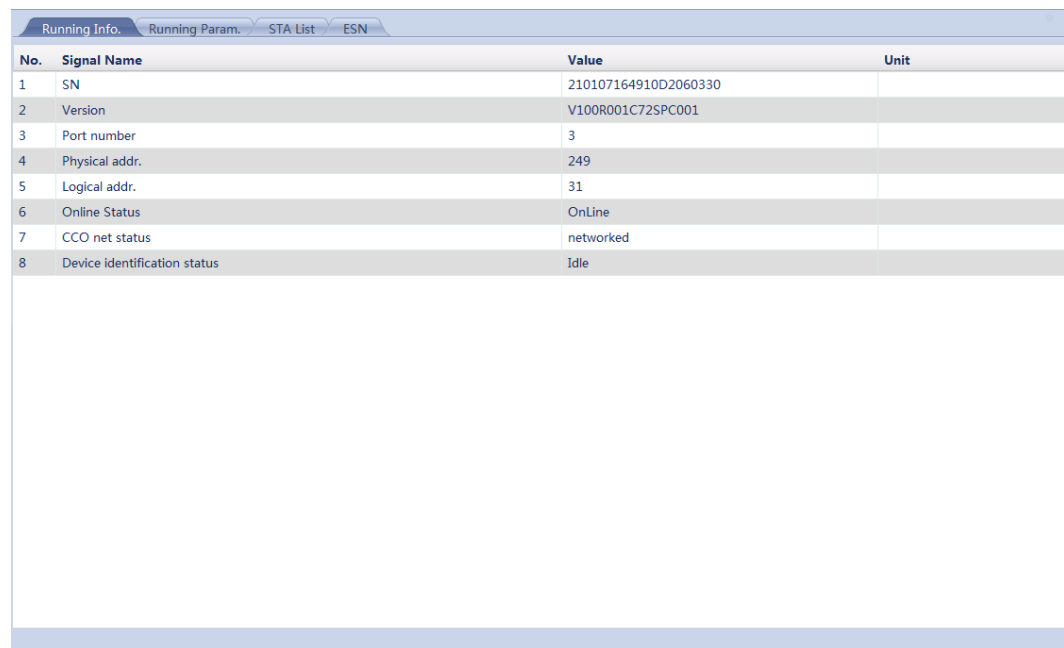

| No. | Signal Name | Value | Unit |
|-----|------------------------------|----------------------|------|
| 1 | SN | 210107164910D2060330 | |
| 2 | Version | V100R001C725PC001 | |
| 3 | Port number | 3 | |
| 4 | Physical addr. | 249 | |
| 5 | Logical addr. | 31 | |
| 6 | Online Status | OnLine | |
| 7 | CCO net status | networked | |
| 8 | Device identification status | Idle | |

7.15.2 Setting Running Parameters for a PLC

This topic describes how to set running parameters for a PLC over the WebUI.

On the **Monitoring** tab page, choose the PLC to be set and click **Running Param.**. The page for setting running parameters is displayed, as shown in [Figure 7-61](#). Because of the limited permission, select **User name** as **Advanced User**.



NOTICE

You cannot set or synchronize running parameters for a PLC in **Disconnection** state.

Figure 7-61 Setting running parameters

| <input type="checkbox"/> All | No. | Signal Name | Value | Unit |
|------------------------------|-----|------------------------|---------|------|
| <input type="checkbox"/> | 1 | Baud rate | 115200 | |
| <input type="checkbox"/> | 2 | Anti-crosstalk enabled | Enable | |
| <input type="checkbox"/> | 3 | Device search start | Disable | |
| <input type="checkbox"/> | 4 | PLC restart | restart | |

7.15.3 Setting the PLC STA List

You can set the PLC STA list on the WebUI.

On the **Monitoring** tab, select **PLC** and click **STA List**. Then you can configure the **Baud rate** and **Attenuation Param.** for listed devices, as shown in [Figure 7-62](#)

Figure 7-62 STA list

| Total Device Qty.:30 | | | | | | |
|--------------------------|-----|-------------------|----------------|----------------------|---------------|-----------|
| <input type="checkbox"/> | No. | MAC Address | Device | ESN | RS485 Address | Baud rate |
| <input type="checkbox"/> | 1 | 48-62-76-70-fd-ad | 33KTL(COM1-18) | 210707164910D2001447 | 18 | 11520 |
| <input type="checkbox"/> | 2 | 48-62-76-70-fd-7d | 33KTL(COM1-26) | 210707164910D2001439 | 26 | 11520 |
| <input type="checkbox"/> | 3 | 48-62-76-70-fd-b1 | 33KTL(COM1-23) | 210707164910D2001452 | 23 | 11520 |
| <input type="checkbox"/> | 4 | 48-62-76-70-fd-69 | 33KTL(COM1-20) | 210707164910D2001442 | 20 | 11520 |
| <input type="checkbox"/> | 5 | 48-62-76-70-fd-91 | 33KTL(COM1-28) | 210707164910D2001448 | 28 | 11520 |
| <input type="checkbox"/> | 6 | 48-62-76-70-fd-b0 | 33KTL(COM1-16) | 210707164910D2001446 | 16 | 11520 |
| <input type="checkbox"/> | 7 | 48-62-76-70-fd-e1 | 33KTL(COM1-30) | 210707164910D2001450 | 30 | 11520 |
| <input type="checkbox"/> | 8 | 48-62-76-70-fd-92 | 33KTL(COM1-29) | 210707164910D2001451 | 29 | 11520 |
| <input type="checkbox"/> | 9 | 48-62-76-70-fd-da | 33KTL(COM1-17) | 210707164910D2001440 | 17 | 11520 |
| <input type="checkbox"/> | 10 | 48-62-76-70-e9-38 | 33KTL(COM1-19) | 210707164910D2001453 | 19 | 11520 |
| <input type="checkbox"/> | 11 | 48-62-76-70-fd-8a | 33KTL(COM1-15) | 210707164910D2001444 | 15 | 11520 |
| <input type="checkbox"/> | 12 | 48-62-76-70-fd-80 | 33KTL(COM1-27) | 210707164910D2001449 | 27 | 11520 |
| <input type="checkbox"/> | 13 | 48-62-76-70-fd-ac | 33KTL(COM1-21) | 210707164910D2001443 | 21 | 11520 |
| <input type="checkbox"/> | 14 | 48-62-76-70-e9-91 | 33KTL(COM1-24) | 210707164910D2001441 | 24 | 11520 |
| <input type="checkbox"/> | 15 | 34-00-a3-de-15-de | 33KTL(COM3-2) | 01234567890123456785 | 2 | 11520 |
| <input type="checkbox"/> | 16 | 34-00-a3-de-15-e0 | | | 0 | 11520 |
| <input type="checkbox"/> | 17 | 34-00-a3-de-15-b2 | 33KTL(COM3-13) | 01234567890123456779 | 13 | 11520 |
| <input type="checkbox"/> | 18 | 34-00-a3-de-15-d2 | 33KTL(COM1-8) | 210107136110D4000001 | 8 | 11520 |
| <input type="checkbox"/> | 19 | 34-00-a3-de-15-c6 | 33KTL(COM3-3) | 01234567890123456786 | 3 | 11520 |
| <input type="checkbox"/> | 20 | 34-00-a3-de-15-5e | 33KTL(COM3-10) | 01234567890123456783 | 10 | 11520 |
| <input type="checkbox"/> | 21 | 48-62-76-70-fd-84 | 33KTL(COM3-14) | 210707164910D2001445 | 14 | 11520 |



NOTE

You can select **Sync. Baud Rates** or **Sync. Attenuation Param.** to modify baud rates or attenuation rates in batches.

7.15.4 Managing PLC ESNs

You can manage PLC ESNs on the WebUI.

On the **Monitoring** tab page, select the PLC to be managed, click **ESN**, and click **Import** or **Export**, as shown in [Figure 7-63](#).

Figure 7-63 Managing ESNs

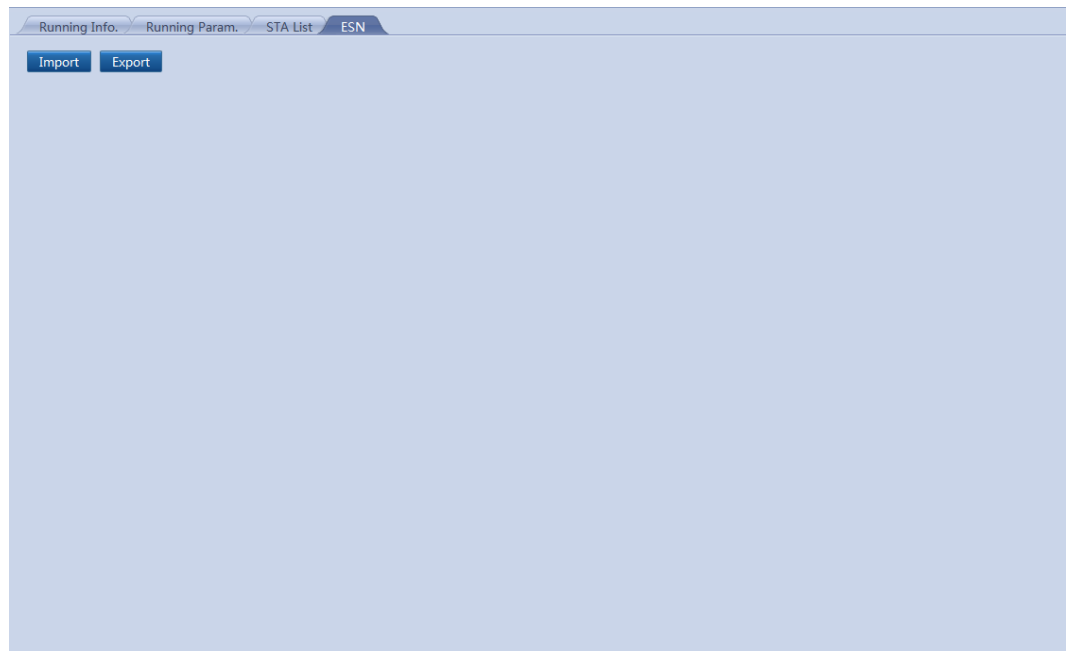

7.16 PID

7.16.1 Querying the Running Information of a PID

This section describes how to query the running information of a PID over the WebUI.

On the **Monitoring** tab, you can choose the PID to be queried and click **Running Info.** to query the values of various parameters related to the running of the PID, such as **SN**, **Firmware Version**, and **Port number**, as shown in [Figure 7-64](#).

Figure 7-64 Running information of the PID

| No. | Signal Name | Value | Unit |
|-----|-------------------|----------------------|------|
| 1 | SN | 021TNR74810000000002 | |
| 2 | Version | V200R1001C00 | |
| 3 | Port number | 3 | |
| 4 | Physical addr. | 2 | |
| 5 | Logical addr. | 3 | |
| 6 | Running status | Running | |
| 7 | Output voltage | 0.0 | V |
| 8 | Output current | 0 | mA |
| 9 | Temperature | 0.0 | degC |
| 10 | PV1 input voltage | 0.0 | V |
| 11 | PV2 input voltage | 0.0 | V |
| 12 | Uab | 0.0 | V |
| 13 | Ubc | 0.0 | V |
| 14 | Uca | 0.0 | V |
| 15 | Grid Frequency | 0.0 | Hz |

7.16.2 Querying the Active Alarms of a PID

This topic describes how to query the active alarms of a PID and details about the alarms over the WebUI.

On the **Monitoring** tab page, choose the PID to be queried and click **Active Alarm** to access the active-alarm query page. You can query the information about all the current active alarms of the selected PID on this page, including the values of **Alarm ID**, **Severity**, **Alarm Name**, **Generation Time**, **Reason ID**, and **Cabinet**.

On the **Active Alarm** tab page, choose an alarm severity and click **Filter**, as shown in [Figure 7-65](#).

Figure 7-65 Active alarms of the PID

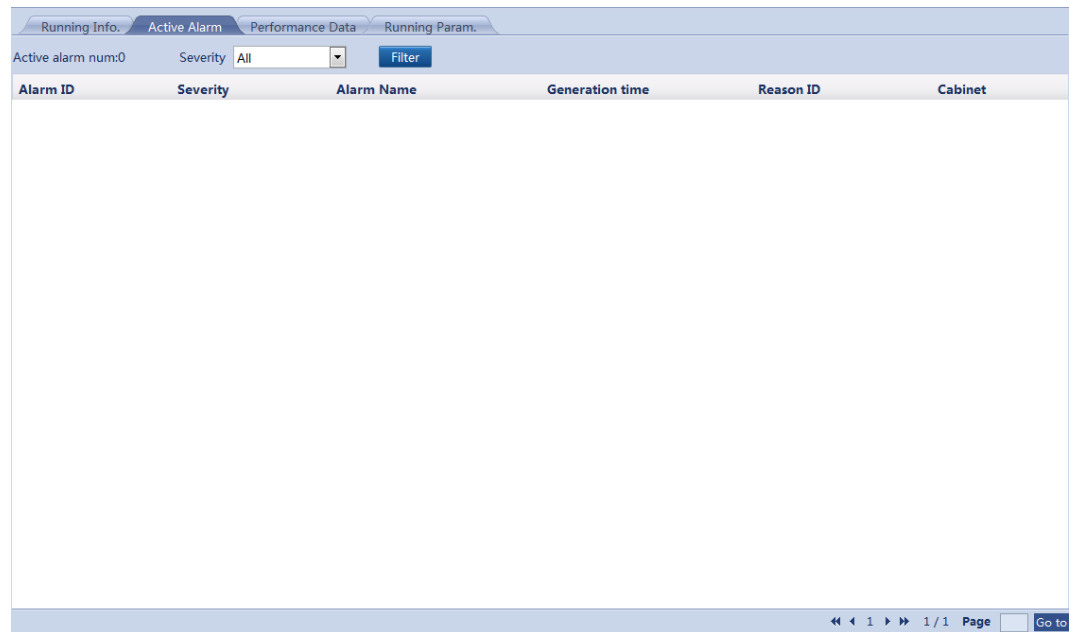

7.16.3 Querying the Performance Data of a PID

This topic describes how to query the performance data of a PID over the WebUI. You can choose to display the performance data in a table or curve or export it.

On the **Monitoring** tab page, choose the PID to be queried and click **Performance Data** to access the performance data query page.

 **NOTE**

When querying the performance data of a PID, you can select a period in which the performance data you want to query directly from the **Time** drop-down list or by clicking the time adjustment buttons on both sides of the drop-down list box.

Select **Table** as the display mode, select a period in which the performance data you want to query, and click **Query**. You can query the values of various performance parameters, such as **Generation Time**, **Output Voltage**, and **Output Current**, as shown in [Figure 7-66](#).

Figure 7-66 Performance data displayed in a table

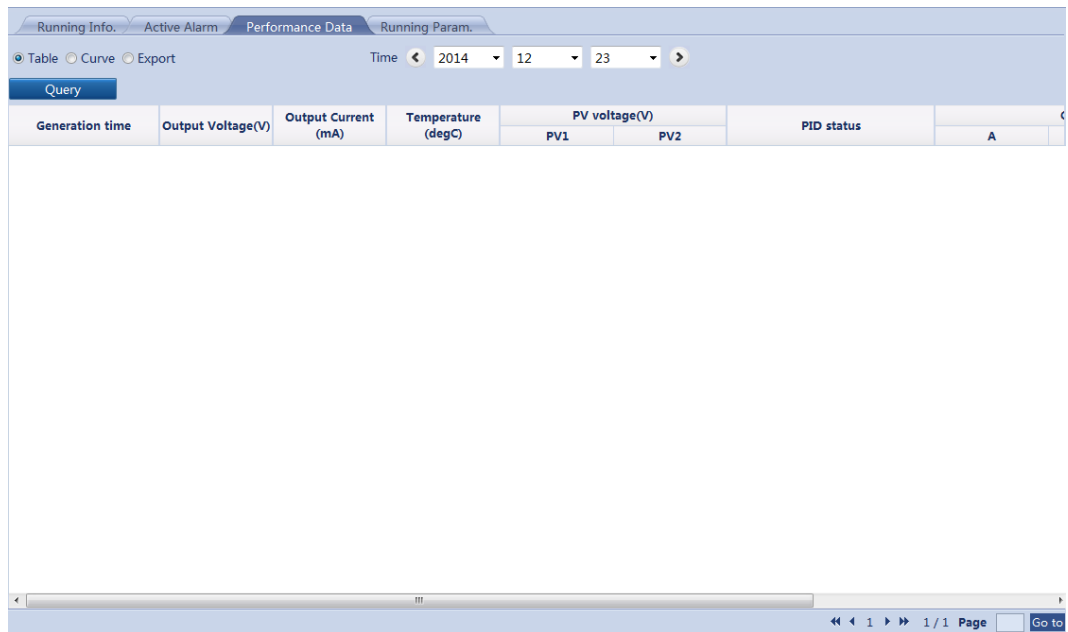

Select **Curve** as the display mode, select a period in which the performance data you want to query, specify the parameters indicated by Y1 and Y2, and click **Query**, as shown in [Figure 7-67](#).

Figure 7-67 Performance data displayed in a curve



You can select **Export** as the display mode and click **Export** to export the performance data, as shown in [Figure 7-68](#).

Figure 7-68 Exporting performance data

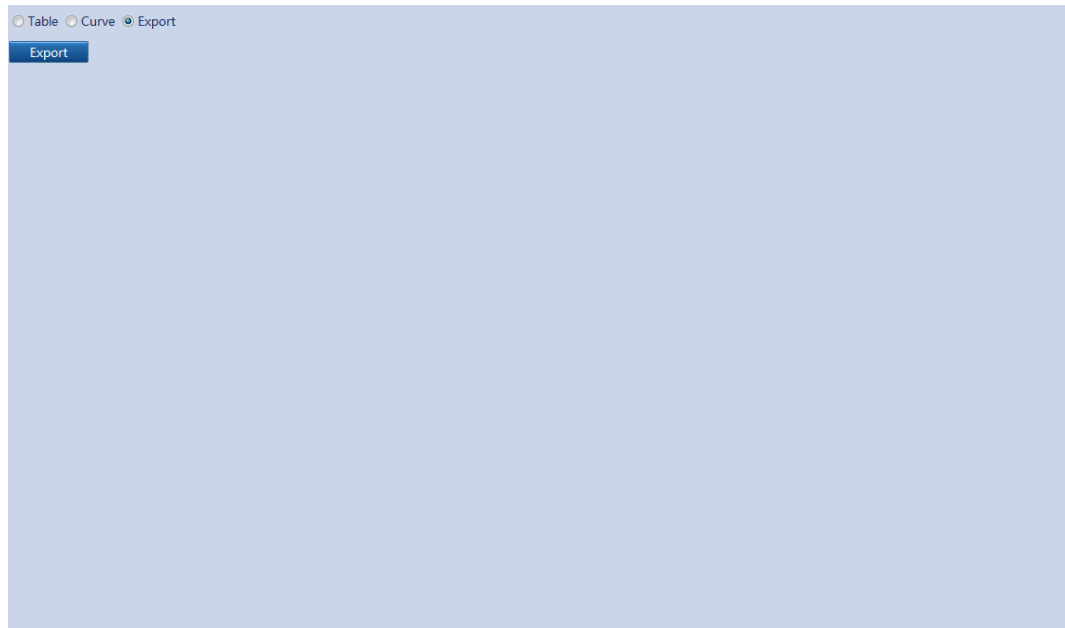

NOTE

When changing the name of the exported files, retain the extension **.tar.gz**. Otherwise, the file cannot be functional.

7.16.4 Setting Running Parameters for a PID

This topic describes how to set running parameters for a PID over the WebUI.

On the **Monitoring** tab page, choose the PID to be set and click **Running Param.** The page for setting running parameters is displayed, as shown in [Figure 7-69](#). Because of the limited permission, select **User name** as **Advanced User**.



NOTE

You cannot set or synchronize running parameters for a PID in **Disconnection** state.

Figure 7-69 Setting running parameters

| <input type="checkbox"/> All | No. | Signal Name | Value | Unit |
|------------------------------|-----|-----------------------|-----------------|------|
| <input type="checkbox"/> | 1 | Control mode | Disabled | |
| <input type="checkbox"/> | 2 | Output enabled | Disable | |
| <input type="checkbox"/> | 3 | PV type | P-type | |
| <input type="checkbox"/> | 4 | Volt. Inject. into PV | 0.0 (0.0-500.0) | V |
| <input type="checkbox"/> | 5 | Operation mode | Normal | |
| <input type="checkbox"/> | 6 | Commission out. volt. | 0.0 (0.0-500.0) | V |
| <input type="checkbox"/> | 7 | Data Clear | Starting | |

7.17 Custom Devices

7.17.1 Querying Running Information of Custom Devices

This topic describes how to query the running information of custom devices over the WeBUI.

On the **Monitoring** tab page, you can choose the PLC to be queried and click **Running Information** to query the values of various parameters related to the running of the custom device, as shown in [Figure 7-70](#).

Figure 7-70 Running information of a custom device

| Running Info. Teleindication Telemetry Telecontrol Teleadjust | | | |
|---|-----------------|----------------------|------|
| No. | Signal Name | Value | Unit |
| 1 | SN | CT1C93164901D2001230 | |
| 2 | Port number | 1 | |
| 3 | Physical addr. | 3 | |
| 4 | Logical address | 4 | |
| 5 | Online Status | Online | |

7.17.2 Querying Teleindication Information

You can query the teleindication information of a custom device on the WebUI.

On the **Monitoring** tab page, select the custom device whose teleindication information needs to be queried and click **Teleindication**, as shown in [Figure 7-71](#).

Figure 7-71 Teleindication information of a custom device

| Running Info. Teleindication Telemetry Telecontrol Teleadjust | | | |
|---|-----------------|-------|------|
| No. | Signal Name | Value | Unit |
| 1 | Locked | 0 | |
| 2 | Inverter status | 0 | |

7.17.3 Querying Telemetry Information

You can query the telemetry information of a custom device on the WebUI.

On the **Monitoring** tab page, select the custom device whose telemetry information needs to be queried and click **Telemetry**, as shown in [Figure 7-72](#).

Figure 7-72 Telemetry information of a custom device

| No. | Signal Name | Value | Unit |
|-----|----------------|-------|------|
| 1 | PV1 voltage | 0.0 | V |
| 2 | PV1 current | 0.0 | A |
| 3 | PV2 voltage | 0.0 | V |
| 4 | PV2 current | 0.0 | A |
| 5 | PV3 voltage | 0.0 | V |
| 6 | PV3 current | 0.0 | A |
| 7 | PV4 voltage | 0.0 | V |
| 8 | PV4 current | 0.0 | A |
| 9 | PV5 voltage | 0.0 | V |
| 10 | PV5 current | 0.0 | A |
| 11 | PV6 voltage | 0.0 | V |
| 12 | PV6 current | 0.0 | A |
| 13 | Active power | 0.000 | kW |
| 14 | Reactive power | 0.000 | kVar |

7.17.4 Setting Telecontrol Parameters

You can set the telecontrol parameters for a custom device on the WebUI.

On the **Monitoring** tab, choose the device to be set and click **Telecontrol**. The page for setting telecontrol parameters is displayed, as shown in [Figure 7-73](#). Because of permission restriction, you must select **User name** as **Advanced User**.



NOTICE

Telecontrol parameters cannot be set for a custom device in the **Disconnection** state.

Figure 7-73 Setting telecontrol parameters

| <input type="checkbox"/> All | No. | Signal Name | Value | Unit |
|------------------------------|-----|-------------|-------|------|
| <input type="checkbox"/> | 1 | Power-on | 0 | |
| <input type="checkbox"/> | 2 | Power-off | 0 | |

7.17.5 Setting Teleadjust Parameters

You can set the teleadjust parameters for a custom device on the WebUI.

On the **Monitoring** tab, choose the device to be set and click **Teleadjust**. The page for setting teleadjust parameters is displayed, as shown in [Figure 7-74](#). Because of permission restriction, you must select **User name** as **Advanced User**.



NOTICE

Teleadjust parameters cannot be set for a custom device in the **Disconnection** state.

Figure 7-74 Setting teleadjust parameters

| <input type="checkbox"/> All | No. | Signal Name | Value | Unit |
|------------------------------|-----|-------------|-------|------|
| <input type="checkbox"/> | 1 | Level-1 OV | 0.0 | V |
| <input type="checkbox"/> | 2 | Level-2 OV | 0.0 | V |

Submit << < 1 > >> 1 / 1 Page Go to

7.18 Querying Historical Alarms

This topic describes how to query historical alarms of the equipment over the WebUI.

On the **Query** tab page, you can select **Alarm History** to query the alarm information of the equipment.

On the **Alarm History** page, choose the equipment to be queried and the start time, end time, and sorting mode of alarms. After that, click **Query**, as shown in [Figure 7-75](#).

Figure 7-75 Historical alarms

The screenshot shows the 'Alarm History' interface. At the top, there are search filters: 'Equipment' set to 'SUN2000_8KTL(COM2-18)', 'Start Time' set to '2013-07-03', and 'End Time' set to '2013-08-06'. The 'Sorting Mode' is set to 'Time'. A 'Query' button is present. Below the filters, it states 'Number of alarms that meet the conditions: 5'. The main part of the interface is a table with the following data:

| No. | Alarm ID | Severity | Equipment | Alarm Name | Generation Time | End Time | Reason ID | Cabinet |
|-----|----------|----------|-----------------------|---------------------|---------------------|---------------------|-----------|---------|
| 1 | 313 | Major | SUN2000_8KTL(COM2-18) | Low Insulation Res. | 2013-07-21 05:21:13 | 2013-07-21 05:51:56 | 1 | -- |
| 2 | 301 | Major | SUN2000_8KTL(COM2-18) | Grid Volt. Abnormal | 2013-07-15 09:27:57 | 2013-07-15 14:09:13 | 29 | -- |
| 3 | 505 | Major | SUN2000_8KTL(COM2-18) | Upgrade failed | 2013-07-12 08:59:08 | 2013-07-12 09:14:51 | 1 | -- |
| 4 | 504 | Minor | SUN2000_8KTL(COM2-18) | Version Mismatch | 2013-07-12 08:59:05 | 2013-07-12 09:14:02 | 1 | -- |
| 5 | 301 | Major | SUN2000_8KTL(COM2-18) | Grid Volt. Abnormal | 2013-07-07 08:34:50 | 2013-07-07 08:41:12 | 29 | -- |

At the bottom right of the table area, there is a pagination control showing '1 / 1 Page' and a 'Go to' button.

7.19 Querying Operation Logs

This topic describes how to query operation logs over the WebUI.

On the **Query** tab page, click **Operation Log**. Operation logs (such as login, parameter setting, data export, firmware upgrade, and password change) of users are displayed, as shown in [Figure 7-76](#). Because of the limited permission, select the User name as **Advanced User** or **Special User**.

Figure 7-76 Operation logs

| Operation Log | | | | |
|--|---------------|---------------------|------------------|---|
| Number of alarms that meet the conditions : 1000 | | | | |
| No. | User Name | Operation Time | Operation Source | Content |
| 1 | Advanced User | 2013-12-12 14:56:23 | WEB | Login |
| 2 | Special User | 2013-12-12 14:56:17 | WEB | Logout |
| 3 | Special User | 2013-12-12 14:54:16 | WEB | Login |
| 4 | Special User | 2013-12-12 14:54:02 | WEB | Logout |
| 5 | Special User | 2013-12-12 14:50:27 | WEB | Login |
| 6 | Special User | 2013-12-12 14:43:07 | WEB | Logout |
| 7 | Special User | 2013-12-12 14:42:27 | WEB | 4 DI:8 90% |
| 8 | Special User | 2013-12-12 14:42:27 | WEB | 3 DI:4 30% |
| 9 | Special User | 2013-12-12 14:42:27 | WEB | 2 DI:2 60% |
| 10 | Special User | 2013-12-12 14:42:27 | WEB | 1 DI:1 100% |
| 11 | Special User | 2013-12-12 14:42:27 | WEB | SmartLogger1000-Active power reduction gradient->10 |
| 12 | Special User | 2013-12-12 14:42:26 | WEB | SmartLogger1000-Active power control mode->Remote control |
| 13 | Special User | 2013-12-12 14:42:26 | WEB | SmartLogger1000-Active power control->Enable |
| 14 | Special User | 2013-12-12 14:42:17 | WEB | 4 DI:8 90% |
| 15 | Special User | 2013-12-12 14:42:17 | WEB | 3 DI:4 30% |
| 16 | Special User | 2013-12-12 14:42:17 | WEB | 2 DI:2 60% |
| 17 | Special User | 2013-12-12 14:42:17 | WEB | 1 DI:1 100% |
| 18 | Special User | 2013-12-12 14:42:17 | WEB | SmartLogger1000-Active power reduction gradient->10 |
| 19 | Special User | 2013-12-12 14:42:17 | WEB | SmartLogger1000-Active power control mode->Remote control |
| 20 | Special User | 2013-12-12 14:42:17 | WEB | SmartLogger1000-Active power control->Disable |

7.20 Exporting Data

This topic describes how to export historical alarms, energy yield, operation logs and grid dispatching logs over the WebUI.

Exporting Data

In the **Export Data** window, you can export **Alarm History**, **Yield**, **Operation Log**, **Grid Dispatching** or **All** in CSV format, as shown in [Figure 7-77](#). Because of the limited permission, select the User name as **Advanced User** or **Special User**.

Figure 7-77 Exporting Data

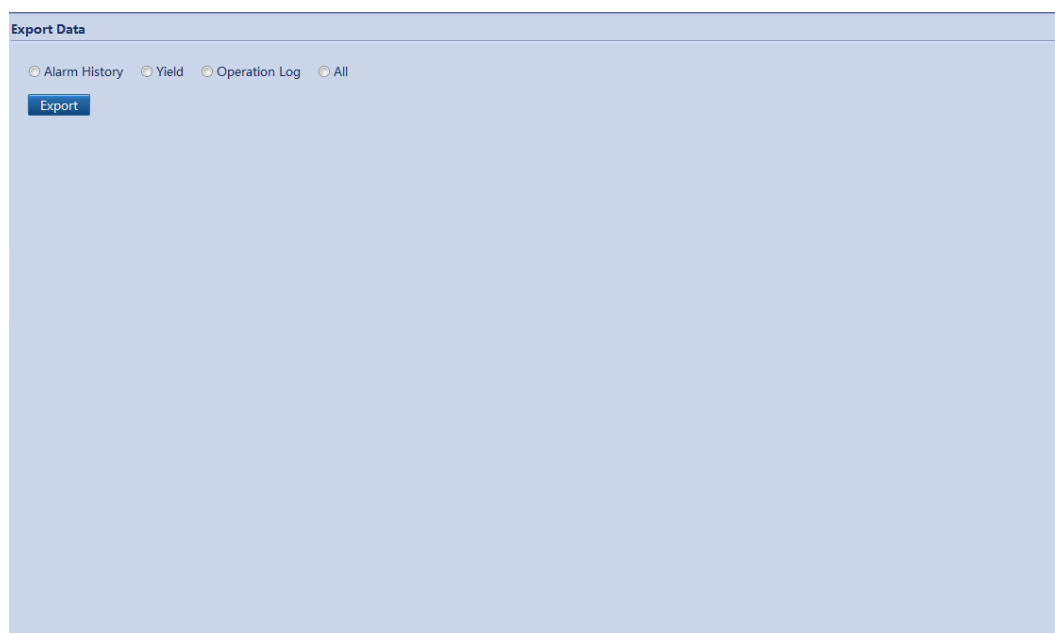

NOTE

When changing the name of the exported files, retain the extension **.tar.gz**. Otherwise, the file cannot be functional.

Opening the Exported File

The exported files are in CSV format and can be opened in Microsoft Office Excel. If the table is in disorder after file is opened, check that **List separator** is **,**. If **List separator** is not **,**, change it to **,**.

To view and change List separator, perform the following steps:

1. Open **Control Panel** and choose **Region and Language**.
2. Under **Formats**, click **Additional settings**, as shown in [Figure 7-78](#).

Figure 7-78 Viewing and changing List separator (1)

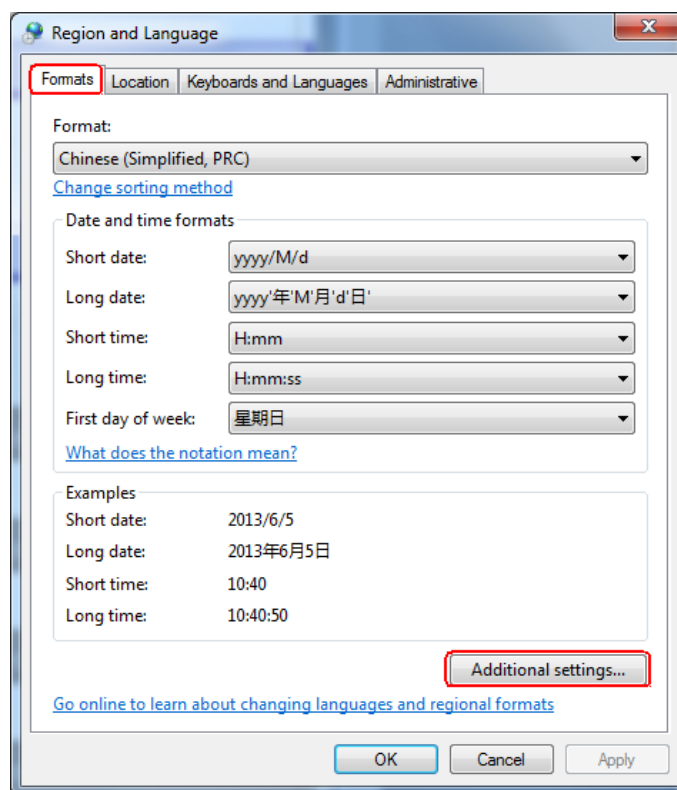

3. View and change List separator, as shown in [Figure 7-79](#).
 - If **List separator** is ,, click **OK**.
 - If **List separator** is not ,, change it to , and click **OK**.

Figure 7-79 Viewing and changing List separator (2)

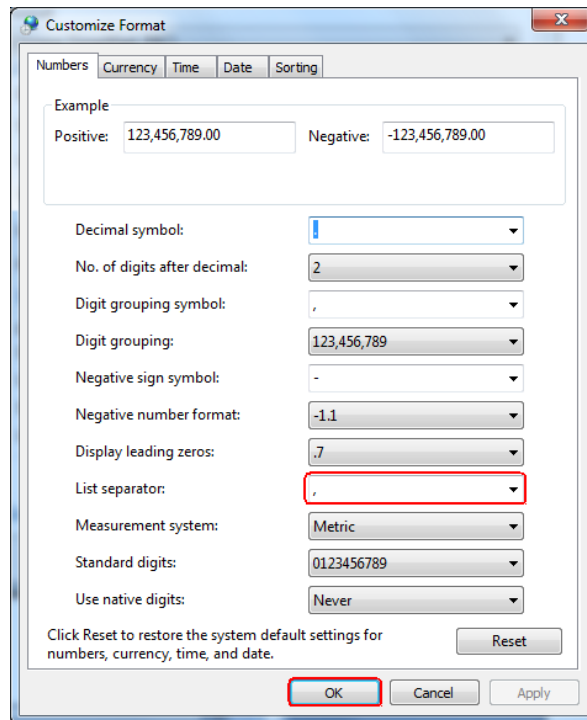

7.21 Setting Date&Time

This topic describes how to set Time Zone and Date&Time over the WebUI.

On the **Settings** tab page, choose **User Parameters > Date&Time** and set **Local time zone**, **Date**, and **Time**, as shown in [Figure 7-80](#). Because of the limited permission, select the User name as **Common User** or **Advanced User**.

Figure 7-80 Date&Time

The screenshot shows a web interface for configuring system settings. It is divided into two main sections: 'Time Zone' and 'Date&Time'.
1. **Time Zone**: A dropdown menu labeled 'Local time zone' is set to '(UTC+08:00)Beijing'. A blue 'Submit' button is located below the dropdown.
2. **Date&Time**: Two input fields are present. The 'Date' field contains '2013-12-10' with '(YYYY-MM-DD)' as a placeholder. The 'Time' field contains '16:40:52' with '(HH:MM:SS)' as a placeholder. A blue 'Submit' button is located below these fields.

**NOTICE**

- Set **Local time zone** based on the location of the inverters and enable or disable **DST** as required.
- After **Date&Time** is successfully set, this time can be synchronized in all the inverters connected to the SmartLogger.
- Modification of **Date&Time** may affect the energy yield and performance data. Therefore, change the time zone or system time with caution.

7.22 Setting Plant Information

This topic describes how to set plant information over the WebUI, including the plant name and owner and address and nationality of the plant owner.

After you set the plant information, a plant configuration file can be generated. You can upload this file to a third-party hosting website to implement remote monitoring.

On the **Settings** tab page, choose **User Parameters > Plant** and set **Plant Name**, **Plant Owner**, **Plant Owner Address**, and **Country**, as shown in [Figure 7-81](#). Because of the limited permission, select the User name as **Common User** or **Advanced User**.

Figure 7-81 Plant information

| Plant Info. | |
|---------------------|-----------------------------------|
| Plant name | <input type="text"/> |
| Plant address | <input type="text"/> |
| Plant owner | <input type="text"/> |
| Plant owner address | <input type="text"/> |
| Country | CN(China, People's Republic of) ▼ |

7.23 Setting Currency Parameters

This topic describes how to set currency parameters, such as Currency and Currency Factor, over the WebUI.

On the **Settings** tab page, choose **User Parameters** > **Currency** and set **Currency** and **Currency Factor**, as shown in [Figure 7-82](#). Because of the limited permission, select the User name as **Common User** or **Advanced User**.

Figure 7-82 Currency parameters

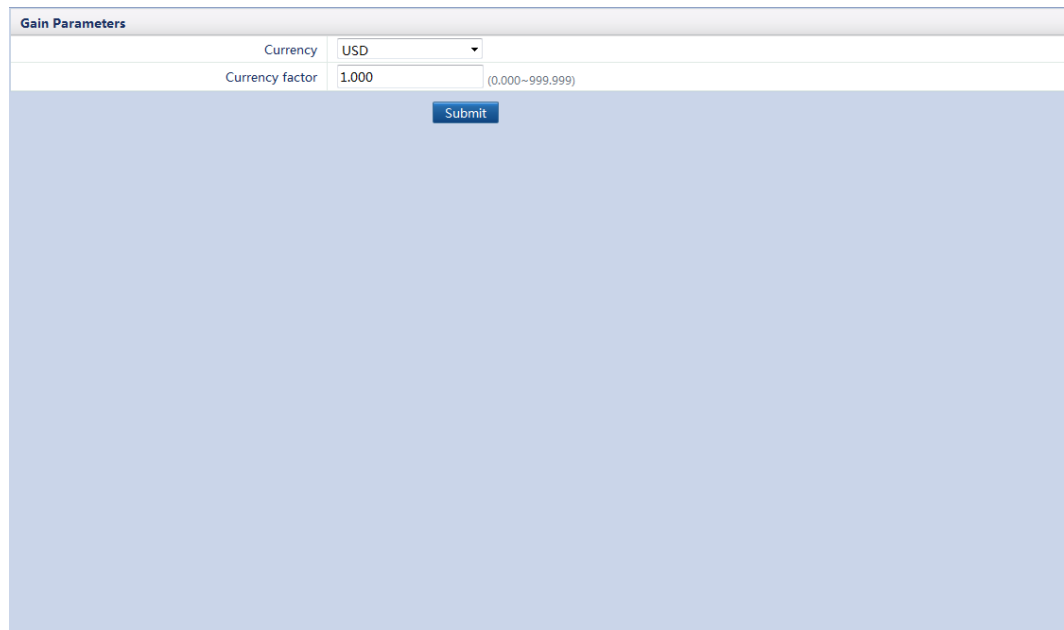

| Gain Parameters | |
|---------------------------------------|-----------------------|
| Currency | USD |
| Currency factor | 1.000 (0.000~999.999) |
| <input type="button" value="Submit"/> | |

 **NOTE**

- Four values are available for **Currency**, that is, **EUR, GBP, USD, and CNY**.
- The currency factor is the electricity price per kWh, which is used to calculate the energy yield revenue.

7.24 Setting Ethernet Parameters

This topic describes how to set Ethernet parameters, including IP Address and DNS server address over the WebUI.

Set Ethernet parameters to ensure proper operation of Ethernet ports and functions of logging in to the embedded WebUI, connecting to the network management system (NMS), and sending emails.

On the **Settings** tab page, choose **Comm. Parameters > Ethernet** and set **IP Address, Subnet Mask, Default Gateway, and DNS server address**, as shown in [Figure 7-83](#). Because of the limited permission, select the User name as **Advanced User**.

Figure 7-83 Ethernet

| Auto obtain IP | |
|---------------------------------------|-----------------------------------|
| Auto obtain IP | Disable (configurable on the LCD) |
| IP address | |
| IP address | 10, 143, 17, 248 |
| Subnet mask | 255, 255, 254, 0 |
| Default gateway | 10, 143, 16, 1 |
| DNS Server Address | |
| Primary DNS server | 10, 129, 0, 84 |
| Secondary DNS server | 0, 0, 0, 0 |
| <input type="button" value="Submit"/> | |

**NOTICE**

Take the following precautions for setting Ethernet parameters when the SmartLogger connects to the Internet through a router:

- Set the gateway address to the IP address of the router.
- Ensure that the IP address of the SmartLogger is in the same network segment as the gateway address.
- Set the DNS address to the IP address of the router or obtain the DNS address from the network provider.

When you change an IP address, a dialog box is displayed asking for your confirmation. After the IP address is changed, you need to use the new IP address to log in to the system.

7.25 Setting RS485 Parameters

This topic describes how to set RS485 parameters, including Baud Rate, Start Address, and End Address, over the WebUI.

Correctly set the parameters for the RS485 to ensure the normal communications between the SmartLogger and the inverters and between the SmartLogger and the environmental monitoring instrument.

On the **Settings** tab page, choose **Comm. Parameters > RS485** and set **Baud Rate**, **Start Address**, and **End Address**, as shown in [Figure 7-84](#). Because of the limited permission, select the User name as **Advanced User**.

Figure 7-84 RS485

| RS485-1 | |
|---------------|------------|
| Parity | None |
| Baud rate | 115200 |
| Start address | 1 (1-247) |
| End address | 67 (1-247) |

| RS485-2 | |
|---------------|-------------|
| Parity | None |
| Baud rate | 9600 |
| Start address | 1 (1-247) |
| End address | 100 (1-247) |

| RS485-3 | |
|---------------|-------------|
| Parity | None |
| Baud rate | 9600 |
| Start address | 1 (1-247) |
| End address | 100 (1-247) |
| Mode | Host |

**NOTE**

- **RS485-1** indicates communications port **COM1**, **RS485-2** indicates communications port **COM2**, and **RS485-3** indicates communications port **COM3**.
- **Parity** must be set to the same value for all devices connected to the same RS485 port.
- The following baud rates are supported: **4800 bps**, **9600 bps**, **19200 bps** and **115200 bps**.
- The default baud rate is 115200 bps if the SUN2000 is connected to a PLC and is 9600 bps if the SUN2000 is not connected to a PLC. The baud rate for the RS485 ports of the SmartLogger must be the same as this value.
- $1 \leq \text{Start Address} \leq \text{End Address} \leq 247$. The address segments for these three ports can overlap. Set the address scope properly. The broader the scope is, the longer the time is for searching the devices.

7.26 Setting EMI Parameters

This topic describes how to set parameters, including Read Function Code, Read Mode, Start Address, and End Address, for the environmental monitoring instrument over the WebUI.

Connect the SmartLogger to an EMI that complies with the standard MODBUS/485 protocol. The SmartLogger can connect to and manage only one EMI at a time.

The protocol points for EMIs provided by different vendors are varied. Therefore, to obtain information from an EMI, configure the protocol point on the WebUI of the SmartLogger properly based on the document delivered by the vendor.

On the **Settings** tab page, choose **Comm. Parameters** > **EMI** and set EMI parameters. Because of the limited permission, select the user name as **Advanced User**.

- If the EMI model is Handan or Jinzhou Yangguang, select **Handan (RYQ-3)** or **Jinzhou Yangguang (PC-4)** from the drop-down list, as shown in [Figure 7-85](#).

Figure 7-85 EMI (1)

- If an EMI of other model is used, select **Other** from the drop-down list and then set EMI parameters, as shown in [Figure 7-86](#).

Figure 7-86 EMI (2)

| No. | Signal Name | Signal address | Gain |
|-----|-----------------------|----------------|------|
| 1 | Total radiation | 2 (0-65535) | 1 |
| 2 | Ambient temperature | 0 (0-65535) | 10 |
| 3 | PV module temperature | 1 (0-65535) | 10 |
| 4 | Wind direction | 4 (0-65535) | 1 |
| 5 | Wind speed | 3 (0-65535) | 10 |

NOTE

Correctly set the parameters in accordance with the Modbus parameters provided by the EMI manufacturers. Otherwise, the EMI data cannot be correctly read.

- Based on the mode supported by the EMI, set **Read function code** to **Read holding register 03H** or **Read input register 04H**.

- Set **Data reporting mode** and **word ordering** based on site requirements.
- Based on the mode supported by the EMI, set **Read code** to **Single read** or **Multiple read**.
If **Multiple read** is set, set **Start address** and **End address** based on the acquired Modbus signal address range on the EMI.
- The **Signal address** and **Gain** of parameters like **Total radiation** and **Ambient temperature** should be set as the manufacturers require.
If a certain signal cannot be collected by the EMI, set the **Signal address** of the signal to **65535**.

7.27 Setting Power Meter Parameters

This topic describes how to set the power meter parameters on the WebUI.

On the **Settings** tab, choose **Power Meter** under **Comm. Parameters** to set the power meter parameters. To set the power meter parameters, log in as **Advanced User** or **Special User**.

Power Meter without Feedback of Grid-tied Point Data

If a power meter configured in the power station does not need to provide feedback of the grid-tied point data, set **Meter feedback output** to **Disable**.

- When the **Intelligent Power Meter Type** is **UMG604**, **PD510**, or **PZ96L**, select the model in the drop-down list box of **Intelligent Power Meter Type**.
- When the connected meter models are beyond the foregoing three, select **Other** from the drop-down list box of **Intelligent Power Meter Type** and set **Read function code**, **Read mode**, and **Data reporting mode**.

Figure 7-87 Power meter

| Power Meter Param. Settings | | | | | |
|------------------------------|---------------------------|----------------|---------------------|--------|-----------|
| Intelligent Power Meter Type | Other | | | | |
| Read function code | Read holding register 03H | | | | |
| Read mode | Multiple read | | | | |
| Data reporting mode | Integer | | | | |
| Meter feedback output | Disable | | | | |
| Start address | 305 | | (0-65535) | | |
| End address | 359 | | (0-65535) | | |
| Voltage change ratio | 1 | | (1-65535) | | |
| Current change ratio | 200 | | (1-65535) | | |
| No. | Signal Name | Signal address | Number of Registers | Gain | |
| 1 | Phase A voltage | 305 (0-65535) | 1 | 10.0 | (0-10000) |
| 2 | Phase B voltage | 306 (0-65535) | 1 | 10.0 | (0-10000) |
| 3 | Phase C voltage | 307 (0-65535) | 1 | 10.0 | (0-10000) |
| 4 | A-B line voltage | 309 (0-65535) | 1 | 10.0 | (0-10000) |
| 5 | B-C line voltage | 310 (0-65535) | 1 | 10.0 | (0-10000) |
| 6 | C-A line voltage | 311 (0-65535) | 1 | 10.0 | (0-10000) |
| 7 | Phase A current | 313 (0-65535) | 1 | 1000.0 | (0-10000) |
| 8 | Phase B current | 314 (0-65535) | 1 | 1000.0 | (0-10000) |
| 9 | Phase C current | 315 (0-65535) | 1 | 1000.0 | (0-10000) |
| 10 | Active power | 321 (0-65535) | 1 | 1000.0 | (0-10000) |
| 11 | Reactive power | 325 (0-65535) | 1 | 1000.0 | (0-10000) |
| 12 | Active electricity | 350 (0-65535) | 2 | 10.0 | (0-10000) |
| 13 | Reactive electricity | 354 (0-65535) | 2 | 10.0 | (0-10000) |

Power Meter With Feedback of Grid-tied Point Data

If the power meter configured in the power station provides feedback of the grid-tied point data over the AO port, connect the SmartLogger to an ADAM to extend an AI/AO port and log in to the WebUI to correctly configure the parameters of the extended port. To set **Extended Port Settings**, log in as **Special User**, as shown in [Figure 7-88](#).

Figure 7-88 Extended Port Settings

| AI Expansion Port | | | | | |
|-------------------|------|----------------------|------------|------------------|---------------------|
| No. | Port | 485Port | 485Address | Register Address | Port Specifications |
| 1 | AI3 | 0 (0~3,0:Disable) | 80 (0~247) | 5 (0~7) | (0~20mA) |
| 2 | AI4 | 0 (0~3,0:Disable) | 80 (0~247) | 5 (0~7) | (0~20mA) |
| AO Expansion Port | | | | | |
| No. | Port | 485Port | 485Address | Register Address | Port Specifications |
| 1 | AO1 | 0 (0~3,0:Disable) | 80 (0~247) | 5 (0~3) | (0~20mA) |
| 2 | AO2 | 0 (0~3,0:Disable) | 80 (0~247) | 5 (0~3) | (0~20mA) |
| 3 | AO3 | 0 (0~3,0:Disable) | 80 (0~247) | 5 (0~3) | (0~20mA) |
| 4 | AO4 | 0 (0~3,0:Disable) | 80 (0~247) | 5 (0~3) | (0~20mA) |
| 5 | AO5 | 0 (0~3,0:Disable) | 80 (0~247) | 5 (0~3) | (0~20mA) |

 **NOTE**

- **1 to 3** under **485Port** indicates that the AO ports connect to the COM1 to COM3 correspondingly. **0** indicates that the port is disabled.
- **485Address** is the actual 485 address set for the ADAM. Set **Register Address** based on the actual connection.
- Set **Port Specifications** based on the standards of the power grid company.

Set **Meter feedback output** under **Power Meter** to **Enable**. Set parameters for each port, as shown in [Figure 7-89](#).

Figure 7-89 Feedback GCP Param. Settings

| Power Meter Param. Settings | | | | | | |
|---------------------------------------|--------------------|--------------------|------------------|------------|----------|-----------|
| Intelligent Power Meter Type | PD510 | | | | | |
| Meter feedback output | Enable | | | | | |
| Voltage change ratio | 1 | | | | | (1-65535) |
| Current change ratio | 1 | | | | | (1-65535) |
| Feedback GCP Param. Settings | | | | | | |
| port | Feedback Parameter | Start Current (mA) | End Current (mA) | Start Data | End Data | Unit |
| AO1 | Active power | 4.000 (0-20) | 20.000 (0-20) | 0.000 | 30.000 | |
| AO2 | No | 4.000 (0-20) | 20.000 (0-20) | 0.000 | 0.000 | |
| AO3 | No | 4.000 (0-20) | 20.000 (0-20) | 0.000 | 0.000 | |
| AO4 | No | 4.000 (0-20) | 20.000 (0-20) | 0.000 | 0.000 | |
| AO5 | No | 4.000 (0-20) | 20.000 (0-20) | 0.000 | 0.000 | |
| <input type="button" value="Submit"/> | | | | | | |



NOTE

- A maximum of five concurrent AO ports can provide feedback of the grid-tied point data.
- In the **Feedback Parameter** drop-down list box, select the parameter of which the port provides feedback. One parameter corresponds to one AO port and no redundant parameters should be set.
- **Start Current** and **End Current** indicate the valid value range of signals carried by the analog output loop. The current range is smaller than or equal to the current range set in the AO specifications. **Start Data** corresponds to **End Data**.
- **Star Data** and **End Data** are the valid signal value range of the current **Feedback Parameter**. Set the two parameters based on site requirements. An excessive range results in low precision of the feedback while an insufficient range results in the incompleteness of the feedback.
- **Unit** is the unit for the current **Feedback Parameter**. When setting **Start Data** and **End Data**, note the unit selected. Otherwise, a false input and output may be caused.

7.28 Setting NetEco Parameters

This topic describes how to set NetEco parameters over the WebUI.

Set NetEco parameters to ensure normal communication between the SmartLogger and the NetEco.

On the **Settings** tab page, choose **Comm. Param.** > **NetEco** and set **NetEco** and **Security Certificate**, as shown in [Figure 7-90](#). Because of the limited permission, select the User name as **Advanced User**.

Figure 7-90 NetEco

| NetEco | |
|--|---|
| Address mode | Logical addr. ▾ |
| NetEco IP | 10, 61, 50, 227 |
| Port number | 16100 (0~65535) |
| SSL Encryption Setting | Enable ▾ |
| <input type="button" value="Submit"/> | |
| Security Certificate | |
| Upload CA certificate file | <input type="text"/> <input type="button" value="Browse..."/> <input type="button" value="Upload"/> |
| Upload local certificate file | <input type="text"/> <input type="button" value="Browse..."/> <input type="button" value="Upload"/> |
| Upload key file | <input type="text"/> <input type="button" value="Browse..."/> <input type="button" value="Upload"/> |
| <input type="checkbox"/> Enable key password | |
| <input type="button" value="Submit"/> | |

 **NOTE**

- In most cases, set **Address mode** to **Physical addr.**. If the devices connected to the three RS485 ports of the SmartLogger have duplicate addresses, you must set **Address mode** to **Logical addr.**.
- If **SSL Encryption Setting** is set to **Disable**, data will be transmitted without encryption, which may result in user data leakage. Therefore, exercise caution when deciding to set **SSL Encryption Setting** to **Disable**.
- Set **NetEco IP** correctly.

7.29 Setting Modbus TCP Parameters

You can set Modbus TCP parameters on the WebUI.

Set Modbus TCP parameters to ensure normal communication between the SmartLogger and a third-party network management system (NMS).

On the **Settings** tab page, choose **Comm. Parameters > Modbus TCP** and set **Modbus TCP** and **Security Certificate**, as shown in [Figure 7-91](#). Because of the limited permission, select the User name as **Advanced User**.

Figure 7-91 Modbus TCP

| Modbus TCP | |
|---------------------|-----------------|
| Link Setting | Enable |
| Address mode | Logical addr. |
| Client 1 IP Address | 10, 63, 157, 56 |
| Client 2 IP Address | 0, 0, 0, 0 |

**NOTE**

- Modbus-TCP is a general standard protocol without a security authentication mechanism. Therefore, the function of connecting to a third-party NMS using Modbus-TCP is disabled by default to reduce network security risks. To enable this function, set **Link Setting** to **Enable**.
- If the function of connecting to a third-party NMS using Modbus-TCP is enabled, data will be transmitted without encryption, which may result in user data leakage. Therefore, exercise caution when deciding to enable this function.
- In most cases, set **Address mode** to **Physical addr.** If the devices connected to the three RS485 ports of the SmartLogger have duplicate addresses, you must set **Address mode** to **Logical addr.**
- Set the client IP addresses correctly.

7.30 Setting IEC103 Parameters

This topic describes how to set IEC103 parameters over the WebUI.

Third-party devices that use the IEC103 interface protocol can be connected to a photovoltaic power station. The SmartLogger can read the information about such third-party devices and upload the information to the NetEco. This refines the photovoltaic power station solutions.

As Huawei inverter devices (such as inverters and AC SJBs) support different protocols from third-party devices (such as cabinet-type transformers, combiner boxes, and inverters) that use the IEC103 protocol, they cannot be connected in series on the same RS485 bus. In this case, connect third-party devices separately to the RS485 or RS232 ports of the SmartLogger, and set **IEC103** parameters on the SmartLogger WebUI.

On the **Settings** tab page, choose **IEC103** under **Comm. Parameters** and set **IEC103 port No.** and **IEC103 address**, as shown in [Figure 7-92](#). Because of the limited permission, select the User name as **Advanced User**.

Figure 7-92 IEC103

| IEC103 | |
|-----------------|-------------|
| IEC103 port No. | None |
| IEC103 address | 126 (1-255) |
| IEC103 IP | 0, 0, 0, 0 |

 **NOTE**

- IEC103 is a general standard protocol without a security authentication mechanism. Therefore, the function of connecting to the NMS using IEC103 is disabled by default to reduce network security risks. To enable this function, set **Link Setting** to **Enable**.
- Third-party devices and Huawei devices must be connected to different ports of the SmartLogger. Otherwise, the communication will be abnormal.
- Connect the cables based on site requirements and correctly set **IEC103 port No.** and **IEC103 address**.
- **IEC103 IP** must be consistent with the NMS IP address .

7.31 Setting IEC104 Parameters

You can set IEC104 parameters over the WebUI.

If the SmartLogger connects to a third-party network management system (NMS) over the IEC104 protocol, IEC104 parameters must be correctly set to enable the third-party NMS to monitor the running status of devices connected to the SmartLogger.

On the **Settings** tab page, choose **Comm. Param.** > **IEC104** and set **Link Setting**, **NetEco IP**, **Public IP address**, and **IEC104 IP**, as shown in [Figure 7-93](#). Because of the limited permission, select the User name as **Advanced User**.

Figure 7-93 IEC104

| Device | Device Address | Remote Signaling Signal No. (1-4096) | | Remote Sensing Signal No. (1-4096) | | Remote Control S |
|---------------|----------------|--------------------------------------|----------------------|------------------------------------|----------------------|----------------------|
| | | Start | End | Start | End | Start |
| Logger(Local) | 0 | <input type="text"/> | <input type="text"/> | <input type="text"/> | <input type="text"/> | <input type="text"/> |
| 20KTL(COM3-1) | 1 | <input type="text"/> | <input type="text"/> | <input type="text"/> | <input type="text"/> | <input type="text"/> |
| PID(COM3-2) | 2 | <input type="text"/> | <input type="text"/> | <input type="text"/> | <input type="text"/> | <input type="text"/> |
| EMI(COM3-5) | 5 | <input type="text"/> | <input type="text"/> | <input type="text"/> | <input type="text"/> | <input type="text"/> |

NOTE

- IEC104 is a general standard protocol without a security authentication mechanism. Therefore, the function of connecting to a third-party NMS using IEC104 is disabled by default to reduce network security risks. To enable this function, set **Link Setting** to **Enable** and correctly set **Public IP address** and **IEC104 IP**.
- If you click **Default Config.**, the **Start** and **End** values of **Remote Regulating Signal No.**, **Remote Signaling Signal No.**, **Remote Sensing Signal No.**, and **Remote Control Signal No.** parameters will be set to their default values.
- If you click **Default Config.**, the **Start** and **End** values of **Remote Regulating Signal No.**, **Remote Signaling Signal No.**, **Remote Sensing Signal No.**, **Remote Control Signal No.** will be set to 0.
- If you click **Export Config.**, configurations will be exported to a CSV file.
After the IEC104 configuration file exported from the SmartLogger and the device type IEC104 information files delivered with devices are correctly configured in a third-party NMS, the third-party NMS will be able to monitor devices connected to the SmartLogger by using the IEC104 protocol.

7.32 Setting FTP Parameters

This topic describes how to set basic parameters of the FTP server and view the latest report status over the WebUI.

The FTP function is used to access a third-party element management system (EMS). The SmartLogger can report the configuration information and running data of the managed plant system through the FTP. The third-party EMS can access Huawei devices with proper configurations.

On the **Settings** tab page, choose **Extended Parameters** > **FTP**. On the displayed page, you can set parameters in the **Basic Parameters** and **Report Settings** areas and view the information in the **Latest Report Status** area, as shown in [Figure 7-94](#). Because of the limited permission, select the User name as **Advanced User**.

Figure 7-94 FTP

| Basic Parameters | |
|------------------|--------------------------|
| FTP server | <input type="text"/> |
| User name | <input type="text"/> |
| Password | <input type="password"/> |
| Remote directory | <input type="text"/> |

| Report Settings | |
|-----------------|---|
| Data export | Disable <input type="button" value="v"/> |
| Export mode | Cyclic <input type="button" value="v"/> |
| Export interval | 5 <input type="button" value="min (5~1440)"/> |
| File Mode | Accumulated data <input type="button" value="v"/> |

| Latest Report Status | |
|----------------------|--------------------------|
| Transfer status | Server connection failed |
| Last transmission | 2013-12-03 09:09:08 |

**NOTE**

- **FTP Server** can be set to the domain name or IP address of the FTP server.
If this parameter is set to the domain name of the FTP server, ensure that the address of the DNS server is set properly.
- **User Name** and **Password** indicate the user name and password that need to be entered when you log in to the FTP server.
- Under the default directory to which data is uploaded, you can set **Remote Directory** to create a subdirectory with a name the same as the value of this parameter.
- You can click **Start report test** to check whether the SmartLogger can successfully report data to the third-party EMS.
- You can enable or disable the data report function as required.
- If you enable the data report function, you can choose to report data at regular intervals or at fixed time.
- Data reported on schedule is accumulated data, whose file name remains the same for a whole day. You can choose **Accumulated data** or **Periodically added data** to be reported within a specified cycle.

7.33 Setting Email Parameters

This topic describes how to set basic parameters of email and view the latest report status over the WebUI.

The SmartLogger can send emails to inform users of the current energy yield information of the power station system, alarm information, and equipment status, helping users to know the running conditions of the power station system in time.

When using this function, ensure that the SmartLogger can be connected to the configured email server and set the Ethernet parameters and email parameters of the SmartLogger.

On the **Settings** tab page, choose **Extended Parameters** > **Email** and set parameters in the **Basic Parameters**, **Yield**, and **Alarm** areas and view the information in the **Latest Report Status** area, as shown in [Figure 7-95](#). Because of the limited permission, select **User name** as **Advanced User**.

Figure 7-95 Email

| Basic Parameters | |
|----------------------|----------------------|
| SMTP server | <input type="text"/> |
| User name | <input type="text"/> |
| Password | <input type="text"/> |
| Email language | English ▾ |
| Send address | <input type="text"/> |
| Receive address 1 | <input type="text"/> |
| Receive address 2 | <input type="text"/> |
| Receive address 3 | <input type="text"/> |
| Receive address 4 | <input type="text"/> |
| Receive address 5 | <input type="text"/> |
| Yield | |
| Send Emails | Enable ▾ |
| Sent on sched. | 22:00 (HH:MM) |
| Alarms | |
| Send Email | Enable ▾ |
| Alarm level | Major ▾ |
| Latest Report Status | |
| Transfer status | Success |
| Last transmission | 2014-08-19 10:04:12 |



NOTE

- **SMTP Server** can be set to the domain name or IP address of the SMTP server.
If this parameter is set to the domain name of the SMTP server, ensure that the address of the DNS server is set properly.
- **User Name** and **Password** indicate the user name and password that need to be entered when you log in to the SMTP server.
- **Send address** specifies the sender's email address. Ensure that the sender's email server is the same as the server specified by **SMTP Server**. Set **Receive address** to a maximum of five addresses.
- You can enable or disable the function of sending emails to inform you of the energy yield or alarm information as required.
- You can click **Send Test Mail** to check whether the SmartLogger can successfully send emails to users.

7.34 Port Settings

This topic describes how to reset a 3G router by configuring a DO port or USB port.

When the PV plant and the element management system (EMS) are not in the same area, the SmartLogger needs to be connected to the EMS to implement the function of monitoring a remote PV plant. After you connect the SmartLogger to a router and set the Ethernet parameters, the SmartLogger can be connected to the remote EMS, SMTP mail server, or FTP server through the router.

If it is inconvenient to connect the PV plant in wired mode, you can connect it to a wireless 3G router for accessing the Internet, as shown in [Figure 7-96](#).

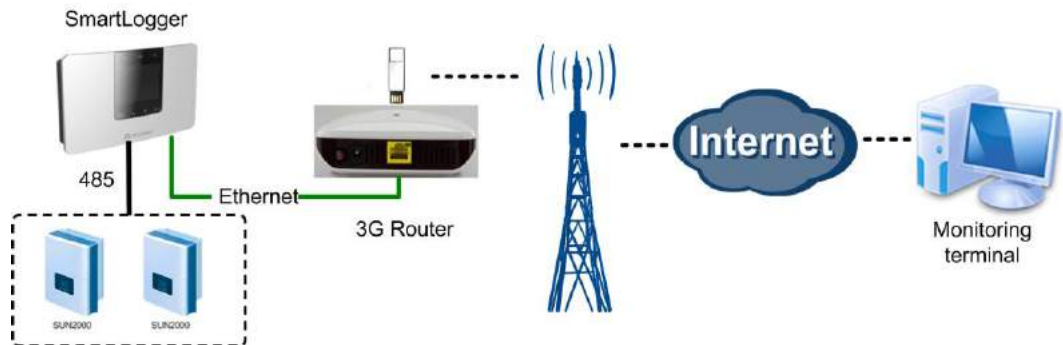
Figure 7-96 3G router networking

A 3G router is a communication device for civil use. Its reliability is limited. You can connect the DC power supply cable of a 3G router to the SmartLogger. This allows the SmartLogger to control the reset of the 3G router when the communication link is interrupted, improving the reliability of the communication link.

7.34.1 Setting DO Parameters

This topic describes how to set DO configuration parameters for resetting an external 3G router over the WebUI.

Context

The SmartLogger provides three DO ports. You can connect one DC power cable of the 3G router to one DO port in series and power on or off the wireless module by disconnecting or connecting the DO dry contact to control the reset of the 3G router.

Considering the restrictions on the current that can pass the DO port of the SmartLogger, you need to determine the number of DO ports to be used for the control based on the maximum power supply current of the 3G router (the maximum power supply current can be calculated based on the maximum power consumption and DC power supply voltage).

- When the power supply current is smaller than 1 A, use one DO port.
- When the power supply current is larger than 1 A but smaller than 1.6 A, use two DO ports.
- When the power supply current is larger than 1.6 A but smaller than 2.4 A, use three DO ports.
- When the power supply current is larger than 2.4 A, access is not allowed because the current exceeds the upper limit.

Connecting a 3G Router to the SmartLogger Over a DO Port

Before connecting a 3G router to the SmartLogger, cut off a DC power cable of the connector, and then connect the cable cut to the DO port on the SmartLogger.

- [Figure 7-97](#) shows the connection when one DO port is used.

Figure 7-97 Connecting one DO port

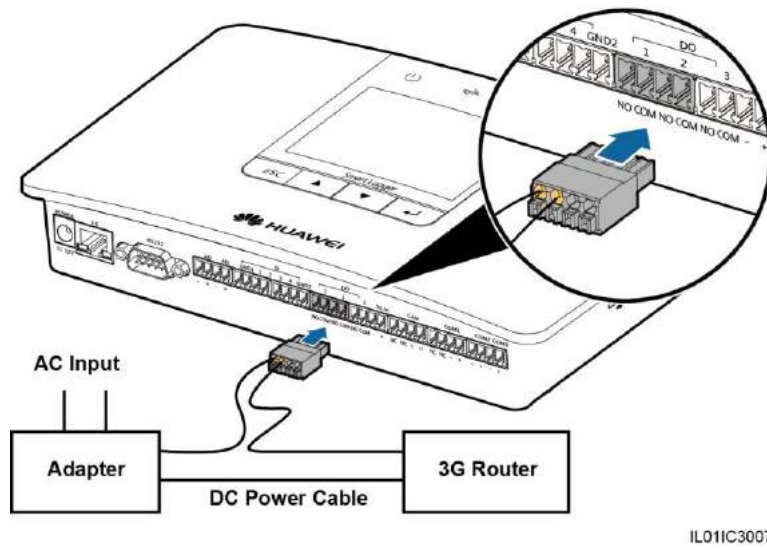

- [Figure 7-98](#) shows the connection when two DO ports are used.

Figure 7-98 Connecting two DO ports

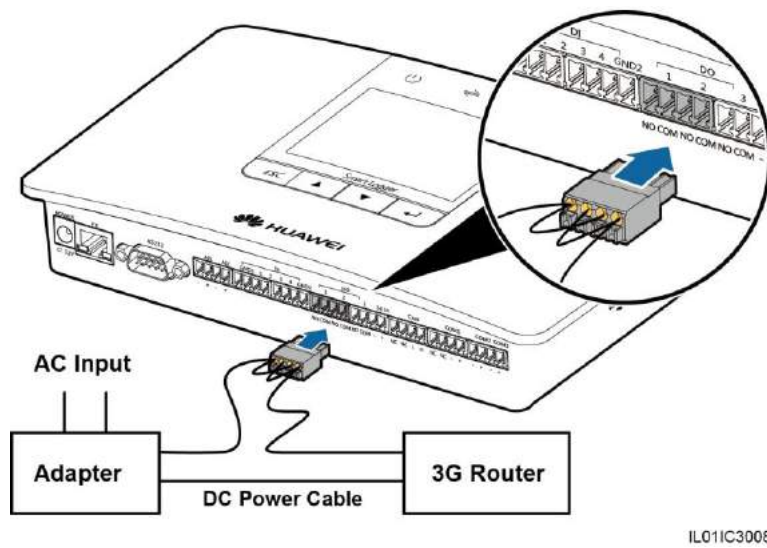

- [Figure 7-99](#) shows the connection when three DO ports are used.

Figure 7-99 Connecting three DO ports

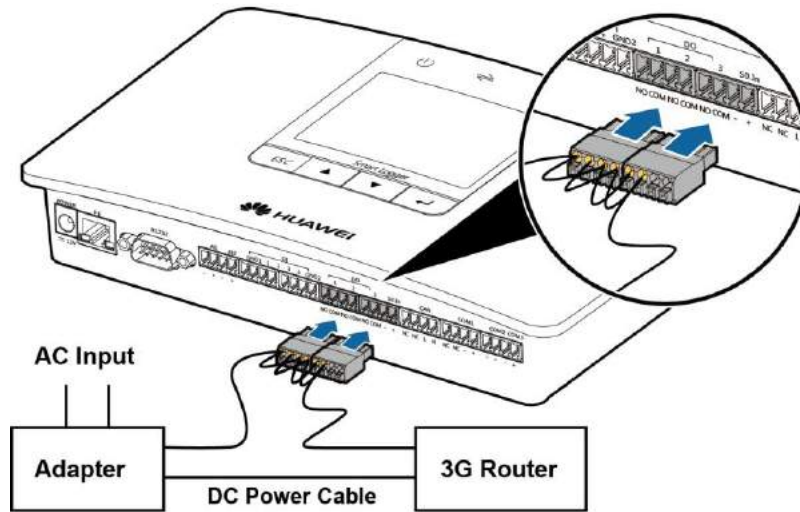

IL01IC3009

DO Configuration

After connecting the 3G router to the SmartLogger properly, you can set DO configuration parameters over the WebUI to make the external 3G router automatically reset if the SmartLogger fails to connect to the NetEco, email server and FTP server within 30 minutes.

On the **Settings** tab page, choose **Port Settings > DO** and set **DO1**, **DO2**, and **DO3** to **Reset the external router** or **No control**, as shown in [Figure 7-100](#). Because of the limited permission, select the User name as **Advanced User**.

Figure 7-100 DO configuration

| DO Configuration | |
|------------------|-----------------------------|
| DO1 | Reset the external router ▼ |
| DO2 | No control ▼ |
| DO3 | No control ▼ |



NOTE

Set **DO1**, **DO2**, and **DO3** to **Reset the external router** or **No control** based on the connections between the router and the three DO ports of the SmartLogger.

7.34.2 Setting USB Parameters

This topic describes how to set USB parameters for resetting an external 3G router over the WebUI.

Context

The SmartLogger provides a USB port, which has a power capacity of 5 V/1 A. If the DC power cable of the 3G router has a standard USB connector and has a maximum current of less than 1 A, it can directly connect to the USB port on the SmartLogger. Hence the SmartLogger can power on or off the 3G router, which allows the SmartLogger to control the reset of the 3G router when the communication link is interrupted.



NOTICE

- Only the SmartLoggers in versions later than V100R001C90SPC300 enjoy this function.
- If the maximum working current of the 3G router is greater than 1 A, it cannot be connected over a USB port.

Connecting a 3G Router over a USB

Connect the USB connector of the DC power cable of the 3G router to the USB port on the SmartLogger, as shown in [Figure 7-101](#).

Figure 7-101 Connecting the 3G router and the SmartLogger

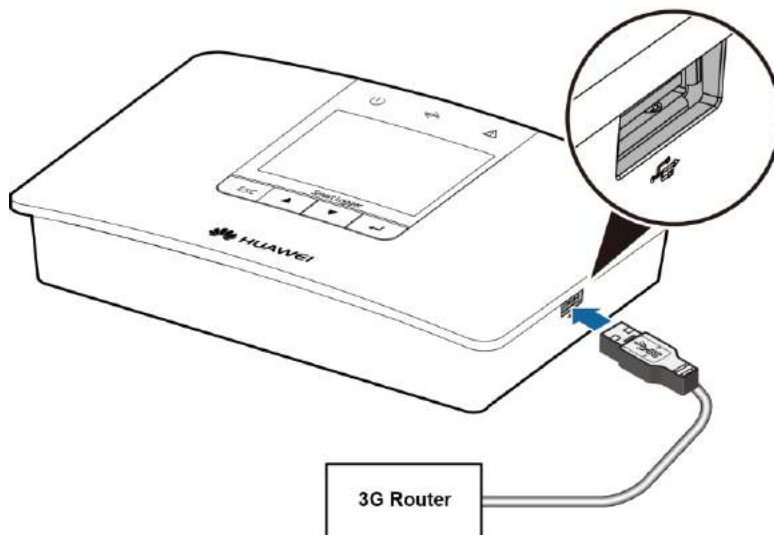

IL011C3011

USB Configuration

After connecting the 3G router to the SmartLogger properly, you can set USB configuration parameters over the WebUI to make the external 3G router automatically reset if the SmartLogger fails to connect to the NetEco, email server and FTP server within 30 minutes.

On the **Settings** tab page, choose **Port Settings > USB** and set USB to **Reset the external router** or **No control**, as shown in [Figure 7-102](#). Because of the limited permission, select the User name as **Advanced User**.

Figure 7-102 USB configuration

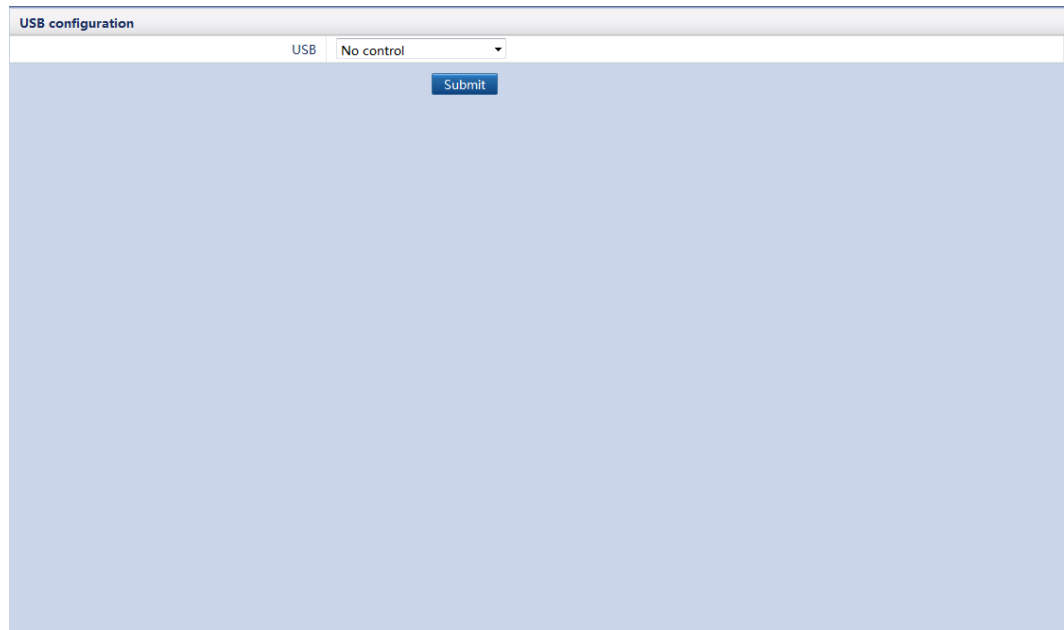

7.35 Dry Contact Remote Shutdown

You can remotely shut down dry contacts on the WebUI.

The SmartLogger provides eight DI ports, that is, DI1 (GND1) to DI4 (GND1) and DI1 (GND2) to DI4 (GND2). The OVGR can be connected to any DI port, as shown in [Figure 7-103](#).

Figure 7-103 Networking

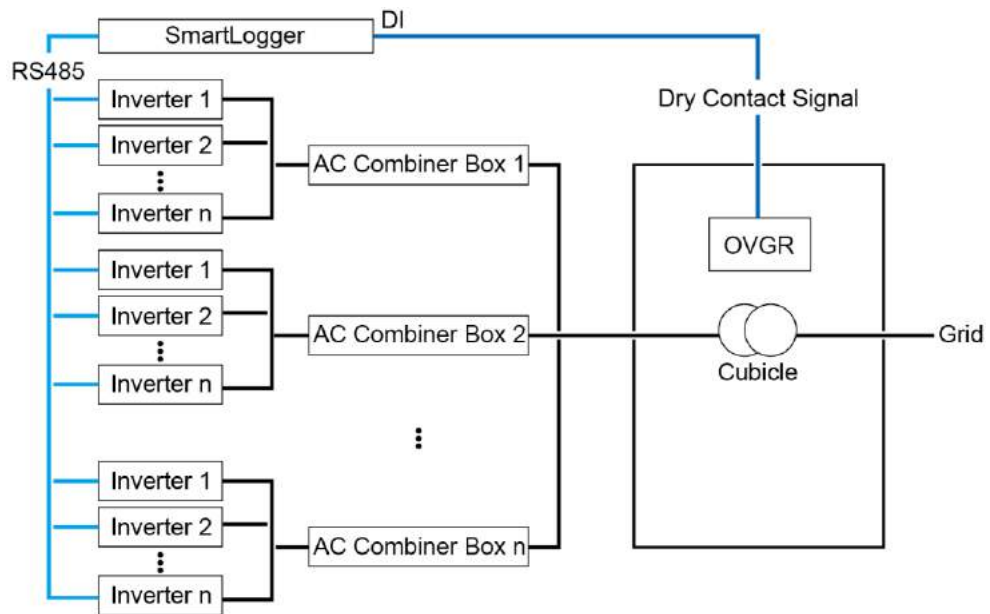

IL01IC3020

On the **Settings** tab page, select **Dry Contact Remote Shutdown** and set **Connection port**, **Effective dry contact status**, **OVGR Shutdown Setting**, and **Cubicle alarm enabling**, as shown in [Figure 7-104](#). Because of permission restriction, you must log in as **Special User**.

Figure 7-104 Dry contact remote shutdown

| Dry Contact Remote Shutdown | |
|------------------------------|---------|
| connection port | None |
| Effective dry contact status | Open |
| OVGR Shutdown Setting | Disable |
| Cubicle alarm enabling | Disable |

NOTE

- The OVGR sends dry contact signals and can be connected to any DI port of the SmartLogger. Set related parameters based on the actual connection between the OVGR and the SmartLogger. Otherwise, the dry contact remote shutdown function cannot be implemented.

- Set **Connection port** based on the actual connection between the OVGR and the SmartLogger.
- **Effective dry contact status** can be set to **Close** or **Open**. If **OVGR Shutdown Setting** is set to **Enable** and **Effective dry contact status** is set to **Close**, the SmartLogger sends the inverter remote shutdown command only when the DI port specified by **Connection port** is in **Close** state.
- **OVGR Shutdown Setting** can be set to **Enable** or **Disable**. Set **OVGR Shutdown Setting** as required.
- **Cubicle alarm enabling** can be set to **Enable** or **Disable**. If **Cubicle alarm enabling** is set to **Enable**, if the dry contact signal is effective and the Cubicle is abnormal, an alarm indicating abnormal Cubicle is generated.

7.36 Updating the firmware

This topic describes how to upgrade the firmware of the SmartLogger, inverters, AC combiner boxes, PLC, or PID over the WebUI.

On the **Maintenance** tab page, click **Firmware Upgrade** and upgrade firmware for the SmartLogger, inverters, AC combiner boxes, PLC, or PID, as shown in [Figure 7-105](#). Because of the limited permission, select **User name** as **Advanced User** or **Special User**.

Figure 7-105 Updating the firmware

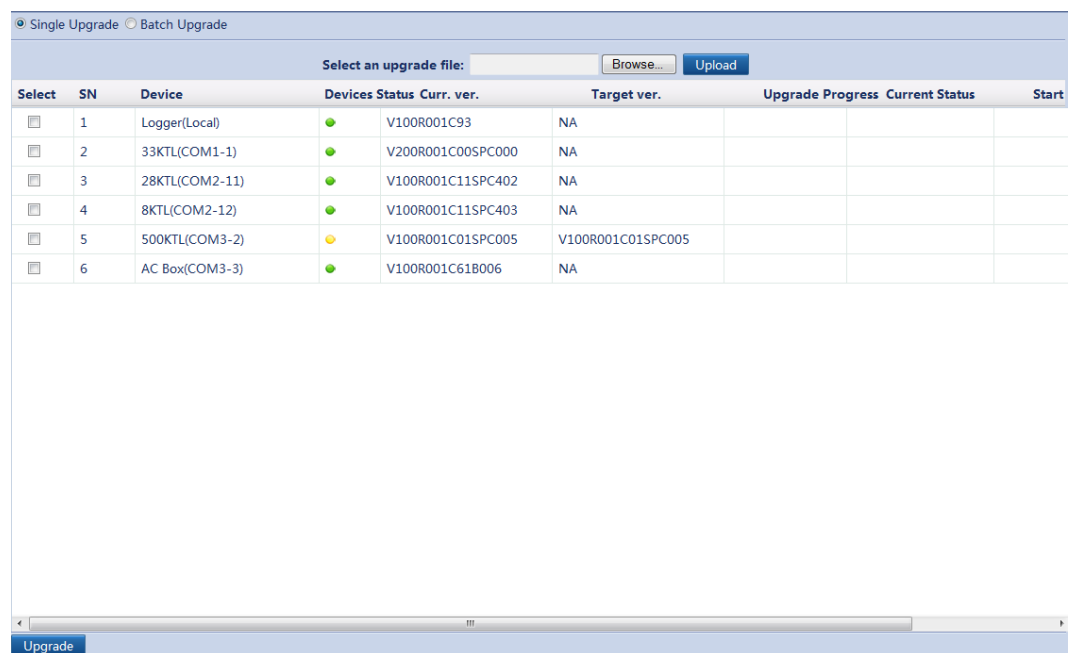

- The Single Upgrade mode will individually upgrade a specified device.
- The Batch Upgrade mode will upgrade the SUN2000 inverters in batches.

Single Upgrade

1. Select **Single Upgrade**.
2. Select the name of the device that requires a firmware upgrade.



NOTICE

The Single Upgrade mode does not apply to two or more types of device each time. For example, you cannot select both SUN2000 and SUN8000.

3. Select the upgrade file.
4. Click **Upgrade**.

Batch Upgrade

1. Select **Batch Upgrade**.
2. Select the upgrade file.
3. Click **Upgrade**.

7.37 Viewing Product Information

This topic describes how to view SmartLogger information, including SN, Hardware Version, Device Type, and Firmware Version, over the WebUI.

On the **Maintenance** tab page, click **Product Information**. **SN**, **Hardware Version**, **Device Type**, and **Firmware Version** are displayed, as shown in [Figure 7-106](#).

Figure 7-106 Product information

| Product Information | |
|-------------------------|----------------------|
| SN | 2102310QHU10D3000003 |
| Device Type | SmartLogger1000 |
| Firmware Version | V100R001C93 |

7.38 Security Settings

You can configure security settings on the WebUI.

On the **Maintenance** tab page, select **Security Settings**. Then you can modify the password and automatic logout time, as shown in [Figure 7-107](#).

Figure 7-107 Security Settings

| Security Settings | |
|--|---|
| User Name | Online Status |
| Advanced User | Online |
| Password Change | |
| Automatic logout time | |
| Automatic logout time | 4 hours |
| Submit | |
| Network Security Certificate | |
| Please select a security certificate | <input type="text"/> Browse... Upload |
| Select the network security certificate key to be uploaded | <input type="text"/> Browse... Upload |
| <input type="checkbox"/> Enable key password | |
| Submit | |
| Export certificate file | |
| Export | |



NOTE

- There are three roles of the system user: **Common User**, **Advanced User** and **Special User**. The initial password is *000001* in V100R001C95SPC010 or earlier and is *Changeme* in V100R001C95SPC020 or later.
- After the first login, it is recommended that you change the initial password immediately to ensure account security.
- You are advised to change the password at least once every half year to prevent unauthorized use of your account, which affects system security.
- It is recommended that the existing network security certificate and key (if available) be used. If a network security certificate is not available, you can export the root certificate and import the certificate to the browser.

Change the password in compliance with the following principles:

- A password must contain 6 to 20 characters.
- A password must be a combination of at least two types of digits, uppercase letters, and lowercase letters.
- The new password must be different from the old one.

7.39 System Reset

You can reset the system on the WebUI.

On the **Maintenance** tab page, select **System Reset** to reset the SmartLogger, as shown in [Figure 7-108](#).

Figure 7-108 System reset

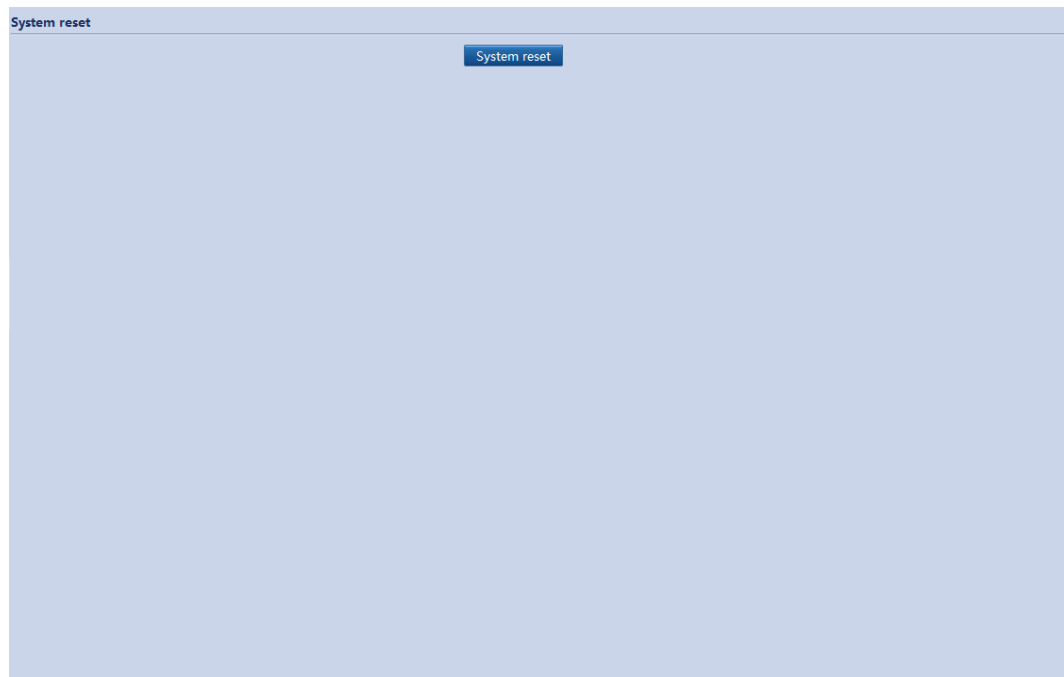

7.40 Exporting Device Logs

This topic describes how to export device logs over the WebUI.

On the **Maintenance** tab page, select **Device Log**, select the device whose logs need to be exported, and click **Export Log**, as shown in [Figure 7-109](#). Because of the limited permission, select **User name** as **Advanced User** or **Special User**.

Figure 7-109 Device Log

| Select | SN | Device | ESN | Devices Status | Progress | Execution Status | Start time | End ti |
|--------------------------|----|----------------|----------------------|----------------|----------|------------------|------------|--------|
| <input type="checkbox"/> | 1 | Logger(Local) | 2102310QHU10D3000003 | | | | | |
| <input type="checkbox"/> | 2 | 33KTL(COM1-1) | 210107164910D2001789 | | | | | |
| <input type="checkbox"/> | 3 | 28KTL(COM2-11) | 2101071361D0B3000001 | | | | | |
| <input type="checkbox"/> | 4 | 8KTL(COM2-12) | 210107147010D1000038 | | | | | |
| <input type="checkbox"/> | 5 | 500KTL(COM3-2) | NO_ESN_NUMBER | | | | | |
| <input type="checkbox"/> | 6 | AC Box(COM3-3) | 210107164910D2001208 | | | | | |

Export Log Stop Export Log archiving

NOTE

- You can click **Stop Export** to cancel the export when logs are being exported.
- After logs are exported, click **Log archiving** to open or save the log file.

7.41 Onsite Test

You can test devices onsite on the WebUI.

Inspection

If **Select a mode** is set to **Inspection** for an onsite test, you can inspect inverters, as shown in [Figure 7-110](#).

Figure 7-110 Inspection

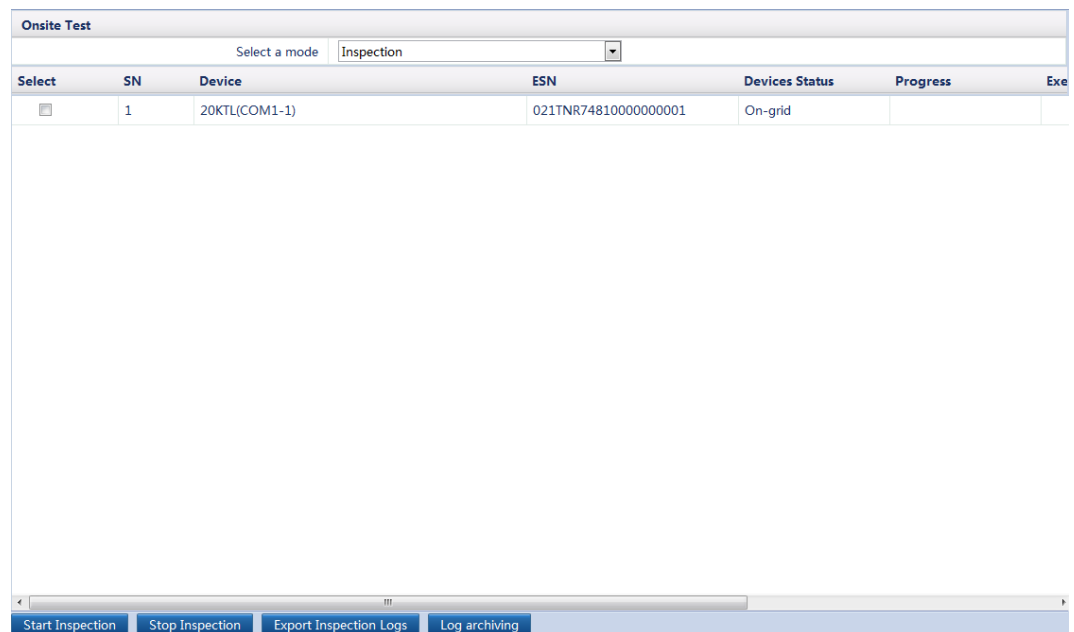

NOTE

After the inspection is completed, click **Export Inspection Logs** to export logs if necessary. After logs are exported, you can click **Log archiving** to open or save log files.

Spot-check

If **Select a mode** is set to **Spot-check** for an onsite test, you can spot-check a device whose **Grid code** is **Japan**, as shown in [Figure 7-111](#).

Figure 7-111 Spot-check

The screenshot shows a web interface for performing a spot-check. At the top, there is a section titled "Onsite Test" with a dropdown menu labeled "Select a mode" set to "Spot-check". Below this is a "Cubicle Settings" section with three rows of configuration options, each with a dropdown menu: "Cubicle alarm enabling" set to "Disable", "Cubicle connection port" set to "No", and "Cubicle alarm outp. config." set to "Open". A "Submit" button is located below these settings. Underneath is a table with the following headers: "Select", "SN", "Device", "ESN", and "Devices Status". The table body is currently empty. At the bottom of the interface, there are two buttons: "Start Spot-Check" and "Stop Spot-Check".

7.42 Device management

This topic describes how to manage devices on the WebUI.

7.42.1 Connecting a Device

You can manage devices on the WebUI.

Connecting a Device

On the **Maintenance** tab, choose **Device Mgmt.** > **Connect Device**, as shown in [Figure 7-112](#). Because of permission restriction, you must log in as **Advanced User** or **Special User**.

Figure 7-112 Connecting a device

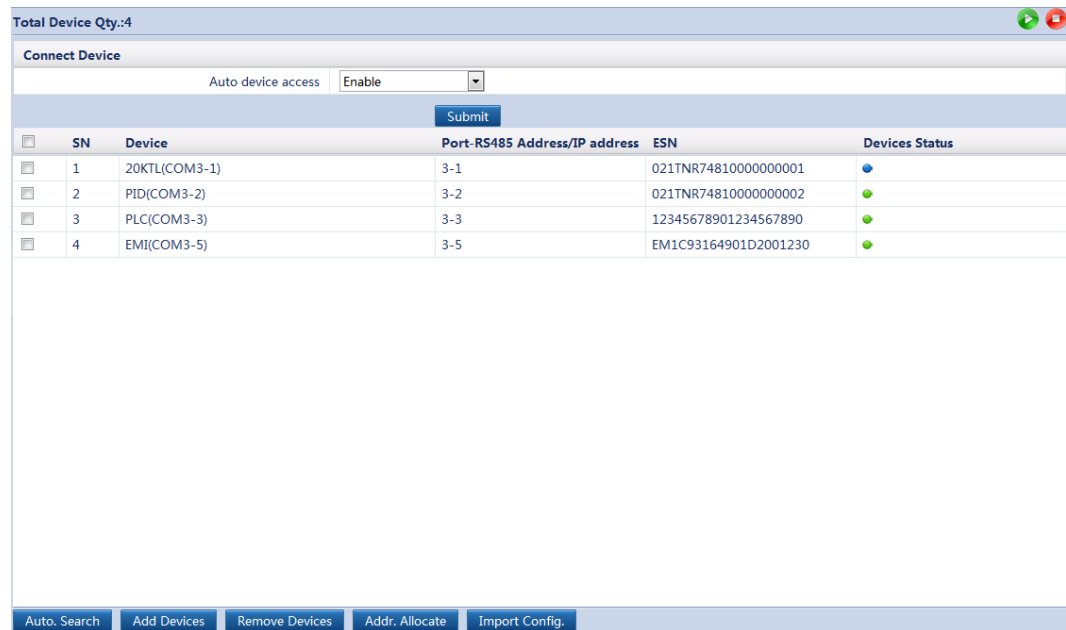

Select **Auto. Search**, **Add Devices**, **Remove Devices**, **Addr. Allocate**, or **Import Config.** based on the actual requirements.

NOTE

- If the **Auto device access** function is enabled, the SmartLogger scans the system for new devices once every 10 minutes. If a new device is found, the SmartLogger automatically connects the device. If the RS485 address of the device is already in use, the SmartLogger automatically allocates a new address to the device.
- An environment monitoring instrument (EMI), power meter, SmartLogger, PLC, and third-party devices cannot be automatically detected, and need to be added manually.
- Before adding an EMI manually, correctly set the EMI parameters. For details, see [7.26 Setting EMI Parameters](#).
- Before adding a power meter manually, correctly set the meter parameters. For details, see [7.27 Setting Power Meter Parameters](#).
- After the setting of **Addr. Allocate** is completed, device addresses can be adjusted based on sequence numbers.
- When connecting a third-party device, you can click **Import Config.** to import a configuration file and manually add the device. Then, the device can be queried on the **Monitoring** page.

Batch Power-on and Power-off

On the **Connect Device** tab, you can power on or off all the inverters connected to the SmartLogger. The power-on button (green) and power-off button (red) are located in the upper right corner of the tab as shown in [Figure 7-113](#).

Figure 7-113 Batch power-on and power-off

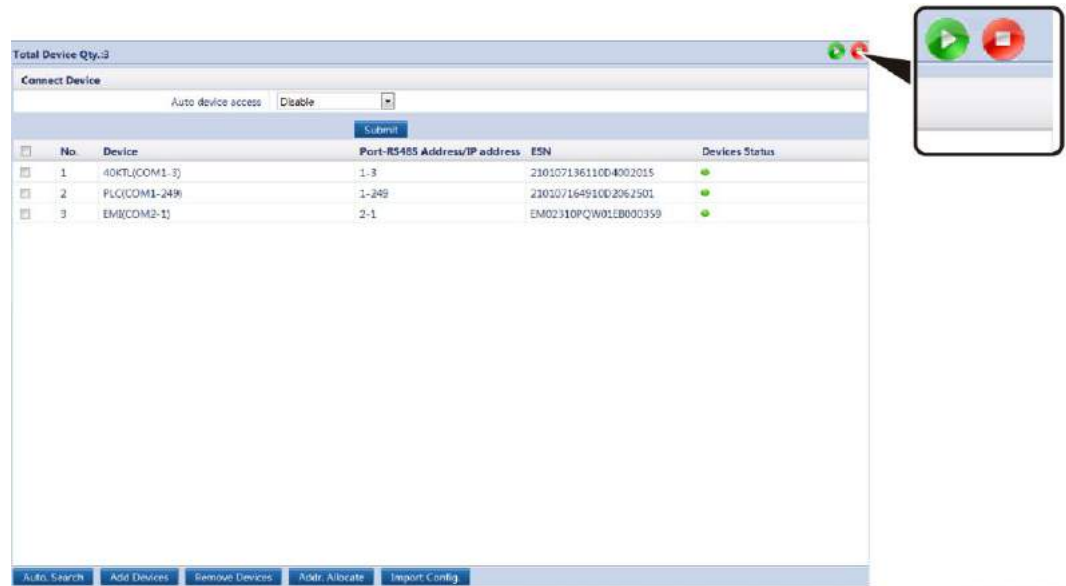

IL01CC0009

NOTE

- When you click the **Batch power on** or **Batch power off** button, the system displays a message asking you to confirm the operation. You can click **OK**.
- If a slave SmartLogger is configured in a power station, when the batch power-on/off command is sent to the master SmartLogger, the command is also synchronized to the slave SmartLogger. The slave SmartLogger then synchronizes the command to all inverters connected to it.

7.42.2 Device Name

You can modify the name of a device on the WebUI.

On the **Maintenance** tab, choose **Device Mgmt.** > **Device Name**, as shown in [Figure 7-114](#). Because of permission restriction, you must log in as **Advanced User** or **Special User**.

Figure 7-114 Device name

| <input type="checkbox"/> All | SN | Device | Port-RS485 Address | ESN | Devices Status |
|------------------------------|----|---------------|--------------------|----------------------|--------------------------------------|
| <input type="checkbox"/> | 1 | 20KTL(COM3-1) | 3-1 | 021TNR74810000000001 | ● |
| <input type="checkbox"/> | 2 | PID(COM3-2) | 3-2 | 021TNR74810000000002 | ● |
| <input type="checkbox"/> | 3 | PLC(COM3-3) | 3-3 | 12345678901234567890 | ● |
| <input type="checkbox"/> | 4 | EMI(COM3-5) | 3-5 | EM1C93164901D2001230 | ● |

Import Device Names Export Device Names Submit

NOTE

- Click **Change Device Names** to customize the name of a device.
- Click **Import Device Names** to import a CSV file that contains device names.
- Click **Export Device Names** to export the current device names to a CSV file.

7.42.3 Exporting Parameters

You can export parameters on the WebUI.

On the **Maintenance** tab, choose **Device Mgmt.** > **Export Param.**, as shown in [Figure 7-115](#). Because of permission restriction, you must log in as **Advanced User** or **Special User**.

Figure 7-115 Exporting parameters

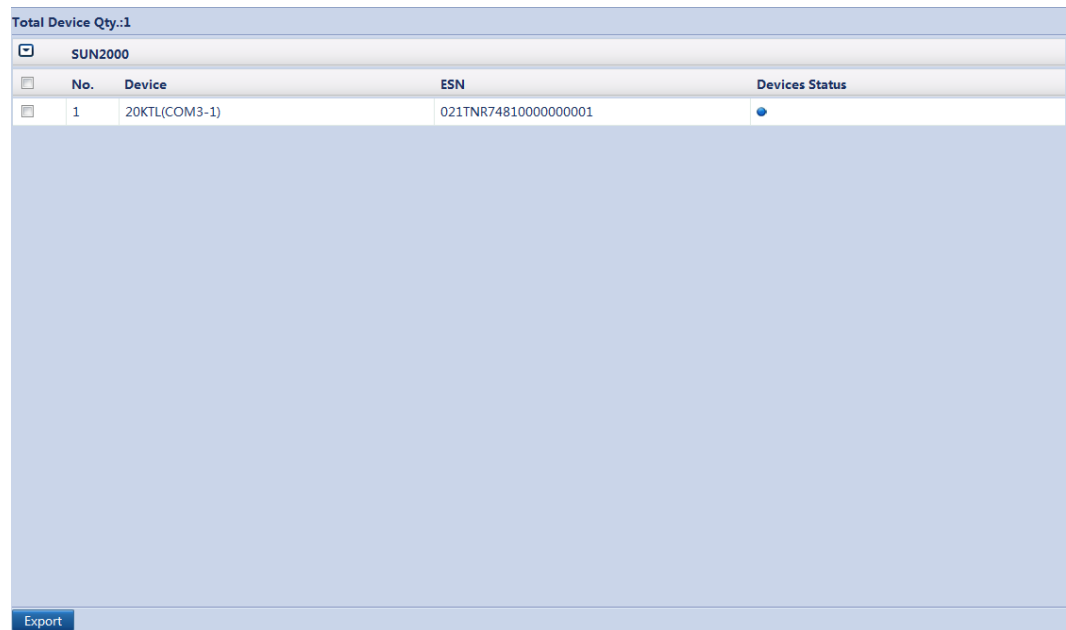

 **NOTE**

You can click **Export** to export configuration parameters of multiple SUN2000 inverters to a CSV file. Onsite engineers can then check whether the inverter configurations are correct in the exported file.

7.42.4 Resetting Alarms

You can reset alarms on the WebUI.

On the **Maintenance** tab page, choose **Device Mgmt.** > **Alarm Reset**, as shown in [Figure 7-116](#). Because of permission restriction, you must log in as **Advanced User** or **Special User**.

Figure 7-116 Resetting alarms

Total Device Qty.:1

| <input type="checkbox"/> All | No. | Device | Port-RS485 Address | ESN | Devices Status |
|------------------------------|-----|---------------|--------------------|----------------------|----------------|
| <input type="checkbox"/> | 1 | 40KTL(COM1-3) | 1-3 | 210107136110D4002015 | ● |

Submit



NOTICE

- Resetting alarms on the WebUI will delete all active and historical alarms for the selected device and enable the SmartLogger to collect new alarm data.
- If **Data Clear** is performed on the inverter, **Alarm Reset** must be performed on the SmartLogger and NMS. Otherwise, the SmartLogger cannot collect alarm information generated by the inverter after **Data Clear** is performed.
- If **Alarm Reset** or **Data Clear** is performed on the SmartLogger, **Alarm Reset** must also be performed on the NMS. Otherwise, the NMS cannot obtain alarm information collected by the SmartLogger after **Alarm Reset** or **Data Clear** is performed on the SmartLogger.

8 Grid Dispatch

This topic describes the power grid dispatching function.

In a PV power generating system, the short-term fluctuation and periodic changes of the local illumination may lead to a tremendous power fluctuation, which brings risks to the power grid running.

The power grid dispatching center should build up a real-time dispatching mechanism to ensure that the power output from the PV power generating system takes precedence during the load peak hours. If the power grid is faulty or a voltage or frequency imbalance occurs between the power generating side and the power consuming side, the power grid dispatching center sends the active power control and reactive power control command to ensure the secure power grid running.

As the core device in the communications system of the PV power station, Smart Logger receives the remote dispatching signals, analyzes the dispatching commands, and sends the commands to all the inverters connected to it. The power grid dispatching person can set all the parameters on the WebUI to meet different customers' requirements.

By integrating grid-tied PV system standards of various countries and regions, the Smart Logger also provides various and flexible power grid dispatching meet different requirements of countries and regions.

8.1 Power Grid Dispatching Modes

This topic describes the power grid dispatching modes.

Two power grid dispatching modes are available, active power control and reactive power control. Before you perform the power control for the power station, set the corresponding mode to **Enable** and then correctly set related parameters.

8.1.1 Active Power Control

This topic describes how to set the active power control mode.

The SmartLogger can send remote dispatching commands in real time to inverters connected to it, which ensures that the PV power station can quickly respond to the requirements of the power grid company.

If the power grid or the PV power station is faulty, the power grid dispatching personnel should limit the active power or disable all the active power for the power station, that is, to enable the active power reduction mode.



NOTICE

The SmartLogger controls the active power of connected inverters only when active power control is **Enable**.

Figure 8-1 Active Power Control

| Active Power Control | |
|---------------------------------|------------------------------------|
| Active power control | Enable |
| Active power control mode | Disable active power reduction |
| Active power reduction gradient | Disable active power reduction %/s |

- Dry contact remote control
- Percentage fix limitation
- Remote comm.sched.
- AI remote control

Submit

8.1.2 Reactive Power Control

This topic describes how to set the reactive power control mode.

The SmartLogger can send remote dispatching commands in real time to inverters connected to it, which ensures that the PV power station can quickly respond to the requirements of the power grid company.

Large-scale power stations are required to adjust the voltage at the grid-feeding point. Power grid dispatching personnel enables the power station to reduce or add the reactive power at the grid-feeding point, that is, to enable the reactive power compensation, based on the real-time reactive power status in the power grid.

 **NOTICE**

The SmartLogger controls the reactive power of connected inverters only when reactive power control is **Enable**.

Figure 8-2 Reactive Power Control

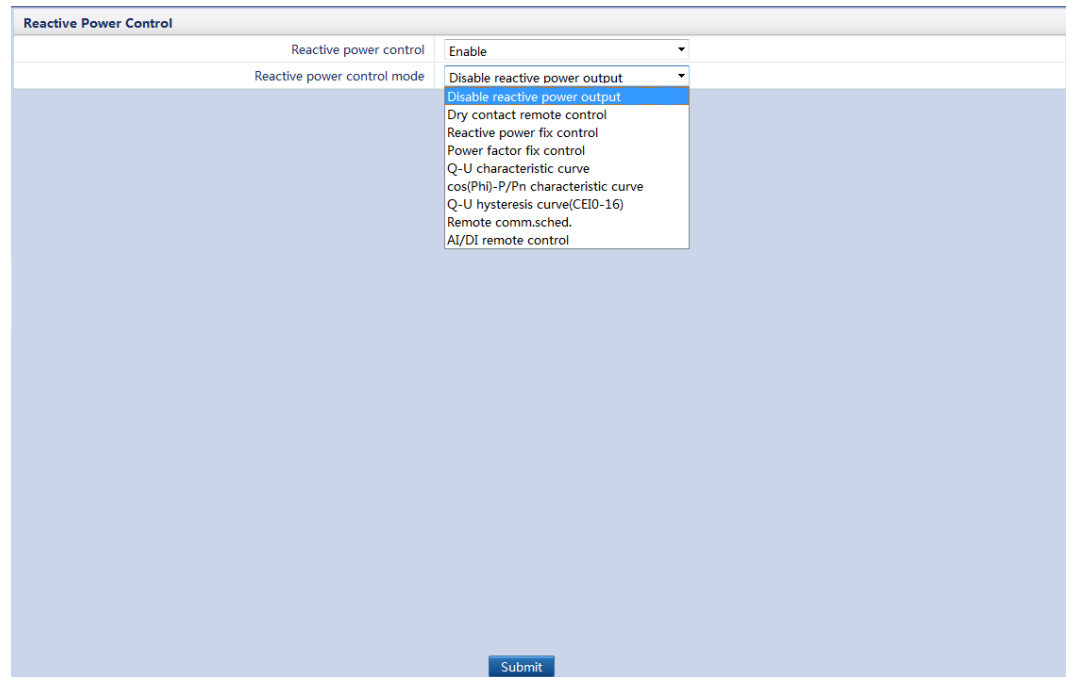

8.2 Application Scenarios

This topic describes the application scenarios of the power grid dispatching function.

Requirements of power grid dispatching vary with countries and power grid companies. The number of inverters varies in accordance with the power level of the power station and hence the networking mode differs too. A different networking mode indicates a different power grid dispatching data source and a different communication mode between the SmartLogger and the power grid. There are four application scenarios of the power grid dispatching: local dispatching, dry contact dispatching, AI/DI dispatching, and communication dispatching.

8.2.1 Local Dispatching

This topic describes the compositions and application of the local dispatching.

Local dispatching applies to power stations that have a rated power of no more than 100 kW and less than five grid-tied inverters. As the system is small-sized, the power grid company has simple requirements of power dispatching. Hence, local dispatching is sufficient.

Some power grid companies require no remote reactive power control but multiple local reactive power control modes.

You can set the power control modes on the WebUI based on the actual output features. The SmartLogger continuously controls the power output of the inverters based on the user setting.

Figure 8-3 shows the networking application of the local dispatching.

Figure 8-3 Local dispatching

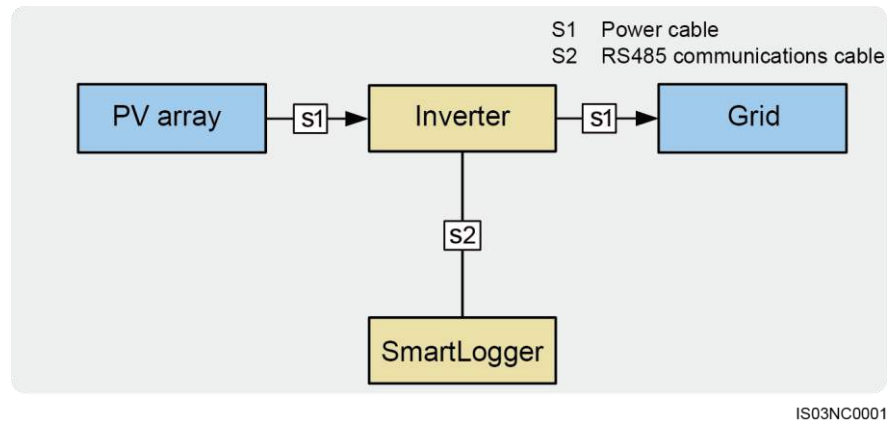

Active Power Control

The SmartLogger provides simplified local active power percentage configuration as well as the local power control automation, that is, to automatically adjust the active power reduction percentage in different periods of the day.

- If the inverters are allowed to run overloaded, set **Active Power Control Mode** to **Disable active power reduction**.



NOTICE

This function takes effect only when **Active Power Control** is set to **Enable**.

- If the maximum power output of the inverters should be controlled, set **Active Power Control Mode** to **Percentage fix limitation**.

Figure 8-4 Percentage fix limitation

| Active Power Control | | | |
|---------------------------------|------------|---------------------------|-----|
| Active Power Control | | Enable | |
| Active Power Control Mode | | Percentage fix limitation | |
| Active Power Reduction Gradient | | 2 | %/s |
| No. | Start Time | Percentage(%) | |
| <input type="checkbox"/> | 1 | 00:00:00 | 20 |
| <input type="checkbox"/> | 2 | 00:14:00 | 50 |

Add Delete Modify Submit



NOTE

- Set **Start Time** in the format of hh:mm:ss (in which hh means hour, mm means minute, ss means second).
- If no separate periods are required, users can set only one start time.
- If the inverters should run under a specified maximum power in certain periods of the day, first set **Active Power Control Mode** to **Percentage fix limitation**, add setting records based on the site requirements, and then set **Start Time** and **Percentage**.
- If the inverters should run under 70% derating power, set **Active Power Control Mode** to **Percentage fix limitation**, add one setting record, and then set **Percentage** to **70**.

Reactive Power Control

The SmartLogger provides simplified local reactive power parameters configuration as well as local power control automation, that is, to automatically adjust the power factor or absolute value of the reactive power compensation in different periods of the day.

- If the power station is not required to adjust the voltage at the grid-tied point or perform reactive power compensation, inverters can run with pure active power output. Hence, set **Reactive Power Control Mode** to **Disable reactive power output**.



NOTICE

This function takes effect only when **Reactive Power Control** is set to **Enable**.

- If the power station is required to generate at the grid-tied point a specified constant reactive power within the power factor range, set **Reactive Power Control Mode** to **Reactive power fix control**, add the setting records, and then set **Start Time** and **Reactive Power** corresponding to a certain period.

Figure 8-5 Reactive power fix control

| Reactive Power Control | | | | |
|-----------------------------|-----|------------|----------------------------|-------------------------------------|
| Reactive Power Control | | | Enable | |
| Reactive Power Control Mode | | | Reactive power fix control | |
| | No. | Start Time | Reactive Power(kVar) | Capacitive |
| <input type="checkbox"/> | 1 | 00:00:00 | 0.0 | <input type="checkbox"/> |
| <input type="checkbox"/> | 2 | 04:00:00 | 10.00 | <input checked="" type="checkbox"/> |
| <input type="checkbox"/> | 3 | 08:00:00 | 20.00 | <input type="checkbox"/> |



NOTE

- Set **Start Time** in the format of hh:mm:ss (in which hh means hour, mm means minute, ss means second).
- If no separate periods are required, users can set only one start time.
- If a "√" is under **Capacitive**, the power grid supplies capacitive reactive power to the power station. If no "√" is under **Capacitive**, the power station supplies inductive reactive power to the power grid.
- The upper threshold of **Reactive Power** is the rated output power sum of all online inverters and the lower threshold is **0**.
- Limited by the power factor (the maximum range is 1 to 0.8), the reactive power at the grid-tied point cannot stay constant when the real-time active power is small.
- If the power station is required to generate a constant power factor at the grid-tied point and the inverters are required to adjust the real-time reactive power based on the set power factor, set **Reactive Power Control Mode** to **Power factor fix control**, add the setting records, and then set **Start Time** and **Power Factor** corresponding to a certain period.

Figure 8-6 Power factor fix control

| Reactive Power Control | | | | |
|-----------------------------|------------|--------------|--------------------------|-------------------------------------|
| Reactive Power Control | | | Enable | |
| Reactive Power Control Mode | | | Power factor fix control | |
| No. | Start Time | Power Factor | Capacitive | |
| <input type="checkbox"/> | 1 | 00:00:00 | 1.000 | <input type="checkbox"/> |
| <input type="checkbox"/> | 2 | 04:00:00 | 0.900 | <input checked="" type="checkbox"/> |
| <input type="checkbox"/> | 3 | 08:00:00 | 0.800 | <input type="checkbox"/> |



NOTE

- Set **Start Time** in the format of hh:mm:ss (in which hh means hour, mm means minute, ss means second).
- If no separate periods are required, users can set only one start time.
- If a "√" is under **Capacitive**, the power grid supplies capacitive reactive power to the power station. If no "√" is under **Capacitive**, the power station supplies inductive reactive power to the power grid.
- If the remote control of the reactive power compensation is unavailable, the SmartLogger provides the Q-U characteristic curve, cos(Phi)-P/Pn characteristic curve, or Q-U Hysteresis curve(CEI0-16) for substitute. The power dispatching personnel specifies the characteristic curve according to the requirements of the local power grid and grid-tied power system and sends the signal to all the connected inverters in real time.

Set **Reactive Power Control Mode** to **Q-U characteristic curve**, as shown in [Figure 8-7](#), or to **cos(Phi)-P/Pn characteristic curve**, as shown in [Figure 8-8](#), or to **Q-U Hysteresis curve(CEI0-16)**, as shown in [Figure 8-9](#).



NOTE

- Q-U characteristic curve control mode is to dynamically adjust the ratio of the output reactive power to apparent power **Q/S** in accordance with the ratio of the actual grid voltage to the rated grid voltage **U/Un** (%).
- cos(Phi)-P/Pn characteristic curve control modes is to dynamically adjust the power factor **cosφ** in accordance with the ratio of the actual inverter output power to the rated inverter power **P/Pn** (%).
- Q-U Hysteresis curve(CEI0-16) control mode is the Italian standard CEI0-16 version of the Q-U characteristic curve. It dynamically adjusts the output reactive power of the inverter in accordance with the ratio of the actual voltage to the rated voltage of the grid-tied point. And the final value should be in the form of **Q/Pn**.

 **NOTICE**

Set the parameters of characteristic curves under instructions from professionals to ensure that the inverters work properly.

Figure 8-7 Q-U characteristic curve

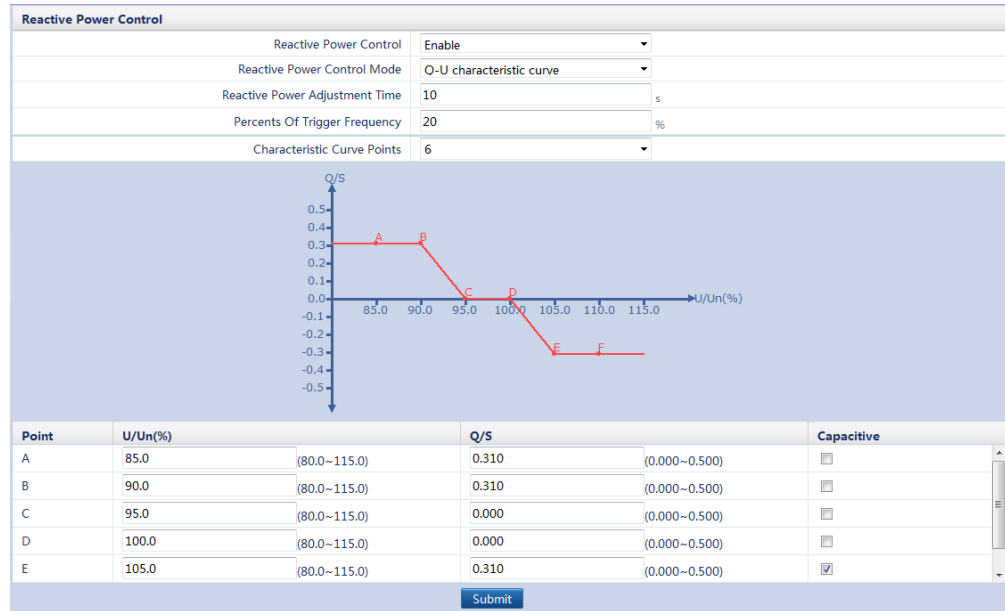

Figure 8-8 cos(Phi)-P/Pn characteristic curve

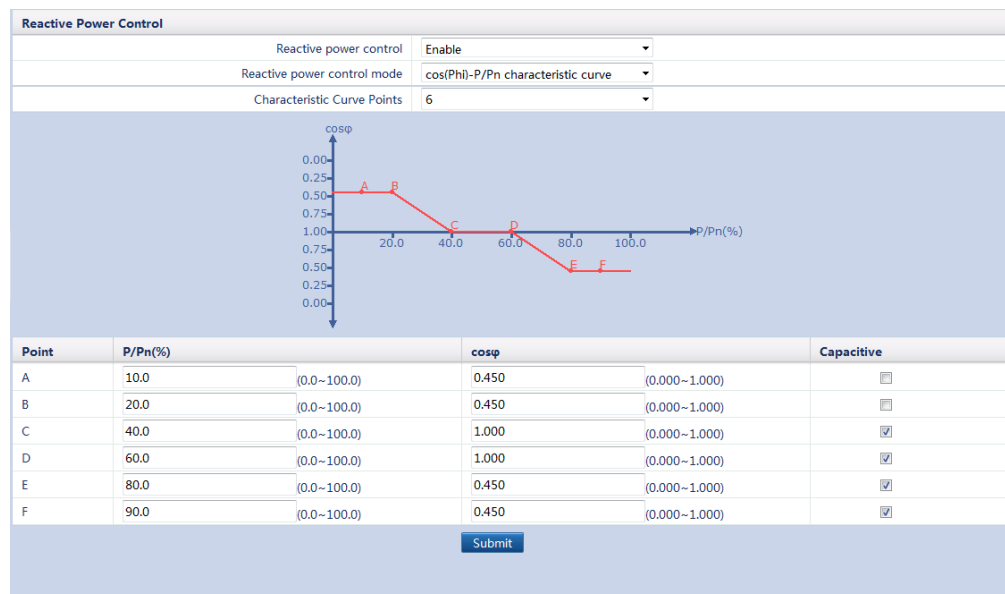
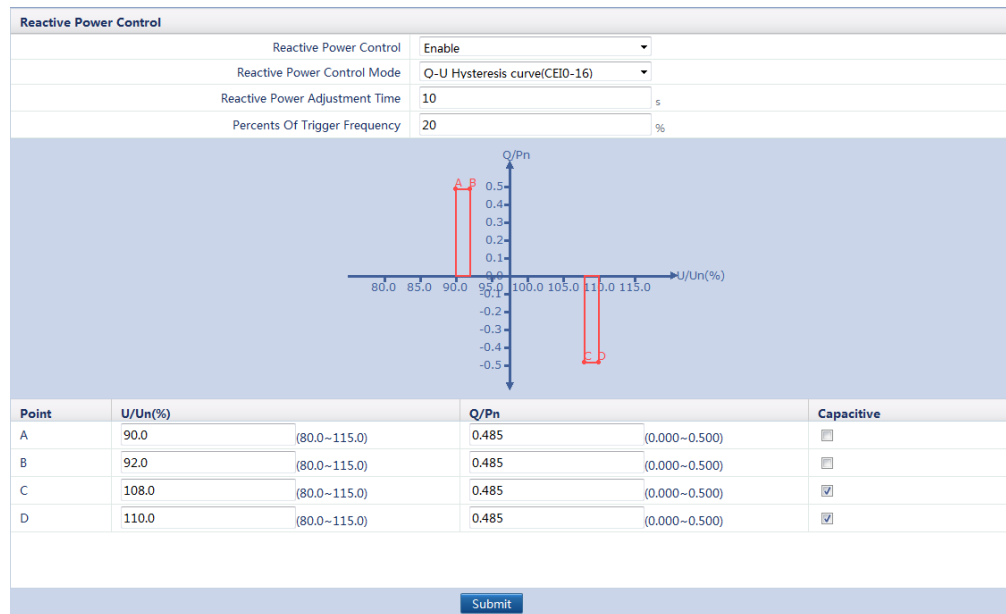

Figure 8-9 Q-U Hysteresis curve(CEI0-16)



NOTICE

When you set **Q-U Hysteresis curve (CEI0-16)**, ensure that the **Capacitive** settings of A and B are consistent, the **Capacitive** settings of C and D are consistent, and the **Capacitive** settings of A and B are different from the **Capacitive** settings of C and D.

NOTE

- When you set **Q-U Hysteresis curve (CEI0-16)**, ensure that the **U/Un(%)** or **P/Pn(%)** value of a point is larger than the **U/Un(%)** or **P/Pn(%)** value of the previous point. Otherwise, the **Invalid input** message is displayed.
- If a "√" is under **Capacitive**, the power grid supplies capacitive reactive power to the power station. If no "√" is under **Capacitive**, the power station supplies inductive reactive power to the power grid.
- Both the Q-U characteristic curve and cos(Phi)-P/Pn characteristic curve can support a maximum of 10 valid data points.
- Set **Reactive Power Adjustment Time** to specify the changing intervals of the reactive power compensation for the grid-feeding point in the PV power station. The range is 0 to 60s.
- When adding data points for the curve, refer to the provided range in the right of the text box.

8.2.2 Dry Contact Dispatching

This topic describes the compositions and application of the dry contact scheduling.

Dry contact scheduling mainly applies to power stations that have a rated power larger than 100 kW and require remote and real-time adjustment of active power and reactive power over dry contacts.

The SmartLogger scans all the dry contact signals sent from the power grid scheduling devices (the wireless receiver controller or power carrier communications devices), converts the signals into valid command data identified by the inverters, and sends the data to all the inverters connected to the SmartLogger.

[Figure 8-10](#) shows the networking application of the dry contact dispatching.

Figure 8-10 Dry contact scheduling

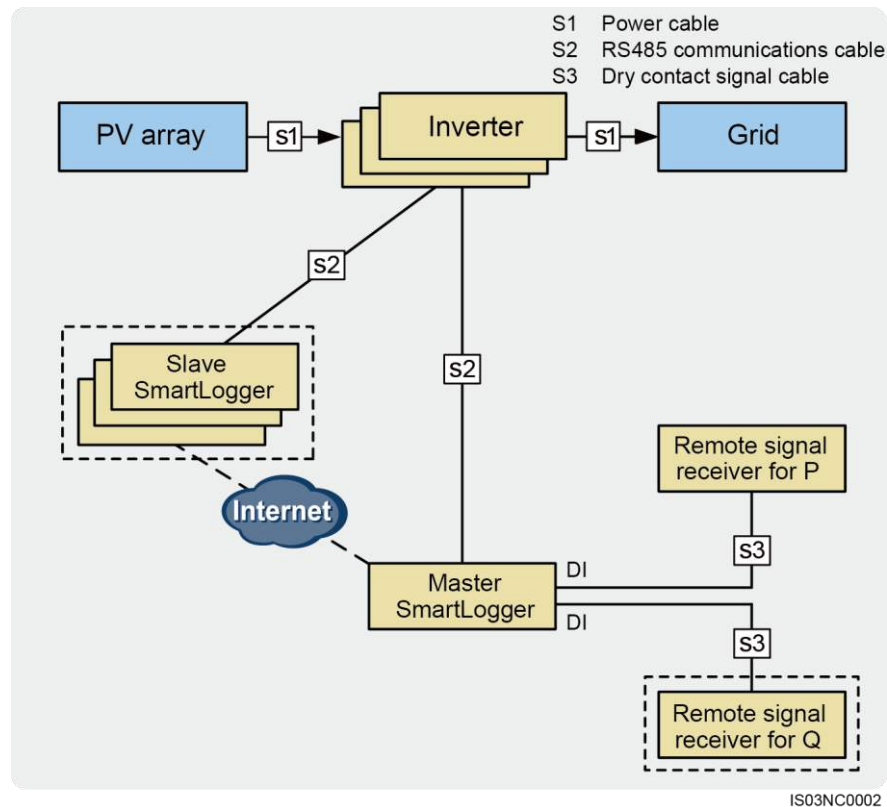

NOTICE

If a Slave SmartLogger is configured in the system, inverters should be connected to the Slave SmartLogger instead of the Master SmartLogger. Otherwise, inverters that connect to the Master SmartLogger cannot perform the power grid dispatching command.



NOTE

- Slave SmartLogger and Remote signal receiver for Q are optional access devices.
If a Slave SmartLogger is to be connected, manually add the Slave SmartLogger on the monitoring panel or WebUI of the Master SmartLogger.
- Master SmartLogger connects to Slave SmartLogger over the Ethernet. The Slave SmartLogger functions as the network device for the Master SmartLogger.
Slave SmartLogger synchronizes the commands sent by Master SmartLogger to devices connected to the Master SmartLogger.
- Remote signal receiver receives the scheduling commands sent by the power grid company, converts them into dry contact signals, and then sends them to the Master SmartLogger.
Remote signal receiver for P receives the active power scheduling commands and Remote signal receiver for Q receives the reactive power scheduling commands.

Active Power Control

Set **Active Power Control Mode** to **Dry contact remote control**, as shown in [Figure 8-11](#).



NOTICE

Ensure that the SmartLogger is properly connected to the ripple control receiver before you set **Active Power Control Mode** to **Dry contact remote control**. For details, see [4.9 Connecting the SmartLogger to a Ripple Control Receiver](#).

Figure 8-11 Dry contact remote control

| Active Power Control | | | | | | |
|---------------------------------|-----|-------------------------------------|-------------------------------------|-------------------------------------|-------------------------------------|---------------|
| Active Power Control | | | | | Enable | ▼ |
| Active Power Control Mode | | | | | Remote control | ▼ |
| Active Power Reduction Gradient | | | | | 2 | %/s |
| | No. | DI1 | DI2 | DI3 | DI4 | Percentage(%) |
| <input type="checkbox"/> | 1 | <input checked="" type="checkbox"/> | <input type="checkbox"/> | <input type="checkbox"/> | <input type="checkbox"/> | 100 |
| <input type="checkbox"/> | 2 | <input type="checkbox"/> | <input checked="" type="checkbox"/> | <input type="checkbox"/> | <input type="checkbox"/> | 60 |
| <input type="checkbox"/> | 3 | <input type="checkbox"/> | <input type="checkbox"/> | <input checked="" type="checkbox"/> | <input type="checkbox"/> | 30 |
| <input type="checkbox"/> | 4 | <input type="checkbox"/> | <input type="checkbox"/> | <input type="checkbox"/> | <input checked="" type="checkbox"/> | 0 |



NOTE

- The active power is reduced by percentage. Four levels are recommended: 100%, 60%, 30%, and 0%.
- A maximum of 16 levels is supported for the active power reduction percentage.
- If a "√" is under **Capacitive**, the power factor is a negative value, indicating that the power grid supplies reactive power to the power station. If no "√" is under **Capacitive**, the power factor is a positive value, indicating that the power station supplies reactive power to the power grid.
- The percentage levels of DI1, DI2, DI3, and DI4 should differ from each other. Otherwise, an abnormal command is generated.
- If the SmartLogger supports both active power control and reactive power control, DI1, DI2, DI3, or DI4 can be selected only once. In this case, four percentage levels are available.

Reactive Power Control

Set **Reactive Power Control Mode** to **Dry contact remote control**, as shown in [Figure 8-12](#).



NOTICE

Ensure that the SmartLogger is properly connected to the ripple control receiver before you set **Reactive Power Control Mode** to **Dry contact remote control**. For details, see [4.9 Connecting the SmartLogger to a Ripple Control Receiver](#).

Figure 8-12 Dry contact remote control

| Reactive Power Control | | | | | | | |
|-----------------------------|-------------------------------------|-------------------------------------|-------------------------------------|--------------------------|--------------|-------------------------------------|--|
| Reactive Power Control | | | | | | Enable | |
| Reactive Power Control Mode | | | | | | Remote control power factor | |
| No. | DI1 | DI2 | DI3 | DI4 | Power Factor | Capacitive | |
| <input type="checkbox"/> | <input checked="" type="checkbox"/> | <input type="checkbox"/> | <input type="checkbox"/> | <input type="checkbox"/> | 0.800 | <input type="checkbox"/> | |
| <input type="checkbox"/> | <input type="checkbox"/> | <input checked="" type="checkbox"/> | <input type="checkbox"/> | <input type="checkbox"/> | 0.850 | <input checked="" type="checkbox"/> | |
| <input type="checkbox"/> | <input type="checkbox"/> | <input type="checkbox"/> | <input checked="" type="checkbox"/> | <input type="checkbox"/> | 0.900 | <input type="checkbox"/> | |



NOTE

- A maximum of 16 levels is supported for power factors.
- "√" means low level. When the four DI ports in the SmartLogger are connected to the GND2, low level is indicated; when they are not connected to the GND2, high level is indicated.
- The power factors of DI1, DI2, DI3, and DI4 should differ from each other. Otherwise, an abnormal command is generated.
- If the SmartLogger supports both active power control and reactive power control, DI1, DI2, DI3, or DI4 can be selected only once. In this case, four power factor levels are available.
- If a "√" is under **Capacitive**, the power factor is a negative value, indicating that the power grid supplies reactive power to the power station. If no "√" is under **Capacitive**, the power factor is a positive value, indicating that the power station supplies reactive power to the power grid.

8.2.3 AI/DI Scheduling

This topic describes the compositions and application of the AI/DI scheduling.

AI/DI scheduling mainly applies to power stations that have a higher rated output power level and complex networking. The power grid company requires more remote and real-time scheduling methods, scheduling commands of higher precision, and communication of higher reliability. The power grid company adjusts the power of the power station and also requires the power station to send back the key sampling data of the grid-tied point.

One SmartLogger can connect to a maximum of 80 devices. The number of inverters is more than 80 in the AI/DI dispatching scenario. Hence, a certain number of Slave SmartLoggers should be configured. The Master SmartLogger scans over the AI/DI port the remote dispatching commands sent by the power grid company, sends them to the Slave SmartLogger. The Slave SmartLogger sends the commands to all inverters. Figure 8-13 shows the networking application of the AI/DI dispatching.

Figure 8-13 AI/DI scheduling

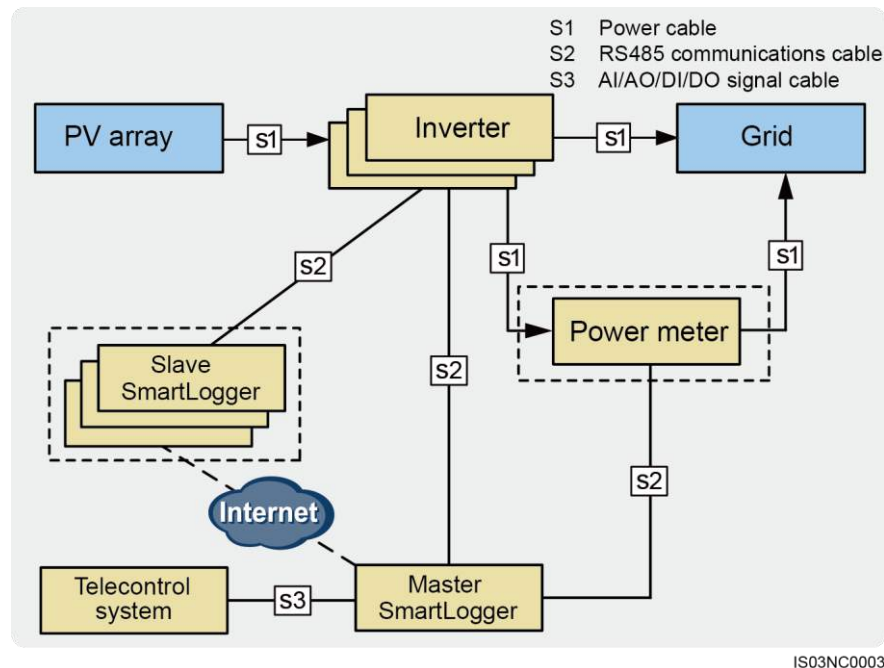

NOTICE

If a Slave SmartLogger is configured in the system, inverters should be connected to the Slave SmartLogger instead of the Master SmartLogger. Otherwise, inverters that connect to the Master SmartLogger cannot perform the power grid dispatching command.

NOTE

- The Master SmartLogger connects to the Slave SmartLogger over the Ethernet. The Slave SmartLogger functions as the network device for the Master SmartLogger.
If a Slave SmartLogger is to be connected, manually add the Slave SmartLogger on the monitoring panel or WebUI of the Master SmartLogger.
- The Master SmartLogger forwards the scheduling commands sent by the **Telecontrol system** to all Slave SmartLoggers. The Slave SmartLoggers send the commands to the connected inverters.
- The power and voltages at the grid-tied point collected by the power meter are compared with the scheduling commands from the power grid company to verify that the power station operates in accordance with requirements of the power grid company.

Port Expansion

Power grid scheduling commands are sent over AI/AO ports while the SmartLogger is not configured with AI/AO ports. Hence an ADAM device is required.

The ADAM port expansion device and remote terminal control system should both be connected to the Master SmartLogger. Figure 8-14 shows the cable connection.

Figure 8-14 Cable connection for port expansion

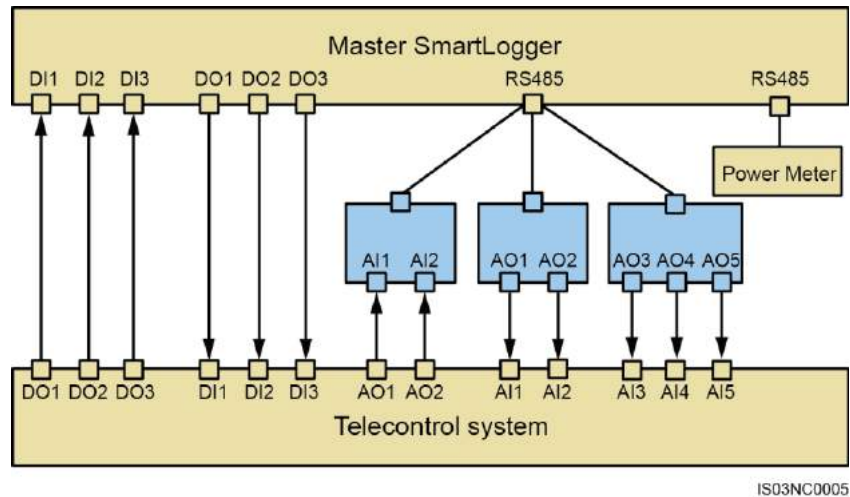

IS03NC0005

NOTE

Functions of ports in the remote terminal control system are described as follows:

- AO1 sends the active power derating command.
- AO2 sends the reactive power derating command.
- AI1 receives the active power data of the grid-tied point.
- AI2 receives the reactive power data of the grid-tied point.
- AI3 receives the voltage data of the grid-tied power point.
- AI4 receives the active power derating command feedback of the SmartLogger.
- AI5 receives the reactive power derating command feedback of the SmartLogger.
- DO1 to DO3 send the reactive power adjustment mode command.
- DI1 to DI3 receive the reactive power adjustment mode command feedback of the SmartLogger.

Extended Port Settings

Correct settings of the extended ports ensure the normal communication between the SmartLogger and power and the remote terminal control system, as shown in Figure 8-15.

Figure 8-15 Extended Port Settings

| AI Expansion Port | | | | | |
|-------------------|------|----------------------|------------|------------------|---------------------|
| No. | Port | 485Port | 485Address | Register Address | Port Specifications |
| 1 | AI3 | 0 (0~3,0:Disable) | 80 (0~247) | 5 (0~7) | (0~20mA) |
| 2 | AI4 | 0 (0~3,0:Disable) | 80 (0~247) | 5 (0~7) | (0~20mA) |
| AO Expansion Port | | | | | |
| No. | Port | 485Port | 485Address | Register Address | Port Specifications |
| 1 | AO1 | 0 (0~3,0:Disable) | 80 (0~247) | 5 (0~3) | (0~20mA) |
| 2 | AO2 | 0 (0~3,0:Disable) | 80 (0~247) | 5 (0~3) | (0~20mA) |
| 3 | AO3 | 0 (0~3,0:Disable) | 80 (0~247) | 5 (0~3) | (0~20mA) |
| 4 | AO4 | 0 (0~3,0:Disable) | 80 (0~247) | 5 (0~3) | (0~20mA) |
| 5 | AO5 | 0 (0~3,0:Disable) | 80 (0~247) | 5 (0~3) | (0~20mA) |

 **NOTE**

- **1 to 3** under **485Port** indicates that the AO ports connect to the COM1 to COM3 correspondingly. **0** indicates that the port is disabled.
- **485Address** is the actual 485 address set for the ADAM. Set **Register Address** based on the actual connection.
- Set **Port Specifications** based on the standards of the power grid company.

Power Meter Parameters Settings and Feedback GCP Parameters Settings

To configure the power meter parameters and feedback GCP parameters, see [7.27 Setting Power Meter Parameters](#).

Active Power Control

The remote scheduling command sent by the SmartLogger controls the active power output of the power station in analog input mode. Set **Active Power Control Mode** to **AI remote control**, as shown in [Figure 8-16](#).



NOTICE

Before you set **Active Power Control Mode** to **AI remote control**, ensure that connections between the SmartLogger, ADAM, and the remote terminal control system are correct.

Figure 8-16 AI remote control

| Active Power Control | | | | |
|--------------------------------------|--------------------|------------------|------------------|----------------|
| Active power control | Enable | | | |
| Active power control mode | AI remote control | | | |
| Derated command input port | AI3 | | | |
| Derated command feedback port | AO4 | | | |
| Active power reduction gradient | 10 | %/s | | |
| Value identification precision | 1 | % | | |
| Power station total rated power (Pn) | 6000 | kW | | |
| | null | 6300 | kW | |
| Active control parameters | | Setting | | |
| port | Start Current (mA) | Start Current(%) | End Current (mA) | End Current(%) |
| AI3 | 0.000 (0~20) | 0 (0~100) | 0.000 (0~20) | 0 (0~100) |
| AO4 | 0.000 (0~20) | 0 (0~100) | 0.000 (0~20) | 0 (0~100) |

Submit

 **NOTE**

- Based on the actual cable connection, select a proper **Derated command input port**.
- Based on the actual cable connection, select a proper **Derated command feedback port**.
- **Value identification precision** identifies the remote scheduling command variation threshold in the case of active power adjustment to prevent frequent control command sending due to the sampling deviation. Its setting range is 1% to 100%.
- **Power station total rated power (Pn)** is the maximum power capacity fed by the power station to the power grid agreed by the power station and the power grid company. Confirm this parameter value with the power grid company and set it correctly.
- Set **Start Current**, **End Current**, **Start Current(%)**, and **End Current(%)** based on requirements of the power grid company.

Reactive Power Control

The remote scheduling command sent by the SmartLogger controls the reactive power output of the power station in analog input mode. Set **Reactive Power Control Mode** to **AI/DI remote control**, as shown in [Figure 8-17](#).



NOTICE

Before you set **Reactive Power Control Mode** to **AI/DI remote control**, ensure that connections between the SmartLogger, ADAM, and the remote terminal control system are correct.

Figure 8-17 AI/DI remote control

| Reactive Power Control | | | | | | | |
|--|--------------------|----------------------|--------------------------|------------------|------------------|--------------------------|--|
| Reactive power control | | Enable | | | | | |
| Reactive power control mode | | AI/DI remote control | | | | | |
| Power station total rated power (Pn) | | 6000 | | | | kW | |
| null | | 6300 | | | | kW | |
| Grid connection point voltage level (Un) | | 400.0 | | | | V | |
| Reactive control parameters | | Setting | | | | | |
| <input checked="" type="radio"/> Cos(Phi) direct <input type="radio"/> Q/P curve <input type="radio"/> Q/U curve | | | | | | | |
| Dispatching mode input port | | No | | | | | |
| Dispatching mode feedback port | | No | | | | | |
| Dispatching instruction input port | | AI4 | | | | | |
| Dispatching instruction feedback port | | AO5 | | | | | |
| port | Start Current (mA) | Start Power Factor | Capacitive | End Current (mA) | End Power Factor | Capacitive | |
| AI4 | 0.000 (0~20) | 0.000 (0~1) | <input type="checkbox"/> | 0.000 (0~20) | 0.000 (0~1) | <input type="checkbox"/> | |
| AO5 | 0.000 (0~20) | 0.000 (0~1) | <input type="checkbox"/> | 0.000 (0~20) | 0.000 (0~1) | <input type="checkbox"/> | |
| Submit | | | | | | | |

 **NOTE**

- **Power station total rated power (Pn)** is the maximum power capacity of the power station agreed by the power station and the power grid company. Confirm this parameter value with the power grid company and set it correctly.
- **Grid connection point voltage level (Un)** is the voltage level at the connection point between the power station and the power grid. Set this parameter based on the power grid status.
- Set parameters under **Cos(Phi) direct**, **Q/P curve**, and **Q/U curve** respectively.

8.2.4 Communication Scheduling

This topic describes the compositions and application of the communication scheduling.

Communication dispatching mainly applies to the power stations in China that use an independent power adjustment device to send dispatching commands over the Modbus-TCP without user configuration or operation. The SmartLogger can automatically switch between dispatching modes and send dispatching commands.

Figure 8-18 shows the networking application of the communication dispatching.

Figure 8-18 Communication dispatching

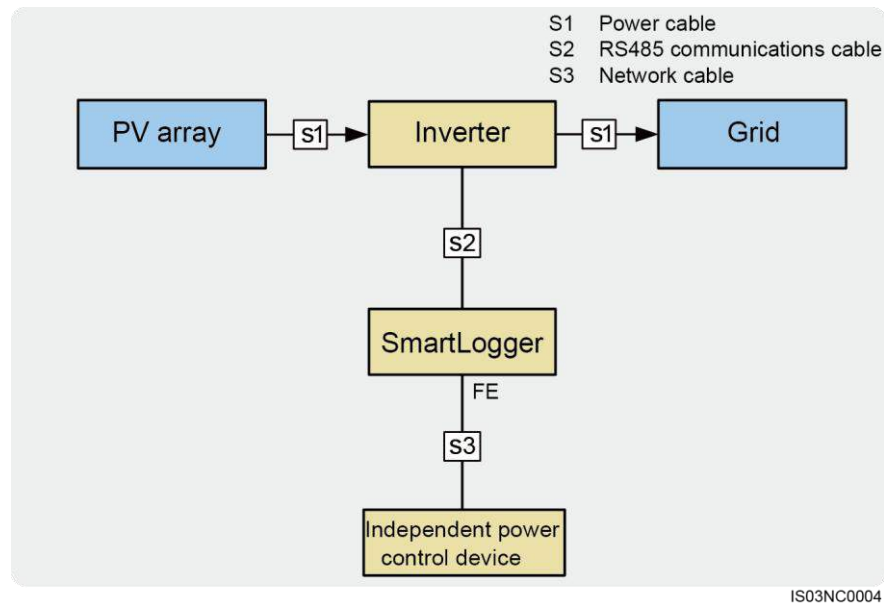

Active Power Control

When **Active Power Control Mode** is set to **Remote comm.sched.**, as shown in [Figure 8-19](#), the SmartLogger receives the scheduling commands from the upstream EMS, converts them into valid command data identified by the inverters, and then sends the data to all the connected inverters. Based on the principle of preference of remote communication scheduling, the SmartLogger automatically set **Active Power Control Mode** to **Remote comm.sched.** after receiving a scheduling command from the upstream EMS.

Figure 8-19 Remote communication dispatching

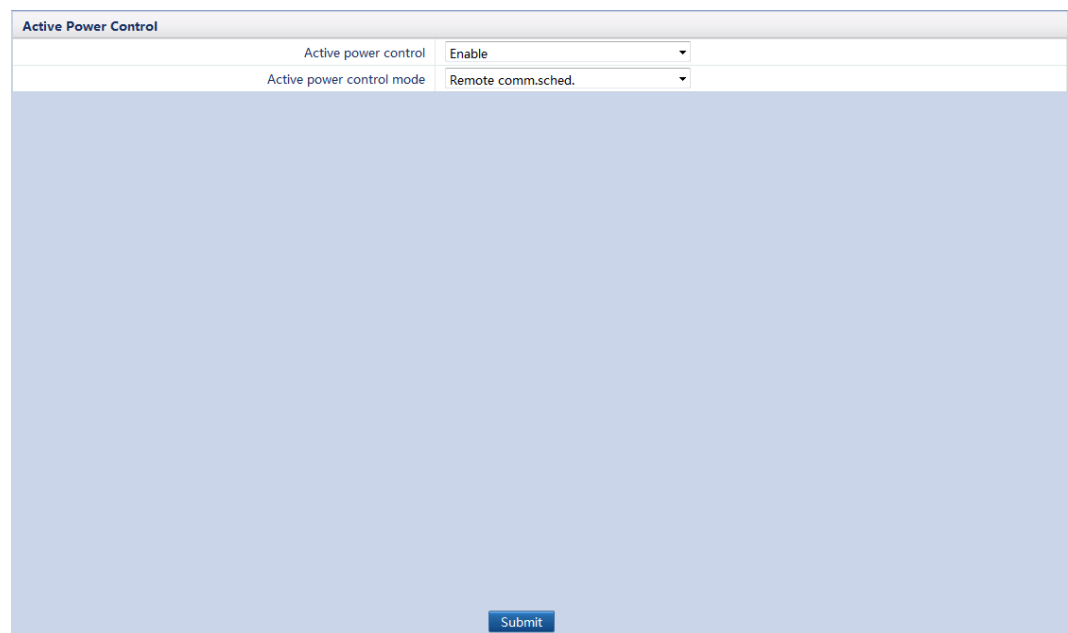

Reactive Power Control

When **Reactive Power Control Mode** is set to **Remote comm.sched.**, as shown in [Figure 8-20](#), the SmartLogger receives the scheduling commands from the upstream EMS, converts them into valid command data identified by the inverters, and then sends the data to all the connected inverters. Based on the principle of preference of remote communication scheduling, the SmartLogger automatically set **Reactive Power Control Mode** to **Remote comm.sched.** after receiving a scheduling command from the upstream EMS.

Figure 8-20 Remote communication dispatching

| Reactive Power Control | |
|-----------------------------|--------------------|
| Reactive power control | Enable |
| Reactive power control mode | Remote comm.sched. |

Submit

9 Maintenance

This topic describes how to perform daily maintenance and troubleshooting to ensure long-term proper operation of the SmartLogger.

9.1 Daily Maintenance

This topic describes the daily maintenance for the SmartLogger.

- Check that the SmartLogger is free from strong electromagnetic interference.
- Check that the SmartLogger is free from heat sources.
- Check that the heat dissipation holes are not blocked.
- Clean up the dirt and dust for the SmartLogger periodically.
- Check that the cables are secured.

9.2 Troubleshooting

This topic describes the common faults in the SmartLogger and the troubleshooting measures.

[Table 9-1](#) describes the common faults and the troubleshooting measures.

Table 9-1 Common fault list

| No. | Symptom | Possible Cause | Measures |
|-----|---------------------------------------|---|--|
| 1 | The SmartLogger cannot be powered on. | <ol style="list-style-type: none">1. The DC output terminal of the power adapter does not connect to the Power port of the SmartLogger.2. The AC input terminal of the power adapter does not connect to the AC power port.3. Power adapter is faulty.4. The SmartLogger is faulty. | <ol style="list-style-type: none">1. Connect the DC output of the power adapter to the Power port of the SmartLogger.2. Connect the AC input of the power adapter to the AC power port.3. Replace the power adapter.4. Contact the supplier or Huawei Customer Service Dept. |

| No. | Symptom | Possible Cause | Measures |
|-----|---|--|---|
| 2 | The LCD is off. | <ol style="list-style-type: none"> 1. The LCD is faulty. 2. The SmartLogger is faulty. | Contact the supplier or Huawei Customer Service Dept. |
| 3 | The LCD does not respond when a button is pressed. | <ol style="list-style-type: none"> 1. The button is faulty. 2. The SmartLogger is faulty. | Contact the supplier or Huawei Customer Service Dept. |
| 4 | Devices cannot be searched. | <ol style="list-style-type: none"> 1. The COM port does not connect to any devices or the cables are loose. 2. The communications parameters for the RS485 port are incorrect. 3. No EMI is manually added. 4. The communications parameters for the EMI are incorrect. 5. The address for the inverter is not within the search address segment set for the SmartLogger. | <ol style="list-style-type: none"> 1. Check the RS485 communications cable connection. If any cable is loose, drops off, or is reversely connected, rectify the connection. 2. Correctly set the RS485 communications parameters, and ensure that the baud rate and the communications address are correctly set. 3. Add the EMI manually. 4. Correctly set the EMI parameters 5. Set the address of the inverter to be within the search address segment set for the SmartLogger. |
| 5 | Devices Status is Disconnection on the SmartLogger. | <ol style="list-style-type: none"> 1. The cable between the device and the SmartLogger is loose or disconnected. 2. The device is powered off. 3. The baud rate or RS485 address of the device is changed. 4. The device is replaced. 5. The device is no longer connected. | <ol style="list-style-type: none"> 1. Verify that the cable between the device and the SmartLogger is properly connected and tightened. 2. Power on the device. 3. Verify the baud rate and RS485 address of the device. 4. If a device is replaced, search for or manually add the device. 5. If the device is removed, remove the device on the SmartLogger. |

| No. | Symptom | Possible Cause | Measures |
|-----|---|--|---|
| 6 | The EMI cannot be added. | <ol style="list-style-type: none"> 1. The RS485 communications cable between the EMI and the SmartLogger is not properly connected, or the RS485 communications cable is loose or disconnected. 2. The EMI is powered off. 3. The baud rate of the EMI is inconsistent with that of the SmartLogger. 4. Parameter settings of the EMI are incorrect. | <ol style="list-style-type: none"> 1. Verify that the RS485 communications cable is properly connected and tightened. 2. Power on the EMI. 3. Verify the baud rate of the EMI. 4. Log in to the WebUI and verify the parameter settings of the EMI. |
| 7 | The SmartLogger cannot communicate with the NetEco in the PC. | <ol style="list-style-type: none"> 1. The SmartLogger is not connected to the PC, or the cable between the SmartLogger and the PC is loose or disconnected. 2. Ethernet parameters are not properly set. 3. NetEco parameters are not properly set. | <ol style="list-style-type: none"> 1. Connect the Ethernet network port of the SmartLogger to the PC or router. 2. Check that the Ethernet parameters are correctly set. 3. Check that the NetEco parameters are correctly set. |
| 8 | Emails cannot be received. | <ol style="list-style-type: none"> 1. The SmartLogger cannot communicate with the email server. 2. Ethernet parameters are not properly set. 3. Email parameters are not properly set. | <ol style="list-style-type: none"> 1. Connect the Ethernet network port of the SmartLogger to the PC or router. 2. Check that the Ethernet parameters are correctly set. 3. Check that the Email parameters are correctly set. |

9.3 Alarms

This topic describes the common faults in the SmartLogger and the troubleshooting measures.

[Table 9-2](#) describes the common faults and the troubleshooting measures.

Table 9-2 Alarms

| Alarm ID | Alarm | Alarm Severity | Alarm Sub-ID | Causes | Measure |
|----------|-------|----------------|--------------|--------|---------|
|----------|-------|----------------|--------------|--------|---------|

| Alarm ID | Alarm | Alarm Severity | Alarm Sub-ID | Causes | Measure |
|----------|--------------------|----------------|--------------|--|--|
| 1100 | Abnormal P-Control | Major | 1 | Under the active power AI remote control mode, the AI port receives currents beyond the configuration range. | <ol style="list-style-type: none"> 1. Check on the ADAM4117 the cable connection of the port corresponding to the AI number. Reconnect and secure the cable if it is loose or reversely connected. 2. Enter the active power AI remote control configuration page and check that the start and end current ranges of the AI comply with the requirements of the power grid company. 3. Enter the Extended Port Settings page, check that the current configuration of the AI number is consistent with the current specification of the ADAM4117. 4. Contact the power grid company to check whether the command data sent is correct. |
| | | | 2 | Under the reactive power AI remote control mode, the command data of the AI port cannot be read due to the ADAM fault, power disconnection, or abnormal link. | <ol style="list-style-type: none"> 1. Check whether the communications cable connection between the ADAM4117 and the SmartLogger is correct, whether the RS485 address conflicts with the addresses of other devices, whether the baud rate is consistent with that set for the corresponding SmartLogger port. 2. Check whether the auxiliary power supply for the ADAM4117 is normal. |

| Alarm ID | Alarm | Alarm Severity | Alarm Sub-ID | Causes | Measure |
|----------|-------|----------------|--------------|---|--|
| | | | 3 | Under the active power AI remote control mode, the feedback command data of the AO port cannot be read due to the ADAM fault, power disconnection, or abnormal link. | <ol style="list-style-type: none"> 1. Check whether the communications cable connection between the ADAM4024 and the SmartLogger is correct, whether the RS485 address conflicts with the addresses of other devices, whether the baud rate is consistent with that set for the corresponding SmartLogger port. 2. Check whether the auxiliary power supply for the ADAM4024 is normal. |
| | | | 4 | Under the active power Dry contact remote control mode, the four DI ports read commands beyond the configuration. | <ol style="list-style-type: none"> 1. Check whether the cable connections to the DI ports are correct. 2. Enter the active power Dry contact remote control configuration page and check the mapping table of the current DI signal configuration. Contact the power grid company to check the completeness of the combination configurations in the mapping table and check whether the configurations comply with the requirements of the power grid company. |

| Alarm ID | Alarm | Alarm Severity | Alarm Sub-ID | Causes | Measure |
|----------|--------------------|----------------|--------------|--|--|
| 1101 | Abnormal Q-Control | Major | 1 | Under reactive power AI remote control mode, the AI port receives currents beyond the configuration range. | <ol style="list-style-type: none"> 1. Check on the ADAM4117 the cable connection of the port corresponding to the AI number. Reconnect and secure the cable if it is loose or reversely connected. 2. Enter reactive power AI remote control configuration page and check that the start and end current ranges of the AI comply with the requirements of the power grid company. 3. Enter the Extended Port Settings page, check that the current configuration of the AI number is consistent with the current specification of the ADAM4117. 4. Contact the power grid company to check whether the command data sent is correct. |
| | | | 2 | Under the reactive power AI remote control mode, the command data of the AI port cannot be read due to the ADAM fault, power disconnection, or abnormal link. | <ol style="list-style-type: none"> 1. Check whether the communications cable connection between the ADAM4117 and the SmartLogger is correct, whether the RS485 address conflicts with the addresses of other devices, whether the baud rate is consistent with that set for the corresponding SmartLogger port. 2. Check whether the auxiliary power supply for the ADAM4117 is normal. |

| Alarm ID | Alarm | Alarm Severity | Alarm Sub-ID | Causes | Measure |
|----------|---------------------|----------------|--------------|---|--|
| | | | 3 | Under the reactive power AI/DI remote control mode, the command data of the AO port cannot be read due to the ADAM fault, power disconnection, or abnormal link. | <ol style="list-style-type: none"> 1. Check whether the communications cable connection between the ADAM4024 and the SmartLogger is correct, whether the RS485 address conflicts with the addresses of other devices, whether the baud rate is consistent with that set for the corresponding SmartLogger port. 2. Check whether the auxiliary power supply for the ADAM4024 is normal. |
| | | | 4 | Under the reactive power Dry contact remote control mode, the four DI ports read commands beyond the configuration. | <ol style="list-style-type: none"> 1. Check whether the cable connections to the DI ports are correct. 2. Enter the reactive power Dry contact remote control configuration page and check the mapping table of the current DI signal configuration. Contact the power grid company to check the completeness of the combination configurations in the mapping table and check whether the configurations comply with the requirements of the power grid company. |
| 1102 | Abnormal Meter Data | Major | 1 | The electricity meter cannot properly send feedback signals to a third-party scheduling device due to the ADAM fault, power disconnection, or abnormal link. | <ol style="list-style-type: none"> 1. Check whether the communications cable connection between the ADAM4024 and the SmartLogger is correct, whether the RS485 address conflicts with the addresses of other devices, whether the baud rate is consistent with that set for the corresponding SmartLogger port. 2. Check whether the auxiliary power supply for the ADAM4024 is normal. |

| Alarm ID | Alarm | Alarm Severity | Alarm Sub-ID | Causes | Measure |
|----------|--------------------|----------------|--------------|---|--|
| 1103 | Breaker Disconnect | Major | 1 | The general AC circuit breaker at the grid-tied point is OFF. | Check whether the disconnection of the circuit breaker is a normal operation. Otherwise, contact the service engineer to restore the connection. |

10 Disposing of the SmartLogger

This topic describes how to dispose the SmartLogger.

If the service life of the SmartLogger expires, dispose of the SmartLogger according to the local disposal act for waste electric appliances. You can also return it to Huawei, with the related expenses paid.

11 Technical Specifications

This topic describes the SmartLogger technical specifications.

Device management

| Specifications | SmartLogger1000 |
|------------------------------------|--------------------------------|
| Number of managed devices | 80 |
| Communications mode | Three RS485 ports |
| The maximum communication distance | RS485: 1000 m; Ethernet: 100 m |

Display

| Specifications | SmartLogger1000 |
|----------------|------------------|
| LCD | 3.5-inch LCD |
| Indicator | Three indicators |
| WEB | Embedded |

Common parameters

| Specifications | SmartLogger1000 |
|------------------------|---|
| Power supply | 100 V AC to 240 V AC, 50 Hz or 60 Hz |
| Power consumption | Normal: 3 W; maximum: 7 W |
| Storage capacity | Stores historical inverter performance data of the last month |
| Language | English, Chinese, German, Italian, Japanese, French |
| Dimensions (H x W x D) | 140 mm x 225 mm x 50 mm |

| Specifications | SmartLogger1000 |
|---------------------------------------|---|
| Weight | 500 g |
| Operating temperature | -20 °C to +60 °C |
| Relative humidity (non-condensing) | 5%-95% |
| Protection level | IP20 |
| Installation mode | Installed on a wall, desk, or along a guide rail. |

Port

| Specifications | SmartLogger1000 |
|-------------------------|---------------------|
| Ethernet | 10/100M, Modbus-TCP |
| RS485 | Modbus-RTU |
| USB | Supported |
| Digital parameter input | 4 |
| Analog input | 2 |
| Relay output | 3 |

12 Quality Assurance

Warranty

During the warranty, the user should provide the invoice and date. At the same time, the signs on the products should be clear. Otherwise, Huawei will not be liable for the quality assurance. The warranty period for the SmartLogger is 24 months. The warranty starts from the time that the customer accepts the equipment, and the starting date should be within 90 days after delivery. The contract prevails if it specifies the warranty.

Quality Assurance Regulations

- Huawei maintains or replaces the equipment freely if the equipment becomes faulty within the warranty.
- Return the faulty or damaged equipment to Huawei.
- The customer reserves appropriate time for Huawei to maintain the faulty equipment.

Disclaimer

- Damage caused during transportation
- Incorrect installation
- Misoperation
- Damage caused by abnormal natural environments
- Operation under severe environments which are not specified in this document
- Unauthorized product changes and software code modification
- Usage under installation and operating environments which are not specified in related international specifications
- Neglect of the safety precautions and regulations specified in this document

A Monitoring User List

Table A-1 Monitoring user list

| Login Mode | User Name | Initial Password |
|-------------------|------------------|-------------------------|
| LCD | Common User | 000001 |
| | Advanced User | 000001 |
| | Special User | 000001 |
| WEB | Common User | Changeme |
| | Advanced User | Changeme |
| | Special User | Changeme |
| SSH | root | Changeme |