

PHOTOVOLTAÏQUE

# GSE IN-ROOF SYSTEM™

Total integration system for traditional photovoltaic panels

## Installation manual - UNIVERSAL kit

V 11.2



CHUBB®



**GSE** Integration

EUROPEAN LEADER IN PHOTOVOLTAIC INTEGRATION SYSTEMS



<b>1</b>	<b>Kit presentation</b>	<b>4</b>
1.1	Presentation of the GSE In-Roof	4
1.2	System™ Contents of the kit	5
1.3	GSE PORTRAIT Frame	6
1.4	GSE LANDSCAPE Frame	7
1.5	Tools required	8
<b>2</b>	<b>Building site preparation</b>	<b>9</b>
2.1	Climatic Conditions	9
2.2	Location on the roof	9
2.3	Determine wind pressure of the project	10
<b>3</b>	<b>Implementation</b>	<b>12</b>
3.1	Preparation of the roof covering	12
3.2	Positioning of the support battens	13
3.3	Low sealing strip installation	15
3.4	GSE Frames installation	16
3.5	Lateral flashings installation	18
3.6	PV modules installation	20
3.7	Top flashings installation	24
3.8	Specific case : PV array with inner/outer angles	27
3.9	Connection to the roof covering	29
<b>4</b>	<b>Maintenance and servicing</b>	<b>30</b>
4.1	Verification	30
4.2	Module replacement	30
<b>5</b>	<b>Assistance and contact</b>	<b>31</b>
5.1	Training session	31
5.2	Technical assistance	31
<b>6</b>	<b>Certifications and warranties</b>	<b>31</b>
6.1	Technical assessments	31
6.2	Fireproofness test	31

# 1. Kit presentation

## 1.1 GSE In-Roof System™

**GSE In-Roof System™** enables modules installation **on every type of roof covering (curved tiles, interlocking, flat tiles, slates)**, as well as on new buildings like retrofit buildings.

The mounting system may be installed in a **portrait or landscape** orientation, with a specific frame for each format, suitable for small installations (less than 3 kWp) and large roofs (ie dedicated manual).

**GSE In-Roof System™** must be installed on the wooden substructure of the buildings and mounted on specific battens, adapted to climatic conditions. It can be mounted on slopes between **12° and 50°**.

**GSE In-Roof System™** is **guaranteed for 10 years by the manufacturer**. The system doesn't require much maintenance, except regular cleaning of the PV panels to guarantee an optimum production.

**Complementary manuals available :**

- **GSE Intégration In-Roof System v. TS-1**
- **GSE Intégration In-Roof System v. A-1**
- **GSE Intégration In-Roof System Industrial roofs**
- **GSE Intégration In-Roof System Roof window**



# 1. Kit presentation

## 1.2 Contents of the kit

### ◆ MOUNTING FRAME



GSE Portrait Frame



GSE Landscape Frame

### ◆ MOUNTING CLAMPS



Wood self-drilling screw 6,5 x 60

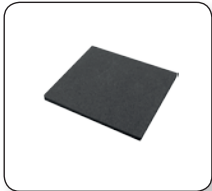

EPDM Foam



End clamp



Middle clamp



Edge wedges (L/R)

### ◆ FLASHINGS



Flashing hook

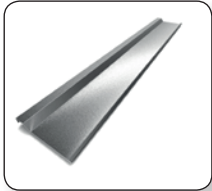

Lateral flashing

OPTION 1

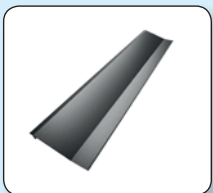

Top flashing



Attach angle



Aluminium pop rivet

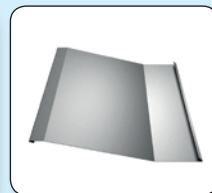

Top flashing junction

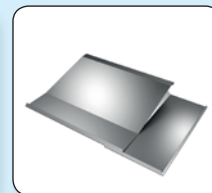

Corner flashing



Sheet of zinc

OPTION 2

### ◆ WATERPROOFING



Flexalu TM or eq.



Sheet of zinc



Lead tape



Precompressed seal



HPV roof underlayment

# 1. Kit presentation

## 1.3 GSE PORTRAIT Frame

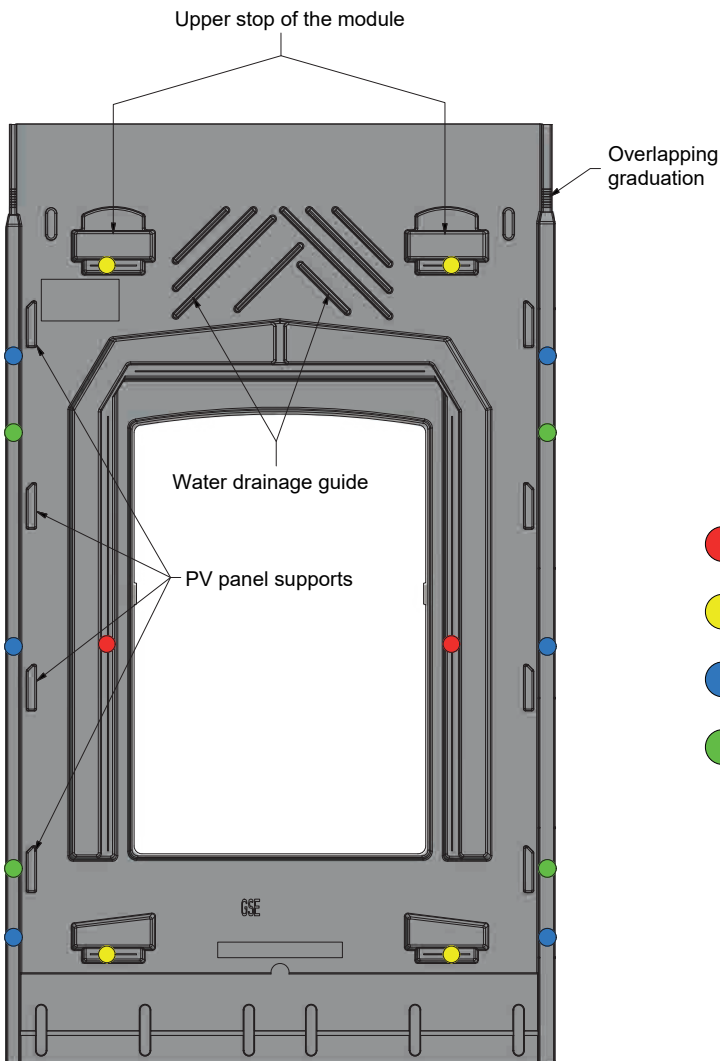

- Frame fixation (no pre-drilling)
- Frame fixation (10 mm pre-drilling)
- Clamps fixation (6 clamps) (10 mm pre-drilling)
- Clamps fixation (4 clamps) (10 mm pre-drilling)

### Portrait frame references – Module sizes



↔ Height tolerance

↔ Width tolerance

		Module tolerances				
		Height		Width		
Réf.		MIN.	MAX.	MIN.	MAX.	
<b>PORTRAIT</b>	<b>Version 2012</b>	1580_808	1540	1620	798	808
		1575_1046	1535	1615	1037	1046
		1575_1053	1535	1615	1044	1053
		1575_1082	1535	1615	1073	1082
		1640_992	1600	1680	983	992
		1640_1001	1600	1680	992	1001
		1640_1001_33	1600	1680	992	1001
		1686-1700_1016	1646	1726	1007	1016
<b>Version 2020</b>	1710_1000	1670	1750	995	1000	
	1710_1005	1670	1750	1000	1005	
	1710_1020	1670	1750	1015	1020	
	1710_1025	1670	1750	1020	1025	
	1710_1030	1670	1750	1025	1030	
	1710_1050	1670	1750	1045	1050	
	1710_1060	1670	1750	1055	1060	

# 1. Kit Presentation

## 1.4 GSE LANDSCAPE Frame

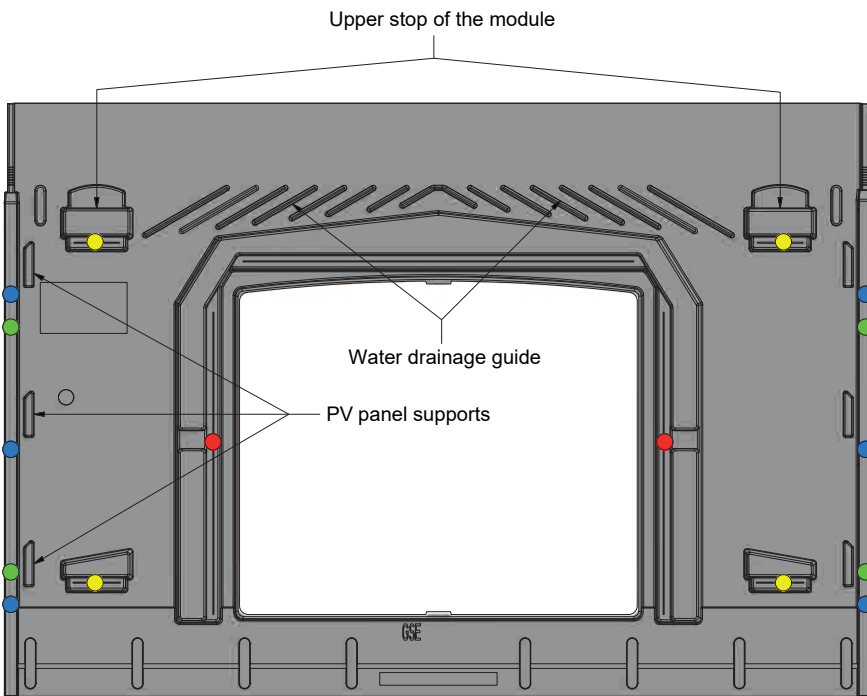

- Frame fixation (no pre-drilling)
- Frame fixation (10 mm pre-drilling)
- Clamps fixation (6 clamps) (10 mm pre-drilling)
- Clamps fixation (4 clamps) (10 mm pre-drilling)

### Landscape frame references – Module sizes

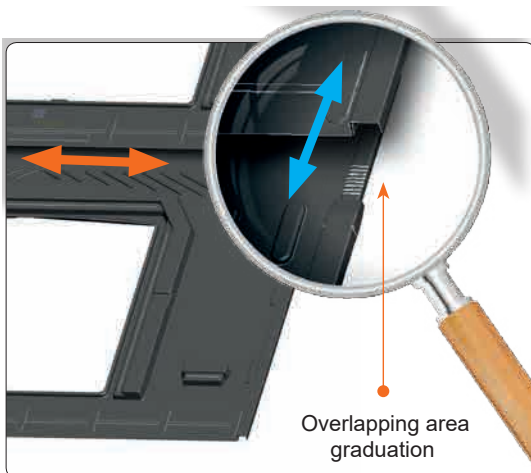

↕ Height tolerance    ↔ Width tolerance

		Réf.	Module tolerances			
			Height	Width		
			MIN.	MAX.	MIN.	MAX.
LANDSCAPE	Version 2012	1559_1082	1042	1122	1550	1559
		1575_1082	1042	1122	1566	1575
		1580_808	768	848	1571	1580
		1640_992	952	1032	1631	1640
		1650_992	952	1032	1641	1650
		1660_992	952	1032	1651	1660
		1670_992	952	1032	1661	1670
		1675_992_33	952	1032	1666	1675
		1680_992	952	1032	1671	1680
		1686_1016	952	1032	1677	1686
		1700_1016	952	1032	1691	1700
Version 2020	1665_1020	980	1060	1660	1665	
	1675_1020	980	1060	1670	1675	
	1680_1020	980	1060	1675	1680	
	1685_1020	980	1060	1680	1685	
	1690_1020	980	1060	1685	1690	
	1700_1020	980	1060	1695	1700	
	1740_1020	980	1060	1735	1740	

# 1. Kit Presentation

## 1.5 Tools required

### ◆ CHALK LINE



### ◆ HAMMER



### ◆ SCREWDRIVER



### ◆ AVIATION SNIP



### ◆ DRILL BITS

- WOOD / METAL DRILL BIT Ø 10mm



- HEX BIT Ø 8mm



### ◆ RIVET GUN



### ◆ MEASURING TAPE



### ◆ WHITE MARKER



### ◆ PENCIL



### ◆ INSTALLATION VIDEO GUIDES

PLEASE FIND ALL OUR INSTALLATION VIDEO GUIDES ON YOUTUBE :

#### GSE IN-ROOF SYSTEM



#### GSE AIR'SYSTEM

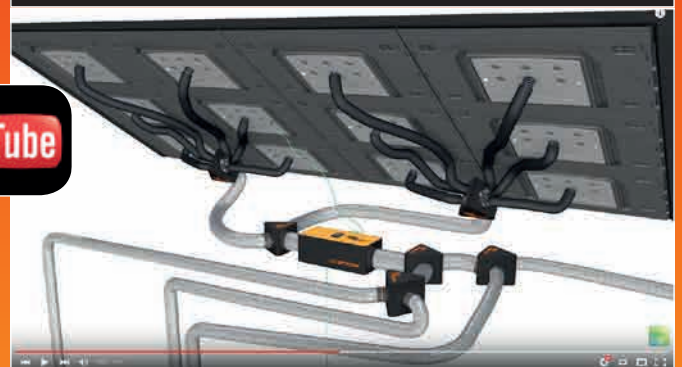

YouTube



# 2. Building site preparation

The installer must proceed to a measurement work beforehand, in order to guarantee the durability and performance of the PV array installed. Climatic conditions of the project (ie. wind and snow<sup>1</sup>) and PV array layout should be considered according to current regulations (Eurocodes and BS 5534).

This data will help **check if the system is suitable for the project conditions**. The thickness of the support battens must be adapted to the roof battens to ensure the junction with the roof covering is watertight.

## 2.1 Climatic Conditions

### Climatic load according to Eurocode 1 and BS 5534 :



Geographical wind zone	Wind speed (m/s)	Design Wind Pressure (kN/m <sup>2</sup> )
1	22	0,820
2	24	0,975
3	26	1,150
4	28	1,330
5	30	1,600

Maximum design wind uplift resistance : **1,88 kN/m<sup>2</sup>**  
*(According to MCS 012 BBA 0156 certificate)*

## 2.2 Location on the roof

The location of the PV array has an influence on the wind load value whether it is in the center, on the edge or in the corner of the roof. The worst case should be taken into account.

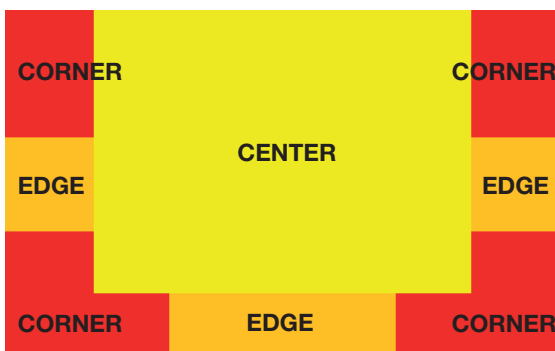

EAVES

*Two-sloped roof*

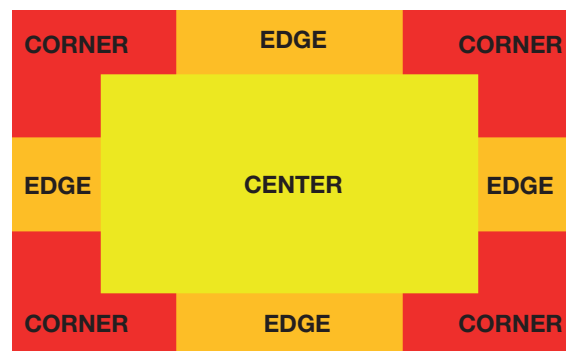

EAVES

*One-sloped roof*

<sup>1</sup> The seismic resistance of the GSE In-Roof System is validated on the whole European territory. This criterion is not to be taken into account.

## 2. Building site preparation

### 2.3 Determine wind pressure of the project

To calculate the wind load on the PV array, you need to priorly know the following parameters:

- Location of the project
- Altitude
- Type of terrain
- Distance from the shoreline
- Ridge height
- Roof pitch
- Roof zone (Center, Edge, Corner)

Ideally, climatic load (and especially wind load) should be calculated for each project, but you can refer to the tables below, if all conditions matches with those of the project.

#### Fixed conditions :

- Terrain category : **Country terrain** (including Town Terrain)
- Distance from the shoreline : **10 km**
- Battens dimension : **25 x 50mm**

#### 1<sup>st</sup> case : Roof pitch $\geq 25^\circ$

Ridge Height	Location on the Roof	Zone 1 (Alt $\leq 250m$ )	Zone 2 (Alt $\leq 200m$ )	Zone 3 (Alt $\leq 130m$ )	Zone 4 (Alt $\leq 100m$ )	Zone 5 (Alt $\leq 50m$ )
6 m	Center	1,26 kN	1,38 kN	1,44 kN	1,58 kN	1,65 kN
	Edges	1,46 kN	1,60 kN	1,67 kN	1,83 kN	1,92 kN
	Corners	1,56 kN	1,72 kN	1,78 kN	1,96 kN	2,05 kN
8 m	Center	1,37 kN	1,51 kN	1,57 kN	1,72 kN	1,80 kN
	Edges	1,59 kN	1,75 kN	1,82 kN	2,00 kN	2,09 kN
	Corners	1,71 kN	1,87 kN	1,95 kN	2,14 kN	2,24 kN
10 m	Center	1,43 kN	1,57 kN	1,63 kN	1,79 kN	1,88 kN
	Edges	1,66 kN	1,82 kN	1,90 kN	2,08 kN	2,18 kN
	Corners	1,78 kN	1,95 kN	2,03 kN	2,23 kN	2,33 kN

#### 2<sup>st</sup> case : Roof pitch $\geq 35^\circ$

Ridge Height	Location on the Roof	Zone 1 (Alt $\leq 250m$ )	Zone 2 (Alt $\leq 200m$ )	Zone 3 (Alt $\leq 150m$ )	Zone 4 (Alt $\leq 100m$ )	Zone 5 (Alt $\leq 50m$ )
6 m	Center	1,09 kN	1,19 kN	1,29 kN	1,36 kN	1,43 kN
	Edges	1,36 kN	1,49 kN	1,61 kN	1,71 kN	1,78 kN
	Corners	1,43 kN	1,57 kN	1,69 kN	1,79 kN	1,87 kN
8 m	Center	1,19 kN	1,30 kN	1,40 kN	1,49 kN	1,56 kN
	Edges	1,48 kN	1,63 kN	1,75 kN	1,86 kN	1,95 kN
	Corners	1,56 kN	1,71 kN	1,84 kN	1,95 kN	2,04 kN
10 m	Center	1,24 kN	1,36 kN	1,46 kN	1,55 kN	1,62 kN
	Edges	1,55 kN	1,69 kN	1,83 kN	1,94 kN	2,03 kN
	Corners	1,62 kN	1,78 kN	1,92 kN	2,04 kN	2,13 kN

# 3. Installation

## 3.1 Preparation of the roof covering

### 3.1.1 Calculation of the PV array dimensions

**INFO:** Download our layout calculator on the « Download & Media » section of our website [www.gseintegration.com](http://www.gseintegration.com) to determine the dimensions of your PV array.

The dimensions of the PV array can be calculated using the GSE frame reference (see sections 1.3 and 1.4 to determine the GSE frame compatible with the module):

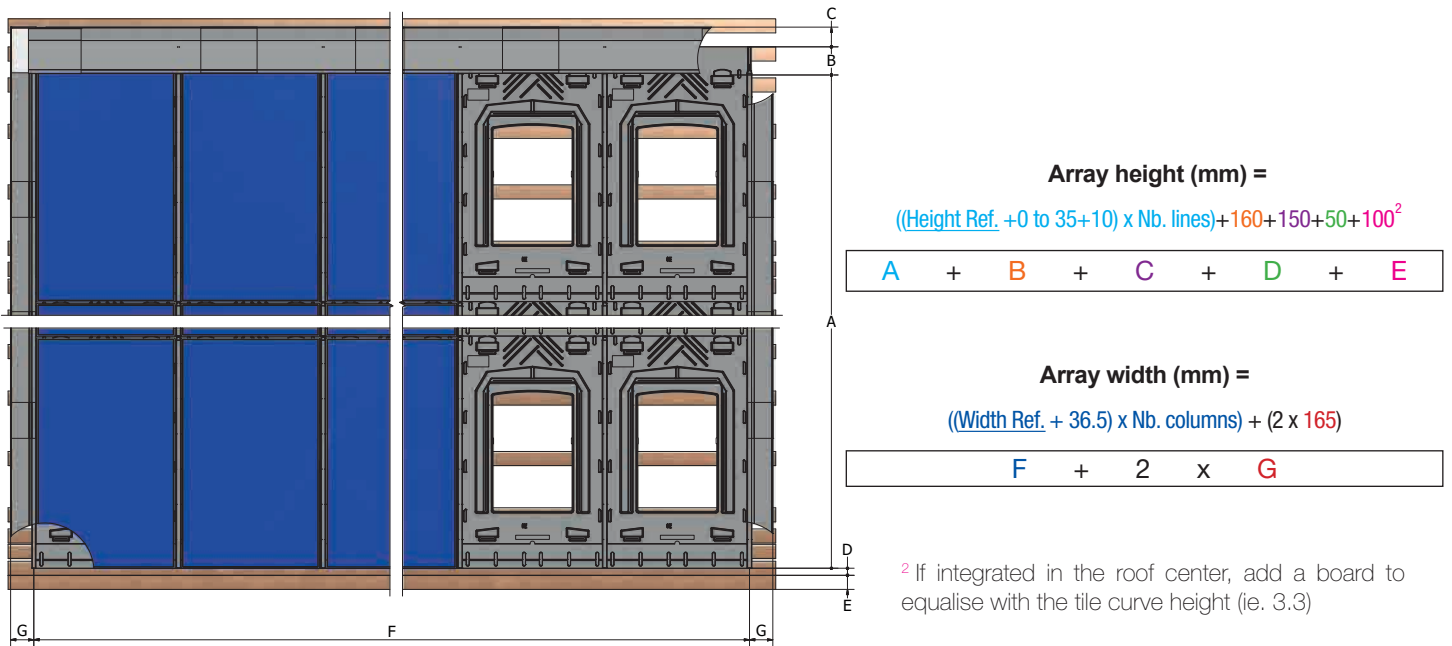

GSE PORTRAIT FRAMES														
Height Réf.	1580	1575	1575	1575	1640	1640	1686	1710	1710	1710	1710	1710	1710	
Width Réf.	808	1046	1053	1082	992	1001	1016	1000	1005	1020	1025	1030	1050	1060

GSE LANDSCAPE FRAMES																	
Height Réf.	1082	1082	992	992	992	992	992	992	992*	992*	1020	1020	1020	1020	1020	1020	
Width Réf.	1559	1575	1640	1650	1660	1670	1675	1680	1686	1700	1665	1675	1680	1685	1690	1700	1740

\* Landscape frames 1686\_1016 and 1700\_1016 have a reference height of 992.

### 3.1.2 Roof cover installation

Remove the roofing elements following the PV array dimensions (calculated beforehand), and by removing 1 or 2 extra tile lines (slate or flat tile) on the lateral sides and top of the array.

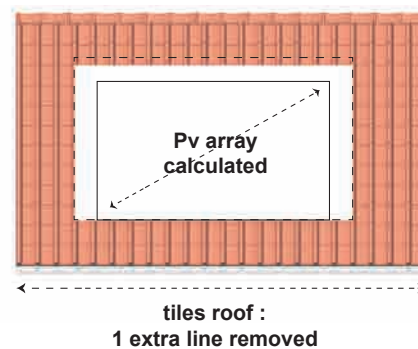
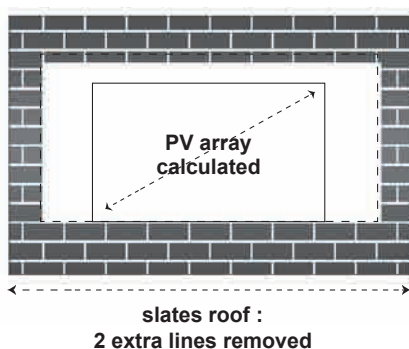

# 3. Installation

## 3.2 Fixation of the support battens

**ATTENTION:** PRIOR TO STARTING ANY WORK, THE INSTALLER MUST ENSURE THAT THE FRAMEWORK IS FLAT AND **THERE MUST** BE A ROOF UNDERLAY ACCORDING TO THE BUILDING STANDARD BS 5534.

1. Determine beforehand the number of fixing clamps and the adapted batten section (see section 2).
2. Dispose the wooden battens to the following locations:
  - Fixing points of the clamps
  - Fixing points of the frames
  - Junction between the frame rows<sup>3</sup>
  - Support of the sealing strip<sup>3</sup>
  - Mounting hooks of top flashings<sup>3</sup>

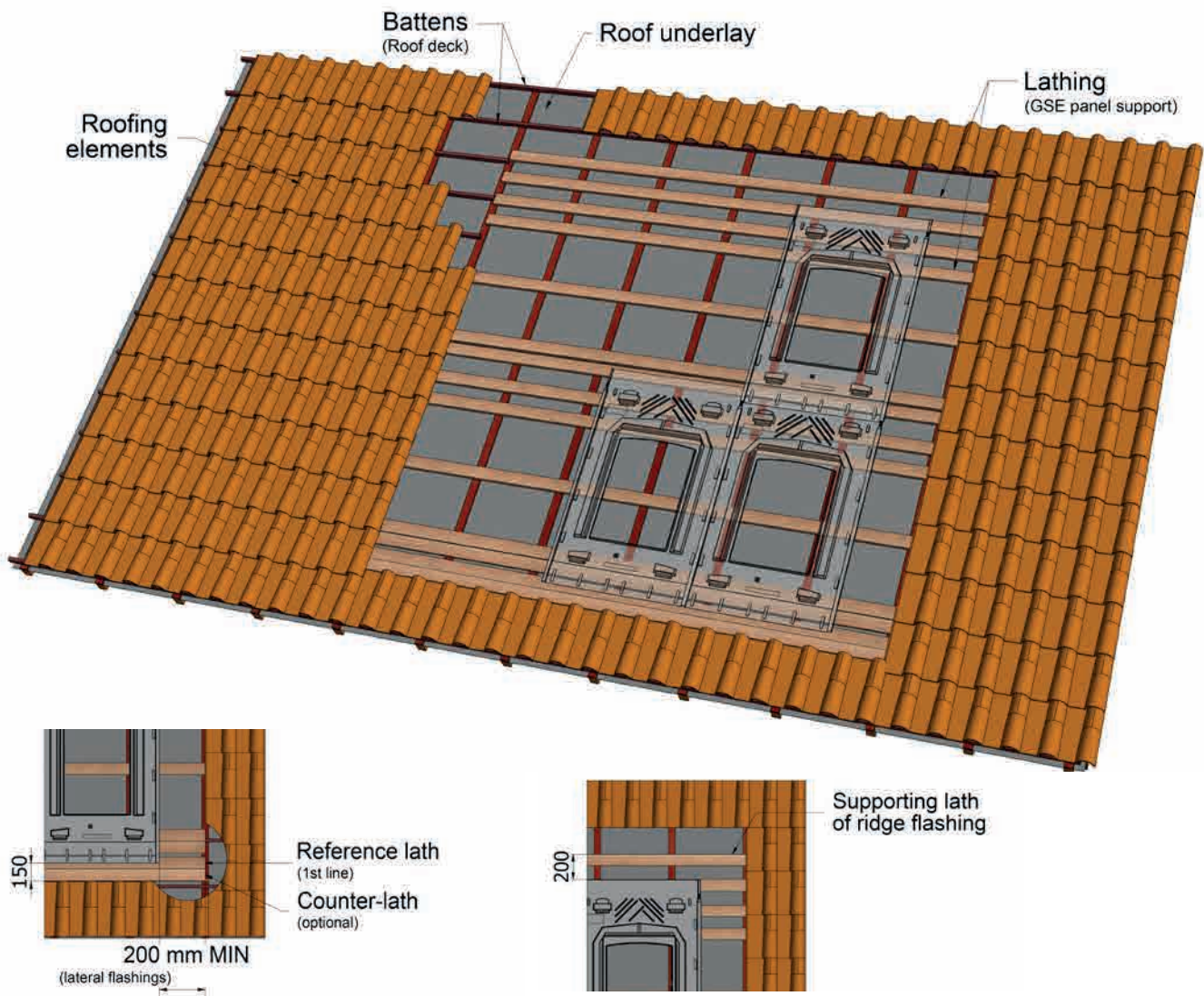

**ATTENTION: THE POSITION OF THE FIXING CLAMPS AND THEIR SUPPORT BATTENS MUST COMPLY WITH MODULE MANUFACTURER REQUIREMENTS.**

<sup>3</sup> Since these elements play no role in the mechanical system strength, the width of the timber could be different from that calculated for the fixing clamps. Only the thickness should be identical.

# 3. Installation

All of our battening plans in PORTRAIT and LANDSCAPE configuration are available on our site [www.gseintegration.com](http://www.gseintegration.com)

**Example of battening plans for PORTRAIT frames with a reference height of 1640 mm and 4 fixing clamps :**

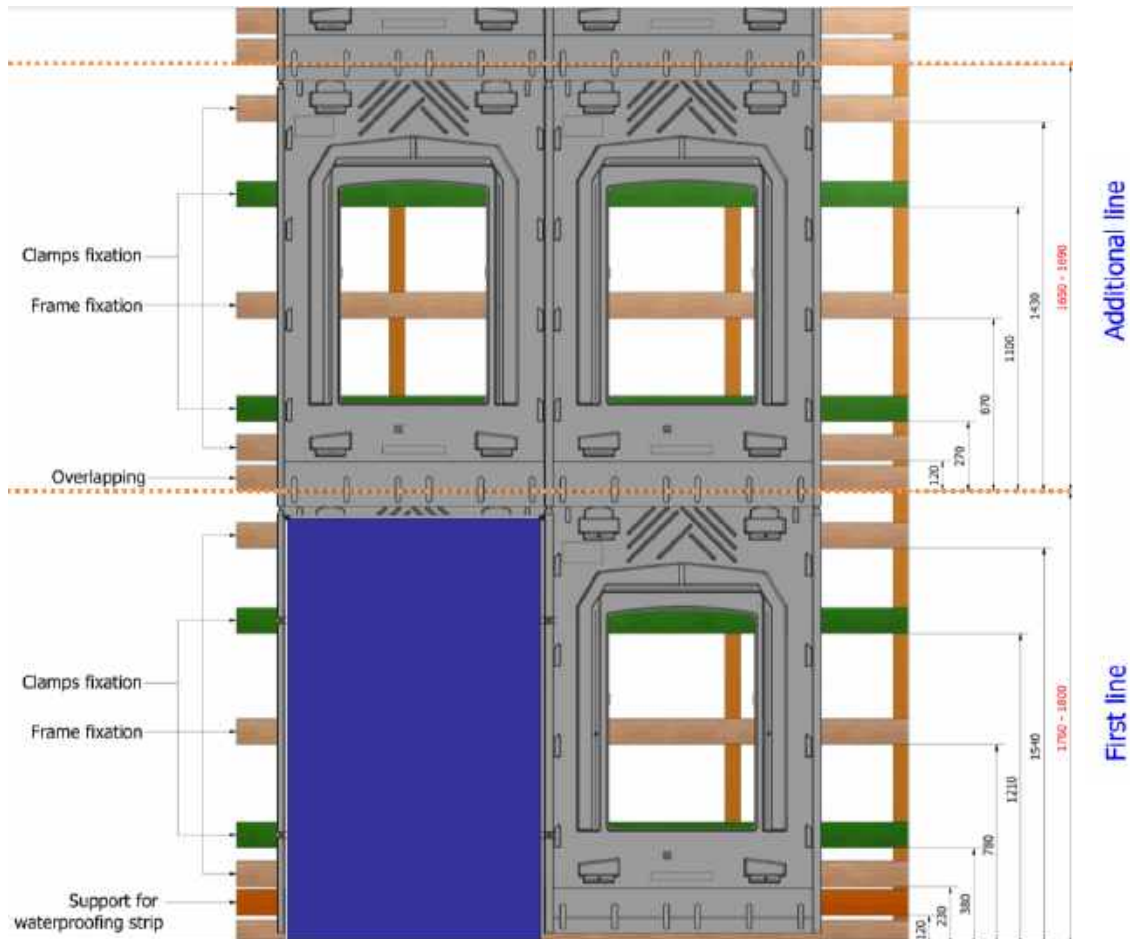

**Example of battening plans for LANDSCAPE frames with a reference height of 992 mm and 4 fixing clamps :**

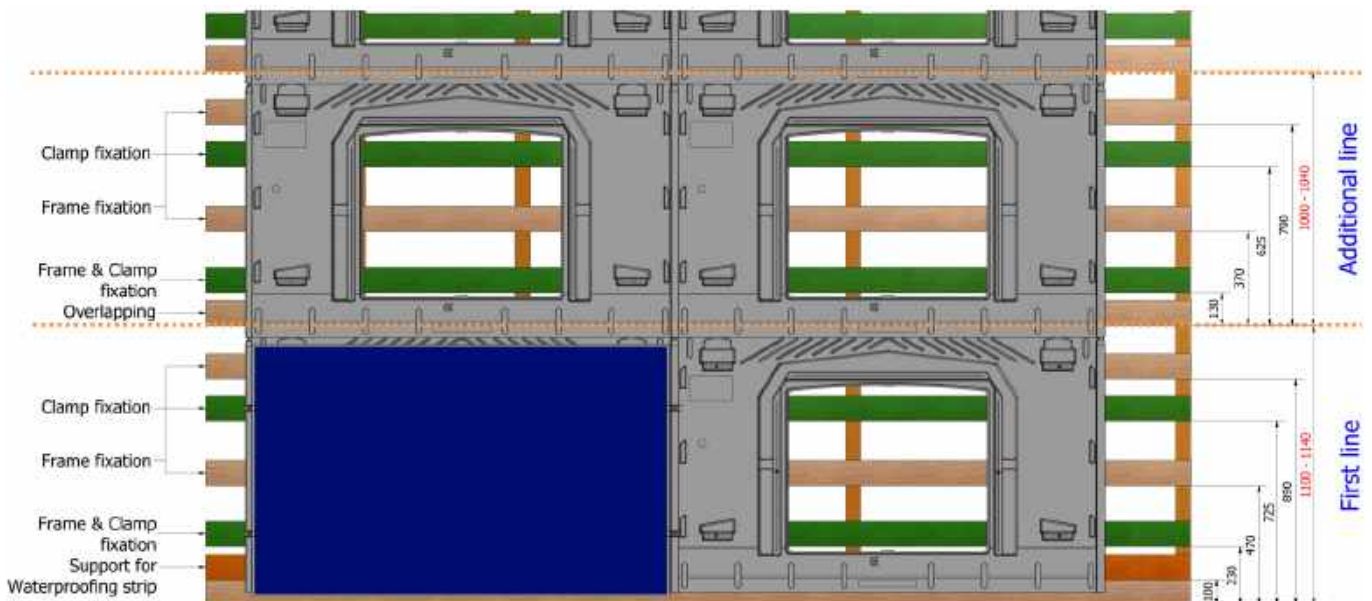

# 3. Installation

## 3.3 Sealing strip installation

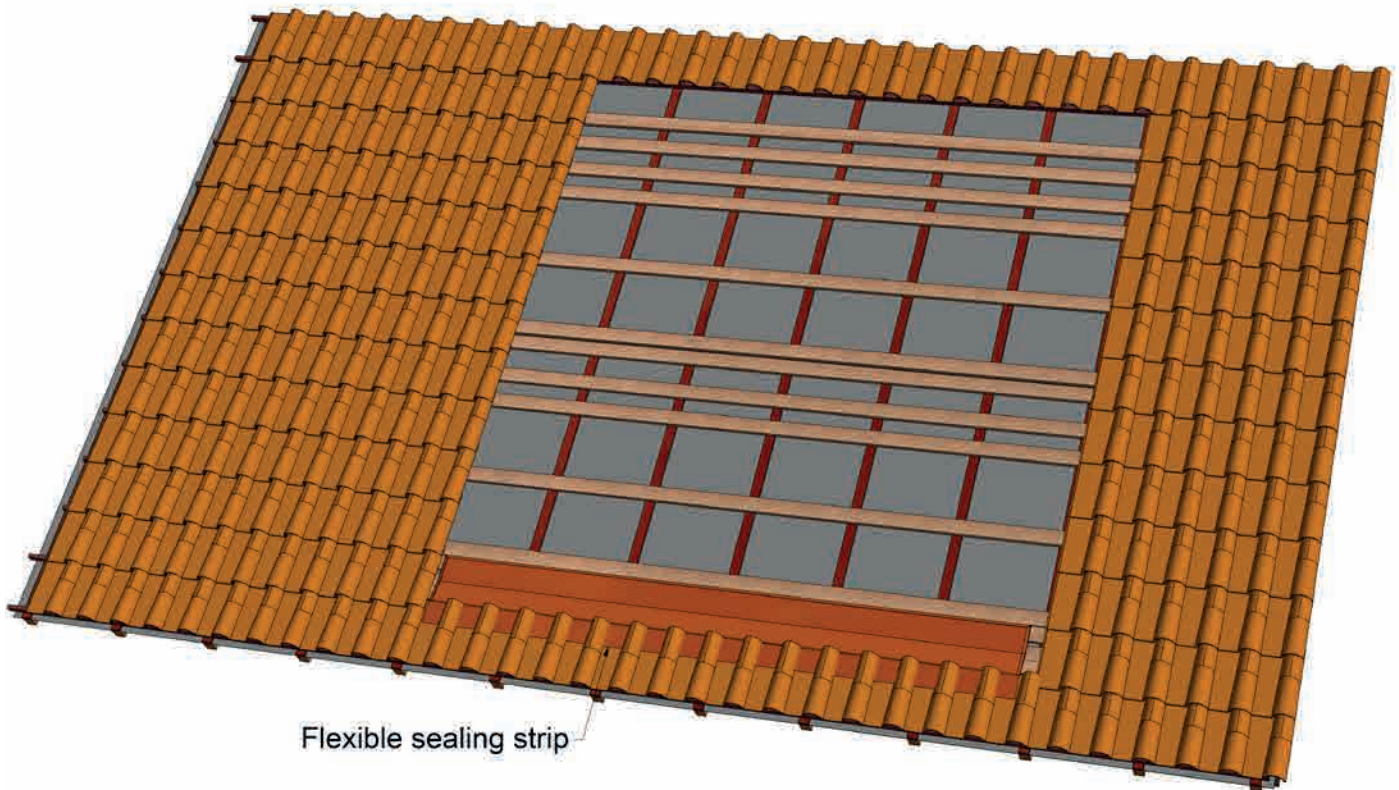

The sealing strip is laid out to link up with the bottom part of the roofing (PV array in the middle of the roofing).

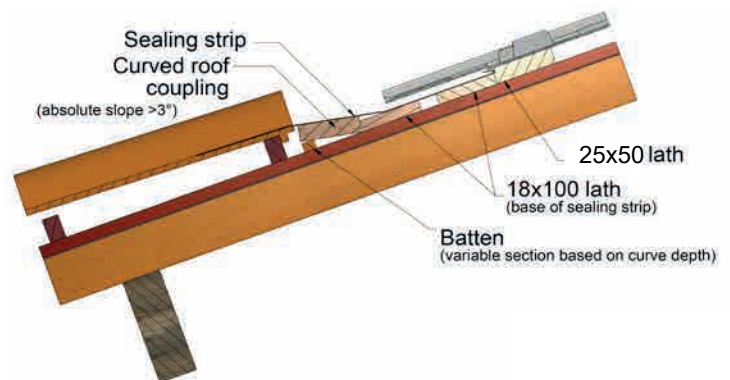
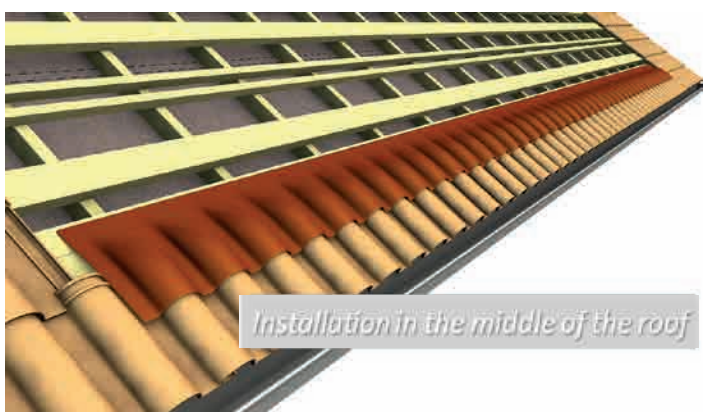

A batten is placed to fit with the thickness of the roof tile and to provide a flat base for the sealing strip.

**ATTENTION:**  
**ALWAYS MAINTAIN A MINIMUM SLOPE OF 3°**

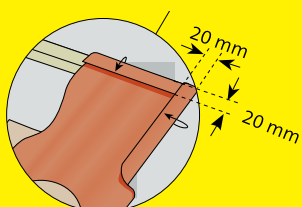

**When installing the sealing strip on tiles with relief, make sure to press it down well so that it follows the roof tile's shape correctly. Make a 20-mm fold on the top part and sides to prevent water upwelling.**

# 3. Installation

When installing all the way to the eaves, the sealing strip is laid out in a way as to connect directly to the gutter.

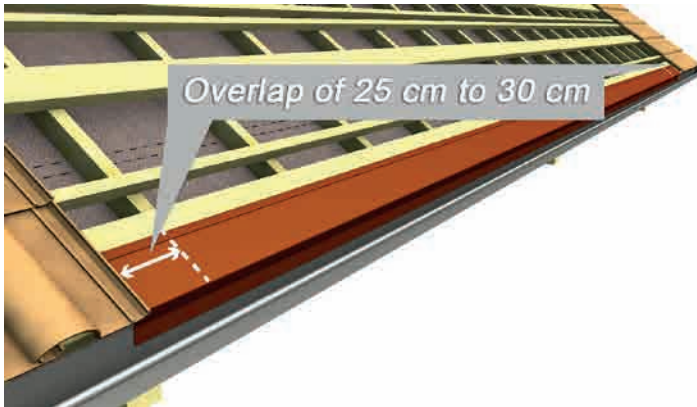

At any rate, the length and the width of the strip should be enough so that the following overlap dimensions are adhered to:

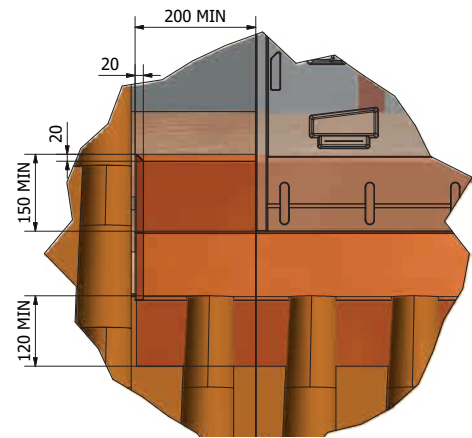

## 3.4 GSE Frames installation

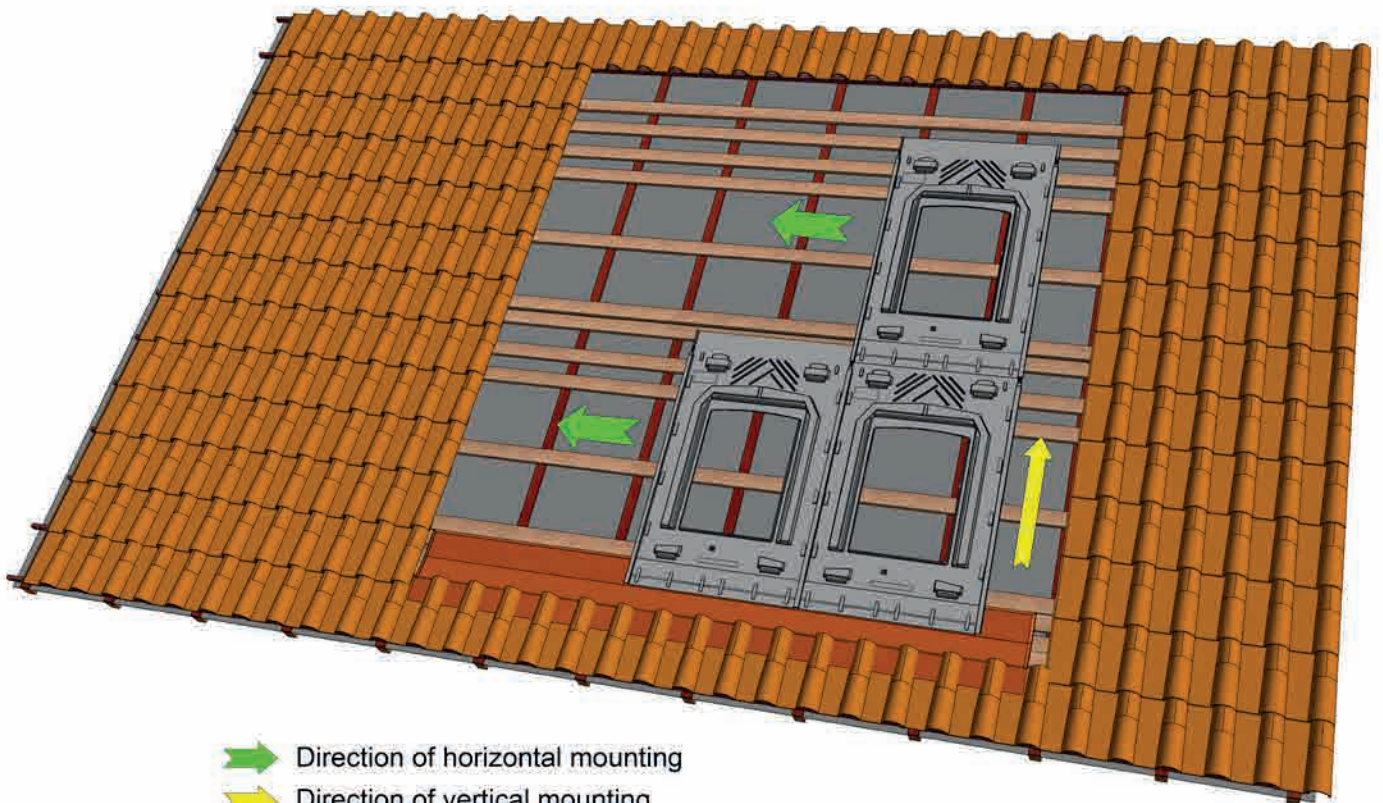

- ➡ Direction of horizontal mounting
- ➡ Direction of vertical mounting

Draw a chalk line along the bottom of the first row, in the middle of the reference lath.

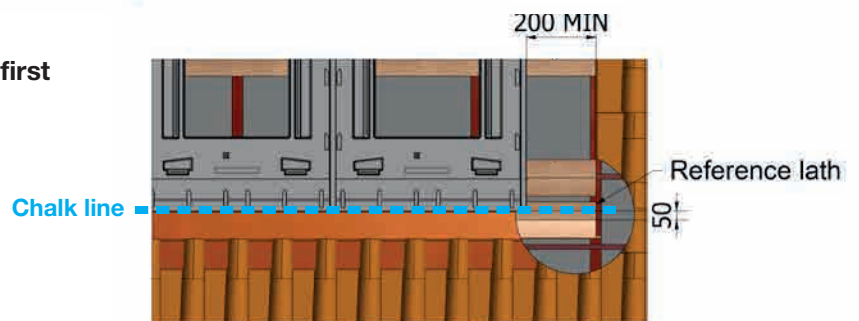

# 3. Installation

Interlock the plastic frames from the right to the left side (left to right is also possible - check that the interlocking is well done)

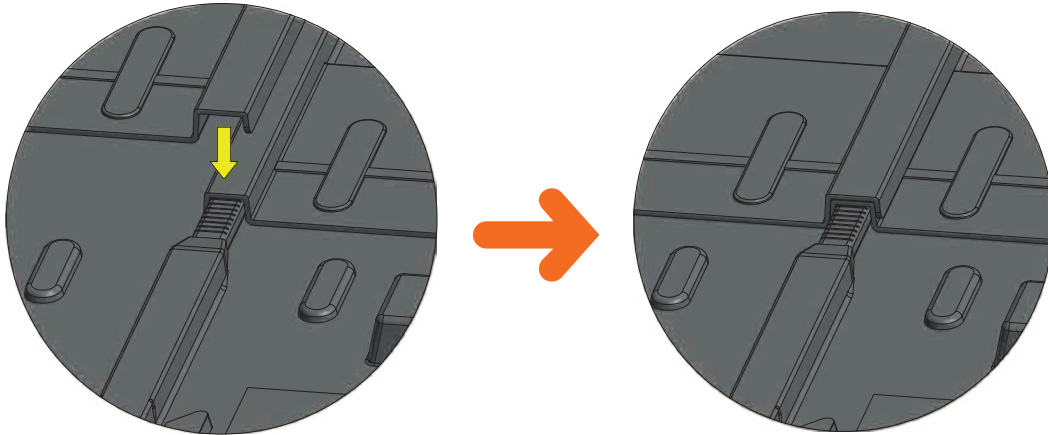

Attach the panels only by the reference points.

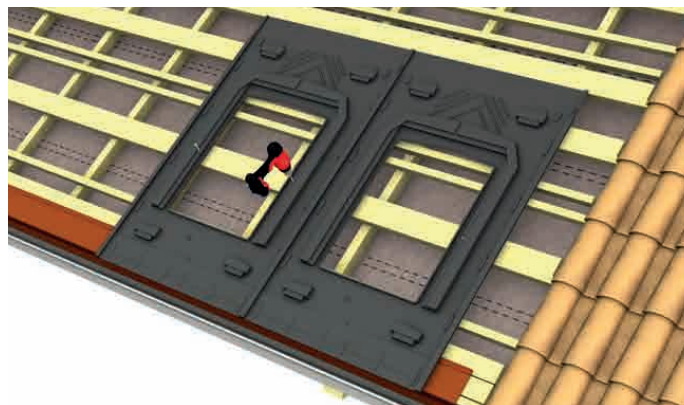

**ATTENTION: WHEN INSTALLING THE SUBSEQUENT ROWS, ADJUST HOW ONE ROW COVERS THE OTHER USING THE SCALE BASED ON THE LENGTH OF THE MODULE (CF DEVICE).**





# 3. Installation

## 3.5 Lateral flashings installation

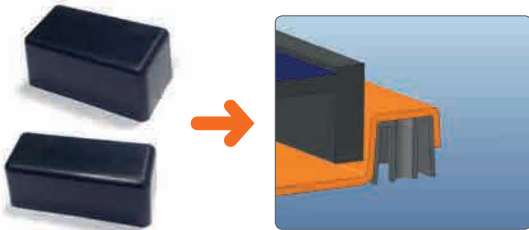
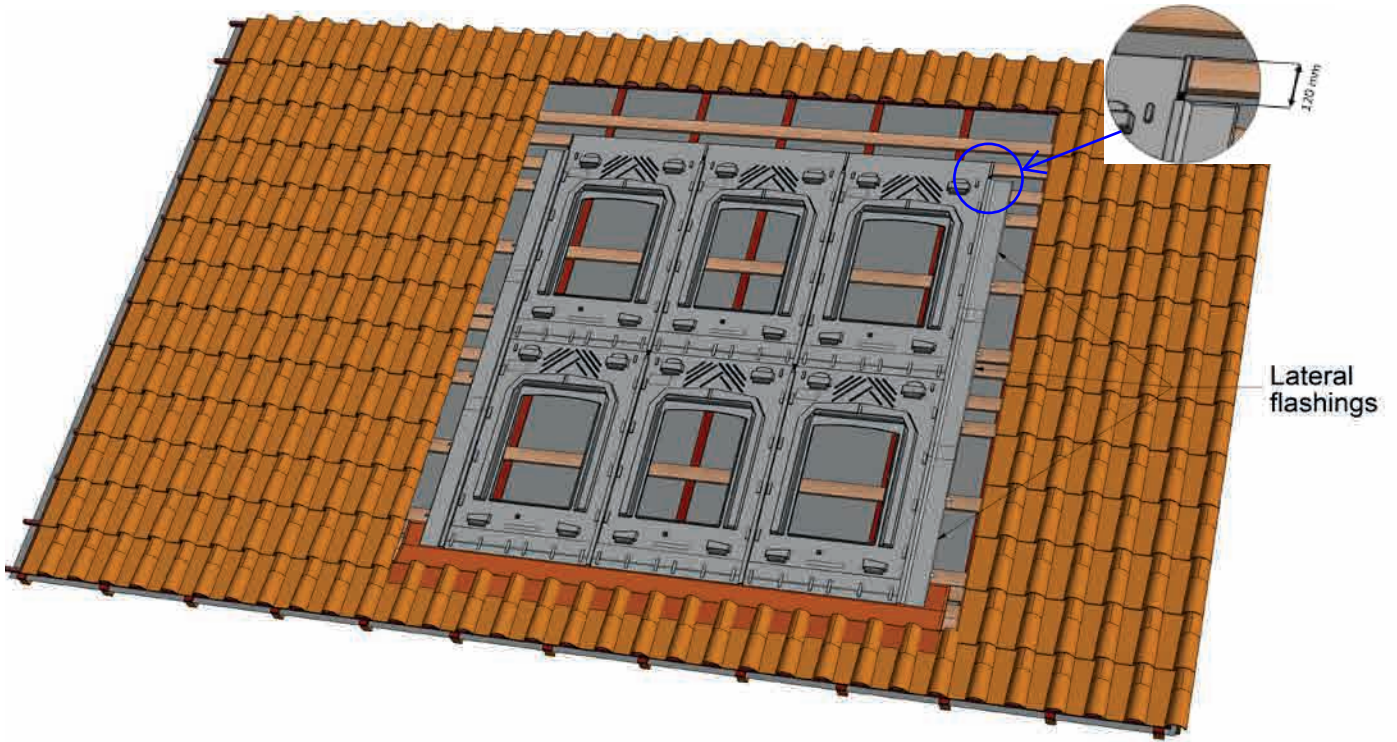

**ATTENTION:**  
BEFORE INSTALLING THE LATERAL FLASHINGS, MAKE SURE TO PLACE THE WEDGES AT THE ARRAY ENDS, UNDER THE CORRUGATIONS, WHERE THE END CLAMPS ARE LOCATED.

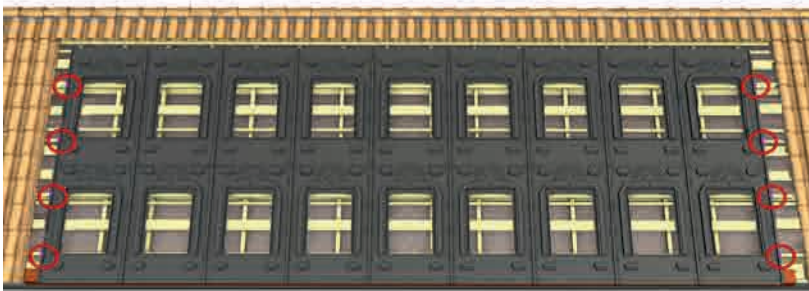

**TIP:**  
Mark their position on the inner surface of the panel to identify them after positioning the lateral flashings.

- Place the lateral flashings of the low end of the first row of panels, up to 120 mm of the upper edge of the last row. The overlap between two parts of the lateral flashing will be at least 150 mm. Each will be held in place by at least 2 attachment hooks.

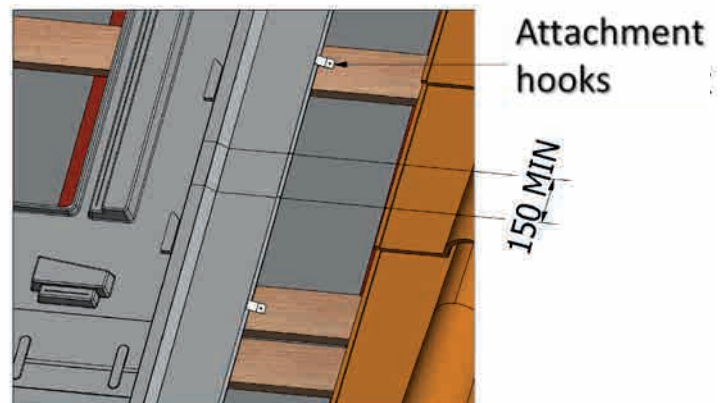

# 3. Installation

- Carry out the pre-drilling using a 10 mm wooden drill bit on the 4 remaining attachment points of the GSE frame.

Tip: It is possible to pre-drill the expanding points of the frame before mounting on the roof. The frames are drilled individually (do not drill several frames at the same time).

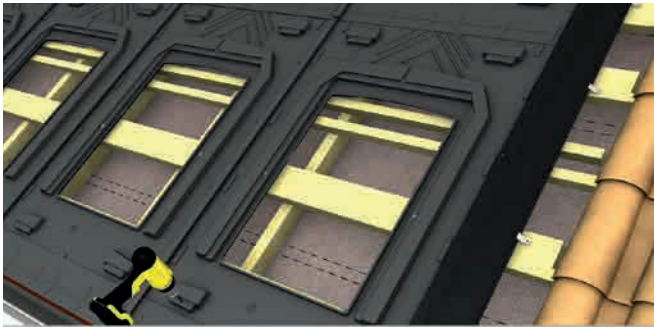

Pre-drilling of frames: 4 attachment points

- Screw the 4 attachment points of the frame.

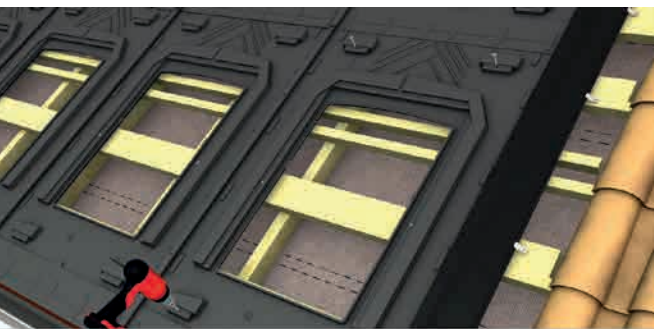

Screwing of GSE frames

- Then, pre-drill the fixing points of the clamps.



- For end clamps, pre-drill through the flashing, the frame's corrugation and the wedges.



Pre-drilling of GSE frames + flashings + edge wedges

## Reminder:

It is prohibited to drill in the outflow zones and at the high points of the GSE frame. It may compromise the integrity of the photovoltaic system and its watertightness.

Please refer to the plans page 6 & 7 for the location of the fixing points.

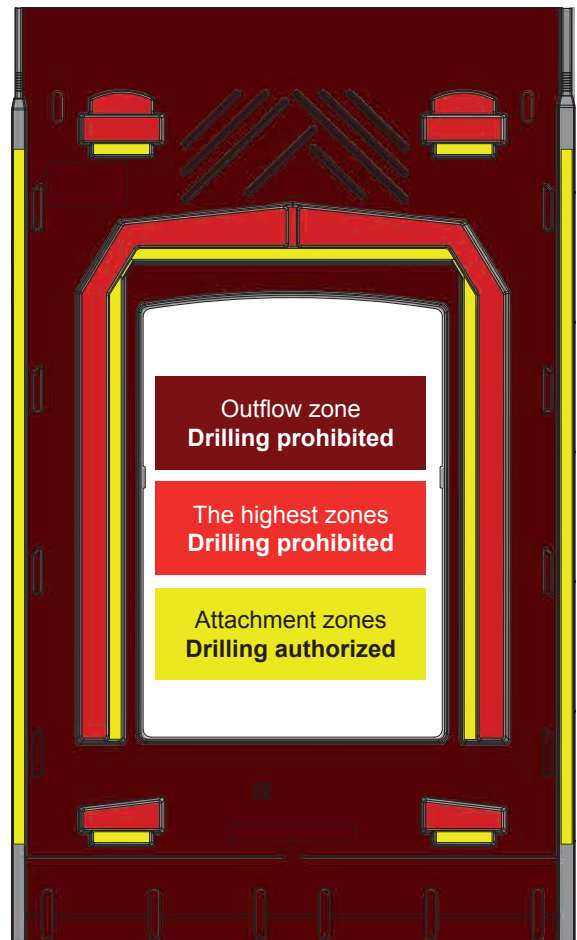
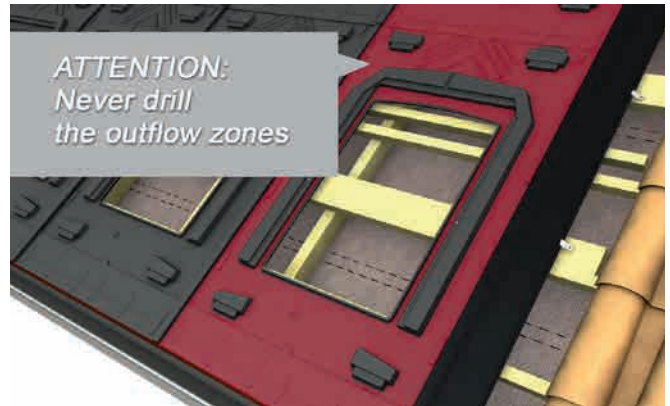

# 3. Installation

## 3.6 PV modules installation

### 3.6.1 Cabling preparation

Example of wiring diagram with installation of micro-inverters:

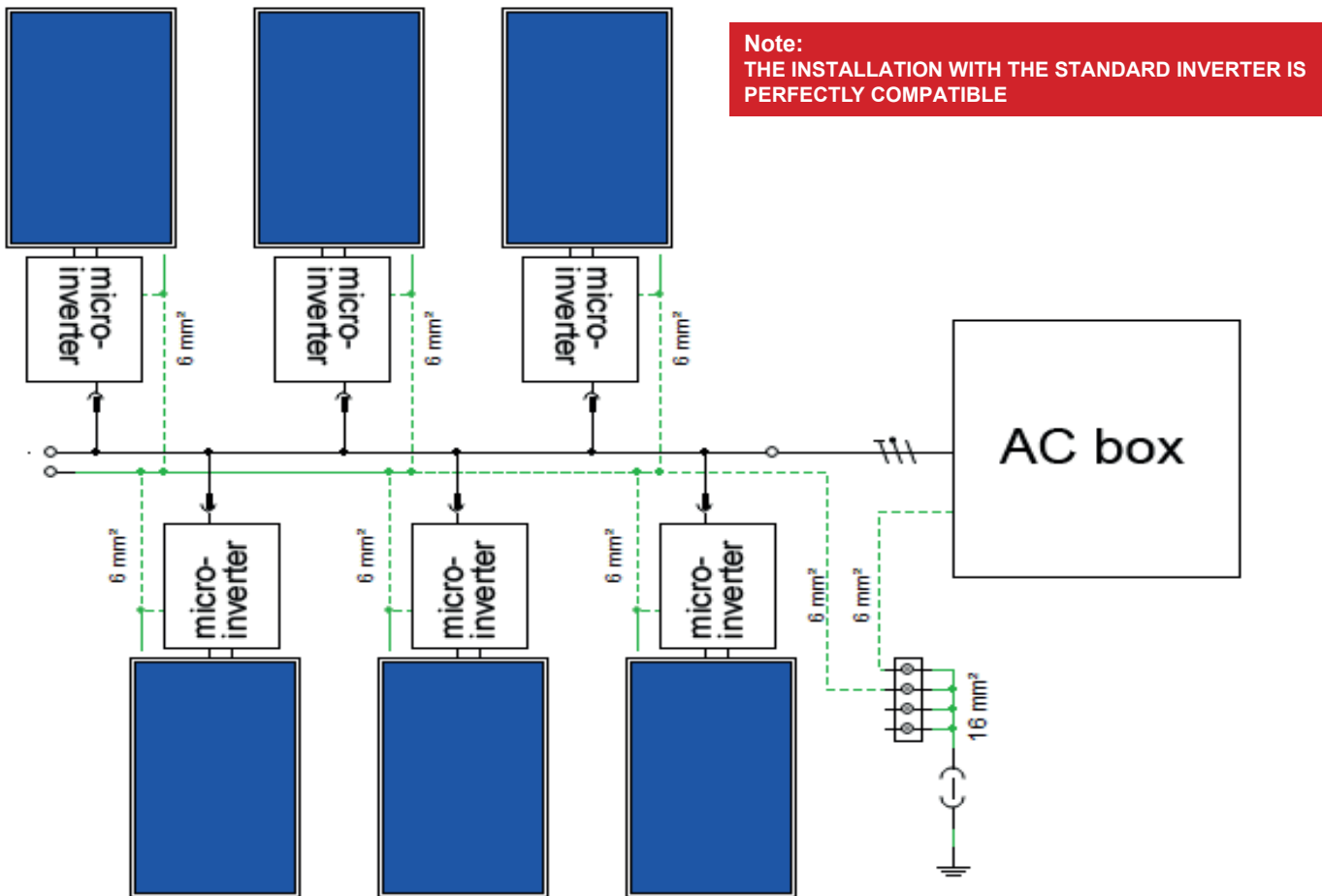

Position the module in such a way that the cables of the junction box pass through the designated space.

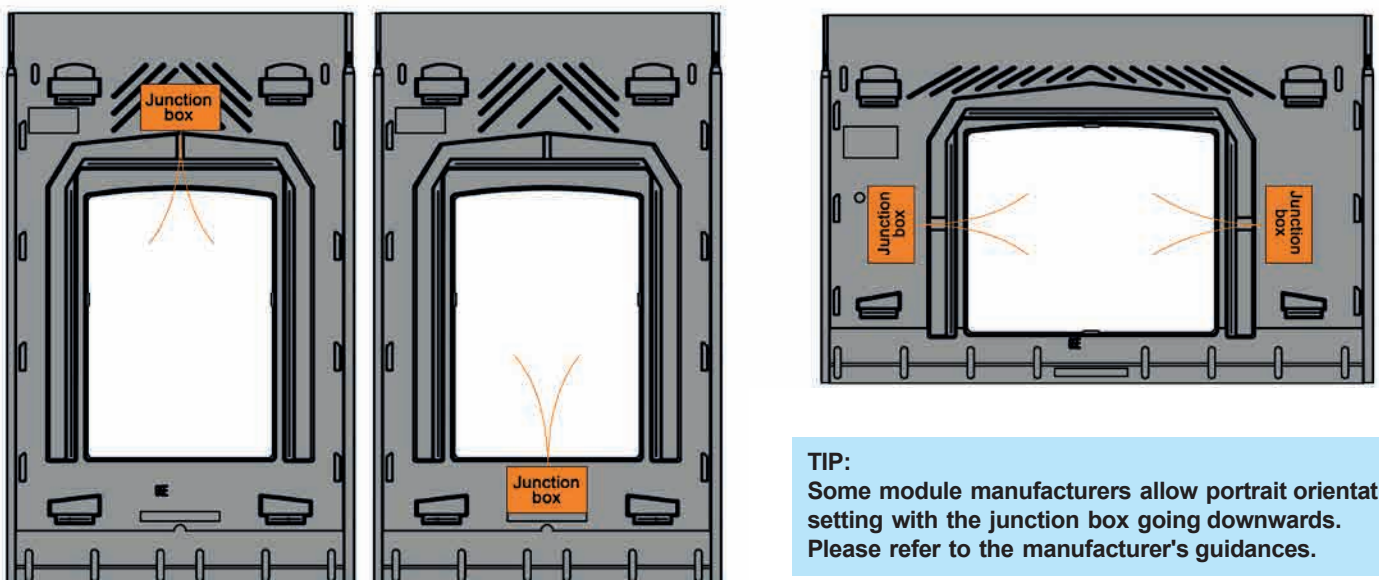

# 3. Installation

When using micro-inverters, attach them to a lath at the level of the GSE frame's central hole.

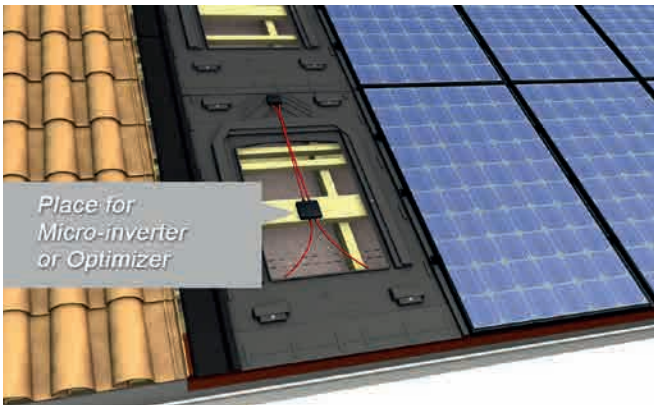

**ATTENTION:** PLEASE REFER TO THE INVERTER'S MANUAL TO BE SURE THAT THE INSTALLATION COMPLY WITH THE MANUFACTURER RECOMMENDATIONS

✓ **Authenticated compatibility for:**



Passage of grounding cables:

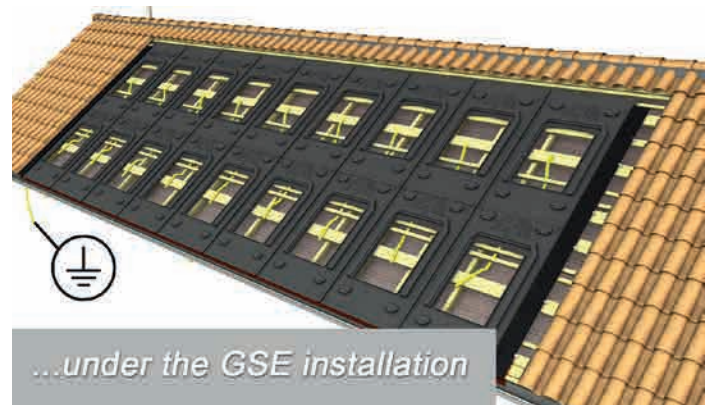
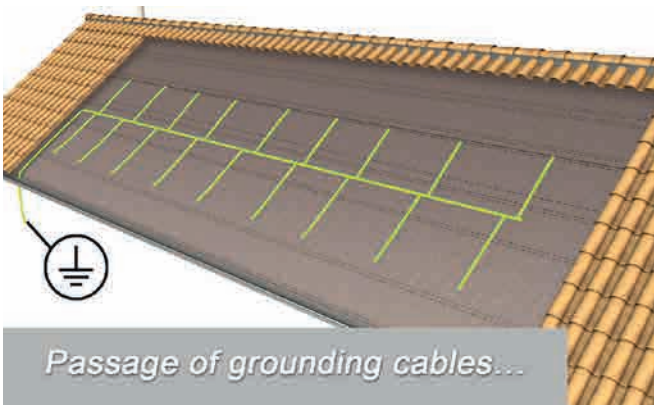

**ATTENTION:** WHEN SETTING UP THE CABLES, MAKE SURE YOU DO NOT CREATE ANY INDUCTION LOOP, IN ACCORDANCE WITH REGULATION.

Grounding of the frame of the modules and of the micro-inverter (please refer to the implementation requirements of manufacturers) :



**ATTENTION:** MAKE SURE THAT ALL CABLE PASSAGES ARE KEPT ON THE FRAME USING CABLE CLAMPS.

# 3. Installation

## 3.6.2 Fixation of the PV module

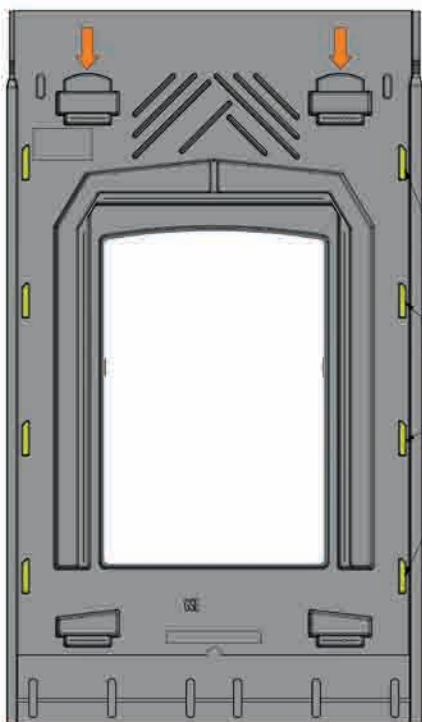
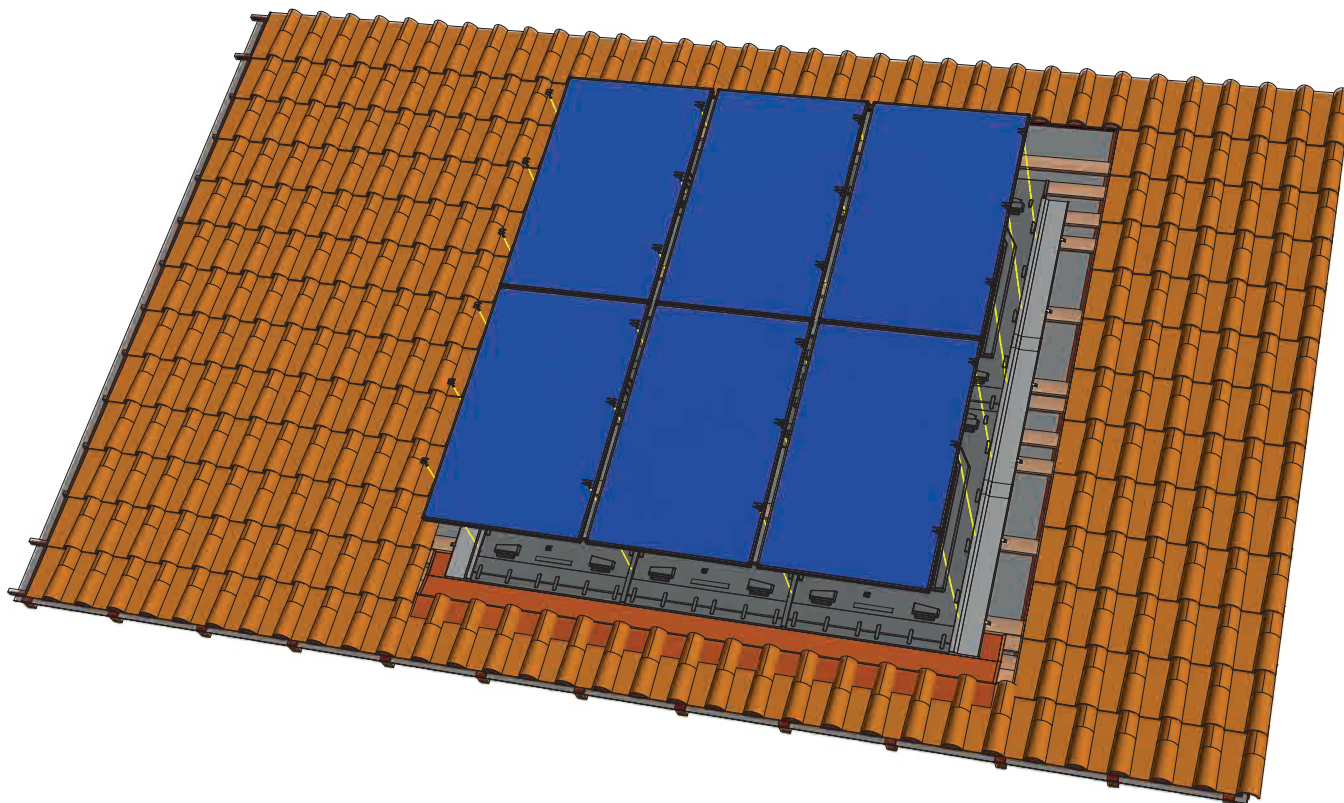

Position the modules in such a way that they're resting on the support pads (yellow) and abut against the upper pads (orange arrows).

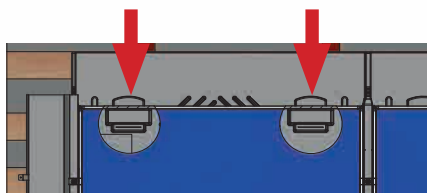
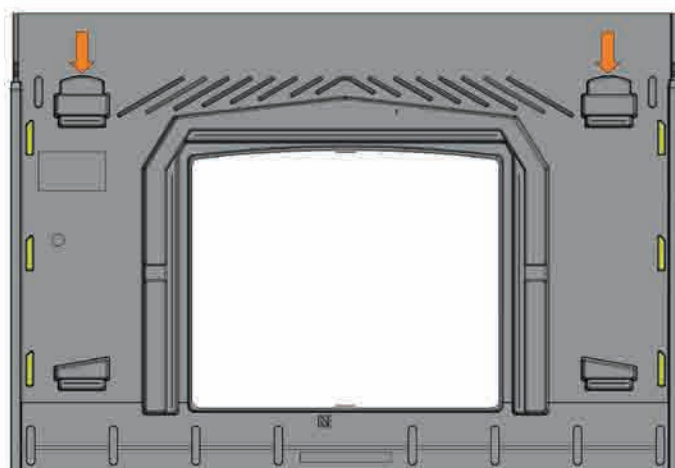

**ATTENTION:**  
CHECK THAT THE MODULES ARE WELL CENTERED IN RELATION TO THE FRAME SO THAT THE GRIP OF THE CLAMPS IS THE SAME ON BOTH SIDES.  
THE MODULE FRAME MUST ABUT AGAINST THE UPPER PADS OF THE PANEL TO PREVENT SHIFTING.

# 3. Installation

Stick the EPDM foam under the clamps and pre-drill them, by screwing and unscrewing to remove material.

**ATTENTION:**  
CHECK THAT BENEATH THE CLAMP IS DRY AND HAS NO DIRT TO ENSURE OPTIMAL BONDING OF THE FOAM.



Sticking of the EPDM foam under the fixing clamp



Pre-drilling of the EPDM foam

Attach the modules by screwing the fixing clamps at the designated positions.

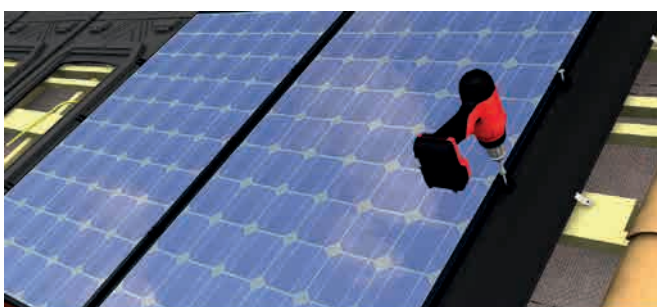
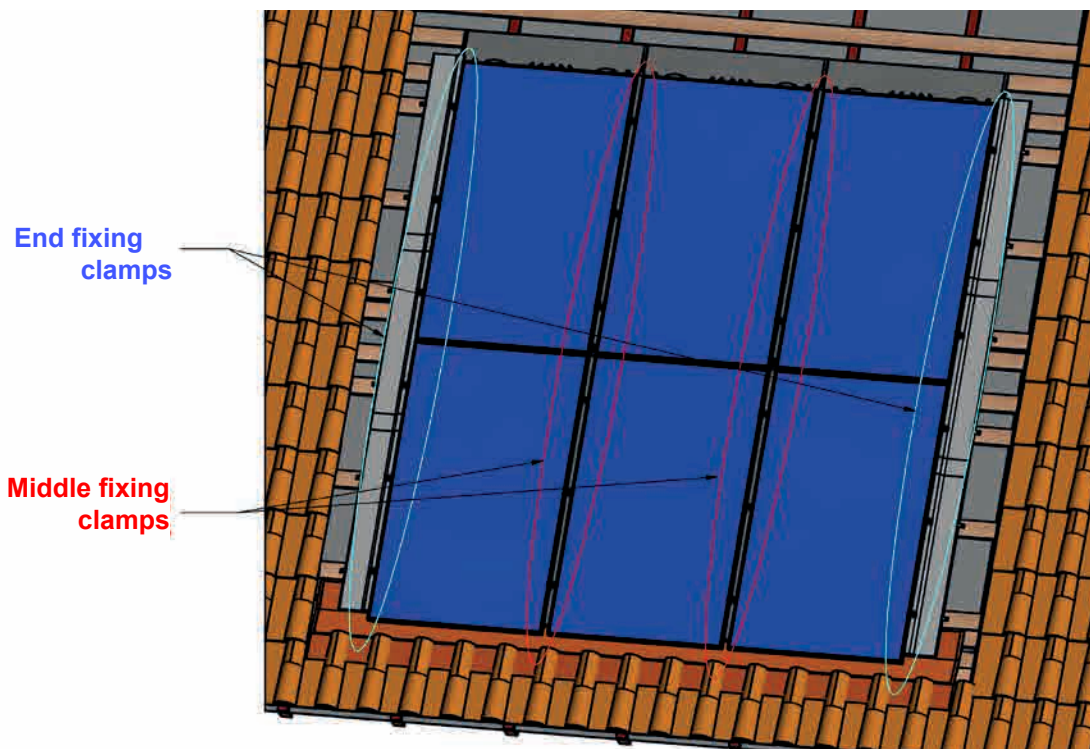

Installation of the end fixing clamps

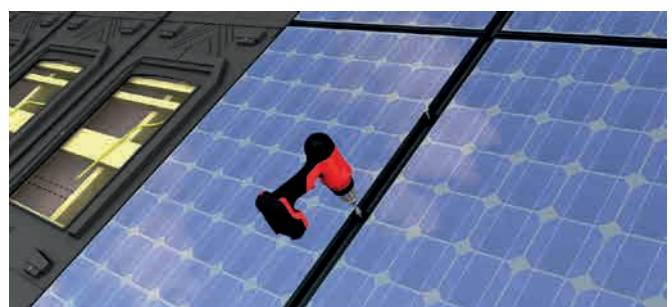

Installation of the middle fixing clamps

# 3. Installation

## 3.7 Top flashings installation

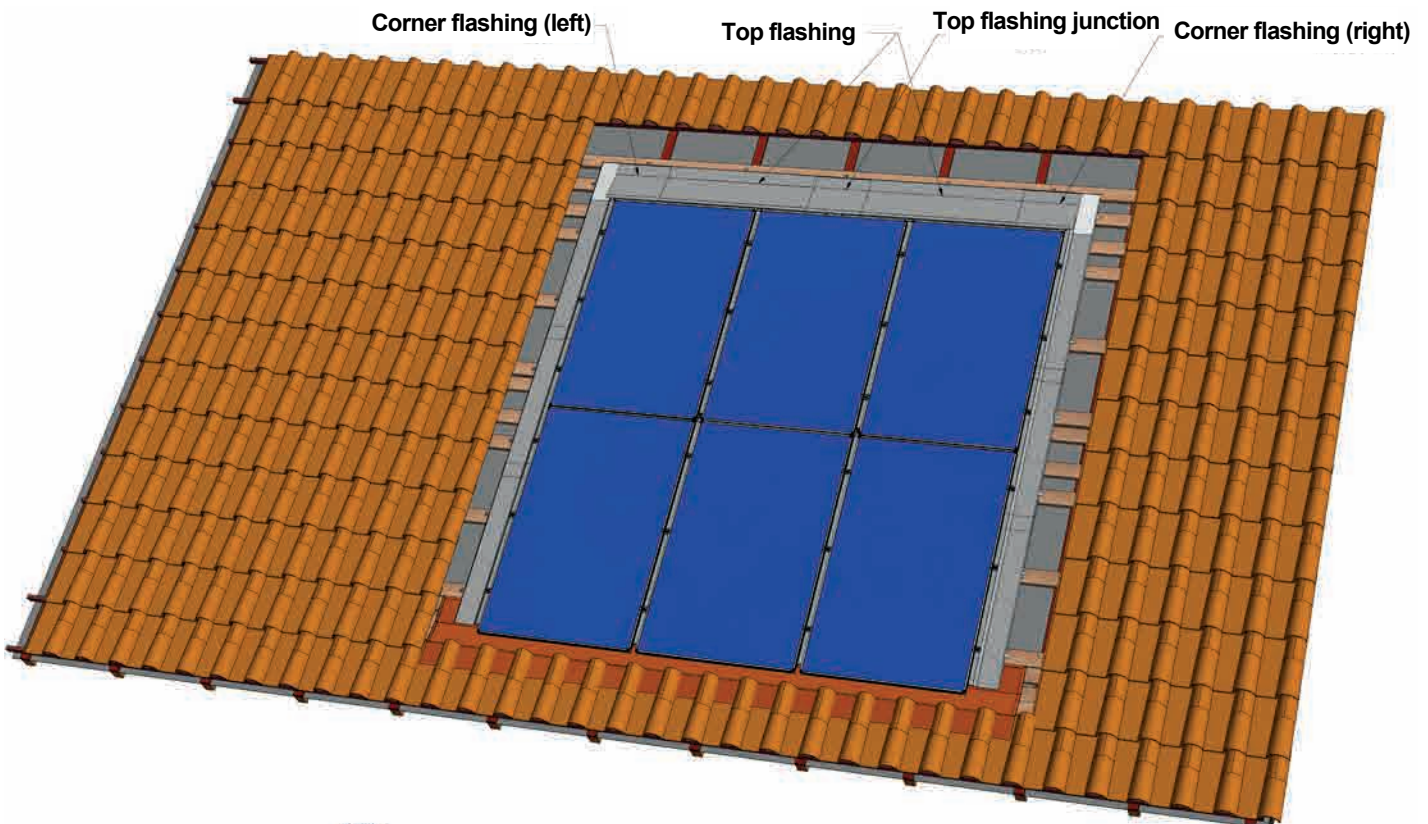

**ATTENTION:**

THE TOP FLASHING PIECE IS DESIGNED WITH A SLOPE OF 14° TO ALLOW WATER FLOW ABOVE THE UPPER ROW OF MODULES. IT IS THEREFORE, ESSENTIAL FOR THE INSTALLER TO ENSURE THAT THE ROOF SLOPE IS SUFFICIENT TO PREVENT WATER STAGNATION ACCORDING TO THE REGULATION.

IN BORDERLINE CASES, WE RECOMMEND THAT YOU EITHER USE A THICKER SUPPORT LATH TO DECREASE THE COUNTER-SLOPE OR TO REPLACE THE TOP FLASHINGS WITH A FLEXIBLE FLASHING STRIP (SEE BELOW).

Join the top flashings and the attach angle using pop rivets, taking care that you adjust the module frame thickness.



# 3. Installation

Position the assembly so that the module frame thickness fits between the attach angle and the top flashing.

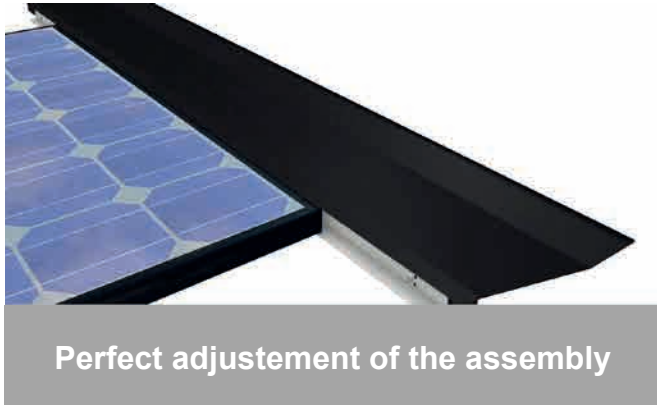

Make cuts on the attach angle at the position of the GSE panel corrugations

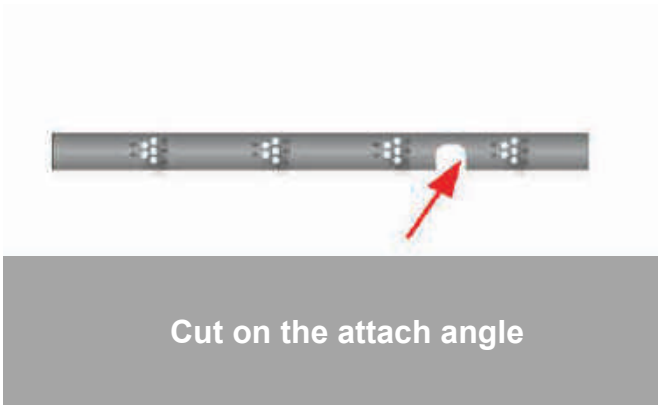

Place the top junction flashing, having applied beforehand two PU glue joints on the covered top flashing area. The connecting piece must overlap with the top flashing with at least 100 mm. The gap between the top flashings should not exceed 160 mm.

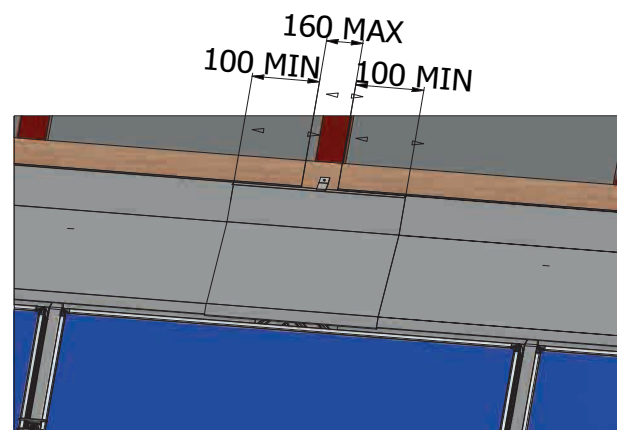
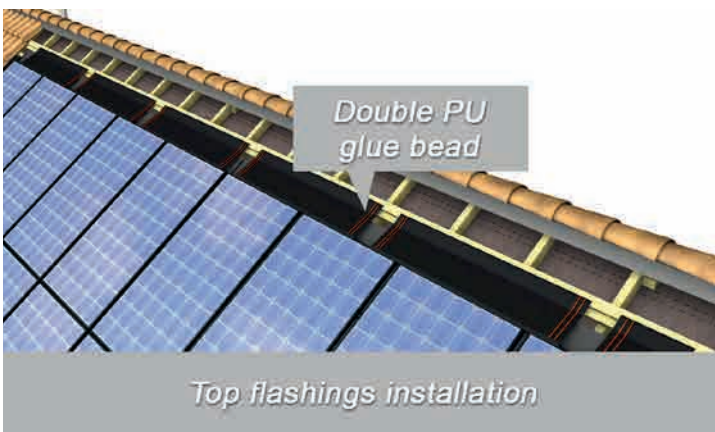

In the same way, place the corner flashings, having applied beforehand a PU glue joint on the overlapping zone of the top flashing. (Overlapping at least 100mm)

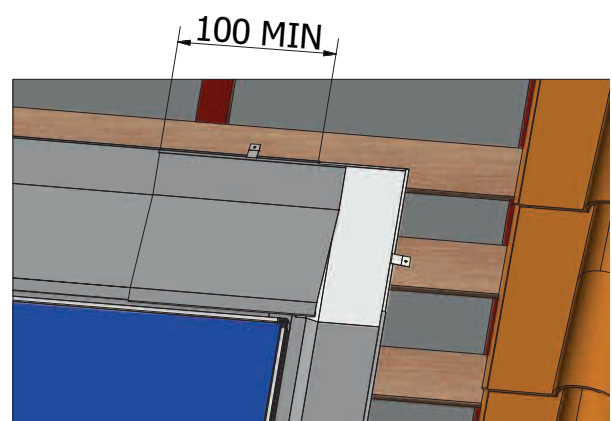
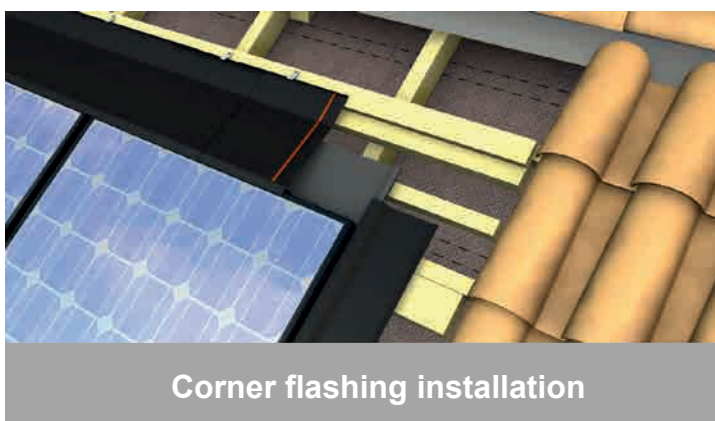



# 3. Installation

Fix all flashings to the battens using flashing hooks (at least 2 per piece).

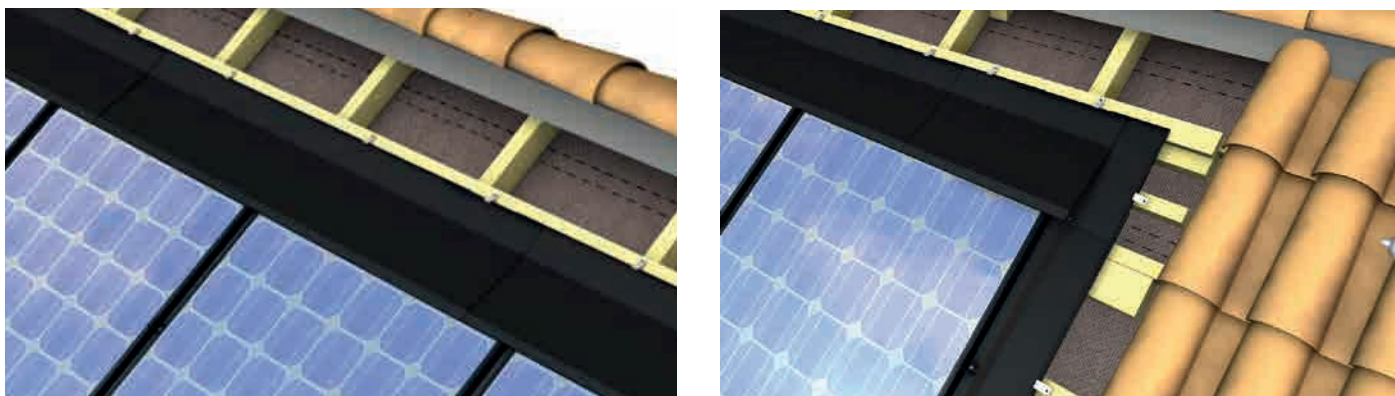

Place the precompressed seal on the flashings around the area on the lateral and upper parts.

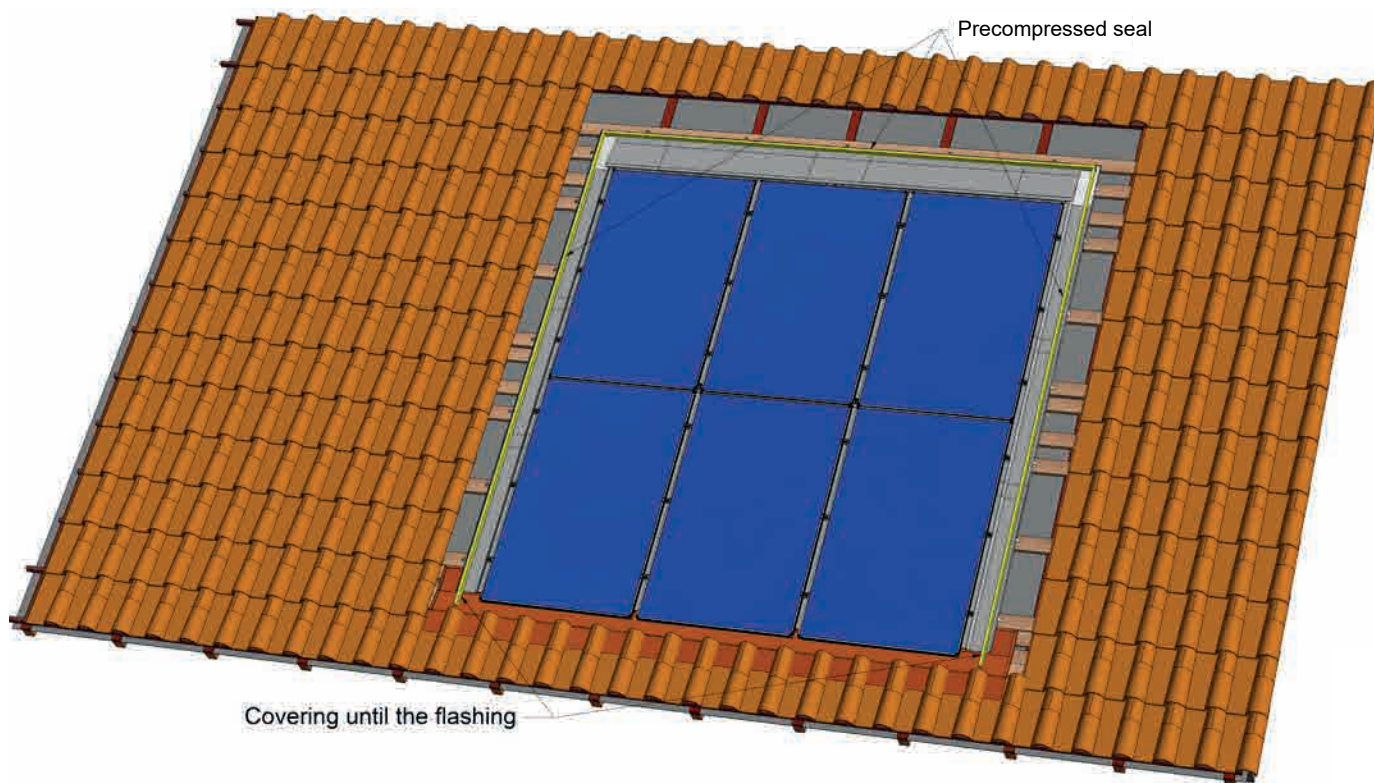

The seal must reach the bottom of the flexible flashing strip to prevent any potential infiltration of water or solid particles.

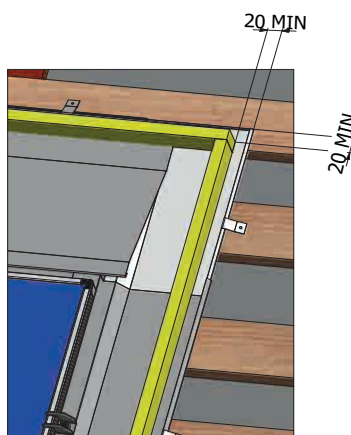

# 3. Installation

## OPTION: REPLACING TOP FLASHINGS WITH A FLEXIBLE STRIP

It is possible to install a flexible flashing strip or equivalent to make the connection with the upper roofing elements. Shape a 2-cm fold in the upper and lateral parts of the strip to prevent any water upwelling.

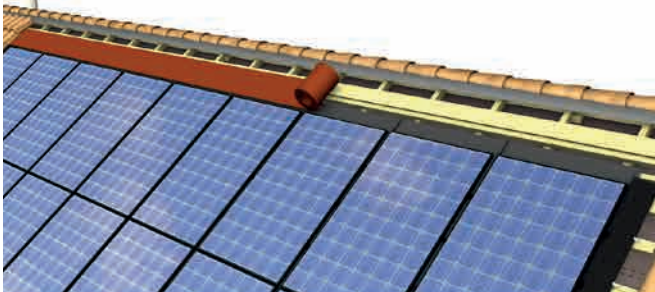

One flexible flashing strip can replace the top flashings



### 3.8 Specific case : PV array with inner/outer angles

In the case of non-rectangular PV array, inner and outer angles must be connected to the roofing using a flexible flashing strip compliant with the building/roofing regulation.

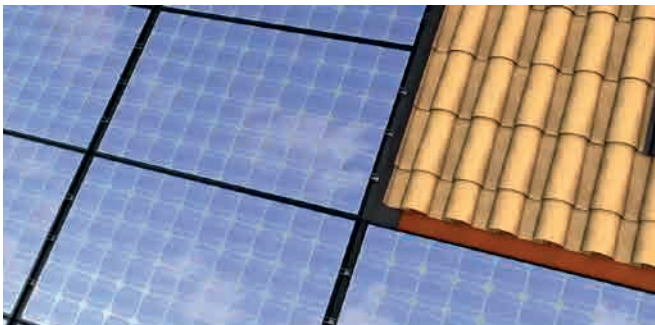

Singularity : inner angles



Singularity : outer angles

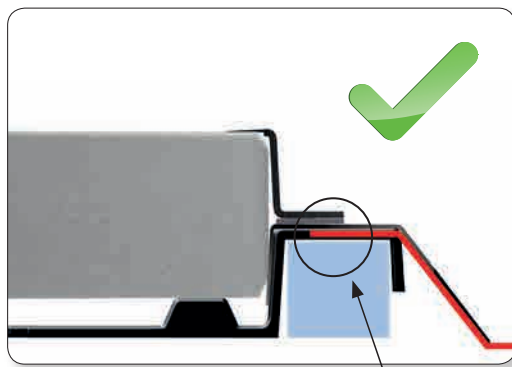

End the flashing strip on top of the corrugation

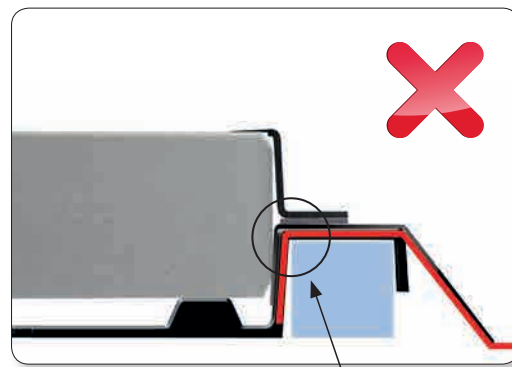

Risk of tearing

**ATTENTION:** IN BOTH CASES, THE FLEXIBLE STRIP CAUGHT BETWEEN THE FLASHING AND THE CORRUGATION OF THE GSE PANEL MUST BE POSITIONED ON TOP OF THE CORRUGATION TO PREVENT THE RISK OF TEARING.

# 3. Installation

## 3.8.1 Inner Angle (L-Shaped)

Place the flashing strip by covering the lower-row frames up to the corrugation of the adjacent frame, then cover the strip with the lateral flashing.

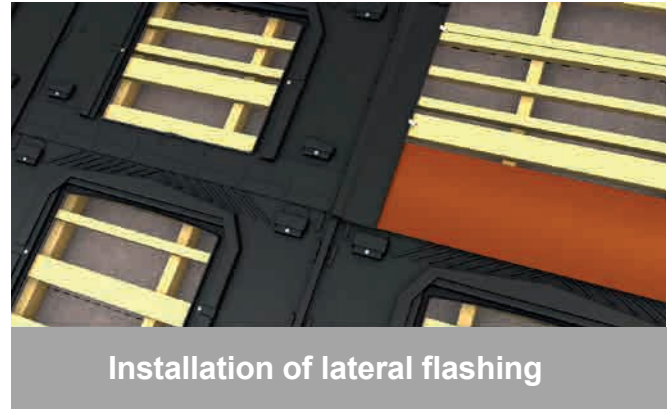
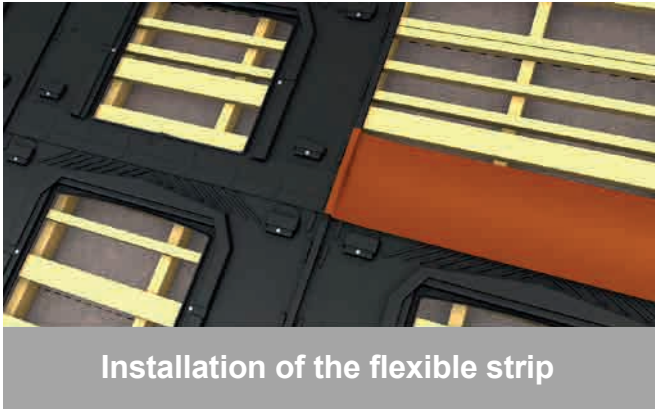

## 3.8.2 Outer Angle (T-Shaped)

Place the lateral flashing on the lower-row panel. Reposition the adjacent tiles to cover the lateral flashing, then place the flashing strip so that it overlaps with the last row of tiles, ensuring that there is a 2-cm fold in the upper section.

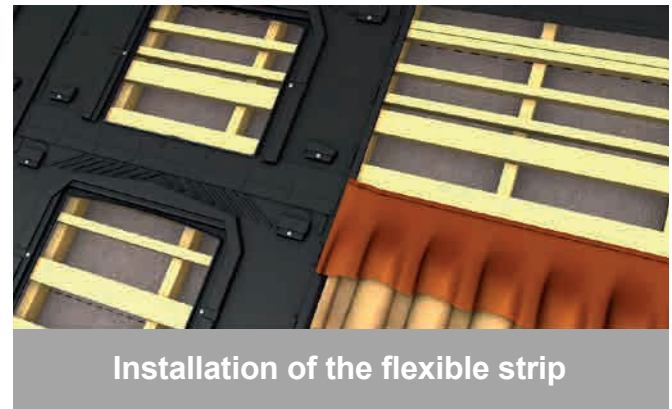
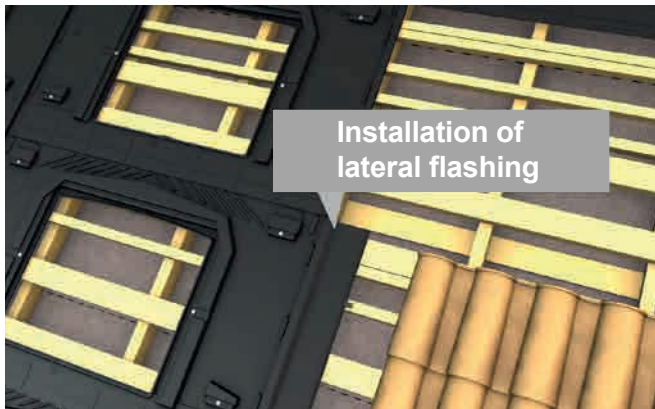

Then, position the GSE panel so that it's overlapping with the flashing strip.

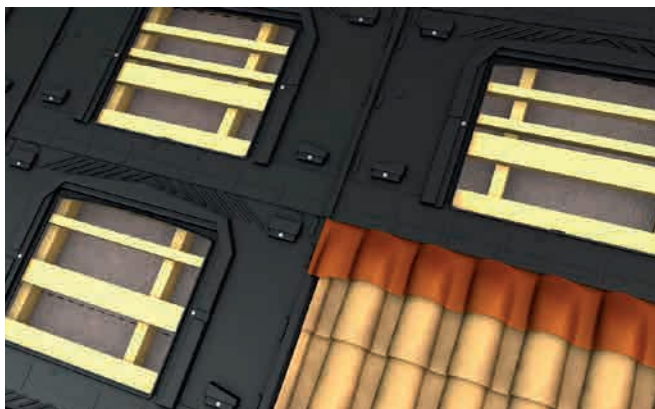

**ATTENTION:**  
FOR THE OVERLAP, FOLLOW ROOFING REGULATION AS WELL AS THE REQUIREMENTS IN SECTIONS 3.3 AND 3.7 OF THIS DOCUMENT.

# 3. Installation

## 3.9 Connection to the roof covering

Reposition the lateral and upper sections of the roofing elements to make a continuous and watertight connection with the roof.

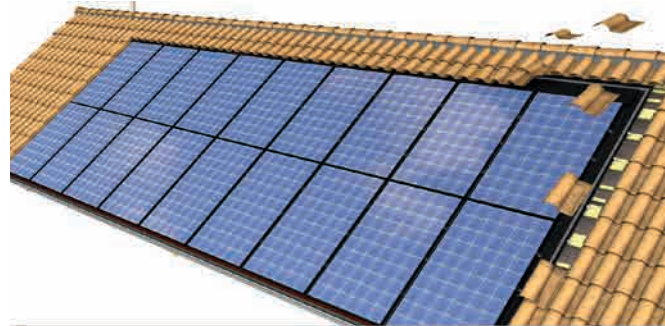

*Installation of the cutted tiles*

It may be necessary to cut the tiles to ensure a compliant overlap between the elements, according to roofing regulation. These elements must be attached mechanically, as described in the roofing regulation.



*Tiles cutting for left flashing*



*Tiles cutting for top flashing*

**TIP:**  
**YOU CAN USE DOUBLE TILES OR HALF TILES FOR THE LATERAL CONNECTION.**

The roof tiles must rest on the flashings with enough overlap to meet the requirements of the roofing regulation.

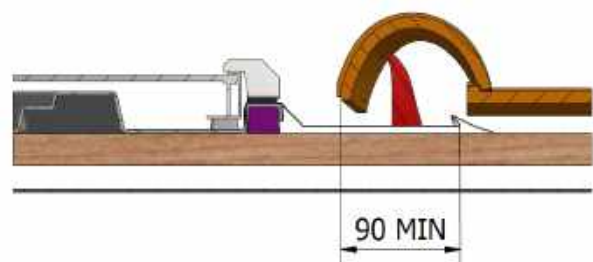
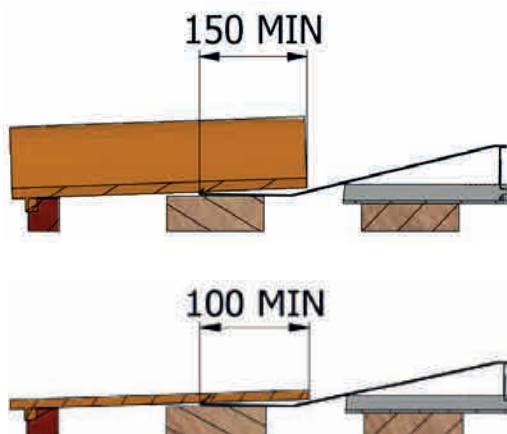

# 4. Maintenance and servicing

## 4.1 Verification



It is important to check once a year whether leaves and/or other elements have gone under the photovoltaic system or between the panels. You can use compressed air to remove elements that have gone under the photovoltaic system. Do not use solvents to clean the polypropylene supports.

We recommend a maintenance contract that includes one annual visit to check: production, electrical part, panels, panel supports, attachments, precompressed joints, sealing strip.

## 4.2 Module replacement

Disconnect the PV array from the AC box and proceed as follows:

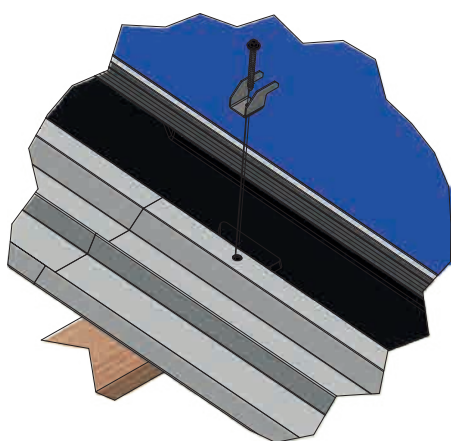

1• Unscrew the fixing clamp, remove the module and remove the edge wedges.

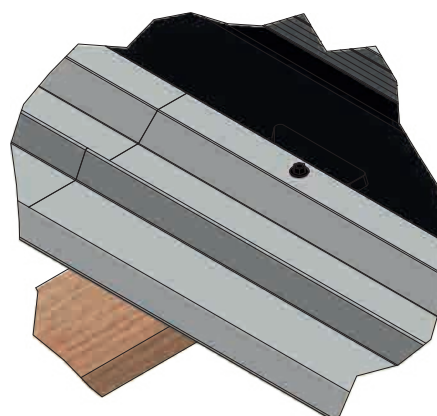

2• Screw one GSE screw at the location of old hole, having placed beforehand a new polypropylene edge wedges under the corrugation if it is located on an array edge.

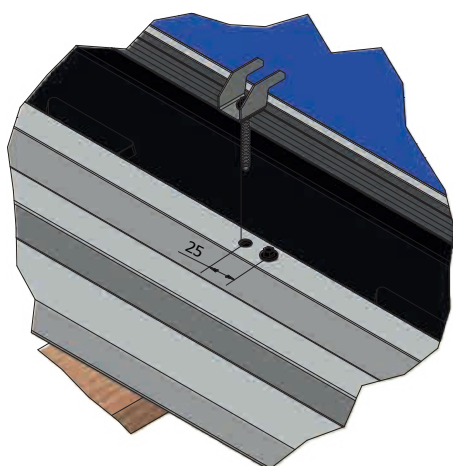

3• Make a new 10 mm hole, 25 mm above the old position.

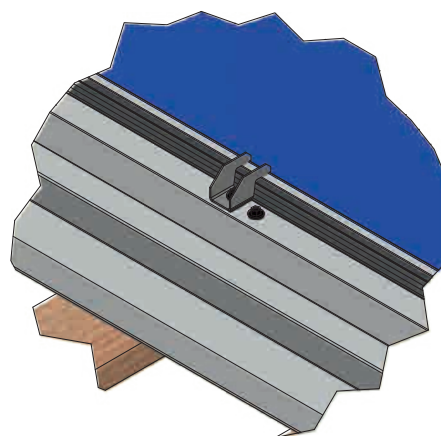

4• Place the module and attach the new assemblies (fixing clamp + EPDM foam + GSE screw).

# 5. Assistance and contact

## 5.1 Training session

GSE Integration team offers technical training on the product which can include practice on demonstration models upon your request, provided that there are enough participants.

For information, please contact your sales manager or your distributor.



## 5.2 Technical Assistance

**TECHNICAL SUPPORT IS AVAILABLE TO YOU FROM MONDAY TO FRIDAY FROM 9:30 A.M. TO 6:00 P.M. (GMT+01:00)**

**GSE**  
Intégration

155-159 rue du Docteur Bauer  
93400 SAINT OUEN (France)  
Tel.: +33(0)1.70.32.08.00

E-Mail: [contact@gseintegration.com](mailto:contact@gseintegration.com)

# 6. Certifications and warranties

## 6.1 Technical assessments

 **ETN n°010T170F** ✓

**ALPES**  
CONTRÔLES

 **Avis Technique n°21-16/57** ✓

**CC FAT**  
**AVIS**  
TECHNIQUE

 **MCS 012 – BBA 0156**

**BBA**  
CERTIFICATE BBA 0156

## 6.2 Fire Test

   **BRoof T1** ✓

 **BRoof T3** ✓

**warringtonfire**  
Proud to be part of 



 **BRoof T4** ✓



**GSE IN-ROOF SYSTEM** is a patented development project  
of GROUPE SOLUTION ÉNERGIE

**GSE**  
Intégration

---

Your distributor:

[www.gseintegration.com](http://www.gseintegration.com)