



Standalone Energy Storage Battery Quick Guidance

Version 1.0
2020-05-08



WARNING

- * Ensure to read the Guidance before installation in order to understand product information and safety precautions.
- * Operators should be well trained to fully understand grid-connected photovoltaic power system and national/regional standards.
- * Installers must use insulating tools and wear safety equipment.
- * Device damages caused noncompliance with storage, transportation, installation and usage requirements specified in Quick Guidance and Manual are not covered by Warranty.

1. Product Appearance

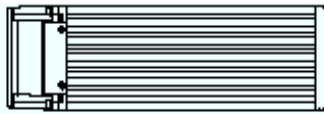
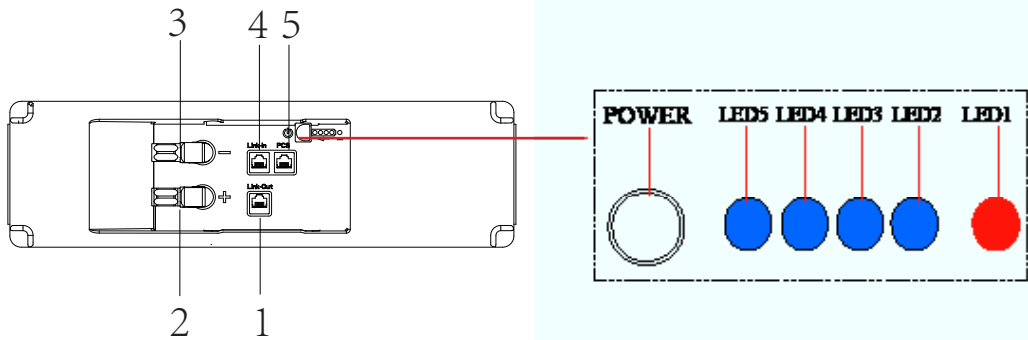

Side View

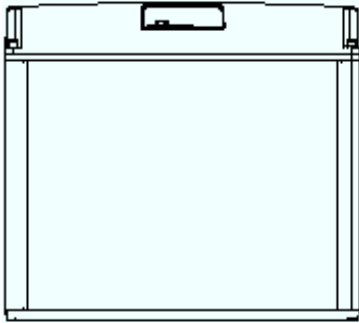

Top View

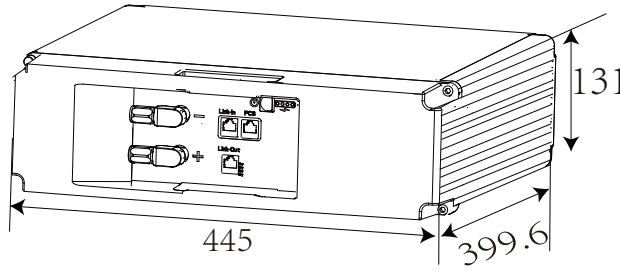

No.	Name	Description
1	Link-Out	In parallel communication, Network Cable B connects Link-Out port of one battery and Link-In port of the next battery or onfirming port of the last slave battery.
2	P+	Positive output port
3	P-	Negative output port
4	Link-In	In parallel communication, Network Cable B connects Link-In port of one battery and Link-Out port of the previous battery or confirming port of fist battery .
5	PCS	Network Cable A connects the port labelling "PCS" with PCS.

2 Electrical Connection



Before opening package, check for damages like holes, cracks or other traces on exterior packing case.
 Check and confirm the battery is powered off.
 Keep the dirt or dust at a minimal level.
 Do not install battery in a place where flood frequently occurs.
 Do not install battery in highly humid area such as bathroom.

2.1 Make Power Cable

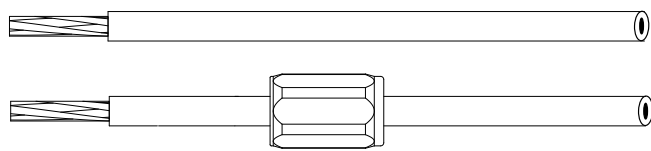
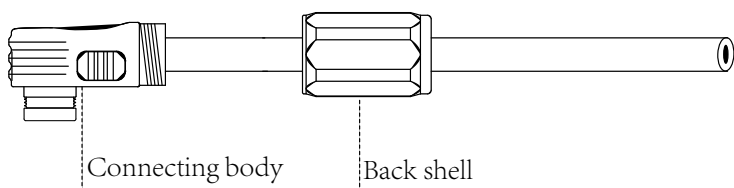

1. Strip cable sheaths for 18 ± 1 mm, with orange positive cable and black negative cable. Un-assemble the back shell along the cable as shown.

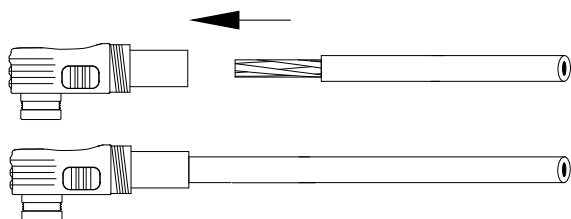

2. Insert the copper wires all into the lug of connecting body.

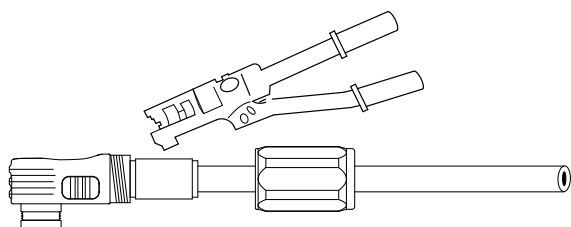

3. Press connecting part with a hydraulic clamp.

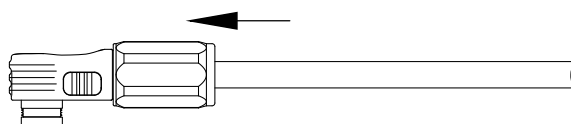

4. Tighten up connecting body and back shell.

2.2 Make Network Cable A

PCS

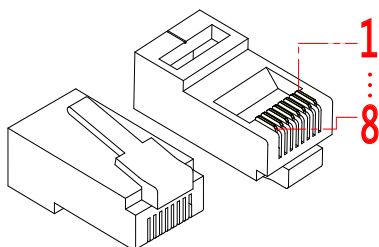
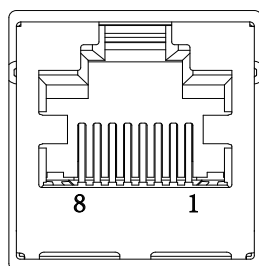

Pin no.	Name	Function Description
1	Dry2-	Dry port 2 negative
2	Dry2+	Dry port 2 positive
3	Dry1+	Dry port 1 positive
4	CAN0_H	PCS CAN H
5	CAN0_L	PCS CAN L
6	Dry1-	Dry port 1 negative
7	PCS_WAKE-	PCS wake up signal negative
8	PCS_WAKE+	PCS wake up signal positive



1. Strip cable sheaths for 15 ± 0.5 mm.

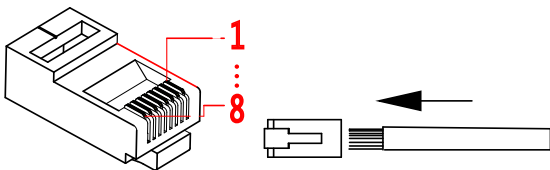

2. Network cable adopts standard 8-core cable. Insert eight wires into crystal plug of one end of network cable A. Ensure all wires stay well aligned. The other end is to be made by user based on the PCS communication definition.

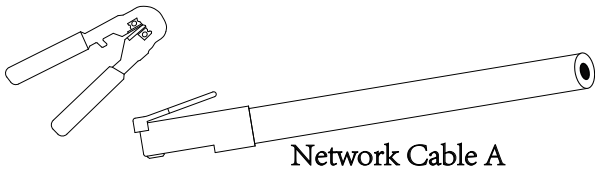

3. Crimp the crystal plug with a wire crimper.

Network Cable A

2.3 Make Network Cable B

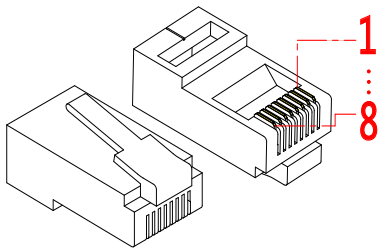

Link-Out

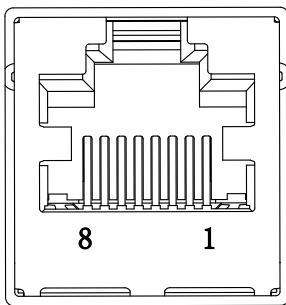

Pin no.	Name	Function Description
1	CAN2_H	Pack to Pack communication, CAN_H Line
2	CAN2_L	Pack to Pack communication, CAN_L Line
3	Ecode_OUT+	program address function ,output
4	ISO_GND	ISO_GND
5	Slave IN	Slave pack select
6	Dry1-	Dry Point contact
7	Dry1+	Dry Point contact
8	Syn_Wake In/Out	synchronization power on

Link-In

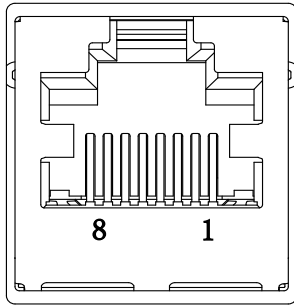

Pin no.	Name	Function Description
1	CAN2_H	Pack to Pack communication, CAN_H Line
2	CAN2_L	Pack to Pack communication, CAN_L Line
3	Ecode_IN+	program address function ,output
4	ISO_GND	ISO_GND
5	Master IN	Master pack select
6	Dry1-	Dry Point contact
7	Dry1+	Dry Point contact
8	Syn_Wake In/Out	synchronization power on

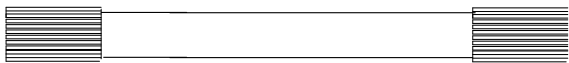

1. Strip cable sheaths for 15 ± 0.5 mm.

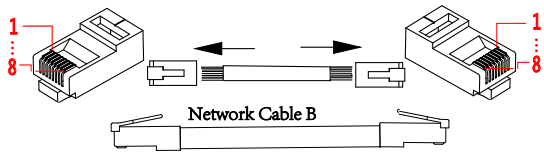

2. Network cable adopts standard 8-core cable. Insert eight wires into crystal plugs. Ensure the color of wires in crystal plugs stay consistent and have pin-to-pin plugs in two ends of network cable B.

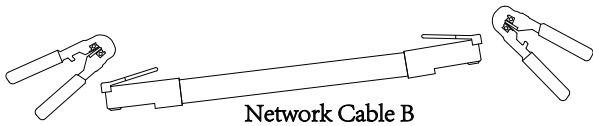

3. Crimp the crystal plug with a wire crimper.

2.4 Electrical Connection Process

2.4.1 Single Battery Connection

Step 1: Power off the battery.

Step 2: Connect network cable.

Insert M-plug into port 4 of the battery.

Plug one end of Network Cable A into port 5 and the other end into PCS.

Insert the S-plug into port 5 of the last battery.

Step 3: Connect power cable

Plug positive power cable into port 3 and junction box, and plug the negative power cable into port 2 and junction box.

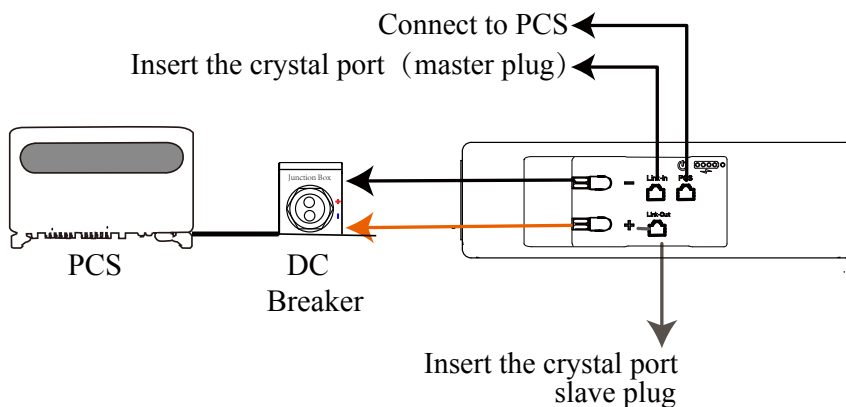
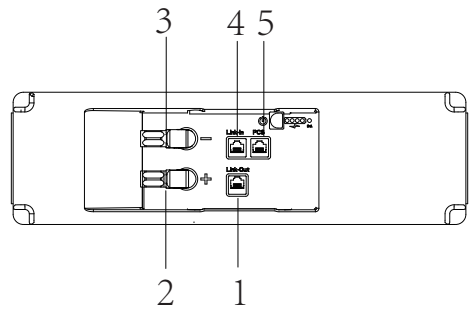

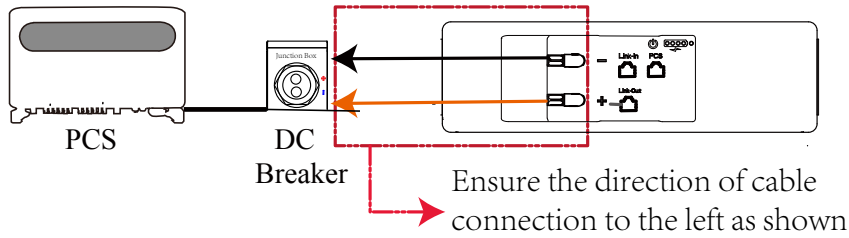

2.4.2 Electrical Connection under Parallel Mode

Step 1: Power off the battery.

Step 2: Connect network cable.

Insert M-plug into port 4 of the first battery.

Plug one end of Network Cable A into port 5 of the first battery and the other end into PCS.

Plug one end of Network Cable B into port 1 of the first battery, and the other end into port 4 of the second battery. The process goes on until the last battery.

Insert the S-plug into port 5 of the last battery.

Step 3: Connect power cable

Plug positive power cable into port 3 of battery and junction box, and plug the negative power cable into port 2 of battery and junction box.

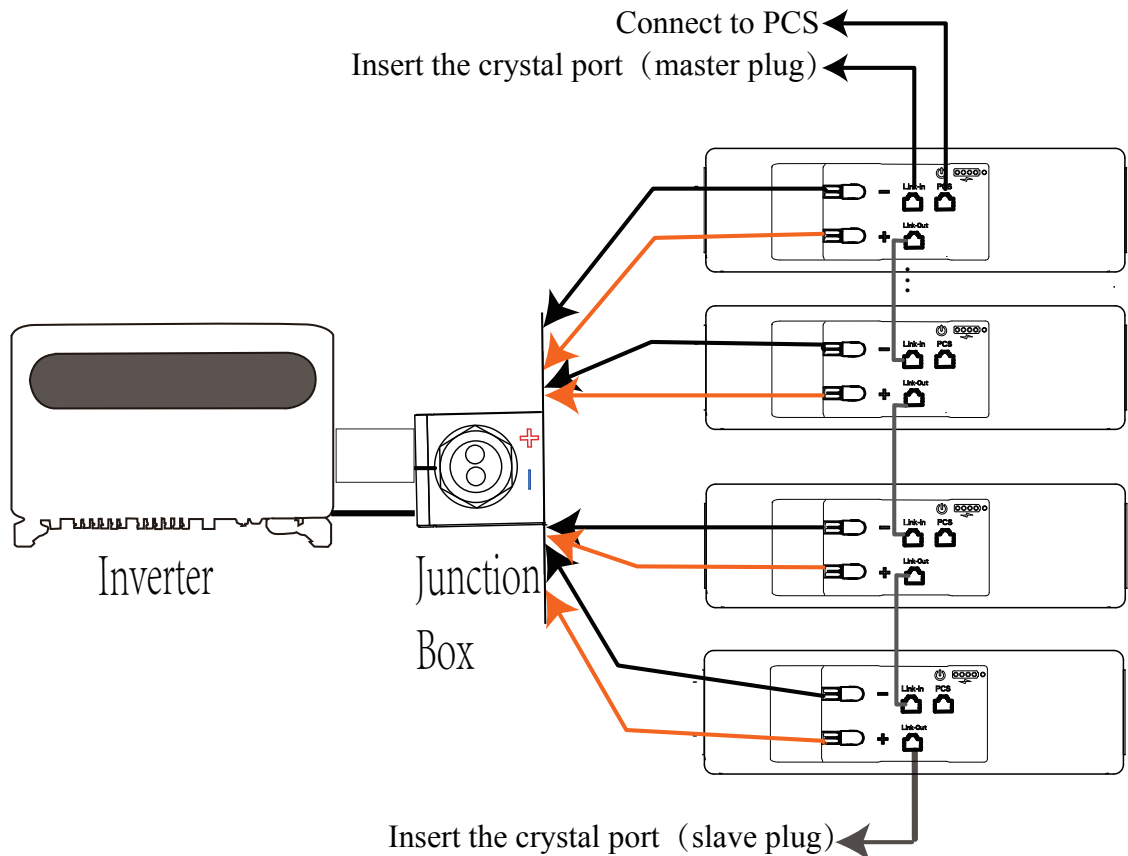

 **WARNING**

- * Each battery shall be equipped with a DC breaker and the recommended parameters are: Rated Voltage $\geq 120\text{VDC}$ Rated Current $\geq 60\text{A}$ Cut-off current: 1800A
- * If voltage difference is measured more than 1V, the difference shall be adjusted to be less than 1V either by charging the battery with lower voltage or discharging the battery with higher voltage before conducting the parallel-connected installation.
- * Ensure install battery into rack in compliance with the instructions and do not place batter upside down. If battery has to be used outside room, ensure the battery is contained inside a rack with at least IP55 protection. If the battery is used inside romm, ensure the relative humidity range between 5%-85%.
- * The distance between ground and lower part of battery shall not exceed 1m. A deviation of $-5^\circ \leq \theta \leq 5^\circ$ is allowed for installation. A deviation of $-5^\circ \leq \theta \leq 5^\circ$ is allowed for installation.

4 Power on/off Battery

 **CAUTION**

- * Technical knowledge is involved in the electrification process, and electricians must go through technical training and obtain certificates in compliance with local law and regulations.
- * If other people are not allowed to operate, the prohibition sign should be hung on the distribution equipment: "No closing, someone operating."
- * Please stand on dry insulating objects and do not wear metal objects such as watches, necklaces and rings during operation. Insulating tools should be used.
- * Do not contact with two charged positions with potential difference.
- * Make sure that the PCS is turned off before checking battery.

4.1 Power on battery

Press POWER button for three seconds. LED lights flicker and the battery is powered on.

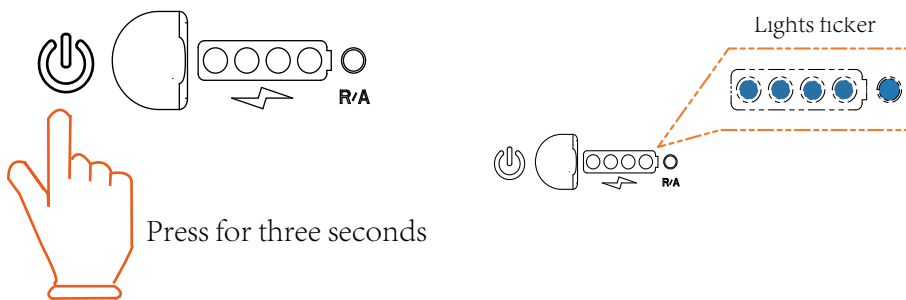

4.2 Power off battery

Press the POWER button for three seconds. LED lights flicker before turning off. The battery is then powered off.