

EV CHARGER

INSTALLATION MANUAL

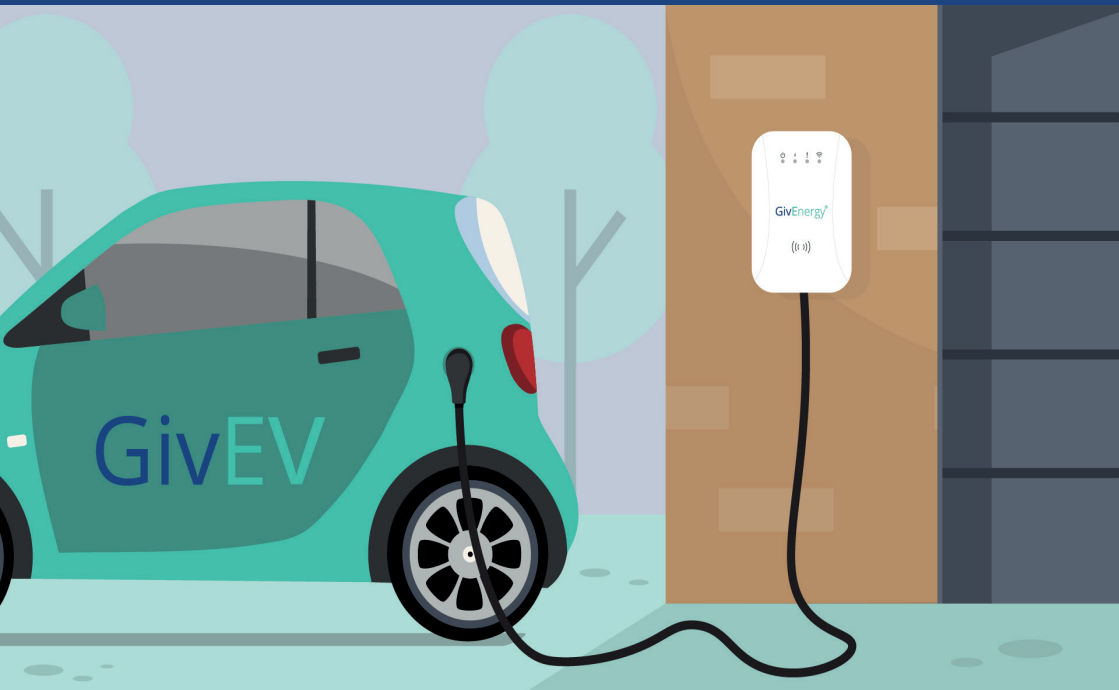

GivEnergy®

Contents

1 Installation

1.1 Package Contents and Inspection	1
1.1.1 Packaging List	1
1.1.2 Packaging	2
1.2 Preparing the EV Charger	2
1.3 Power Supply	4
1.3.1 Connecting the Communications Cable	5
1.4 Installation	6
1.5 Charging Port	7

2 Operation

2.1 Powering on the EV Charger	8
2.2 EV Charger Interface	8
2.2.1 Overview	8
2.2.2 LED Indicators	9
2.2.3 RFID Card Reader	9
2.2.4 RFID Tag	10
2.3 Connecting your EV Charger to WiFi	10
2.4 Charging Connectors	12
2.5 Charging	12
2.6 Stopping the EV Charger	13
2.7 Fault Stop	13

3 Fault Handling

14

1 Installation

1.1 Package Contents and Inspection

1.1.1 Packaging List

Package	Quantity
EV Charger	1 pc
Charge plug dock	1 pc
RFID card	2 pcs
Wall-mounting accessories (including A+B+C+D as Fig. 1.1 shown)	1 set
User manual	1 pc

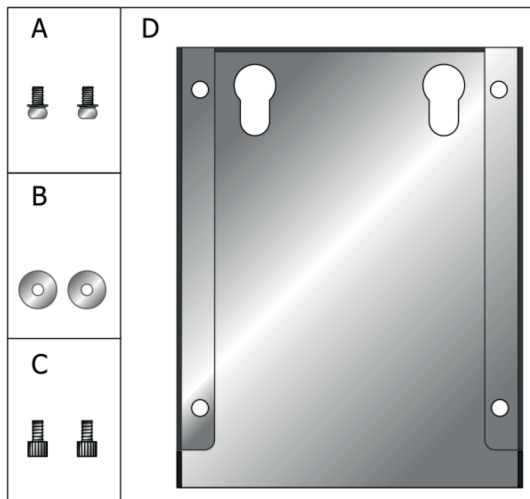

Fig. 1.1 Wall-mounting accessories

1.1.2 Packaging

When unpacking, please check the following:

- There are no missing accessories from the packaging list
- If there was any damage during transit
- The model and specification of the charger's nameplate match the order specifications



If any damaged or missing parts are found, **do not start the charger**. Contact GivEnergy on 01377 252 874 or email support@givenergy.co.uk immediately. Please retain the packaging for future purpose.



The paper packaging is recyclable.

1.2 Preparing the EV Charger

When transporting or moving the charging station, the following must be considered to ensure product safety:



The EV Charger is an electrical device, it should be handled with care, avoiding any forceful impacts or vibrations. Do not move the charging station by dragging the vehicle connector or charging cable.

- In order to ensure the long-term stable operation of the product, it is recommended to avoid installing charging stations in extreme weather where possible, especially in low or high ambient temperature as this may affect the installation due to thermal expansion and cold contraction.
- The electrical power supply cable must be prepared.
- Space requirement: when the charging station is fixed on the wall, the minimum space requirements are shown in Fig 1.2.

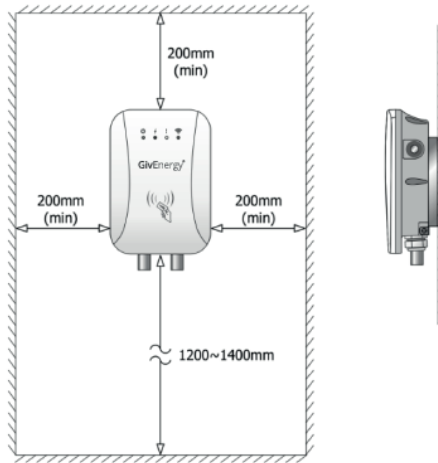



Fig. 1.2 Minimum space requirements for wall mounting

- It is suggested that the charging station should be installed in a place with good ventilation, no direct sunlight and shelter from wind and rain.
- In order to ensure good ventilation conditions, you should mount the charging station vertically and leave enough space.

Prepare the following tools before installing the AC EV charging station:

Sr No.	Tools Name	Schematic Picture	Main Users
1	Multimeter		Check the electrical connection and measure the voltage
2	Electric Impact Drill		Drill fixing holes in the wall
3	Wrench		Fastening bolts

Sr No.	Tools Name	Schematic Picture	Main Users
4	Diagonal plier		Cut the cable
5	Wire stripper		Strip cables
6	Crimping tool		Press cable terminal
7	Crosshead screwdriver		Fasten screws

1.3 Power Supply

The EV Charger is available for installation in any TN power supply system.

a) TN-S power supply system wiring mode

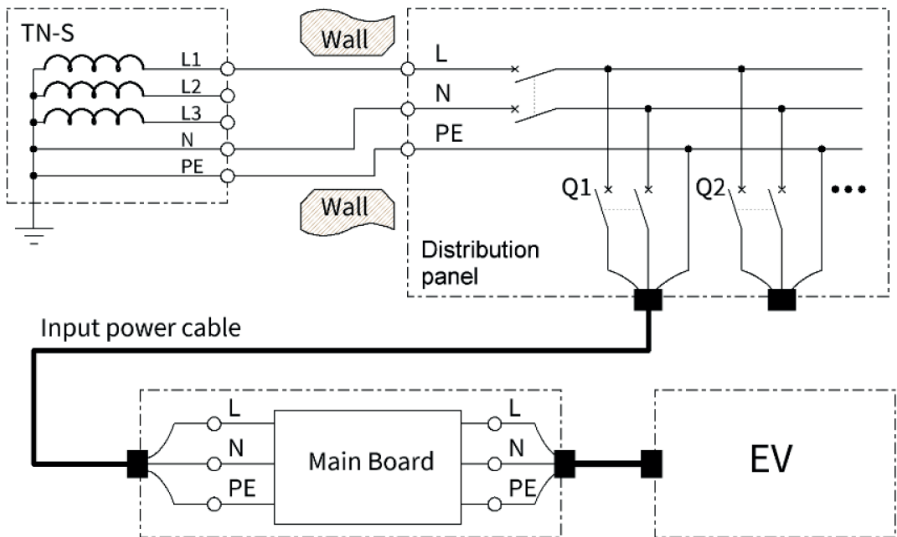

Fig. 1.3 TN-S system installation

b) TN-C power supply system wiring mode

In TN-C, for local earth rod where there is no connection to install, a series of circuits are set inside the EV Charger to protect safety. Even if leakage fault occurs when PEN is disconnected or three-phase voltage is unbalanced, the EV Charger can quickly interrupt charging and protect the personal safety of users.

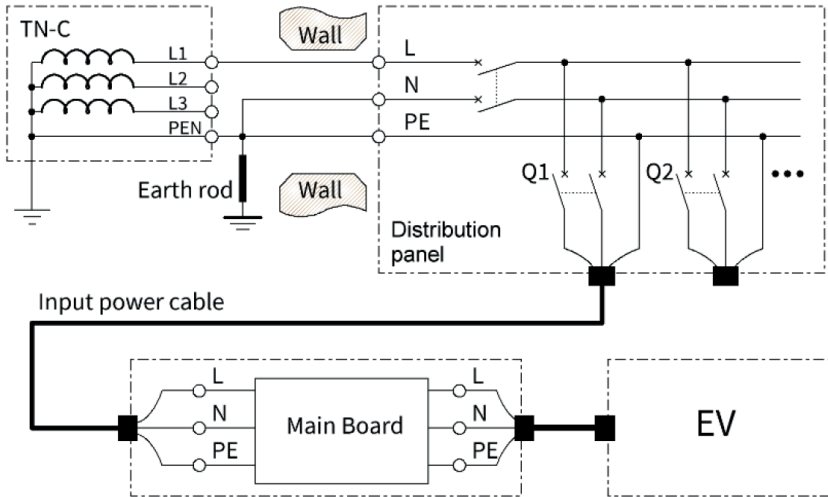
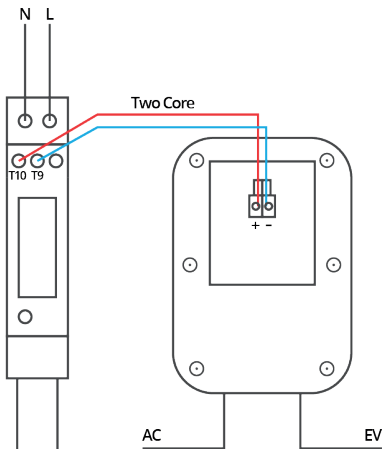

Fig. 1.4 TN-S system with earth rod system installation

c) TN-C power supply system wiring mode

The connection method is the same as that of the TN-S power supply system.

1.3.1 Connecting the Communications Cable



A two core shielded communication cable must be wired between the charger and the EM115 meter, in order for the charger to charge the vehicle from excess solar.

Additionally, the charger can be wired directly to the GivEnergy inverter in to the meter communication port so that the charger can be controlled by the inverter (coming soon).

1.4 Installation

Install the charging station on the wall following the steps below:

Step 1: Installing the Charging Station Mount

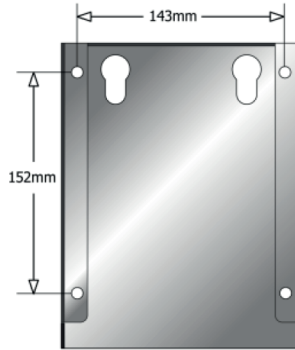

Fig. 1.5 The fixing holes of accessories-D

Drill 4 holes with a diameter of 10mm and depth of at least 50mm on the wall with spacing of 143mm x 152mm, secure the accessories-D to the wall with expansion screws.

Step 2: Wiring the Charging Station

As shown in Fig. 1.6, unscrew all 6 screws [A] to open the front cover of the charging station, there is no need to unscrew the inner 4 screws.

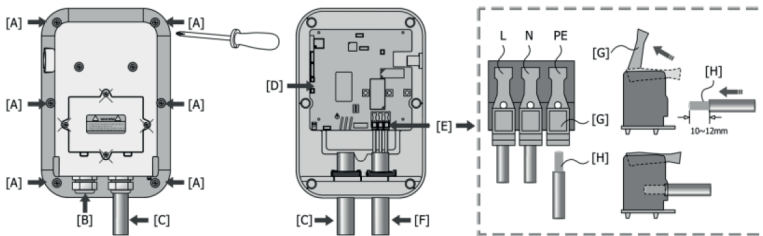

Fig. 1.6 Anatomy of the charging station

- | | |
|------------------------------|--------------------------|
| [A] Screw | [B] Gland of input cable |
| [C] Charging cable | [D] Main board |
| [E] Terminals of input power | [F] Input power cable |
| [G] Lever of terminal | [H] Wire conductor |

- Loosen the gland [B] and pass the prepared power cable through it
- Remove 10-12mm of insulation from the wire conductor [H]
- Pull up the level [G] to open the terminal, plug the wire conductors into each terminal, press the lever down [G] to make sure every wire conductor is securely connected to the terminal
- Screw in all 6 screws [A] to secure the front cover of the charging station
- Tighten the gland of the input cable

Step 3: Mount the Charging Station

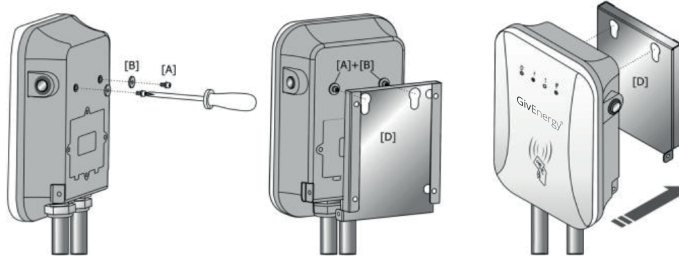

Fig. 1.7 Mounting the charging station

As shown in Fig. 1.7, secure mounting accessories [A]+[B] to the charging station; attach the charging station to the mount [D].

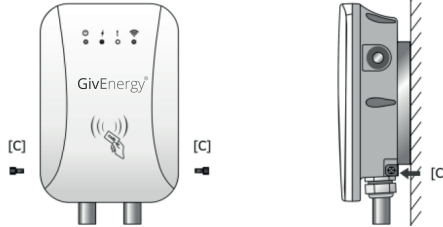

Fig. 1.8 Mounted Charging Station

Tighten the screws [C] on the left and right of the charging station as shown in Fig. 1.8.

1.5 Charging Port



When the charging station is in standby state, please plug the vehicle connector in to the empty connector socket in order to protect the vehicle connector. Please use expansion screws to fix this empty socket at a suitable position beside the charging station.

Fig. 1.9 Charging Port

2 Operation

2.1 Powering On the EV Charger

After the charging station has been installed, switch on the power supply. The indicator light [A] lights up and the charging station switches to standby state.

2.2 EV Charger Interface

2.2.1 Overview

The EV Charger interface is configured with multiple LED indicators as shown in Fig. 2.1.

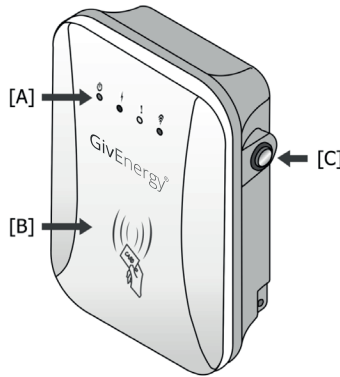

Fig. 2.1 Interface of EV Charger





[A] 4 LED lights: Indicates 4 statuses: Standby; Charging; Fault; and Network

[B] RFID Card Reader: Swipe the RFID card to begin charging

[C] RFID Pairing for additional RFID tags

2.2.2 LED Indicators

The LED indicators on the panel are used to indicate the status of the charging station. The various combinations of indicators are described below:

No.	Icon	Indicator Colour	Indicator Status	Connotation
1		Green	ON	Standby status
			Blinking	Ground fault status
2		Red	ON	Connected to an EV
			BLN control	Charging status
3		Yellow	Blinking	Fault status Twinkle frequency indicates the fault code
4		Blue	OFF	Unconnected network
			ON	Connected to the network
			Slow blink	Exchange data with CMS via network
			Fast blink	Configure WiFi network status

2.2.3 RFID Card Reader

The EV Charger is equipped with an RFID card reader as standard, enabling the charger to be started and stopped when required (Fig. 2.2).

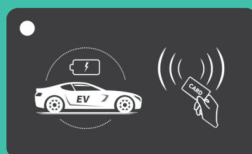

Fig. 2.2 RFID card

2.2.4 RFID Tag

To pair a new RFID tag:

- Hold the button until the WiFi light has a fast blinking LED
- Hold the new RFID tag up to the RFID reader until pairing is successful

2.3 Connecting your EV Charger to WiFi

Step 1: Connect via the GivEnergy App

Follow the step by step guide in the GivEnergy App. If you don't have the GivEnergy App, go to Step 2.

Step 2: Connect to WiFi hotspot

Within two minutes after powering on, the charging station provides a WiFi hotspot. Connect to the WiFi hotspot (e.g. "EVSE-12345678") in the WiFi list of your device. The password can be found on the sticker on the side of the charging station.



Fig. 2.3 Password displayed on sticker on side of charging station

Step 3: Login to Settings

Enter 192.168.4.1 in the address bar of your Internet browser on your device. You can access the configuration page as shown in Fig 2.4. The password is 12345678.

Note: Microsoft Internet Explorer cannot access this website.

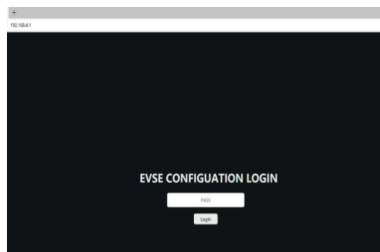

Fig. 2.4 Login of EVSE CONFIGURATION

Step 4: Configure your EV Charging Station

You will need to contact GivEnergy support on 01377 252 874 or email support@givenergy.co.uk for a temporary login password. The password must be changed after first login.

The screenshot displays the 'EVSE CONFIGURATION' interface, divided into two main sections: 'User Options' and 'Advanced Options'. Each option is presented as a label followed by a text input field and a radio button. The 'User Options' section includes fields for 'WiFi name' (MY-WIFI), 'WiFi password' (Customer WiFi password), and 'Button controlled' (No). The 'Advanced Options' section includes fields for 'Serial Number' (EV Charger Serial Number), 'OCPP server' (wss://ev.comms.givenergy.cloud:7655), 'OCPP version' (OCPP1.6-J), 'OCPP Authpass' (0), 'Access point name' (EVSE-12345678), 'Alternative server' (No), 'Charging current' (32), and 'Login password' (*****). Below the input fields are two buttons: 'SAVE' and 'RESTART'. The interface also includes several explanatory callouts: 'Enter WiFi name', 'Enter WiFi password', 'No - Card and App Controlled', 'Serial number is displayed on screen', 'URL of OCPP server', 'Version of OCPP communication', 'OCPP Auth password', 'Enter WiFi hotspot name', 'Exchange data with supplier backstage Yes - Permit; No - Do not permit', 'Set the maximum charging current', and 'Choose a new password'. A final callout 'Save settings' points to the 'SAVE' button.

EVSE CONFIGURATION

User Options

WiFi name: MY-WIFI (Enter WiFi name)

WiFi password: Customer WiFi password (Enter WiFi password)

Button controlled: No (No - Card and App Controlled)

Advanced Options

Only change these if you are qualified to install this product.

Serial Number: EV Charger Serial Number (Serial number is displayed on screen)

OCPP server: wss://ev.comms.givenergy.cloud:7655 (URL of OCPP server)

OCPP version: OCPP1.6-J (Version of OCPP communication)

OCPP Authpass: 0 (OCPP Auth password)

Access point name: EVSE-12345678 (Enter WiFi hotspot name)

Alternative server: No (Exchange data with supplier backstage Yes - Permit; No - Do not permit)

Charging current: 32 (Set the maximum charging current)

Login password: ***** (Choose a new password)

SAVE (Save settings)

RESTART (Restart button for settings to take effect)

Fig. 2.5 Set parameters to configure the EV charging station

After entering the above credentials, click the "SAVE" button to apply the settings. Click the "RESTART" button to restart the EV Charger for the updated settings to take effect. Enter your WiFi name and password as instructed in Fig. 2.5. Once the changes take effect, the EV Charger is now connected to your WiFi.

2.4 Charging Connectors

The EV Charger is supplied with a Case C connection (EN IEC 61851-1:2019).



Case C:

Connection of an EV Charger to a supply network, utilising a cable and vehicle connector permanently attached to the EV charging station.

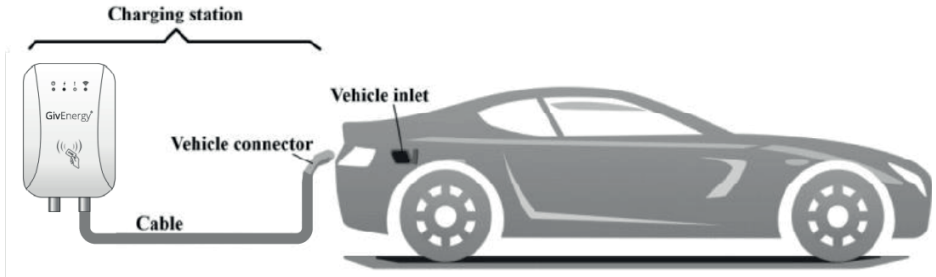

Fig.2.6 Schematic diagram of CASE C connection

2.5 Charging

- Before plugging in your vehicle connector, ensure that the vehicle is turned off and the handbrake is on
- Remove the vehicle connector from the charging station
- As shown in Fig 2.7. plug the vehicle connector into the vehicle inlet
- You can control the charging process via the GivEnergy App (QR code can be found on page 13) by swiping the RFID card across the card reader on the front of the charging station



Fig. 2.7 **Left:** Vehicle Charging Port. **Right:** Vehicle Connector.



GivEnergy App

Monitor your energy with the GivEnergy App. Control your solar system, EV Charger and Smart Plugs (coming soon) on the go.

Android

Scan the QR code to be taken to the Google Play Store. From there, click 'Download' to begin installation of the GivEnergy App.



iOS

Scan the QR code to be taken to the App Store. From there, click 'Download' to begin installation of the GivEnergy App.



2.6 Stopping the EV Charger

The EV Charger will automatically stop charging when the electric vehicle is fully charged. Alternatively, you can stop the EV Charger from charging in the following ways:

- Swipe your RFID card across the card reader on the front of the charging station
- Press the 'stop' button on the EV Dashboard in the GivEnergy App

Please return the vehicle connector to the vehicle port next to the charging station once charging has stopped.

2.7 Fault Stop

- Forced fault stop: A fault stop initiated by the onboard vehicle charger
- Automatic fault stop: A fault stop initiated by the charging station

3 Fault Handling

The charging station is automatically protected in the event of a fault. The fault information and handling methods are as follows.

LED indicator information	Fault code	Handling method
No LED lights	None	<ul style="list-style-type: none">• Check whether the power supply and distribution are normal• Check whether the branch breaker is tripped, and close the breaker after troubleshooting• Check all connections are secure
LED flashes	Fault code 11: CP Voltage Anomaly	<ul style="list-style-type: none">• Check the connection of vehicle connector and EV socket• Disconnect and reconnect the vehicle connector
1 x slow 3 x fast	Fault code 13: Undervoltage Input	<ul style="list-style-type: none">• Check the input cable is securely connected• Check for any abnormalities in the input voltage
1 x slow 4 x fast	Fault code 14: Overvoltage Input	<ul style="list-style-type: none">• Check the input cable is securely connected• Check for any abnormalities in the input voltage
1 x slow 5 x fast	Fault code 15: Over-temperature Protection	<ul style="list-style-type: none">• Check that the charging station is covered or installed in a high temperature environment
1 x slow 6 x fast	Fault code 16: Metering Fault	<ul style="list-style-type: none">• Power off and restart the charging station

LED flashes continued...

1 x slow 7 x fast	Fault code 17: Leakage Protection	<ul style="list-style-type: none">• Check if the vehicle connector and cables are damaged or wet• Ensure that the vehicle port is covered when the vehicle connector is not present
1 x slow 8 x fast	Fault code 18: Leakage Protection	<ul style="list-style-type: none">• Check if the vehicle connector and cables are damaged or wet
1 x slow 9 x fast	Fault code 19: Output	<ul style="list-style-type: none">• Check the vehicle connector is securely connected• Disconnect and reconnect the vehicle connector
2 x slow 1 x fast	Fault code 21: EV Response Timeout	<ul style="list-style-type: none">• The vehicle is fully charged• Check that the vehicle connector is securely connected• Disconnect and reconnect the vehicle connector
2 x slow 2 x fast	Fault code 22: Vehicle is not supported	<ul style="list-style-type: none">• The vehicle is not compatible with the EV Charger and does not meet the IEC standard
2 x slow 3 x fast	Fault code 23: Vehicle is not supported	<ul style="list-style-type: none">• This device is damaged and needs to be returned to GivEnergy
2 x slow 4 x fast	Fault code 24: RCD Fault	<ul style="list-style-type: none">• The RCD is damaged and needs to be returned to GivEnergy
2 x slow 5 x fast	Fault code 25: Ground Fault	<ul style="list-style-type: none">• Charging station is not grounded; input power cable needs to be checked

GivEnergy[®]

www.givenergy.co.uk