

# Enphase IQ8MC, IQ8AC, and IQ8HC Microinverters

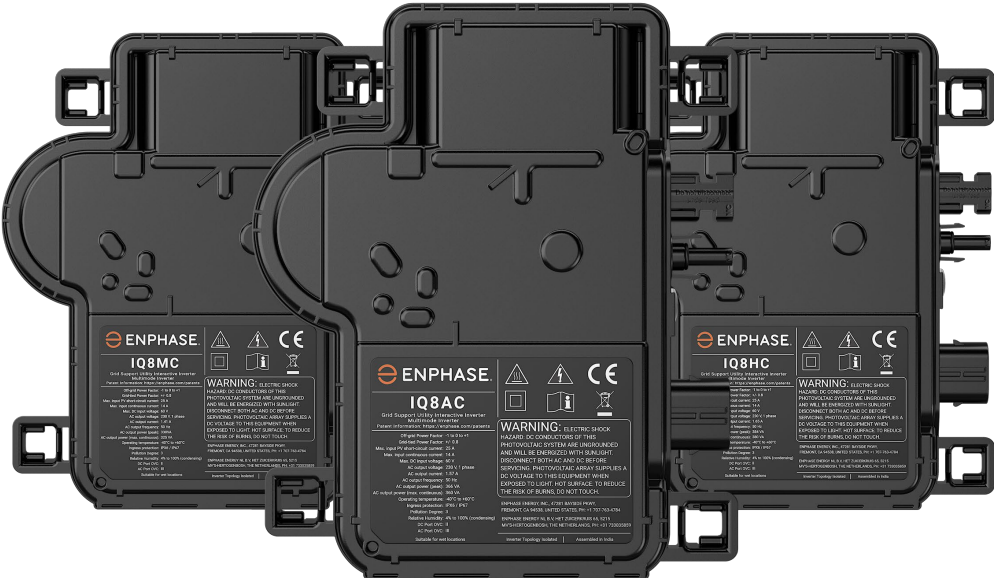

## Corporate Headquarters Contact Information

### Enphase Energy Inc.

47281 Bayside Pkwy, Fremont, Ca 94538, United States, Ph: +1 (707)-763-4784

<https://enphase.com/contact/support>



### Other information

Product information is subject to change without notice. All trademarks are recognized as the property of their respective owners.

User documentation is updated frequently; check the Enphase website for the latest information.

<https://enphase.com/en-gb/installers/resources/documentation>

To ensure optimal reliability and to meet warranty requirements, the Enphase microinverter must be installed according to the instructions in this manual. For warranty text, refer to

[enphase.com/installers/resources/warranty](https://enphase.com/installers/resources/warranty)

For Enphase patent information, refer to <https://enphase.com/patents>

Any third-party manufacturer or importer of product(s) used to install or commission Enphase product(s) shall comply with the applicable EU Directive(s) and requirements in the EEA (European Economic Area). It is the responsibility of the installer to confirm that all such products are labeled correctly and have the required compliant supporting documentation.

#### Manufacturer:

Enphase Energy Inc.  
47281 Bayside Pkwy,  
Fremont, CA, 94538  
United States of America  
PH: +1 (707)-763-4784

#### Importer:

Enphase Energy NL B.V.,  
Het Zuiderkruis 65,  
5215MV, 's-Hertogenbosch,  
The Netherlands,  
PH: +31 73 3035859

### Compliance with EU Directives

This product complies with the following EU Directives and can be used in the European Union without any restrictions.

- Electro Magnetic Compatibility (EMC) directive 2014/30/EU
- Low voltage directive (LVD) 2014/35/EU
- Restriction of Hazardous Substances (RoHS) 2011/65/EU

The full text of the EU declaration of conformity (DoC) is available at the following internet address

<https://enphase.com/en-gb/installers/resources/documentation>

© 2023 Enphase Energy. All rights reserved. Enphase, the e and CC logos, IQ, and certain other marks listed at <https://enphase.com/trademark-usage-guidelines> are trademarks of Enphase Energy, Inc. in the US and other countries. Data subject to change.

### Audience

This manual is intended for use by professional installation and maintenance personnel.

## Contents

<b>Important safety information</b> .....	<b>4</b>
Read this first .....	4
Product labels.....	4
Safety and advisory symbols.....	4
IQ8 Series Microinverters safety instruction .....	5
<b>1. The Enphase Energy System</b> .....	<b>8</b>
<b>2. Planning for microinverter installation</b> .....	<b>10</b>
<b>3. Parts and tools required</b> .....	<b>12</b>
<b>4. Enphase microinverters installation</b> .....	<b>13</b>
Step 1: Position the IQ Cable.....	14
Step 2: Position the junction box .....	14
Step 3: Mount the microinverters .....	14
Step 4: Create an installation map.....	15
Step 5: Manage the cabling .....	16
Step 6: Connect the microinverters .....	16
Step 7: Terminate the unused end of the IQ Cable.....	17
Step 8: Complete the installation of the junction box .....	18
Step 9: Connect the PV modules .....	18
Step 10: Energize the system .....	19
4.1 Set up and activate monitoring .....	19
<b>5. Troubleshooting</b> .....	<b>20</b>
5.1 Status LED indications and error reporting.....	20
5.2 Troubleshoot an inoperable microinverter.....	21
5.3 Disconnect a microinverter .....	22
5.4 Install a replacement microinverter.....	22
5.5 Enphase IQ Cable planning and ordering.....	23
5.6 Enphase IQ Cable accessories .....	24
<b>6. Technical data</b> .....	<b>25</b>
6.1 Technical considerations.....	25
6.2 Bifacial modules.....	25
6.3 PQ capability curve.....	25
<b>7. Specifications</b> .....	<b>26</b>
7.1 IQ8MC-72-M-INT Microinverter specifications .....	26
7.2 IQ8AC-72-M-INT Microinverter specifications .....	28
7.3 IQ8HC-72-M-INT Microinverter specifications.....	30
7.4 Enphase installation map.....	32
7.5 Sample wiring diagram .....	33
<b>Revision history</b> .....	<b>35</b>

## Important safety information

### Read this first

This manual contains important instructions for use during the installation and maintenance of the IQ8 Series Microinverters.

**IMPORTANT:** Enphase IQ8 Series Microinverters listed in this manual require the IQ Cable. An IQ Gateway is required to monitor the performance and, where required, provide control of the IQ8 Series Microinverters.

### Product labels

The following symbols appear on the **product label** and are described here:



**WARNING:** Hot surface



**DANGER:** Refer to safety instructions



**DANGER:** Risk of electric shock







**Refer to the manual**



**Double insulated**





### Safety and advisory symbols

To reduce the risk of electric shock and to make sure the safe installation and operation of the IQ8 Series Microinverters System, the following safety symbols appear throughout this document to indicate dangerous conditions and important safety instructions.



	<b>DANGER:</b>	This indicates a hazardous situation, which, if not avoided, will result in death or serious injury.
	<b>WARNING:</b>	This indicates a situation where failure to follow instructions may be a safety hazard or cause equipment malfunction. Use extreme caution and follow instructions carefully.
	<b>WARNING:</b>	This indicates a situation where failure to follow instructions may result in burn injury.
	<b>NOTE:</b>	This indicates information that is very important for optimal system operation. Follow instructions closely.









## IQ8 Series Microinverters safety instruction

### General safety

	<b>DANGER:</b> Risk of electric shock. Risk of fire.	Only use electrical system components approved for wet locations. Only competent personnel should install, troubleshoot, or replace Enphase microinverters or IQ Cable and accessories. Make sure that all AC and DC wiring is correct and that none of the AC or DC cables are pinched, shorted, or damaged. Make sure that all AC junction boxes are properly closed. Do not exceed the maximum number of microinverters in an AC branch circuit as listed in the manual. You must protect each microinverter AC branch circuit with a 20 A (single-phase and multi-phase) maximum breaker or fuse, as appropriate.
	<b>DANGER:</b> Risk of electric shock.	Do not use Enphase equipment in a manner not specified by the manufacturer. Doing so may cause death or injury to persons or damage to equipment. Be aware that installation of this equipment includes a risk of electric shock. The DC conductors of this photovoltaic system are ungrounded and may be energized. Always de-energize the AC branch circuit before servicing. Never disconnect the DC or AC connectors under load.
	<b>WARNINGS:</b>	Before installing or using the Enphase microinverter, read all instructions and cautionary markings in the technical description, on the Enphase equipment, and on the photovoltaic (PV) equipment. Do not connect Enphase microinverters to the grid or energize the AC circuit(s) until you have completed all the installation procedures and have received approval from the electrical network operator. When the PV array is exposed to light, DC voltage is supplied to the power conversion equipment (PCE). Risk of equipment damage. Enphase male and female connectors must only be mated with the identical type and brand of male/female connector.
	<b>NOTES:</b>	To ensure optimal reliability and to meet warranty requirements, install the Enphase equipment according to the instructions in this manual. The AC and DC connectors on the cabling are rated as a disconnect only when used with an Enphase microinverter. Protection against lightning and resulting voltage surge must be in accordance with local electrical codes and standards. Perform all electrical installations in accordance with all applicable local electrical codes and standards.

### Microinverter safety

	<b>WARNING:</b> Risk of skin burn.	The chassis of the Enphase microinverter is the heat sink. Under normal operating conditions, the temperature could be 20°C above ambient temperature, but under extreme conditions, the microinverter can reach a temperature of 90°C. To reduce the risk of burns, use caution when working with microinverters.
	<b>DANGER:</b> Risk of fire.	The DC conductors of the PV module must be labelled "PV Wire" or "PV Cable" when paired with the Enphase microinverter.
	<b>DANGER:</b> Risk of electric shock. Risk of fire.	Only competent personnel may connect the Enphase microinverter to the electricity grid. Do not attempt to repair the Enphase microinverter; it contains no user-serviceable parts. If it fails, contact <a href="#">Enphase Support</a> to obtain a return merchandise authorization (RMA) number and start the replacement process. Tampering with or opening the Enphase microinverter will void the warranty.

	<b>WARNING:</b> Risk of equipment damage.	Install the microinverter under the PV module to avoid direct exposure to rain, UV, and other harmful weather events. Always install the microinverter bracket side up. Do not mount the microinverter upside down. Do not expose the AC or DC connectors (on the IQ Cable, PV module, or microinverter) to rain or condensation before the connectors are mated.
		The maximum open circuit voltage of the PV module must not exceed the specified maximum input DC voltage of the Enphase microinverter. Refer to the <a href="#">Enphase Compatibility Calculator</a> to verify PV module electrical compatibility with the microinverter. Use IQ8 Series Microinverters only with compatible PV modules as per <a href="#">Enphase Compatibility Calculator</a> . Using an electrically incompatible PV module voids Enphase warranty.
	<b>WARNING:</b> Risk of equipment damage.	You must match the DC operating voltage range of the PV module with the allowable input voltage range of the Enphase microinverter.  The Enphase microinverter is not protected from damage due to moisture trapped in cabling systems. Never mate microinverters to cables that have been left disconnected and exposed to wet conditions. This voids the Enphase warranty.
	<b>WARNING:</b> Risk of equipment damage.	The Enphase microinverter functions only with a standard, compatible PV module with appropriate fill factor, voltage, and current ratings. Unsupported devices include smart PV modules, fuel cells, wind or water turbines, DC generators, non-Enphase batteries, and other devices. These devices do not behave like standard PV modules, so operation and compliance are not guaranteed. These devices may also damage the Enphase microinverter by exceeding its electrical rating, making the system potentially unsafe.
	<b>NOTES:</b>	The Enphase microinverter has field-adjustable voltage and frequency trip points that may need to be set, depending upon local requirements. Only a competent authorized installer with the permission and following requirements of the local electrical authorities should make adjustments.
	<b>NOTES:</b>	Installers must check the manufacturing date of the products to ensure that the installation date is within one year of the manufactured date of the products. Contact your local distributor to validate the date code.
	<b>NOTES:</b>	Use a G99 approved third party network protection relay for PV systems with system size above 17kW per phase.
<b>Enphase IQ Cable safety</b>		
	<b>DANGER:</b> Risk of electric shock.	Do not install the IQ Terminator while the power is connected.
	<b>WARNING:</b> Risk of electric shock. Risk of fire.	When stripping the sheath from the IQ Cable, make sure the conductors are not damaged. If the exposed conductors are damaged, the system may not function properly.  Do not leave AC connectors on the IQ Cable uncovered for an extended period. You must cover any unused connector with an IQ Sealing Cap.  Make sure protective IQ Sealing Caps have been installed on all unused AC connectors. Unused AC connectors are live when the system is energized.
	<b>WARNING:</b>	Use the IQ Terminator only once. If you open the IQ Terminator following installation, the latching mechanism is destroyed. If the latching mechanism is defective, do not use the IQ Terminator. Do not circumvent or manipulate the latching mechanism.  When installing the IQ Cable, secure any loose cable to avoid the risk of cable insulation abrasion against the roof surface.

**NOTES:**

**When looping the IQ Cable, do not form loops smaller than 120 mm in diameter.**

Provide support for the IQ Cable every 300 mm.

If you need to remove IQ Sealing Cap, you must use the IQ Disconnect Tool.

When installing the IQ Cable and accessories, adhere to the following:

- Do not expose the IQ Terminator cap or cable connections to directed, pressurized liquid (water jets).
- Do not expose the IQ Terminator or IQ Cable to continuous immersion.
- Do not expose the IQ Terminator cap or IQ Cable connections to continuous tension (for example, tension due to pulling or bending the cable near the connection).
- Use only the compatible Enphase IQ connectors.
- Do not allow contamination or debris in the connectors.
- Use the IQ Terminator cap and cable connections only when all parts are present and intact.
- Do not install or use in potentially explosive environments.
- Do not allow the IQ Terminator to come into contact with an open flame.
- Fit the IQ Terminator cap using only the prescribed tools and in the prescribed manner.
- Use only the IQ Terminator to seal the conductor end of the IQ Cable; no other method is allowed.

**DC cable safety**

**NOTES:**

- Ensure proper routing of PV Module DC cable using the clips to prevent the leads from resting on the roof. Do not wrap excess DC cable around the microinverter.
- Avoid direct exposure to sunlight.
- Avoid sharp edges on racking.
- Avoid cable contacting rough surfaces or moving parts within the racking system.
- Avoid overly tight bending radii. The minimum bend radii for the DC cable is 8 X cable outer diameter.
- Avoid overly tight-sized cable clips for routing.

## 1. The Enphase Energy System

The Enphase Energy System includes:

- **IQ8MC, IQ8AC, and IQ8HC Microinverters:** The smart grid-ready IQ8 Series Microinverters convert the DC output of the PV module into grid-compliant AC power.
- **IQ Gateway:** An IQ Gateway (model ENV-S-EM-230, ENV-S-WM-230, or ENV-S-WB-230) is required to monitor solar production, to propagate a grid profile to the microinverters and to provide microinverter control at sites where power export limit (PEL) and /or phase imbalance management (PIM) is required through advanced grid functionalities. The IQ Gateway is a communication device that provides network access to the PV array. The IQ Gateway collects production and performance data from the IQ8 Series Microinverters over on-site AC power lines and transmits the data to Enphase App through a broadband or cellular connection. The IQ Gateway can monitor up to 300 IQ8 Series Microinverters and up to 12 IQ Battery 5P units. For details, refer to [Enphase IQ Gateway Installation and Operations Manual](#).
- **Enphase Installer Portal.** A web-based monitoring and management software: Installers can use Enphase Installer Portal to view detailed performance data, manage multiple PV systems, and remotely resolve issues that might impact system performance. Find out more at <https://enphase.com/en-gb/installers/apps>.
- **Enphase Installer App.** A Mobile app for iOS and Android devices: It allows installers to configure the system while on-site, eliminating the need for a laptop and improving installation efficiency. You can use the app to:
  - Connect to the IQ Gateway over a wireless network for faster system setup and verification.
  - Scan device serial numbers and sync system information with Enphase Installer Portal.
  - View and email a summary report that confirms a successful installation.
- **IQ Battery 5P:** Offers energy storage solutions.
- **IQ Field Wireable Connectors (single-phase: Q-CONN-R-10F and Q-CONN-R-10M; multi-phase: Q-CONN-3P-10M and Q-CONN-3P-10F):** Make connections from any IQ Cable.

This manual describes the safe installation and operation of the IQ8 Series Microinverters.



**NOTE:** To ensure optimal reliability and to meet warranty requirements, Enphase microinverters must be installed according to the instructions in this manual.



## How the Enphase IQ8 Series Microinverters work

The Enphase microinverter maximizes energy production by using a sophisticated maximum power point tracking (MPPT) algorithm. Each Enphase microinverter individually connects to one PV module in your array. This configuration enables an individual MPPT to control each PV module, ensuring that the maximum power available from each PV module is produced regardless of the performance of the other PV modules in the array. While an individual PV module in the array may be affected by shading, soiling, orientation, or PV module mismatch, each Enphase microinverter ensures top performance for its associated PV module.

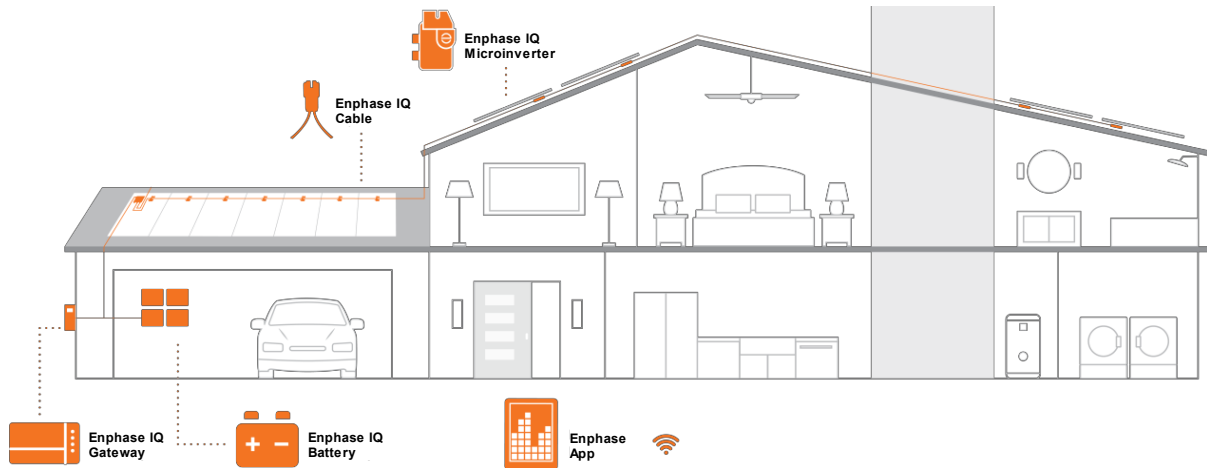

### System monitoring

Once you install the IQ Gateway and provide an internet connection through a broadband router or modem, the IQ8 Series Microinverters automatically begin reporting to Enphase Installer Platform. Enphase Installer Platform presents current and historical system performance trends and informs you of PV system status.

### Optimal reliability

Microinverter systems are inherently more reliable than conventional string inverters. The distributed nature of a microinverter system ensures that there is no single point of system failure in the PV system. Enphase microinverters are designed to operate at full power at ambient temperatures as high as 65°C (149°F).

### Ease of design

PV systems using Enphase microinverters are very simple to design and install. You will not need to perform cumbersome string sizing calculations like conventional string inverters. You can install individual PV modules in any combination of PV module quantity, type, age, and orientation. Each microinverter quickly mounts on the PV racking directly beneath each PV module. Low-voltage DC cables connect from the PV module directly to the co-located microinverter, eliminating the risk of personnel exposure to dangerously high DC voltage.

## 2. Planning for microinverter installation

The IQ8MC, IQ8AC, and IQ8HC Microinverters support PV modules with 54-cell/108-half-cell, 60-cell/120-half-cell, 66-cell/132-half-cell, and 72-cell/144-half-cell configurations. No enforced DC/AC ratio and maximum input power. Modules can be paired if the maximum input voltage is not exceeded and the maximum input current of the inverter at the lowest and highest temperatures is respected.

See [Enphase Compatibility Calculator](#).

IQ8 Series Microinverters install quickly and easily. The microinverter housing is designed for outdoor installation and complies with the IP67 environmental enclosure rating standard.



**IP67 rating definition:** indoor or outdoor use primarily to provide a degree of protection against hose-directed water, the entry of water during occasional temporary submersion at a limited depth, and damage from external ice formation.

The IQ Cable is available with connector spacing options to accommodate the installation of PV modules in portrait or landscape orientation. For IQ Cable ordering information, see [Enphase IQ Cable Planning and Ordering](#).

### Compatibility

The IQ8 Series Microinverters are **electrically compatible** with PV modules, as listed in the following table. For specifications, see [Technical Data](#). You can refer to the IQ Field Wireable Connector at [Enphase Compatibility Calculator](#) to verify PV module electrical compatibility. To ensure **mechanical compatibility**, the microinverter's male and female connectors must only be mated with the identical type and brand of male/female connector.

**IMPORTANT:** The IQ8 Series Microinverters include both AC and DC connectors integrated into the bulkhead. The AC port connects to IQ Cable or Enphase Field Wireable Connector. The DC port has been evaluated by TUV for intermatability with Stäubli made MC4 connectors, whose cable coupler models are "PV-KST4/...-UR, PV-KBT4/...-UR, PV-KBT4-EVO2/...-UR, and PV-KST4-EVO2/...-UR". The DC port of the inverter must be mated with Stäubli made MC4 connectors.



**WARNING:** Risk of fire. The DC conductors of the PV module must be labeled "PV Wire" or "PV Cable" when paired with the Enphase microinverter.

Microinverter model	Connector type	PV module cell count
IQ8MC-72-M-INT	Stäubli MC4	Pair with 54-cell/108-half-cell, 60-cell/120-half-cell, 66-cell/132-half-cell, 72-cell/144-half-cell
IQ8AC-72-M-INT	Stäubli MC4	
IQ8HC-72-M-INT	Stäubli MC4	



**NOTE:** Some Enphase microinverters will not begin exporting power until the IQ Gateway is installed and has detected all the microinverters at the site. In addition, the grid profile needs to be configured, and the IQ Gateway must have propagated these settings to the microinverters. For instructions on this procedure, refer to the IQ Gateway Installation and Operation Manual at <https://enphase.com/en-gb/installers/resources/documentation>

### Earthing considerations

The microinverter has a Class II double-insulated rating, which includes ground fault protection (GFP). To support GFP, use only PV modules equipped with DC cables labeled PV Wire or PV Cable. Refer to local electrical codes and standards for earthing requirements of PV array and racking.

## Branch circuit capacity

Plan your AC branch circuits to meet the following limits for the maximum number of microinverters per branch circuit.

Maximum* IQ8 Series Microinverters per AC branch circuit			
Breaker	IQ8MC	IQ8AC	IQ8HC
20 A Single-phase	11	10	9
20 A Multi-phase	33 (11 per phase)	30 (10 per phase)	27 (9 per phase)
25 A Multi-phase**	39 (13 per phase)	36 (12 per phase)	36 (12 per phase)



**NOTE:** \* Refer to local regulations for overcurrent protection device (OCPD) sizing and define the number of microinverters per branch in your area.

\*\* This breaker option is not available in Europe.

## Electricity network requirements

The IQ8 Series Microinverters work with single-phase or multi-phase grid connections. Measure AC line voltages at the point of connection to confirm that it is within the ranges shown:

Single-phase service		Multi-phase service	
L1 to N	184 to 276 VAC	L1 to L2 to L3	319 to 478 VAC
		L1, L2, L3 to N	184 to 276 VAC

## Conductor lengths and voltage rise

When planning the system, you must select the appropriate AC conductor size to minimize voltage rise. Select the correct conductor size based on the distance from the junction with the microinverter AC branch circuit to the circuit breaker in the electrical panel. Enphase recommends a voltage rise total of less than 2% for the sections from the microinverter AC branch circuit to the circuit breaker in the electrical panel.



**Best practice:** Center-feed the branch circuit to minimize voltage rise in a fully populated branch. This practice substantially reduces the voltage rise as compared with an end-fed branch. To center-feed a branch, divide the circuit into two sub-branch circuits protected by a single OCPD.

## Lightning and surge suppression

Enphase microinverters have integral surge protection, greater than most conventional inverters. However, if the surge has sufficient energy, the protection built into the microinverter can be exceeded, and the equipment can be damaged. For this reason, Enphase recommends that you protect your system with a lightning and/or surge suppression device. In addition to having some level of surge suppression, it is also important to have insurance that protects against lightning and electrical surges.



**NOTE:** Protection against lightning and resulting voltage surge must be in accordance with local electrical codes and standards.

### 3. Parts and tools required

In addition to the microinverters, PV modules, and racking, you will need the following:

#### Enphase equipment

- **IQ Gateway:** Required to monitor production. For installation information, refer to the [IQ Gateway Installation and Operations Manual](#).
- **Enphase Installer App:** Download the Enphase Installer App, open it, and log in to your Enphase account. Use it later to scan the microinverter serial numbers and connect to the IQ Gateway to track system installation progress. To download, go to <https://enphase.com/en-gb/installers/apps> or scan the QR code at right.
- Use a Legrand Phase Coupler (LPC-01) for a multi-phase system for phase coupling if IQ Relay is not installed in the multi-phase system.
- **Tie wraps or cable clips** (ET-CLIP-100 works with both single-phase and multi-phase IQ Cable)
- **IQ Sealing Cap** (Q-SEAL-10): for any unused connectors on the IQ Cable.
- **IQ Terminator** (Q-TERM-R-10 for single-phase or Q-TERM-3P-10 for multi-phase): One for each AC cable segment end; typically, two are needed per branch circuit.
- **IQ Disconnect Tool** (Q-DISC-10)
- **IQ Field Wireable Connectors** (male and female: single-phase; Q-CONN-R-10M and Q-CONN-R-10F; multi-phase: Q-CONN-3P-10M and Q-CONN-3P-10F)
- **IQ Cable:**



Android



iOS

Cable model	Connector spacing	PV module orientation	Connector count per box
<b>Single-phase</b>			
Q-25-10-240	1.3 m	Portrait	240
Q-25-17-240	2.0 m	Landscape (60-cell)	240
Q-25-20-200	2.3 m	Landscape (72-cell)	200
<b>Multi-phase</b>			
Q-25-10-3P-200	1.3 m	Portrait	200
Q-25-17-3P-160	2.0 m	Landscape (60-cell)	160
Q-25-20-3P-160	2.3 m	Landscape (72-cell)	160

- **IQ Raw Cable** (Q-25-RAW-300 for single-phase, Q-25-RAW-3P-300 for multi-phase): Length 300 meters. Raw cable with no connectors (optional).

#### Other items

- AC junction box
- Terminal screwdrivers
- Wire cutters, multimeter
- Torque wrench, sockets, and wrenches for mounting hardware
- Use a G99 approved third party network protection relay for PV systems with system size above 17kW per phase.

## 4. Enphase microinverters installation

Installing the IQ8 Series Microinverters involves several key steps. Each step listed here is detailed in the following pages.

- Step 1:** Position the IQ Cable
- Step 2:** Position the junction box
- Step 3:** Mount the microinverters
- Step 4:** Create an installation map
- Step 5:** Manage the cabling
- Step 6:** Connect the microinverters
- Step 7:** Terminate the unused end of the IQ Cable
- Step 8:** Complete the installation of the junction box
- Step 9:** Connect the PV modules
- Step 10:** Energize the system

### Horizontal mount

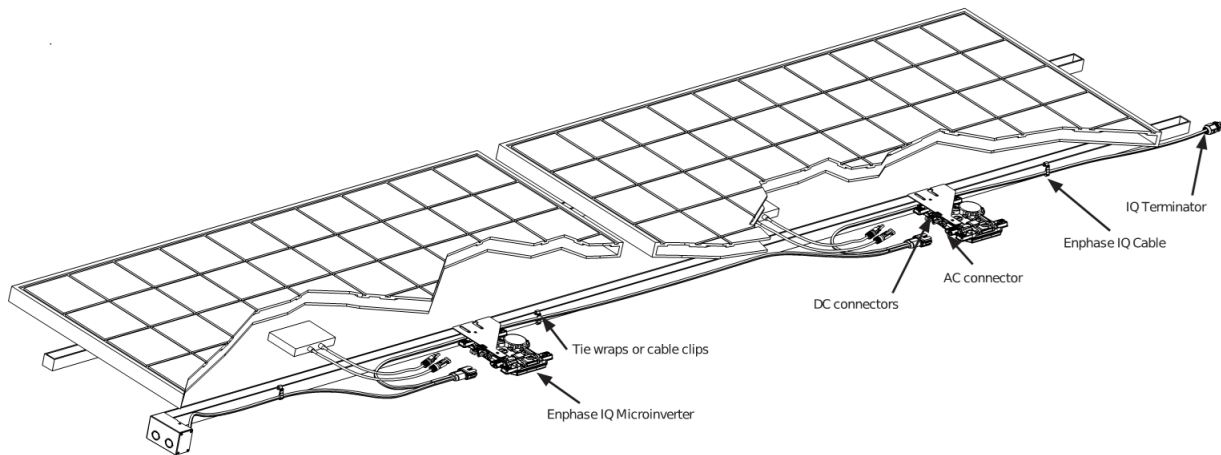

### Vertical mount

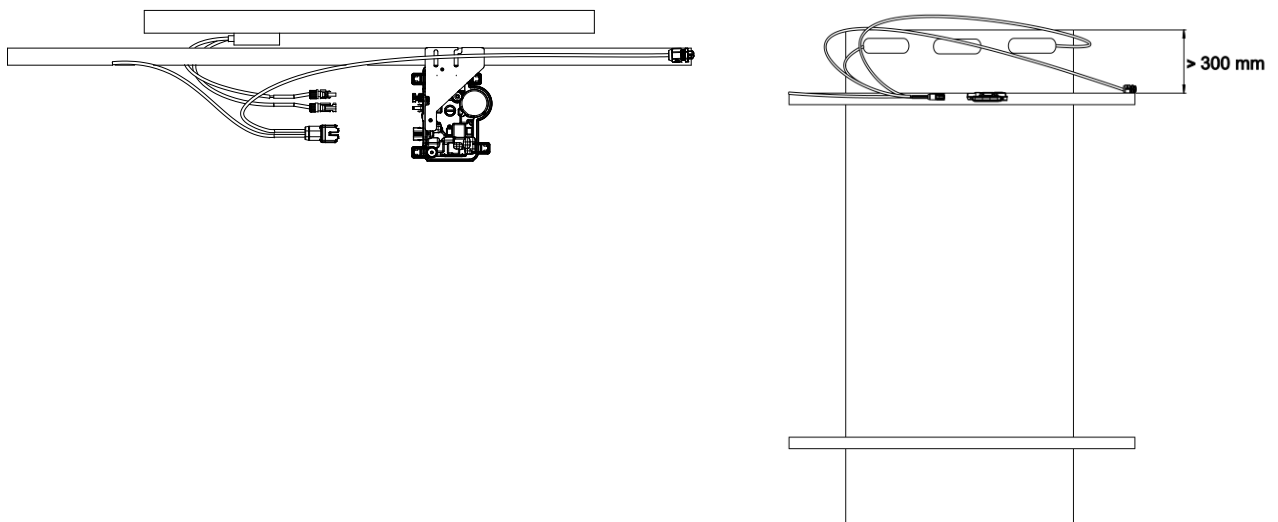

## Step 1: Position the IQ Cable

- A. Plan each cable section to allow connectors on the IQ Cable to align with each PV module. Allow extra length for slack, cable turns, and any obstructions.
- B. Mark the approximate centers of each PV module on the PV racking.
- C. Lay out the cabling along the installed racking for the AC branch circuit.
- D. Cut each section of cable to meet your planned needs.



**WARNING:** When transitioning between rows, secure the cable to the rail to prevent cable damage or connector damage. Do not put the connector at the microinverter under tension.

## Step 2: Position the junction box

- A. Verify that the AC voltage at the site is within range.

Single-phase service		Multi-phase service	
L1 to N	184 to 276 VAC*	L1 to L2 to L3	319 to 478 VAC*
		L1, L2, L3 to N	184 to 276 VAC*

\*Nominal voltage range can be extended beyond nominal if required by the electricity network operator.

- B. Install a junction box/AC isolator at a suitable location.
- C. Provide an AC connection from the junction box/AC isolator back to the electricity network using equipment and practices in accordance with local electrical codes and standards.
- D. For multi-phase installations, verify the IQ Cable wiring colour codes are correctly terminated: L1-Brown, L2-Black, L3-Grey, N-Blue.



**WARNING:** Blue conductor in IQ Cable should be used only for neutral connection. Incorrect termination may irrecoverably damage any connected microinverters.



## Step 3: Mount the microinverters

- A. The microinverters should be mounted beneath the modules either horizontal bracket side up or vertical orientation to the module and must be protected from direct exposure to rain, UV, and other harmful weather events. Please refer to the image below for clearance requirements during vertical mounting.
  - Always place the microinverter under the PV module, protected from direct exposure to rain, sun, and other harmful weather events. Allow a minimum of 19 mm (3/4") between the roof and the microinverter. Also, allow 13 mm (1/2") between the back of the PV module and the top of the microinverter.
  - For vertical mount, also maintain at least 300 mm (12") clearance from the edges of the PV module to protect the microinverter from direct exposure to rain, UV, and other harmful weather events.



**WARNING:** Install the microinverter under the PV module to avoid direct exposure to rain, UV, and other harmful weather events. Do not mount the microinverter upside down.

- B. Torque the microinverter fasteners as follows. Do not over-torque.
  - 6 mm mounting hardware: 5 N m
  - 8 mm mounting hardware: 9 N m

- When using mounting hardware from a third-party manufacturer, use the manufacturer's recommended torque value.

**Horizontal mount**

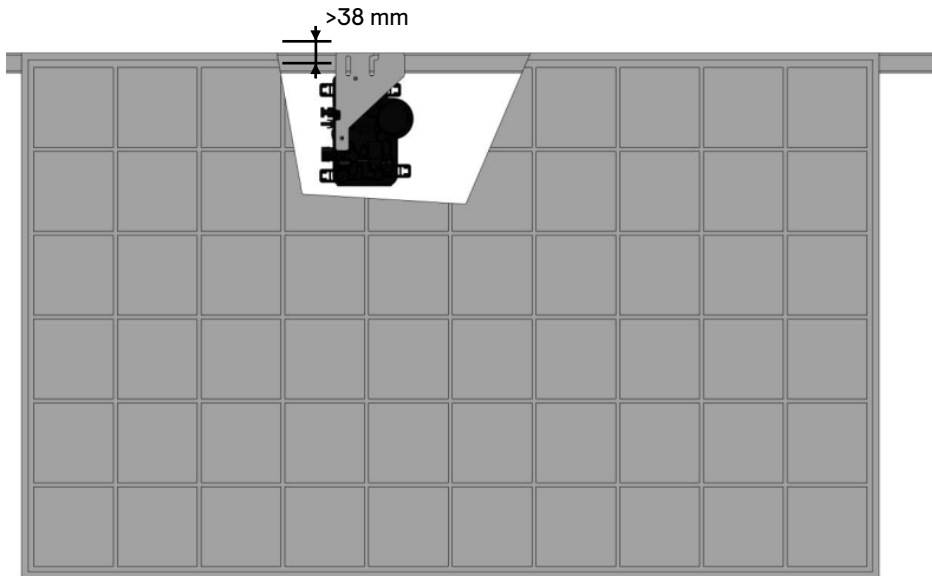

**Vertical mount**

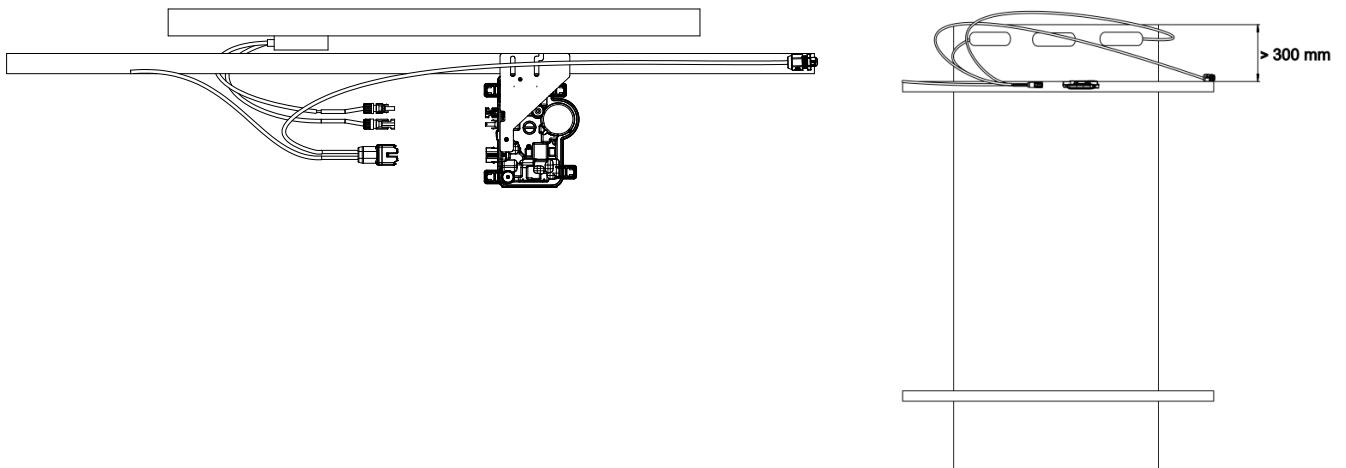

**Step 4: Create an installation map**

The Enphase installation map is a diagram of the physical location of each microinverter in your PV array. Copy or use the [blank map](#) to record microinverter placement for the system or provide your own layout if you require a larger or more intricate installation map.

Each Enphase microinverter, IQ Gateway, and IQ Battery have a removable serial number label. Build the installation map by peeling the serial number labels from the microinverter mounting plates and placing the labels on the map. You should also place the IQ Gateway and IQ Battery serial numbers on the map after installation.

After you have created the installation map, use the Enphase Installer App to record serial numbers and configure the system.

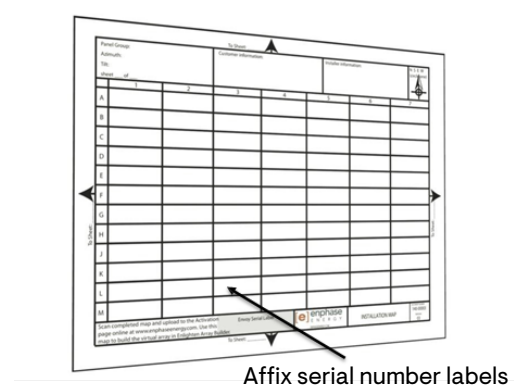

For details, refer to **Detect the Microinverters** in the help topics of the Enphase Installer App.

- A. Peel the removable serial number label from each microinverter and affix it to the respective location on the paper installation map.
- B. Peel the label from the IQ Gateway and any IQ Battery (if installed) and affix it to the installation map.
- C. Always keep a copy of the installation map for your records.

## Step 5: Manage the cabling

- A. Use cable clips or tie wraps to attach the cable to the racking. The IQ Cable must be supported at least every 300 mm.

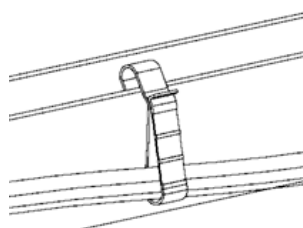

Cable clip

- B. Dress any excess cabling in loops so that it does not contact the roof. Do not form loops smaller than 120 mm in diameter.



**WARNING:** Dress the excess IQ Cable to avoid the risk of cable insulation abrasion against the roof surface.

## Step 6: Connect the microinverters

- A. Connect the IQ Cable to the microinverter. Listen for a click as the connectors engage.
- B. Seal any unused connector on the IQ Cable with IQ Sealing Cap. Listen for a click as caps engage.

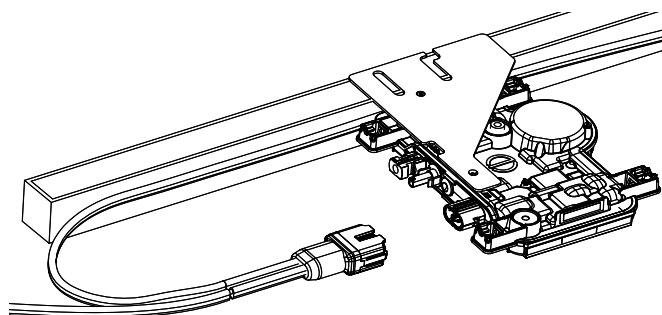

**WARNING:** Risk of electric shock. Risk of fire. Install IQ Sealing Caps on all unused AC connectors, as these connectors become live when the system is energized. IQ Sealing Caps are required for protection against moisture ingress.



**NOTE:** If you need to remove an IQ Sealing Cap, you must use the IQ Disconnect Tool.



## Step 7: Terminate the unused end of the IQ Cable

Terminate the unused end of the IQ Cable as follows.

Single-phase IQ Cable		Multi-phase IQ Cable	
<p>A. Remove 13 mm of the cable sheath from the conductors. Use the IQ Terminator body loop to measure</p>		<p>A. Remove 20 mm of the cable sheath from the conductors</p>	
<p>B. Slide the hex nut onto the cable.</p>		<p>B. Slide the hex nut onto the cable.</p>	
<p>C. Insert the cable into the IQ Terminator body so that the two wires land on opposite sides of the internal separator. The grommet inside the IQ Terminator body must remain in place</p>		<p>C. Insert the cable into the IQ Terminator body so that the four wires land on separate sides of the internal separator. The grommet inside the IQ Terminator body must remain in place</p>	
<p>D. Insert a screwdriver into the slot on the top of the IQ Terminator to hold it in place. Hold the IQ Terminator body stationary with the screwdriver and turn only the hex nut to prevent the conductors from twisting out of the separator. Torque the nut to 7 N m.</p>		<p>D. Bend the wires down into the recesses of the IQ Terminator body and trim as needed. Place the cap over the IQ Terminator body. Insert a screwdriver into the slot on the IQ Terminator cap to hold it in place. Rotate the hex nut with your hand or a wrench until the latching mechanism meets the base. Do not over-torque.</p>	
<p>E. Secure the terminated cable end to the PV racking with a cable clip or tie wrap so that the cable and IQ Terminator are not in contact with the roof surface.</p>		<p>E. Secure the terminated cable end to the PV racking with a cable clip or tie wrap so that the cable and IQ Terminator are not in contact with the roof surface.</p>	



**NOTE:** Turn only the hex nut to prevent conductors from twisting out of the separator.



**WARNING:** The IQ Terminator cannot be re-used. If you unscrew the nut, you must discard the IQ Terminator.

## Step 8: Complete the installation of the junction box

- A. Connect the IQ Cable to the junction box.
- B. Refer to the [electrical diagrams](#) for more information. Conductor colours are listed below:

Single-phase	Multi-phase
Brown – L1 Blue – N	Brown – L1 Black – L2 Grey – L3 Blue – N



**NOTE:** The multi-phase IQ Cable internally rotates L1, L2, and L3 to provide balanced 400 VAC (multi-phase), thus alternating phases between microinverters.



**NOTE:** Minimize the number of unused IQ Cable connectors with multi-phase systems. When cable connectors are left unused on a multi-phase system, it creates a phase imbalance on the branch circuit. If multiple cable connectors are skipped over multiple branch circuits, the imbalance will multiply.

## Step 9: Connect the PV modules



**WARNING:** Electric shock hazard. The DC conductors of this photovoltaic system are not earthed and will be energized when PV modules are exposed to sunlight.

- A. Connect the DC leads of each PV module to the DC input connectors of the corresponding microinverter.
- B. Check the LED on the connector side of the microinverter. The LED flashes green six times when DC power is applied.
- C. Mount the PV modules above the microinverters.

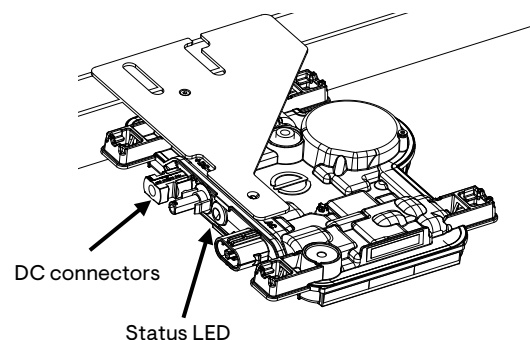

## Step 10: Energize the system

- A. Turn ON the AC disconnect or circuit breaker for the branch circuit.
- B. Your system will ramp up to full producing power after grid profile propagation and device provisioning are completed. It may take 20-30 minutes for full power production based on the number of microinverters in the system.
- C. Check the LED on the connector side of the microinverter:

LED colour	Indicates
Flashing green	Normal operation. AC grid function is normal, and there is communication with the IQ Gateway. IQ8 Series Microinverter's LED will be flashing green only after provisioning.
Flashing orange	The AC grid is normal but there is no communication with the IQ Gateway.
Flashing red	The AC grid is either not present or not within the specification.
Solid red	There is an active <b>DC Resistance Low, Power Off</b> condition. To reset, refer to the IQ Gateway Installation and Operation Manual at: <a href="https://enphase.com/en-gb/installers/resources/documentation">https://enphase.com/en-gb/installers/resources/documentation</a> . If the problem persists, measure resistance between PV+ to EARTH and then PV- to EARTH on the PV module and then inverter. Anything less than ~7 kΩ will trigger the <b>DC Resistance Low, Power Off</b> condition. Usually, the value is in MΩ on the inverter or PV module. Swap out faulty PV module or microinverter.

Refer to the [IQ Gateway Quick Install Guide](#) to install the gateway and set up system monitoring and grid management functions.

### 4.1 Set up and activate monitoring

Refer to the IQ Gateway Quick Install Guide to install the gateway and set up system monitoring and grid management functions. This guide leads you through the following:

- Connecting the gateway
- Detecting devices
- Connecting to Enphase Installer Platform
- Registering the system
- Building the virtual array



**NOTE:** When the electricity network operator requires a grid profile other than the profile set on the microinverter, you must select an appropriate grid profile for your installation. Your system will ramp up to full power after grid profile propagation and device provisioning is completed. It may take 20-30 minutes for full power production based on the number of microinverters in the system.

You can set the grid profile through Enphase Installer Platform, during system registration, or through Enphase Installer App at any time. You must have an IQ Gateway to set or change the grid profile. For more information on setting or changing the grid profile, refer to the IQ Gateway Installation and Operation Manual at <https://enphase.com/en-gb/installers/resources/documentation>

## 5. Troubleshooting

Follow all the safety measures described in this manual. Competent personnel can use the following troubleshooting steps if the PV system does not operate correctly.



**WARNING:** Risk of electric shock. Do not attempt to repair the Enphase microinverter; it contains no user-serviceable parts. If it fails, contact [Enphase Support](#) to obtain a return merchandise authorization (RMA) number and start the replacement process.

### 5.1 Status LED indications and error reporting

The following section describes LED indications.

#### LED operation

LED colour	Indicates
Flashing green	Normal operation. AC grid function is normal and there is communication with the IQ Gateway
Flashing orange	The AC grid is normal but there is no communication with the IQ Gateway
Flashing red	The AC grid is either not present or not within the specification
Solid red	There is an active <b>DC Resistance Low, Power Off</b> condition. To reset, refer to the IQ Gateway Installation and Operation Manual at: <a href="https://enphase.com/en-gb/installers/resources/documentation">https://enphase.com/en-gb/installers/resources/documentation</a> . If the problem persists, measure resistance between PV+ to EARTH and then PV- to EARTH on the PV module and then inverter. Anything less than ~7 kΩ will trigger the <b>DC Resistance Low, Power Off</b> condition. Usually, the value is in MΩ on the inverter or PV module. Swap out faulty PV module or microinverter

The status LED on each microinverter lights green about six seconds after DC power is applied. It remains lit solid for two minutes, followed by six green flashes. After that, red blinks indicate that no grid is present if the system is not yet energized.

Any short red blinks after DC power is first applied to the microinverter indicate a failure during microinverter startup.

#### DC Resistance Low – Power Off condition

For all IQ8 Series Microinverters, a solid red status LED when DC power has been cycled indicates the microinverter has detected a DC Resistance Low – Power Off event. The LED will remain red, and the fault will continue to be reported by the gateway until the error has been cleared.

An insulation resistance (IR) sensor in the microinverter measures the resistance between the positive and negative PV inputs to the ground. If either resistance drops below a threshold of 7kΩ, the microinverter stops power production and raises this condition. This may indicate defective module insulation, defective wiring or connectors, moisture ingress, or a similar problem. Although the cause may be temporary, this microinverter condition persists until the sensor is manually reset.

An IQ Gateway is required to clear this condition. The condition clears on operator command unless its cause is still present.

If a microinverter registers a **DC Resistance Low-Power Off** condition, you can attempt to clear this condition. If the condition does not clear after you perform the following procedure, contact [Enphase Support](#).

Follow the steps below to send a clear message to the microinverter. Note that the condition will not clear after the sensor reset if the cause of the failure is still present. If the condition persists, contact your installer.

## Method: Clear this error using Enphase Installer Platform

- Log in to Enphase Installer Platform and access the system.
- Click the **Events** tab. The next screen shows a current **DC Resistance Low - Power Off** condition for the system.
- Click **DC Resistance Low - Power Off**.
- Where "n" is the number of affected devices, click **n devices (show details)**.
- Click the serial number of the affected microinverter.
- Click **Tasks and Clear GFI** to clear the event.

### Other faults

All other faults are reported to the gateway. Refer to the *IQ Gateway Installation and Operation Manual* at <https://enphase.com/en-gb/installers/resources/documentation> for troubleshooting procedures.

## 5.2 Troubleshoot an inoperable microinverter

To troubleshoot an inoperable microinverter, follow the steps in the order shown:



**WARNING:** Risk of electric shock. Always de-energize the AC branch circuit before servicing. Never disconnect the DC or AC connectors under load.



**WARNING:** The Enphase microinverters are powered by DC power from the PV modules. Make sure you disconnect the DC connections and reconnect the DC power and then watch for the solid green for about six seconds after connection to DC power.

- Make sure AC circuit breakers and isolator switches are closed.
- Check the connection to the grid and verify that the grid voltage is within allowable ranges.
- Verify that AC line voltages at all PV circuit breakers at the electrical panel and sub-panels are within the ranges shown in the following table.
- Verify that the AC line voltage at the junction box for each AC branch circuit is within the ranges shown in the following table:

Single-phase service		Multi-phase service	
L1 to N	184 to 276 VAC*	L1 to L2 to L3	319 to 478 VAC*
		L1, L2, L3 to N	184 to 276 VAC*

\*Nominal voltage range can be extended beyond nominal if required by the electricity network operator.

- Using an IQ Disconnect Tool, disconnect the AC cable for the microinverter in question from the IQ Cable.
- Verify that the grid is present at the microinverter by measuring line-to-line voltage and line-to-ground voltage at the IQ Cable connector.
- Visually check that the AC branch circuit connections (IQ Cable and AC connections) are properly seated. Reset if necessary. Check for any damage, such as rodent damage.
- Make sure that any upstream AC disconnects, as well as the dedicated circuit breakers for each AC branch circuit, are functioning properly and are closed.
- Disconnect and reconnect the DC PV module connectors. The status LED of each microinverter will light solid green for a few seconds after connection to DC power and then flash green six times to indicate normal startup operation about two minutes after connecting to DC power. The LED subsequently resumes normal operation if the grid is present. See [normal LED operation](#).
- Connect a clamp meter to one of the conductors of the DC cables from the PV module to measure the microinverter current. This will be under 1 A if AC is disconnected.
- Verify the PV module DC voltage is within the allowable range shown in [Specifications](#). Refer to the [Enphase Compatibility Calculator](#) to verify PV module electrical compatibility with the microinverter.

- L. Swap DC leads with a known good, adjacent PV module. If the problem moves to the adjacent module after periodically checking the Enphase Installer Platform (this may take up to 30 minutes), it indicates that the PV module is not functioning correctly. If it stays in place, the problem is with the original microinverter. Contact [Enphase Support](#) for help in reading the microinverter data and for help in obtaining a replacement microinverter, if needed.
- M. Check the DC connections between the microinverter and the PV module. The connection may need to be tightened or reseated. If the connection is worn or damaged, it may need replacement.
- N. Verify with your electricity network operator that the line frequency is within range. If the problem persists, contact [Enphase Support](#).

### 5.3 Disconnect a microinverter

If problems remain after following the troubleshooting steps listed previously, contact [Enphase Support](#). If Enphase authorizes a replacement, follow the steps below. To ensure the microinverter is not disconnected from the PV modules under load, follow the disconnection steps in the order shown:

- A. De-energize the AC branch circuit breaker.
- B. IQ Cable AC connectors are tool-removable only. To disconnect the microinverter from the IQ Cable, insert the IQ Disconnect Tool and remove the connector.
- C. Cover the PV module with an opaque cover.
- D. Using a clamp meter, verify that no current flows through the DC cables between the PV module and the microinverter. If the current continues to flow, check that you have completed steps A, B, and C above.



**NOTE:** Take care when measuring DC current, as most clamp meters must be zeroed first, as these tend to drift with time.

- E. Disconnect the PV module DC cable connectors from the microinverter using the IQ Disconnect Tool.
- F. If present, loosen and/or remove any bonding hardware.
- G. Remove the microinverter from the PV racking.



**WARNING:** Risk of electric shock. Risk of fire. Do not leave any connectors on the PV system disconnected for an extended period. If you do not plan to replace the microinverter immediately, you must cover any unused connector with an IQ Sealing Cap.

### 5.4 Install a replacement microinverter

- A. When the replacement microinverter is available, verify that the AC branch circuit breaker is de-energized.
- B. Mount the microinverter horizontally bracketed side up or vertically
  - Always place the microinverter under the PV module, protected from direct exposure to rain, sun, and other harmful weather events. Allow a minimum of 19 mm between the roof and the microinverter. Also, allow 13 mm between the back of the PV module and the top of the microinverter.
  - For vertical mount, also maintain > 300 mm clearance from the edges of the PV module to protect the microinverter from direct exposure to rain, UV, and other harmful weather events.



**WARNING:** Risk of equipment damage. Mount the microinverter under the PV module.

- Install the microinverter under the PV module to avoid direct exposure to rain, UV, and other harmful weather events.

- Always install the microinverter bracket side up for horizontal mount installations.
  - Do not mount the microinverter upside down.
  - Do not expose the AC or DC connectors (on the IQ Cable connection, PV module, or the microinverter) to rain or condensation before the connectors are mated.
- C. Torque the mounting fasteners to the values shown. Do not over-torque.
- 6 mm mounting hardware: 5 N m
  - 8 mm mounting hardware: 9 N m
  - When using a third-party manufacturer's mounting hardware, use the manufacturer's recommended torque value.
- D. Connect the microinverter to the IQ Cable connector. Listen for a click as connectors engage.
- E. Connect the DC leads of each PV module to the DC input connector of the microinverter.
- F. Re-mount the PV module above the microinverter.
- G. Energize the AC branch circuit breaker and verify the operation of the replacement microinverter by checking the status LED on the connector side of the microinverter.
- H. Use the Enphase Installer App to retire the old microinverter serial number from the IQ Gateway database. In Enphase Installer App, once connected to the IQ Gateway:
- a. Tap **Devices & Array > IQ Microinverters & Array > IQ Microinverter Serial Number**.
  - b. Tap **RETIRE** to retire the old microinverter serial number from the IQ Gateway database.
  - c. Add the new microinverter serial number to the gateway database by scanning the barcode using Enphase Installer App and your device camera.
  - d. Tap **Devices & Array > IQ Microinverters & Array > ADD DEVICES**. Scan the IQ8 Series Microinverter's barcode and assign it to the array.
- or
- Go to **Service > Request return and install replacement > Install Replacement**. Enter the original device serial number and replacement device serial number and submit.
- I. Start the provisioning process for the newly added microinverter using Enphase Installer App and by connecting Enphase Installer App to IQ Gateway in AP mode. You can then **Start Provisioning Devices** through Enphase Installer App.
- J. Ship the old microinverter to Enphase using the supplied return-shipping label.

## 5.5 Enphase IQ Cable planning and ordering

The IQ Cable is a continuous length of double-insulated, outdoor-rated cable with integrated connectors for microinverters. These connectors are preinstalled along the IQ Cable at intervals to accommodate varying PV module widths. The microinverters plug directly into the cable connectors.

### Connector spacing options

IQ Cable is available in three connector spacing options. The gap between connectors on the cable can be 1.3 meters, 2.0 meters, or 2.3 meters. The 1.3 meters spacing is best suited for connecting PV modules installed in portrait orientation, while the 2.0 meter and 2.3 meters spacings allow you to install in landscape orientation for PV modules with 54-cell/108-half-cell, 60-cell/120-half-cell, 66-cell/132-half-cell, 72-cell/144-half-cell configurations.

## IQ Cable options

Ordering options include:

Cable model	Connector spacing	PV module orientation	Connector count per box
<b>Single-phase</b>			
Q-25-10-240	1.3 m	Portrait	240
Q-25-17-240	2.0 m	Landscape (60-cell)	240
Q-25-20-200	2.3 m	Landscape (72-cell)	200
<b>Multi-phase</b>			
Q-25-10-3P-200	1.3 m	Portrait	200
Q-25-17-3P-160	2.0 m	Landscape (60-cell)	160
Q-25-20-3P-160	2.3 m	Landscape (72-cell)	160

The cabling system is flexible enough to adapt to almost any solar design. To determine the cable type you need, apply the following considerations:

- When mixing PV modules in both portrait and landscape orientation, you may need to transition between cable types. See the preceding table for available cable types.
- To transition between cable types, install a Field Wireable Connector pair.
- In situations where portrait modules are widely spaced, you may need to use landscape-spaced cables for the portrait-oriented PV modules and create loops of excess cable, if needed.



**WARNING:** Do not form loops smaller than 120 mm in diameter.

## 5.6 Enphase IQ Cable accessories

The IQ Cable is available with several accessory options for ease of installation, including:

- **IQ Raw Cable** (Q-25-RAW-300 for single-phase, Q-25-RAW-3P-300 for multi-phase): Length 300 meters. Raw cable with no connectors (optional).
- **IQ Field Wireable Connectors** (male and female; single-phase: Q-CONN-R-10M and Q-CONN-R-10F; multi-phase: Q-CONN-3P-10M and Q-CONN-3P-10F).
- **IQ Cable Clips**: (ET-CLIP-100) Used to fasten cabling to the racking or to secure looped cabling.
- **IQ Disconnect Tool** (Q-DISC-10): Disconnect Tool for IQ Cable connectors, DC connectors, and AC module mount.
- **IQ Sealing Cap** (female): (Q-SEAL-10) One needed to cover each unused connector on the cabling.
- **IQ Terminator** (Q-TERM-R-10 for single-phase or Q-TERM-3P-10 for multi-phase) One for each AC cable segment end; typically, two are needed per branch circuit.
- Use a Legrand Phase Coupler (LPC-01) for a multi-phase system for phase coupling if IQ Relay is not installed in the multi-phase system.



## 6. Technical data

### 6.1 Technical considerations

Be sure to apply the following when installing the Enphase IQ8 Series Microinverters System:



**WARNING:** Risk of equipment damage. You must match the DC operating voltage range of the PV module with the allowable input voltage range of the Enphase microinverter.

**WARNING:** Risk of equipment damage. The maximum open circuit voltage of the PV module must not exceed the specified maximum input voltage of the Enphase microinverter.

- PV modules must have conductors labeled "PV Wire" or "PV Cable".
- Verify that the voltage and current specifications of the PV module match those of the microinverter.
- The maximum short circuit current rating of the PV module must be equal to or less than the maximum input DC short circuit current rating of the microinverter.

The output voltage and current of the PV module depend on the quantity, size, and temperature of the PV cells, as well as the insulation on each cell. The highest PV module output voltage occurs when the temperature of the cells is the lowest, and the PV module is at an open circuit (not operating).

### 6.2 Bifacial modules

Enphase IQ8 Series Microinverters are compatible with bifacial PV modules if the temperature-adjusted electrical parameters (maximum power, voltage, and current) of the modules, considering the electrical parameters, including the bifacial gain, are within the allowable microinverter input parameters range. In evaluating the amount of bifacial gain, follow the recommendations of the module manufacturers.

### 6.3 PQ capability curve

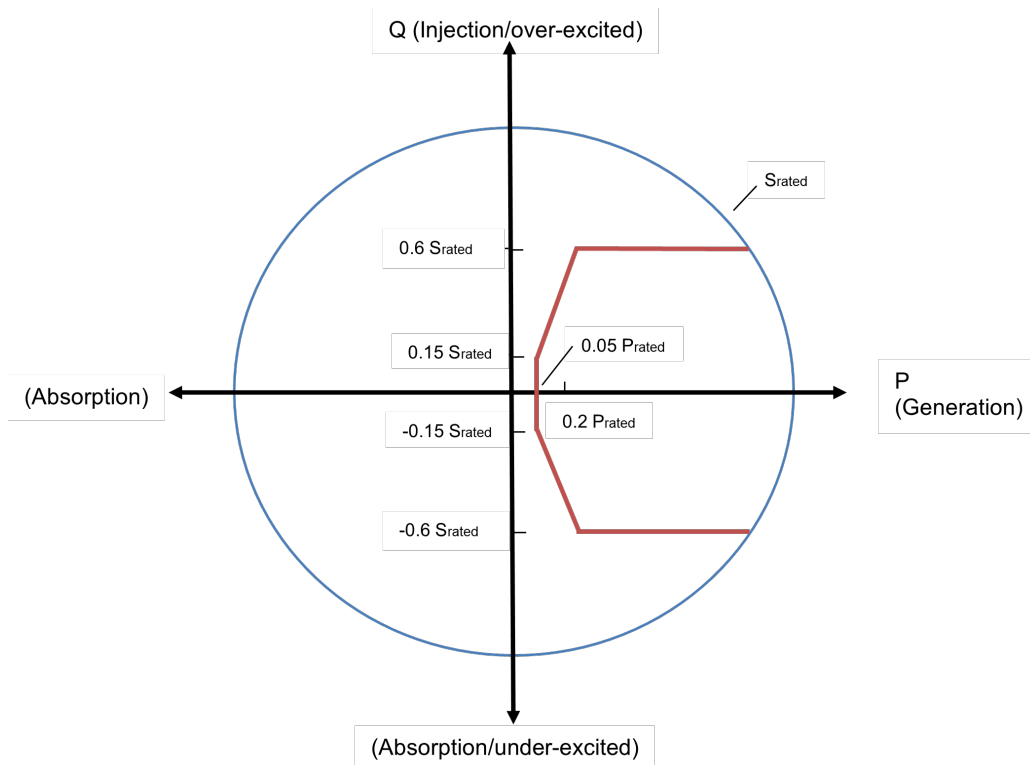

## 7. Specifications

The specifications for the following IQ8 Series Microinverters are provided in the table below.

- IQ8MC-72-M-INT Microinverters
- IQ8AC-72-M-INT Microinverters
- IQ8HC-72-M-INT Microinverters

### 7.1 IQ8MC-72-M-INT Microinverter specifications

IQ8MC-72-M-INT Microinverter parameters				
Topic	Unit	Minimum	Typical	Maximum
<b>DC parameters</b>				
Maximum input power <sup>1</sup>	W	480		
Minimum/Maximum MPP voltage	V	25		45
Minimum/Maximum operating voltage	V	18		49
Minimum/Maximum input voltage	V	18		60
Startup input voltage	V	22		
Maximum input current ( $I_{dcmax}$ )	A			14
Maximum short-circuit DC input current ( $I_{scmax}$ )	A			25 <sup>2</sup>
Protective class (all ports)			II	
PV array configuration	1x1 ungrounded array; no additional DC side protection required; AC side protection requires max 20 A (single-phase or multi-phase)			
<b>AC parameters</b>				
Rated power	W	325		
Maximum apparent power	VA	330		
Power factor range		0.8 leading – 0.8 lagging		
Minimum/Nominal/Maximum grid voltage <sup>3</sup>	Vrms	184	230	276
Maximum output current	Arms			1.43
Nominal frequency	Hz		50	
Minimum/Maximum frequency	Hz	45		55
Maximum AC output over current protection device	A	20 A (single-phase & multi-phase)		
High AC voltage trip limit accuracy	%	±1.0		
Low AC voltage trip limit accuracy	%	±1.0		
Frequency trip limit accuracy	Hz	±0.1		
Trip time accuracy (for trip times or delays < 5 sec.)	±ms			33
Trip time accuracy (for trip times or delays ≥ 5 sec.)	%			1
Overvoltage class AC port			III	
Power factor setting			1.0	

1. No enforced DC/AC ratio. See [Enphase Compatibility Calculator](#)
2. Maximum short circuit current for modules ( $I_{sc}$ ) allowed to be paired with IQ8 Series Microinverters: 20 A (Calculated with 1.25 safety factor as per IEC 62548)
3. The nominal voltage range can be extended beyond nominal if required by the electricity network operator.

IQ8MC-72-M-INT Microinverter parameters				
Topic	Unit	Minimum	Typical	Maximum
<b>Miscellaneous parameters</b>				
Maximum <sup>4</sup> microinverters per 20 A (max) AC branch circuit 230 VAC (single-phase)/400 VAC (multi-phase)		11 (L+N)/33 (3L+N)		
European weighted efficiency	%	96.7		
Total harmonic distortion	%			<5
Ambient air temperature range	°C	-40		+60
Nighttime power loss	mW			50
Storage temperature range	°C	-40		+85
<b>Features and specifications</b>				
Compatibility	54-cell/108-half-cell, 60-cell/120 half-cell, 66-cell/132-half-cell, 72-cell/144-half-cell			
Dimensions (without mounting brackets)	212 mm (8.3") x 175 mm (6.9") x 30.2 mm (1.2")			
DC connector type	Stäubli MC4			
Weight	1.1 kg			
IP Rating	Outdoor - IP67			
Torque specifications for fasteners (do not over torque)	<ul style="list-style-type: none"> <li>• 6 mm mounting hardware: 5 N m</li> <li>• 8 mm mounting hardware: 9 N m</li> </ul>			
Cooling	Natural convection - No fans			
Relative Humidity range	4% to 100% (condensing)			
Approved for wet locations	Yes			
Altitude	< 2600 m			
Pollution degree	PD3			
Standard Warranty Term	<a href="https://enphase.com/warranty">https://enphase.com/warranty</a>			
<b>IQ8MC-72-M-INT Microinverter parameters</b>				
Compliance	<b>Grid compliance:</b> G98, G99, G100 <b>Safety:</b> EN IEC 62109-1, EN IEC 62109-2 <b>EMC:</b> EN IEC 61000-3-2, 61000-3-3, 61000-6-2, 61000-6-3, EN IEC 50065-1, 50065-2-1 EN55011 (At STC within MPP range)			
Earthing	The DC circuit meets the requirements for ungrounded PV arrays. Ground fault protection (GFP) is integrated into the class II double-insulated microinverter			
Monitoring	Enphase Installer Platform and Enphase App monitoring options. Both options require an IQ Gateway			
Communication	Power line communication (PLC)			

4. Limits may vary. Refer to local requirements to define the number of microinverters per branch in your area.

## 7.2 IQ8AC-72-M-INT Microinverter specifications

IQ8AC-72-M-INT Microinverter parameters				
Topic	Unit	Minimum	Typical	Maximum
<b>DC parameters</b>				
Maximum input power <sup>1</sup>	W	530		
Minimum/Maximum MPP voltage	V	28		45
Minimum/Maximum operating voltage	V	18		49
Minimum/Maximum input voltage	V	18		60
Startup input voltage	V	22		
Maximum input current ( $I_{dmax}$ )	A			14
Maximum short-circuit DC input current ( $I_{scmax}$ )	A			25 <sup>2</sup>
Protective class (all ports)			II	
PV array configuration	1x1 ungrounded array; no additional DC side protection required; AC side protection requires max 20 A (single-phase or multi-phase)			
<b>AC parameters</b>				
Rated power	W	360		
Maximum apparent power	VA	366		
Power factor range		0.8 leading – 0.8 lagging		
Minimum/Nominal/Maximum grid voltage <sup>3</sup>	$V_{rms}$	184	230	276
Maximum output current	Arms			1.59
Nominal frequency	Hz		50	
Minimum/Maximum frequency	Hz	45		55
Maximum AC output over current protection device	A	20 A (single-phase & multi-phase)		
High AC voltage trip limit accuracy	%	±1.0		
Low AC voltage trip limit accuracy	%	±1.0		
Frequency trip limit accuracy	Hz	±0.1		
Trip time accuracy (for trip times or delays < 5 sec.)	±ms			33
Trip time accuracy (for trip times or delays ≥ 5 sec.)	%			1
Overvoltage class AC port			III	
Power factor setting			1.0	
<b>Miscellaneous parameters</b>				
Maximum <sup>4</sup> microinverters per 20 A (max) AC branch circuit 230 VAC (single-phase)/400 VAC (multi-phase)		10 (L+N)/30 (3L+N)		
European weighted efficiency	%	96.6		
Total harmonic distortion	%			<5
Ambient air temperature range	°C	-40		+60
Nighttime power loss	mW			50
Storage temperature range	°C	-40		+85

1. No enforced DC/AC ratio. See [Compatibility Calculator](#).
2. Maximum short circuit current for modules ( $I_{sc}$ ) allowed to be paired with IQ8 Series Microinverters: 20 A (calculated with 1.25 safety factor as per IEC 62548).
3. The nominal voltage range can be extended beyond nominal if required by the electricity network operator.
4. Limits may vary. Refer to local requirements to define the number of microinverters per branch in your area.

IQ8AC-72-M-INT Microinverter parameters	
Features and specifications	
Compatibility	54-cell/108-half-cell, 60-cell/120-half-cell, 66-cell/132-half-cell, 72-cell/144-half-cell
Dimensions (without mounting brackets)	212 mm (8.3") x 175 mm (6.9") x 30.2 mm (1.2")
DC connector type	Stäubli MC4
Weight	1.1 kg
IP Rating	Outdoor - IP67
Torque specifications for fasteners (Do not over torque)	<ul style="list-style-type: none"> <li>• 6 mm mounting hardware: 5 N m</li> <li>• 8 mm mounting hardware: 9 N m</li> </ul>
Cooling	Natural convection - no fans
Relative Humidity range	4% to 100% (condensing)
Approved for wet locations	Yes
Altitude	< 2600 m
Pollution degree	PD3
Standard Warranty Term	<a href="http://enphase.com/warranty">http://enphase.com/warranty</a>
IQ8AC-72-M-INT Microinverter parameters	
Compliance	<p><b>Grid compliance:</b> G98, G99, G100</p> <p><b>Safety:</b> EN IEC 62109-1, EN IEC 62109-2</p> <p><b>EMC:</b> EN IEC 61000-3-2, 61000-3-3, 61000-6-2, 61000-6-3, EN IEC 50065-1, 50065-2-1 EN55011 (At STC within MPP range)</p>
Earthing	The DC circuit meets the requirements for ungrounded PV arrays. Ground fault protection (GFP) is integrated into the class II double-insulated microinverter
Monitoring	Enphase Installer Platform and Enphase App monitoring options. Both options require an IQ Gateway
Communication	Power line communication (PLC)

### 7.3 IQ8HC-72-M-INT Microinverter specifications

IQ8HC-72-M-INT Microinverter parameters				
Topic	Unit	Minimum	Typical	Maximum
<b>DC parameters</b>				
Maximum input power <sup>1</sup>	W	560		
Minimum/Maximum MPP voltage	V	29.5		45
Minimum/Maximum operating voltage	V	18		49
Minimum/Maximum input voltage	V	18		60
Startup input voltage	V	22		
Maximum input current ( $I_{dcmax}$ )	A			14
Maximum short-circuit DC input current ( $I_{scmax}$ )	A			25 <sup>2</sup>
Protective class (all ports)			II	
PV array configuration	1x1 ungrounded array; no additional DC side protection required; AC side protection requires max 20 A (single-phase or multi-phase)			
<b>AC parameters</b>				
Rated power	W	380		
Maximum apparent power	VA	384		
Power factor range		0.8 leading – 0.8 lagging		
Minimum/Nominal/Maximum grid voltage <sup>3</sup>	$V_{rms}$	184	230	276
Maximum output current	Arms			1.67
Nominal frequency	Hz		50	
Minimum/Maximum frequency	Hz	45		55
Maximum AC output over current protection device	A	20 A (single-phase & multi-phase)		
High AC voltage trip limit accuracy	%	±1.0		
Low AC voltage trip limit accuracy	%	±1.0		
Frequency trip limit accuracy	Hz	±0.1		
Trip time accuracy (for trip times or delays < 5 sec.)	±ms			33
Trip time accuracy (for trip times or delays ≥ 5 sec.)	%			1
Overvoltage class AC port			III	
Power factor setting			1.0	
<b>Miscellaneous parameters</b>				
Maximum <sup>4</sup> microinverters per 20 A (max) AC branch circuit 230 VAC (single-phase)/400 VAC (multi-phase)		9 (L+N)/27 (3L+N)		
European weighted efficiency	%	96.8		
Total harmonic distortion	%			<5
Ambient air temperature range	°C	-40		+60
Nighttime power loss	mW			50
Storage temperature range	°C	-40		+85

1. No enforced DC/AC ratio. See [Compatibility Calculator](#).
2. Maximum short circuit current for modules ( $I_{sc}$ ) allowed to be paired with IQ8 Series Microinverters: 20 A (Calculated with 1.25 safety factor as per IEC 62548).
3. The nominal voltage range can be extended beyond nominal if required by the electricity network operator.
4. Limits may vary. Refer to local requirements to define the number of microinverters per branch in your area.

IQ8HC-72-M-INT Microinverter parameters	
Features and specifications	
Compatibility	54-cell/108-half-cell, 60-cell/120-half-cell, 66-cell/132-half-cell, 72-cell/144-half-cell
Dimensions (without mounting brackets)	212 mm (8.3") x 175 mm (6.9") x 30.2 mm (1.2")
DC connector type	Stäubli MC4
Weight	1.1 kg
IP Rating	Outdoor - IP67
Torque specifications for fasteners (Do not over torque)	<ul style="list-style-type: none"> <li>• 6 mm mounting hardware: 5 N m</li> <li>• 8 mm mounting hardware: 9 N m</li> </ul>
Cooling	Natural convection - No fans
Relative Humidity range	4% to 100% (condensing)
Approved for wet locations	Yes
Altitude	< 2600 m
Pollution degree	PD3
Standard Warranty Term	<a href="http://enphase.com/warranty">http://enphase.com/warranty</a>
IQ8HC-72-M-INT Microinverter parameters	
Compliance	<p><b>Grid compliance:</b> G98, G99, G100</p> <p><b>Safety:</b> EN IEC 62109-1, EN IEC 62109-2</p> <p><b>EMC:</b> EN IEC 61000-3-2, 61000-3-3, 61000-6-2, 61000-6-3, EN IEC 50065-1, 50065-2-1 EN55011 (At STC within MPP range)</p>
Earthing	The DC circuit meets the requirements for ungrounded PV arrays. Ground fault protection (GFP) is integrated into the class II double-insulated microinverter.
Monitoring	Enphase Installer Platform and Enphase App monitoring options. Both options require an IQ Gateway
Communication	Power line communication (PLC)

### 7.4 Enphase installation map

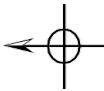
Panel Group: Azimuth Tilt: Sheet ____ / ____	Client:	Installer:	N S E W 	1	2	3	4	5	6	7		
				A								
				B								
				C								
				D								
				E								
				F								
G												
H												
J												
K												



**NOTES:**

- These schematics are examples only. These schematics provide recommendations to assist the system designer and installer.
- The design and installation of the photovoltaic power plant must be carried out in accordance with local electrical standards in the country of installation and must be carried out by competent personnel.
- Before installing any PV equipment, check the phase-to-neutral voltage at the point of connection. The operating voltage must be within a range acceptable for the 230 V microinverters.
- The lengths and cross sections of AC cable (between the end of the IQ Cable and the electrical panel) must be determined in accordance with the electrical standards in force in the country of installation. It is recommended that the voltage drop on this cable does not exceed 1%, and that overall voltage drop in the PV circuit from the point of connection to the most remote microinverter does not exceed 2%.
- The 2.5 mm<sup>2</sup> IQ Cable is usually protected by a 20 A B curve circuit breaker.
- The equipotential bonding between PV module frames, array mounting structure and the metal microinverter mounting brackets must be installed in accordance with local electrical standards...
- Surge protection devices (SPD) and Residual Current Devices (RCD) must be installed in accordance with local electrical standards. Enphase microinverters have an internal surge protection.
- Enphase microinverters have an integrated High Frequency transformer which provides galvanic separation between DC and AC parts. Where local electrical standards require RCD protection, a Type AC device can be used.
- Utility meter may be located inside the main panel or as a standalone device.

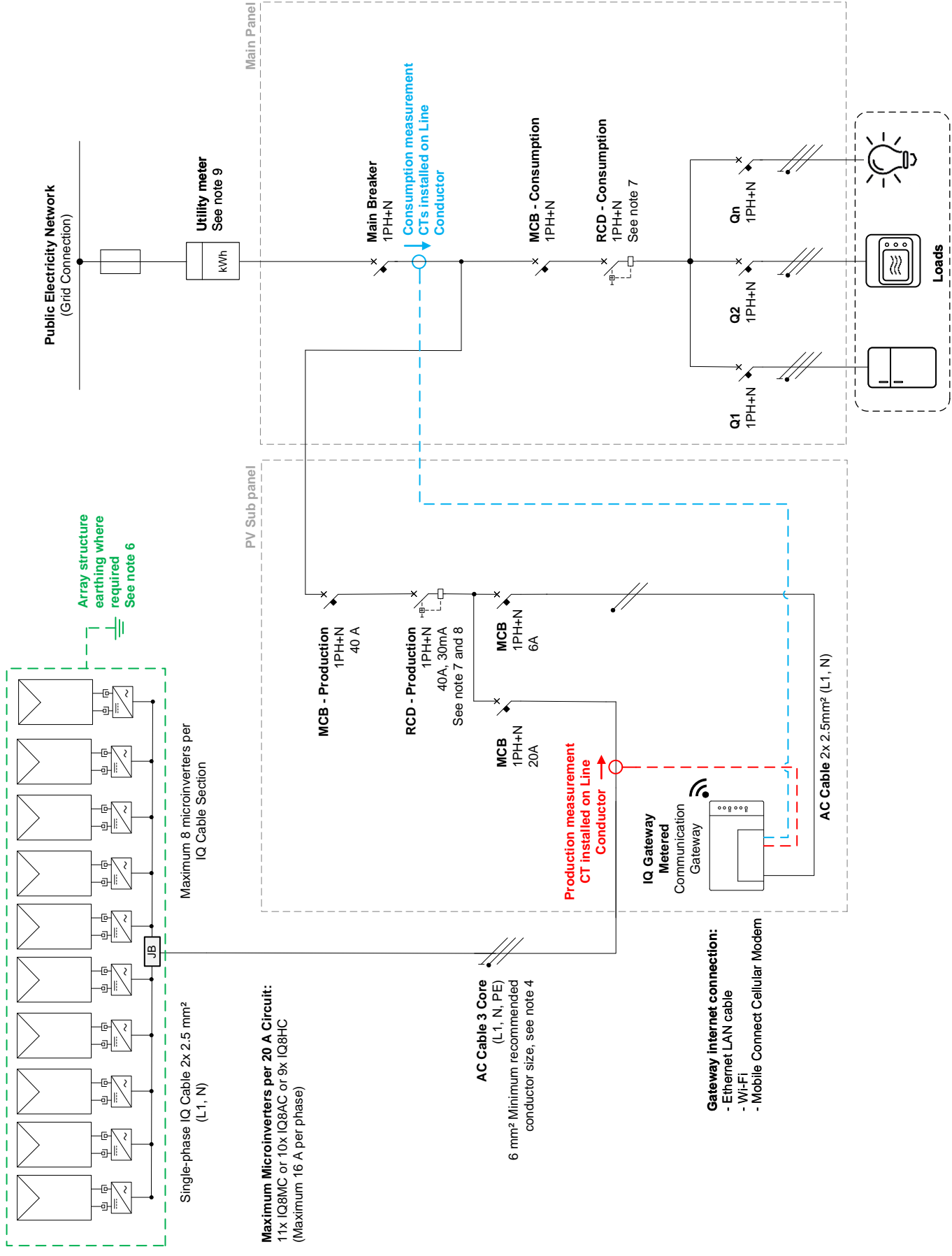

**DRAWING No.:** EN-IQ8-1PHN  
**DRAWING Name:** Electrical diagram example: Single-phase IQ8 Series Microinverters (IQ8MC or IQ8AC or IQ8HC) Grid Tied PV System

**NOTES:**

- These schematics are examples only. These schematics provide recommendations to assist the system designer and installer.
- The design and installation of the photovoltaic power plant must be carried out in accordance with local electrical standards in the country of installation and must be carried out by competent personnel.
- Before installing any PV equipment, check the phase-to-neutral voltage at the point of connection. The operating voltage must be within a range acceptable for the 230 V microinverters.
- The lengths and cross sections of AC cable (between the end of the IQ Cable and the electrical panel) must be determined in accordance with the electrical standards in force in the country of installation. It is recommended that the voltage drop on this cable does not exceed 1% and that overall voltage drop in the PV circuit from the point of connection to the most remote microinverter does not exceed 2%.
- The 2.5 mm<sup>2</sup> IQ Cable is usually protected by a 20 A B curve circuit breaker.
- The equipotential bonding between PV module frames, array mounting structure and the metal microinverter mounting brackets must be installed in accordance with local electrical standards.
- Surge protection devices (SPD) and Residual Current Devices (RCD) must be installed in accordance with local electrical standards. Enphase microinverters have an internal surge protection.
- Enphase microinverters have an integrated High Frequency transformer which provides galvanic separation between DC and AC parts. Where local electrical standards require RCD protection, a Type AC device can be used.
- Utility meter may be located inside the main panel or as a standalone device.
- Use a G99 approved third party network protection relay for PV systems with system size above 17kW per phase.

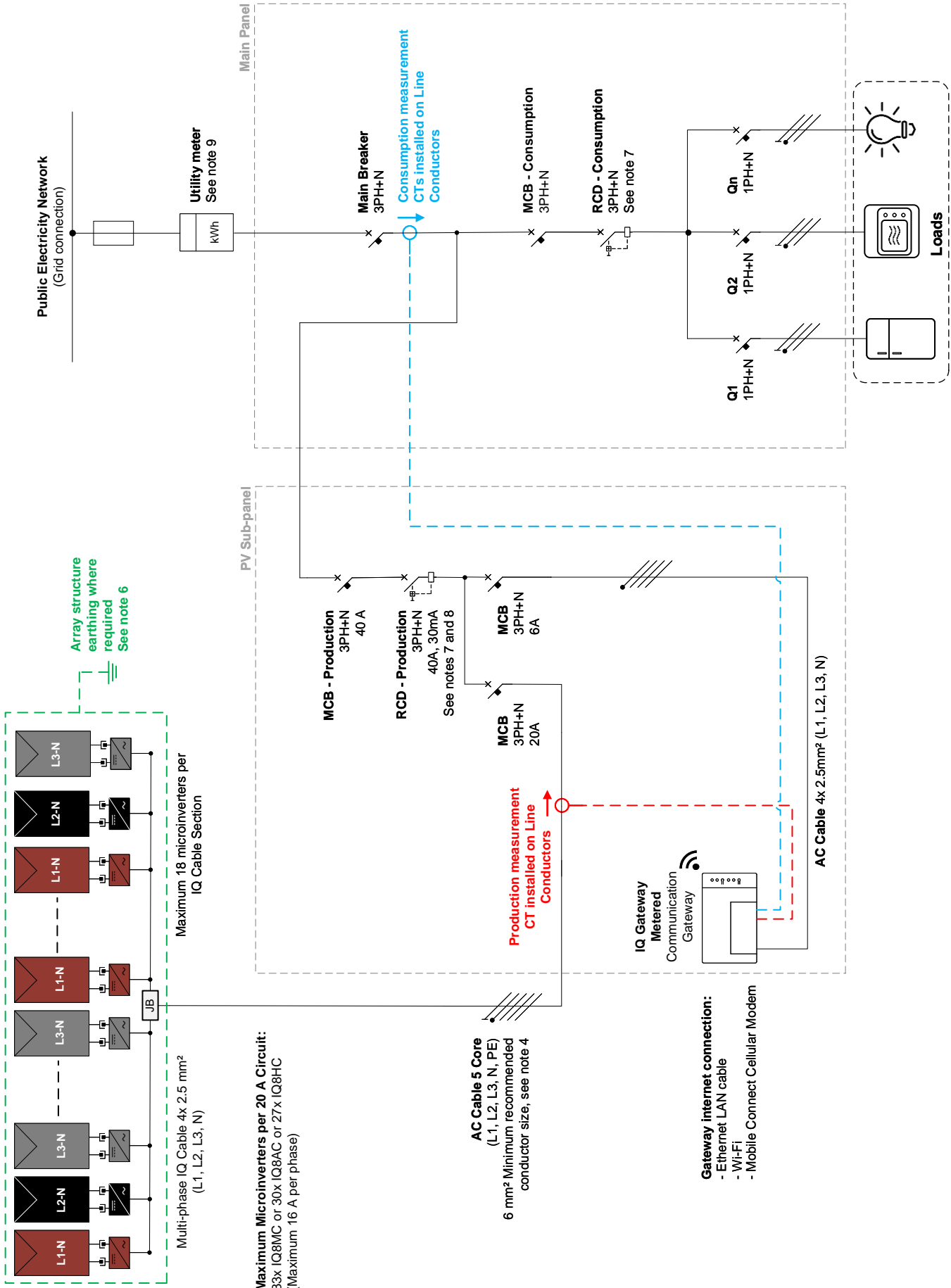

**Maximum Microinverters per 20 A Circuit:**  
33x IQ8MC or 30x IQ8AC or 27x IQ8HC  
(Maximum 16 A per phase)

**AC Cable 5 Core**  
(L1, L2, L3, N, PE)  
6 mm<sup>2</sup> Minimum recommended conductor size, see note 4

**Gateway internet connection:**  
- Ethernet LAN cable  
- Wi-Fi  
- Mobile Connect Cellular Modem

## Revision history

Revision	Date	Description
IOM-00029-1.0	September 2023	Initial release