



INSTALLATION MANUAL

COMMERCIAL ALL IN ONE

V1.0 08.01.25 | UK

GIV-SME-30/69-ID

This manual covers the product information, installation, commissioning, operation and maintenance of the GivEnergy Commercial All in One, referred to as CAIO for the remainder of this manual and its sub-components.

- GIV-SME-30/69-ID - the CAIO cabinet
- GIV-SME-AIO-HVB - master battery BMS and protection
- GIV-SME-AIO-7.6 - 7.68kWh battery packs (9 per CAIO)
- GIV-EMS-C - Energy management system (1 per system)

It is critical that the below instructions are fully read and understood.

- Only trained and qualified electricians can install or maintain the system
- The CAIO cabinet and batteries are heavy and will require lifting equipment in all circumstances
- Before removing any covers or batteries the CAIO cabinet must be isolated from all sources, including the AC supply and Batteries if fitted as high DC voltage may be present even when turned off

Signs and symbols in this guide



Pay particular attention to this instruction, risk of damage to the product or personal injury.

Required tools and equipment

- Gloves
- Screwdrivers
- Socket/Spanner set
- Lifting equipment
- Electrical test meter
- Laptop
- Ethernet (RJ45) cable

INTRODUCTION TO THE GIVENERGY CAIO

The CAIO is designed to be an easy to install expandable energy storage system to fill the gap between residential and larger commercial storage systems. Each CAIO contains 69kWh of batteries and 30kW of inverter built-in to a slimline cabinet much like a computer server cabinet.

Each system can have between 1 and 6 CAIO's connected together to give the following flexible size options;

- 69kWh / 30kW
- 138kWh / 60kW
- 207kWh / 90kW
- 276kWh / 120kW
- 345kWh / 150kW
- 414kWh / 180kW

Using only one energy management system (EMS-C) to control the system ensures a straight forwards installation. The EMS is fitted inside one of the CAIO cabinets and a simple data cable link is all that is required to the other cabinets.

A 3 phase meter is used to measure the grid supply coupled with appropriate sized CT clamps, up to an additional 2x meters can be used to monitor site generation.

SINGLE LINE DIAGRAM EXAMPLE

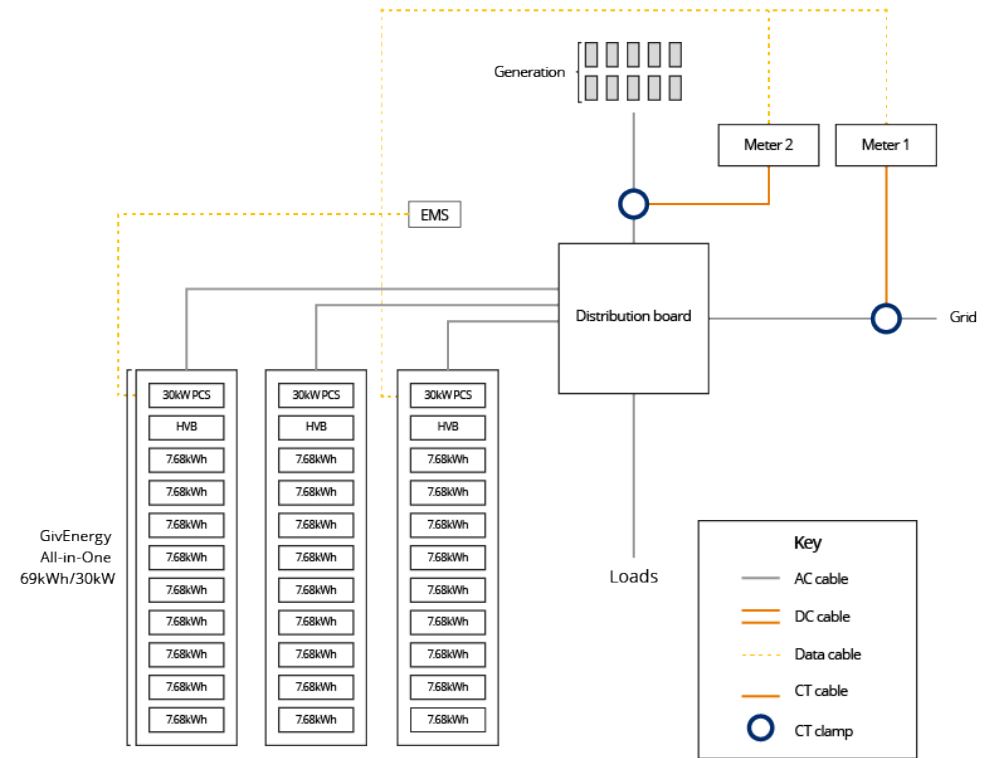

*3 cabinets shown, up to 6 cabinets can be connected together in the same way.

AC parameters (inverter)

Rated power	30kW
Maximum power	36kW
Rated current	44A
Rated grid voltage	400v
Grid voltage range	300-400v
Rated grid frequency	50/60Hz
Current total harmonic distortion rate	<3% (at rated power)
Power factor	>0.99
Power factor range	-1 to 1
Maximum efficiency	98.8%
Connectivity	Fast fit connector (top mounted)
Electrical topology	Transformer-less
Warranty	10 years

DC parameters (battery)

Configuration	1 x High voltage box 9 x 7.68kWh batteries (100Ah) packs
Cell chemistry	LiFePO ₄
Voltage range	600 – 790VDC
Depth of discharge	90%
Operating temperature	-10 to +55°C (derating below 0 and above 45°C)
Connections	Busbar connection on rear
Safety	Robust multipoint monitoring BMS
Warranty	10 years*

*70% remaining capacity after the first of 10 years or 10MWh per kWh throughput.

Dimensions	2050H x 600W x 800D (mm)
Weight	950kg +/-2%
Cooling	Intelligent air cooling
Environmental temperature	-40 to +60°C
Maximum altitude	4000m (derating above 3000m)
Standby power consumption	<10W
SKU	GIV-SME-30/69-ID
Protection class	IP20
Certification	G99
User interface	Emergency stop, Operation & fault lights
Connectivity	LAN / WiFi / Modbus / CANbus
Expansion	1 – 6 units to work in parallel

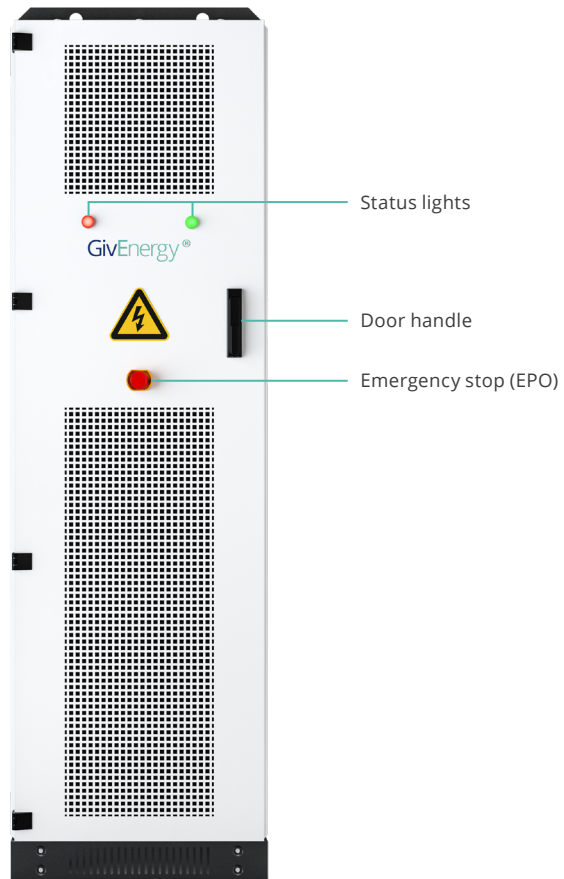

Installation Diagram of Main Components Inside the SME Cabinet

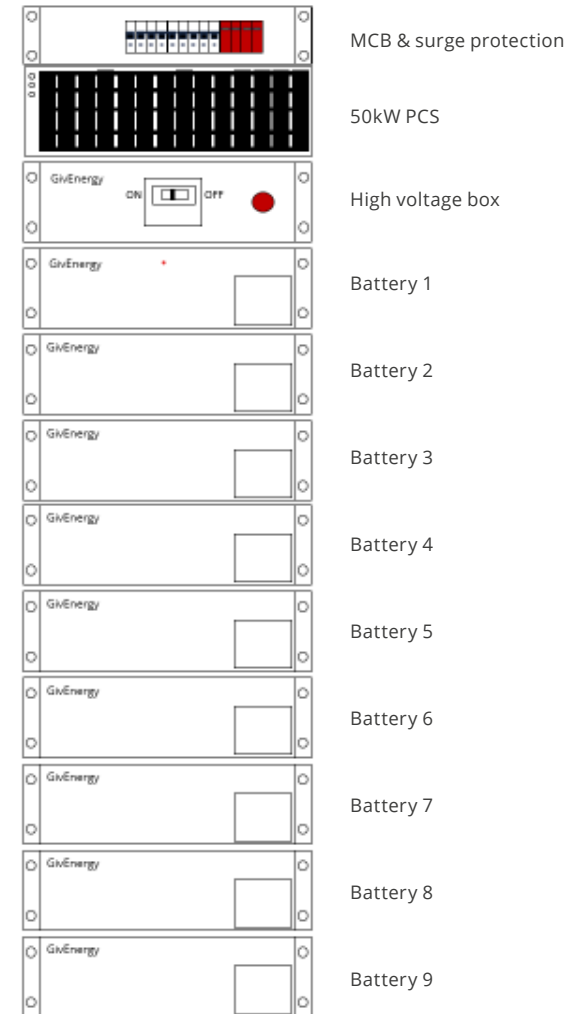

The CAIO and battery packs are delivered on 2 separate pallets.

The CAIO will be delivered palletised in a cardboard box;

1. Remove all packaging and foam protection
2. Remove the lower black trim on all sides of the battery cabinet – Be careful not to lose any of the bolts
3. Unbolt the cabinet from its pallet on all 4 corners
4. Lift the cabinet to allow removal of the pallet being careful not to put any body part in a potential trap area/drop zone
5. The cabinet can now be positioned using the lifting equipment such as a standard pallet or forklift truck
6. The key to the door is attached to the handle

The battery packs and high voltage box are delivered on one pallet;

1. Remove all outer packaging
2. Carefully lower the battery boxes one at a time, using a lifting aid if required
3. Unbox batteries one at a time, taking care not to drop them or stand them on their connection blocks
4. Remove all foam and plastic protection
5. Install each battery as it is unboxed to prevent accidental damage
6. Battery packs and the high voltage box must be installed in the correct order, see previous page for details



The battery packs have an electrical connector block on their rear, do not stand the batteries up on this as this could damage this connector.

Component	CAIO cabinet	Battery pack (7.6kWh)	HV box
Size (WxDxH)	600 x 800 x 2050	452 x 665 x 134	452 x 664 x 134
Weight (kg)	250	76	40

Forklift Transportation

1. During transportation, ensure the box's centre of gravity is positioned between the forklift's two forks
2. Avoid long-distance transportation or traveling on sloped roads with the forklift
3. Handle with care during lifting and lowering to avoid impact or vibration
4. Due to the large size of the CAIO, it may obstruct the operator's view. Arrange for an assistant if necessary

Unpacking checklist

Inspection items	Checklist
No damage, scratches, dents, etc. in appearance	
The product items ordered are complete.	
The nameplate information is the same as the ordered product model.	
Warning labels are not damaged, scratched, blurred, etc.	

To ensure optimal operation and lifetime of the system it must be installed in an environment that meets the following criteria at a minimum;

- ✔ 0°C to 40°C ambient temperature
- ✔ 0 to 95% non-condensing humidity
- ✔ <5000m altitude
- ✔ In an area with adequate ventilation

The CAIO cabinet must only be installed internally on level flat ground, it is possible to secure it to the floor on each corner if required.

Full power operation is available between 10°C to 45°C internal temperature. Reduced power operation outside of the temperature range, please see Temperature and SOC derating guide.

Storage whilst not in use.

The units must be stored in their original packaging at temperatures between 0°C - 50°C for a maximum of 6 months without power cycling the system.

Ventilation

The CAIO must have a suitable airflow to ensure optimal operation. Ambient air temperature is recommended to be less than 30°C. In extreme hot and cold environments forced cooling and heating may be required.

To allow optimal ventilation at least 100mm should be left between the CAIO and a back wall.

Access

It is recommended that access to the area the system is located within is restricted. A locked door prevents immediate access to the general public however the emergency stop button is accessible on the front door.

For installation and maintenance a space of one meter is recommended to allow suitable access.

Assembly and connections

Power is connected on the top of the CAIO cabinet, remove the plug out of the socket and use suitable cable to wire the CAIO to a electrical supply, details of ratings in the below table.

Tip: Using flexible cable like HO7 will make this easier, if the CAIO is not located adjacent to the sites electrical supply it is recommended that an isolator is installed next to the CAIO.

Data and communication cables should be fed through the cable entry gland at the top of the CAIO cabinet. The cable entry cover in front of the MCB and surge protection is removed using the 4 bolts to reveal data connections.

Note: Ensure that all grommets are located correctly to avoid sharp metal edges damaging the cables.

When installing the high voltage box & 9x battery into the cabinet please use correct lifting method to avoid injury. Slide the battery packs into rack pushing carefully but firmly back to ensure the power and data connection align, once all the way back install the 4 bolts to ensure the battery does not move.

Before turning on the internal MCB's within the CAIO AC voltage, polarity and phase rotation must be checked, this can be achieved on the top of the internal MCB's with the MCB's off.

AC supply characteristics

PCS size	30kW
Max AC current (A)	44A
Recommend protective device (A)	50A
Cable size (mm ²)	10*

**Cable size must always confirmed with BS7671 wiring regulations and a larger cable may be required, in certain circumstances it may also be possible to use a smaller cable.*

AC Input and Communication Port Locations

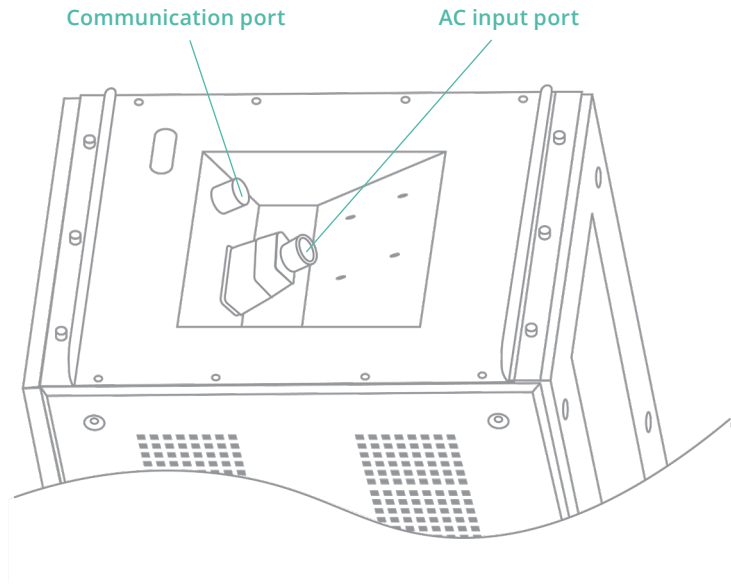

AC Plug Connector Terminal Definition

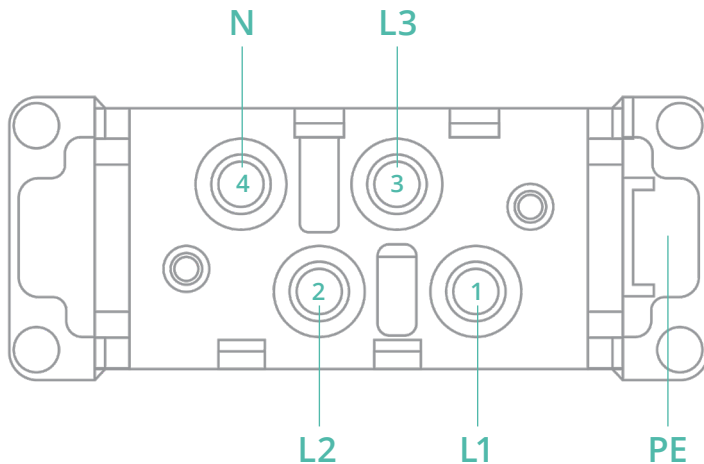

Each system or group of CAIO's will require one EMS-C for control.

The EMS-C is fitted to one cabinet only within a system, all cabinets are delivered exactly the same with connections available for the EMS-C pre-installed. Simply hook the EMS-C onto the fixing points provided on the inside of the door and use the nut provided in the EMS box to lock it into place.

The wiring loom on the door contains 1x power, 1x earth, and 2x data connections, simply un-roll the cable tape and pull the pre-wired harness out, plugging in as per the diagram below.

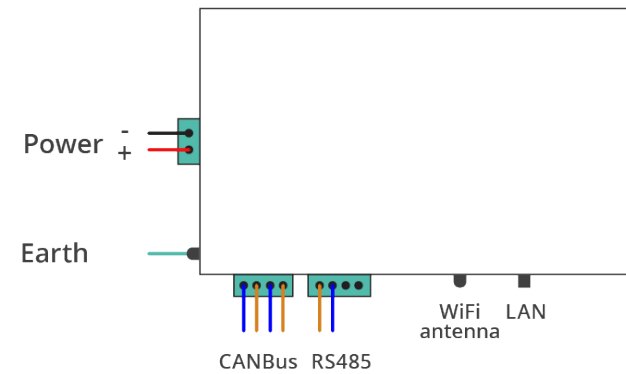

EMS-C positioning example

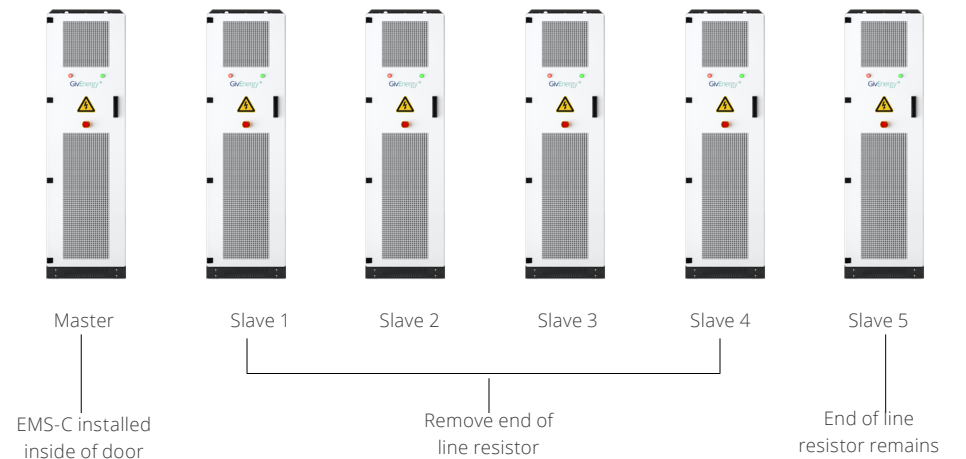

EMS-C full connection overview

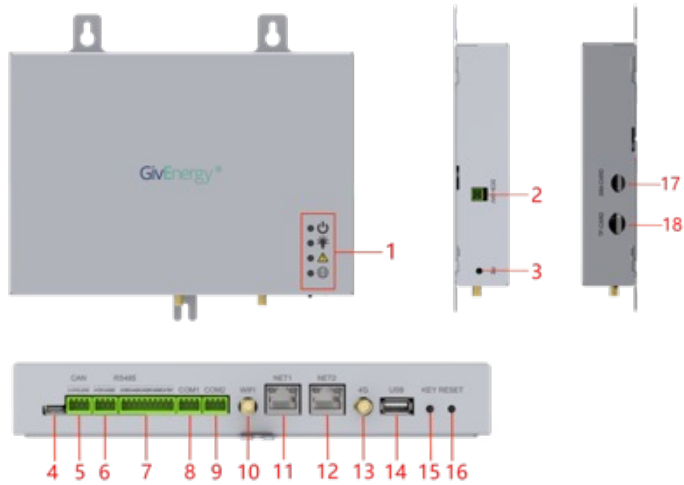

- | | |
|----------------------------------|-----------------------------|
| 1 — Operation LED's | 10 — WiFi antenna connector |
| 2 — 24v Power input | 11 — LAN 1 |
| 3 — Earthing point | 12 — LAN 2 |
| 4 — USB C | 13 — Not currently used |
| 5 — CAN communication (1 & 2) | 14 — USB |
| 6 — RS485 communication (1 & 2) | 15 — 'Key' button |
| 7 — RS485 communication (3 to 8) | 16 — Reset button |
| 8 — Not currently used | 17 — Not currently used |
| 9 — Not currently used | 18 — Not currently used |

When fitting multiple CAIO's together two data connection cables are required between cabinets. The data connections can be found behind top cable entry cover. It is recommended to use Belden type shielded cable for this.

The below example demonstrates how this wired for three CAIOs, the principle is the same for more or less units.

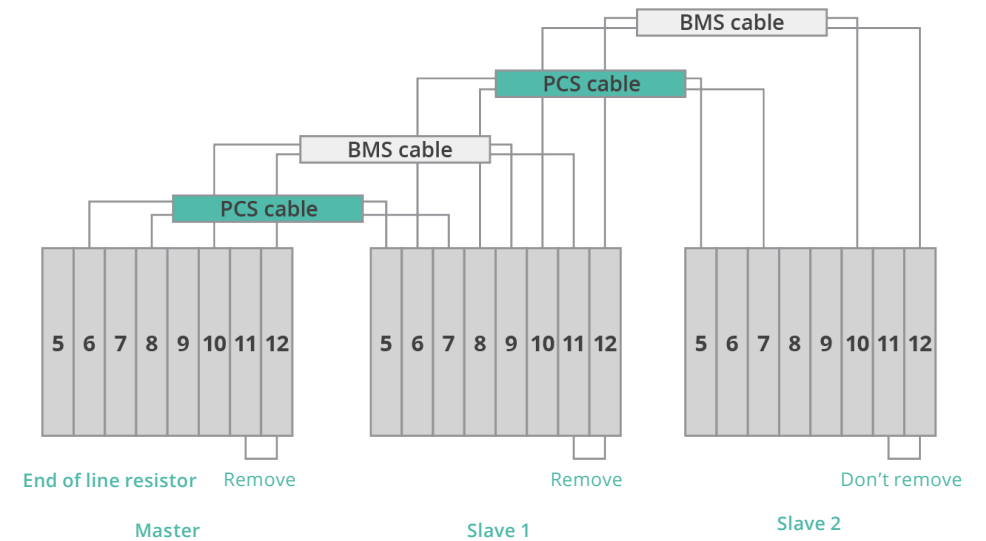

Please note: only terminals used for interconnection of multiple CAIOs show.

End of line resistors

Every CAIO cabinet has an end of line resistor installed in the BMS terminal block only the last CAIO in a chain should have the end of line resistor installed - please remove out of all of the cabinets (refer to the diagram above)

DATA CONNECTIONS SINGLE CAIO

When fitting just one CAIO the meter data cable is connected to terminals 13 and 14 as per the below diagram. It is recommended to use Belden type shielded cable for this.

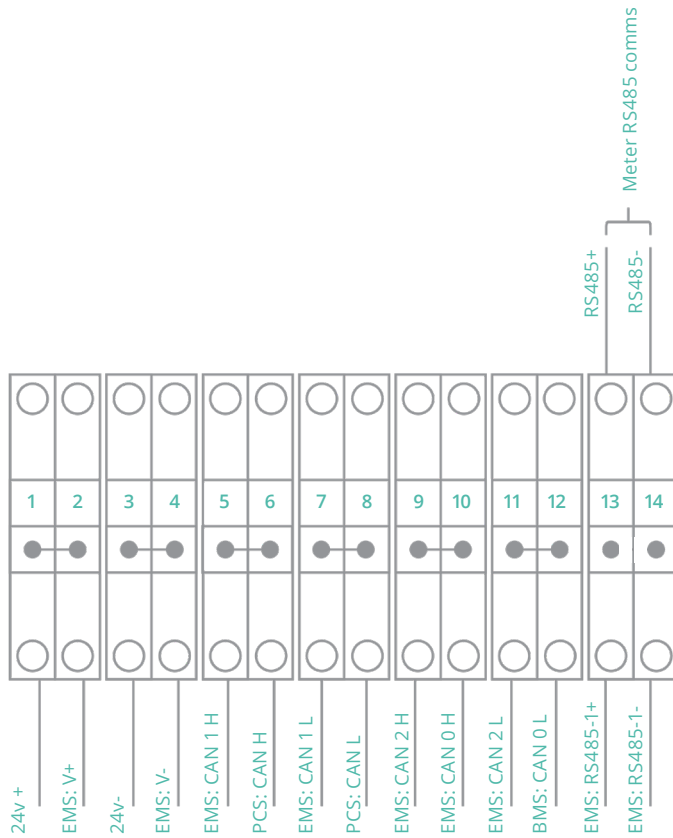

Internet connectivity can be by WiFi or LAN if using LAN this is connected directly into the EMS mounted on the door.

PARALLEL COMMERCIAL ALL IN ONES

When fitting multiple CAIOs the meter data cable is connected to terminals 13 and 14 in the master cabinet only as per the below diagram. It is recommended to use Belden type shielded cable for this.

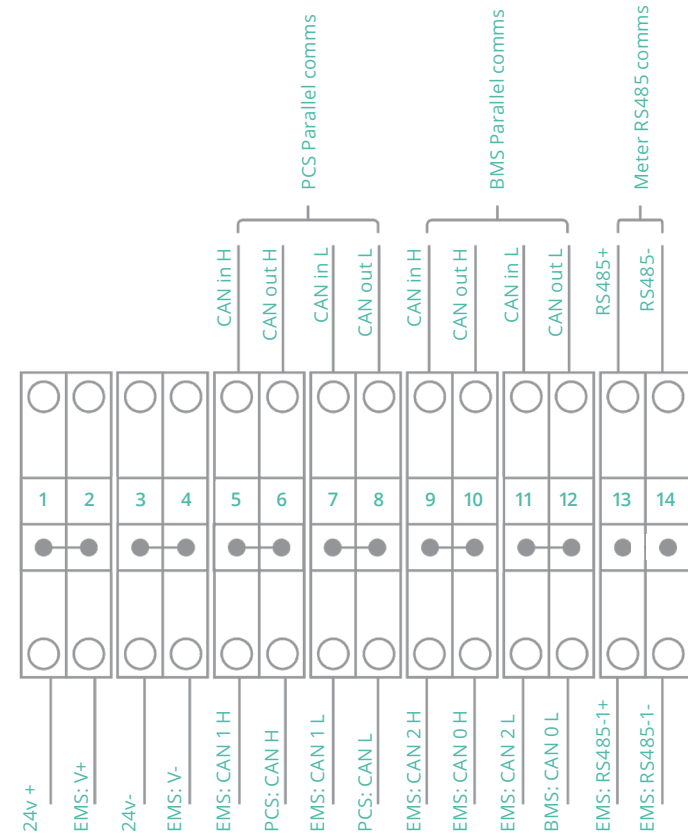

Internet connectivity can be by WiFi or LAN if using LAN this is connected directly into the EMS mounted on the door.

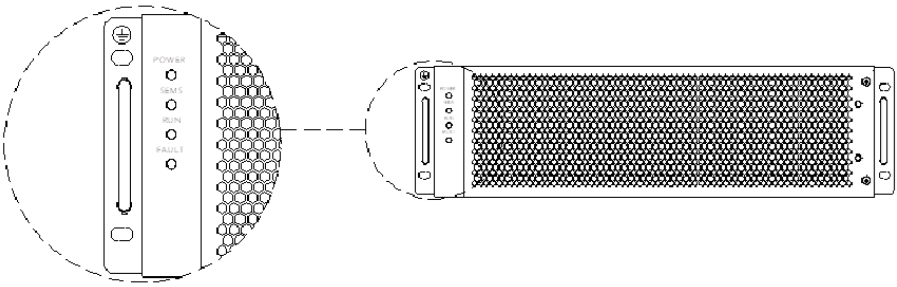

Indicator	Status	Description
POWER (green)	Steady on	Both battery and grid are connected
	Fast flash*	Battery not connected
	Slow flash**	Grid not connected
SEMS (green)	Steady off	Both battery and grid are connected
	Fast flash	Normal communication
	Steady off	Communication abnormalities
RUN (green)	Steady on	PCS is down
	Fast flash	PCS is in standby mode
	Slow flash	PCS is in charging state
FAULT (red)	Steady on	PCS is in a discharged state
	Fast flash	Alarm
	Slow flash	Fault, shutdown status

Before the commissioning run thoroughly inspect the installation of the equipment. Pay special attention to ensure that the AC voltage meet the inverter’s requirements and verify that the polarity and phase sequence are correct.

Check that all connections comply with relevant standards and regulations. Ensure that the system is properly grounded. Ground resistance is crucial for the safety of the entire system and must be verified to meet the requirements before the initial commissioning run.

Commissioning Run

When performing the initial start-up of the energy storage equipment, strictly follow the steps outlined below:

1. After confirming the suitability of AC supply press the power button on the high voltage box in the master cabinet
2. Once the EMS has started follow the steps in the EMS instruction manual to configure the system
3. Once the EMS is configured turn on all high voltage boxes with both the power button and MCB
4. Turn on the AC and surge protection MCBs at the top of the cabinet
5. Complete commissioning checks as per the EMS instruction manual

Power on procedure

The below instructions are only to be used after a system has been commissioned by the installation engineer.

1. Ensure all emergency stop buttons are released
2. Press the power on button on the high voltage box within the master cabinet
3. Wait for the EMS to start up (solid green power light)
4. Turn on the MCB built in to the high voltage box and repeat for all other CAIOs on site
5. Turn on AC and surge protection MCBs in all cabinets
6. Confirm desired system operation via the local control interface or the online portal

Shutdown procedure

In an emergency press the emergency stop button on all CAIOs first, then follow the below instructions.

Under normal operating conditions follow the below steps.

1. Turn off the system using the local control interface or online portal
2. Turn off AC and surge protection and MCBs in all cabinets
3. Turn off the MCB built in to the high voltage box in all cabinets
4. Turn off the power button on the high voltage box in all cabinets

Initial testing/commissioning

The CAIO must be commissioned by a trained installer to ensure system safety and correct operation. Once the installation is completed, programmed, and powered up correct system communication should be confirmed.

It is recommended that a system is ran at full power ion both charge and discharge states for a period of 10 minutes, during this process all meter communication can be confirmed.

For more details of how to set and adjust operating parameters please refer to the EMS-C user manual.

Maintenance

Ensure that the ventilation holes on the front and back of the CAIO do not become obstructed or blocked with dust.

Support

Free remote support is included with all systems for the period of the warranty.

Phone: 01377 252 874

Email: commercial@givenergy.co.uk

GivEnergy Commercial Ltd

Osprey House
Brymbo Road
Stoke-on-Trent
ST5 9HX

01377 252 874

www.givenergy.co.uk

