



Installation / User Manual

APsystems YC500I

Photovoltaic Grid-connected Microinverter

Rev 1.0

ALTENERGY POWER SYSTEM Inc.
www.APsystems.com

APsystems Europe
Cypresbaan 7, 2908LT, Capelle aan den IJssel, The Netherlands
TEL: 0031-10-2582670 EMAIL: info@altenergy-power.com

© *All Rights Reserved*

(For Europe/Great Britain/France/Germany)

Table of Contents

Important Safety Instructions	2
Safety Instructions	2
Radio Interference Statement.....	3
Symbols replace words on the equipment, on a display, or in manuals.....	4
APsystems Microinverter System Introduction	5
APsystems Microinverter YC500I Introduction	7
APsystems Microinverter System Installation	8
Additional Installation components from APsystems	8
Required Parts and Tools from you	8
Installation Procedures	9
Step 1 - Position the AC bus cable	9
Step 2 - Install the AC branch circuit junction box	9
Step 3 - Attach the APsystems Microinverters to the racking or the PV module frame	9
Step 4 - Connect the APsystems microinverter to AC bus cable.....	10
Step 5 - Install a AC bus protective end cap at the end of AC bus cable.....	11
Step 6 - Connect APsystems Microinverters to the PV Modules	11
Step 7 - Complete the APsystems installation map	12
Step 8 - Place a Warning Notice.....	13
APsystems microinverter system operating instructions	14
Troubleshooting	15
Status Indications and Error Reporting	15
Start up LED	15
Operation LED.....	15
GFDI Error	15
Other Faults	15
Troubleshooting a non-operating APsystems Microinverter	16
Maintenance	16
Replace a microinverter	17
Technical Data	18
APsystems YC500I Microinverter Datasheet.....	19
Wiring Diagram	20
Sample Wiring Diagram - Single Phase	20
Sample Wiring Diagram - Three Phase	21

Important Safety Instructions

This manual contains important instructions to follow during installation and maintenance of the APsystems Photovoltaic Grid-connected Inverter (Microinverter). To reduce the risk of electrical shock and ensure the safe installation and operation of the APsystems Microinverter, the following symbols appear throughout this document to indicate dangerous conditions and important safety instructions.

Specifications subject to change without notice - please ensure you are using the most recent update found at www.APsystems.com

WARNING: This indicates a situation where failure to follow instructions may cause a serious hardware failure or personnel danger if not applied appropriately. Use extreme caution when performing this task.



WARNING
SYMBOL

NOTE: This indicates information that is important for optimized microinverter operation. Follow these instructions closely.



NOTE
SYMBOL

Safety Instructions

- ✓ **Do NOT** disconnect the PV module from the APsystems Microinverter without first disconnecting the AC power.
- ✓ Only qualified professionals should install and/or replace APsystems Microinverters.
- ✓ Perform all electrical installations in accordance with local electrical codes.
- ✓ Before installing or using the APsystems Microinverter, please read all instructions and cautionary markings in the technical documents and on the APsystems Microinverter system and the solar-array.
- ✓ Be aware that the body of the APsystems Microinverter is the heat sink and can reach a temperature of 80°C. To reduce risk of burns, do not touch the body of the Microinverter.
- ✓ **Do NOT** attempt to repair the APsystems Microinverter. If it fails, contact APsystems Customer Support to obtain an RMA number and start the replacement process. Damaging or opening the APsystems Microinverter will void the warranty.
- ✓ **Caution!**
The external protective earthing conductor is connected to the inverter protective earthing terminal through AC connector.
When connecting, connect the AC connector first to ensure the inverter earthing then do the DC connections.
When disconnecting, disconnect the AC by opening the branch circuit breaker first but maintain the protective earthing conductor in the branch circuit breaker connect to the inverter ,then disconnect the DC inputs.
- ✓ In any circumstance, do not connect DC input when AC connector is unplugged.
- ✓ Please install isolation switching devices on the AC side of the inverter.

Important Safety Instructions

Radio Interference Statement

CE EMC Compliance: The equipment can comply with CE EMC, which are designed to protect against harmful interference in a residential installation. The equipment could radiate radio frequency energy and this might cause harmful interference to radio communications if not following the instructions when installing and using the equipment. But there is no guarantee that interference will not occur in a particular installation. If this equipment causes harmful interference to radio or television reception, the following measures might resolve the issues:







- A) Relocate the receiving antenna and keep it well away from the equipment.

- B) Consult the dealer or an experienced radio / TV technical for help.

Changes or modifications not expressly approved by the party responsible for compliance may void the user's authority to operate the equipment.

Important Safety Instructions

Symbols replace words on the equipment, on a display, or in manuals

 APsystems ALTENERGY POWER	Trademark
	Caution, risk of electric shock
	Caution, hot surface
	Symbol for the marking of electrical and electronics devices according to Directive 2002/96/EC. Indicates that the device, accessories and the packaging must not be disposed as unsorted municipal waste and must be collected separately at the end of the usage. Please follow Local Ordinances or Regulations for disposal or contact an authorized representative of the manufacturer for information concerning the decommissioning of equipment.
	CE mark is attached to the solar inverter to verify that the unit follows the provisions of the European Low Voltage and EMC Directives
	Refer to the operating instructions
Qualified personnel	Person adequately advised or supervised by an electrically skilled person to enable him or her to perceive risks and to avoid hazards which electricity can create. For the purpose of the safety information of this manual, a "qualified person" is someone who is familiar with requirements for safety, refrigeration system and EMC and is authorized to energize, ground, and tag equipment, systems, and circuits in accordance with established safety procedures. The inverter and endues system may only be commissioned and operated by qualified personnel.

APsystems Microinverter System Introduction

The APsystems Microinverter is used in utility-interactive grid-tied applications, comprised of three key elements:

- APsystems Microinverter
- APsystems Energy Communication Unit (ECU)
- APsystems Energy Monitor and Analysis (EMA) web-based monitoring and analysis system

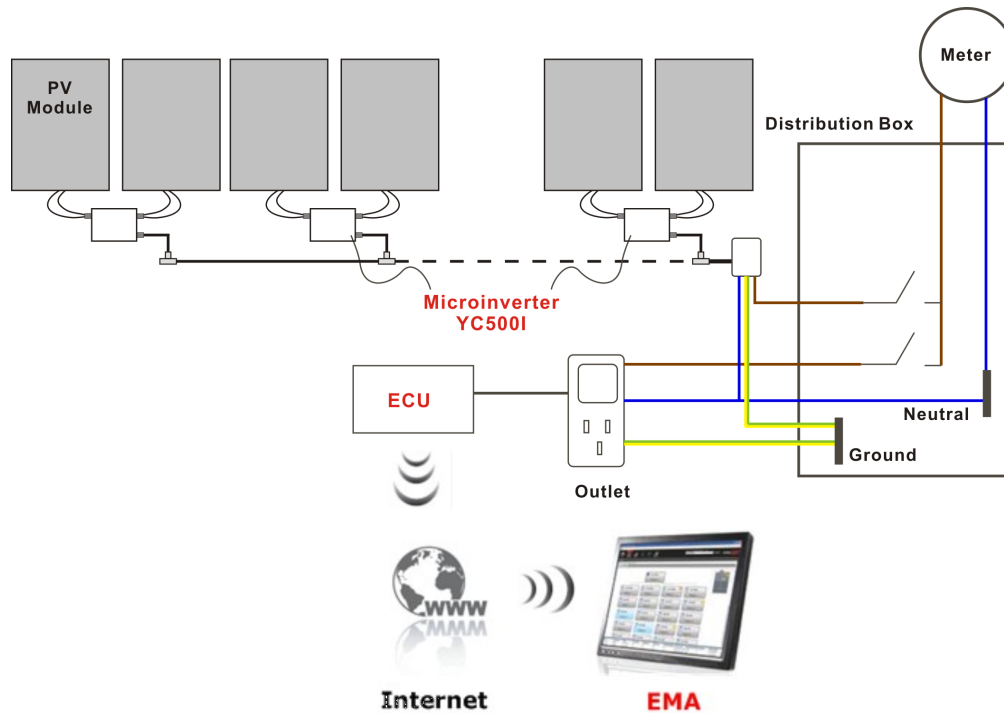

Figure 1

NOTE: Two switching devices connected in series do not be incorporated within the inverter, external isolation switching Devices which meets the VDE4105(VDE0126-1-1/A1) or VDE 0126 standard shall be provided. For example can be BISI 4.0 from changetec or G4PF33-1 from



TELE.

APsystems Microinverter System Introduction

This integrated system improves safety; maximizes solar energy harvest; increases system reliability, and simplifies solar system design, installation, maintenance, and management.

APsystems Microinverters maximize PV energy production

Each PV module has individual Maximum Peak Power Tracking (MPPT) controls, which ensures that the maximum power is exported to the utility grid regardless of the performance of the other PV modules in the array. When PV modules in the array are affected by shade, dust, orientation, or any situation in which one module underperforms compared with the other units, the APsystems Microinverter ensures top performance from the array by maximizing the performance of each module within the array.

More reliable than centralized or string inverters

The distributed APsystems Microinverter system ensures that no single point of system failure exists across the PV system. APsystems Microinverters are designed to operate at full power at ambient outdoor temperatures of up to 149°F (65°C). The inverter housing is designed for outdoor installation and complies with the IP65 environmental enclosure rating.

Simple to install

You can install individual PV modules in any combination of module quantity, orientation, type, and power rate. **The Ground wire (PE) of the AC cable is connected to the chassis inside of the Microinverter, eliminating the installation of grounding wire.**

Smart system performance monitoring and analysis

The APsystems Energy Communication Unit (ECU) is installed by simply plugging it into any wall outlet and providing an Ethernet or Wi-Fi connection to broadband router or modem. After installing the ECU, the full network of APsystems Microinverters automatically reports to the APsystems Energy Monitor and analysis (EMA) web server. The EMA software displays performance trends, informs you of abnormal events, and controls system shutdown when it is needed. (See ECU manual for instructions.)

APsystems Microinverter YC500I Introduction

The APsystems YC500I Microinverters connect with the single-phase grid, and can also use multiple APsystems Microinverters in the form of single-phase grid to achieve three-phase grid, and operate with most 60 and 72 cell PV modules. For more information, please see the Technical Data page (p.18) of this manual, or sign in APsystems website to obtain a solar panel list which can match with APsystems Microinverters:

www.APsystems.com

Model Number	AC grid	PV Module	Max. # Per branch	Module Connector
YC500I	50Hz/230V	60,72 Cell	7 for 20A breaker	MC-4 Type or Customize

APsystems Microinverter System Installation

A PV system using Apsystems Microinverters is simple to install. Each Microinverter easily mounts on the PV racking, directly beneath the PV module(s). Low voltage DC wires connect from the PV module directly to the Microinverter, eliminating the risk of high DC voltage. Installation **MUST** comply with local regulations and technical rules.

Special Statement! *An AC GFCI device **should not** be used to protect the dedicated circuit to the Apsystems microinverter even though it is an outside circuit. None of the small GFCI devices (5mA-30 mA) are designed for back feeding and will be damaged if back feed. In a similar manner, AC AFCIs have not been evaluated for back feeding and may be damaged if back feed with the output of a PV inverter.*

WARNING: Perform all electrical installations in accordance with localelectrical codes.

WARNING: Be aware that only qualified professionals should install and/or replace Apsystems Microinverters.

WARNING: Before installing or using an Apsystems Microinverter, please read all instructions and warnings in the technical documents and on the Apsystems Microinverter system itself as well as on the PV array.

WARNING: Be aware that installation of this equipment includes the risk of electric shock.

WARNING: Do not touch any live parts in the system, including the PV array, when the system has been connected to the electrical grid.

NOTE: Strongly recommend to install Surge protection Devices in the dedicated meter box.



Additional Installation components from Apsystems

- AC bus protective end cap (sold separately)
- Sealing caps (sold separately)

Required Parts and Tools from you

In addition to your PV array and its associated hardware, you will need the following items:

- An AC connection junction box
- Mounting hardware suitable for module racking
- Sockets and wrenches for mounting hardware
- Continuous grounding conductor and grounding washers
- A Phillips screwdriver
- A torque wrench

Installation Procedures

Step 1 - Position the AC bus cable

Step 2 - Install the AC branch circuit junction box

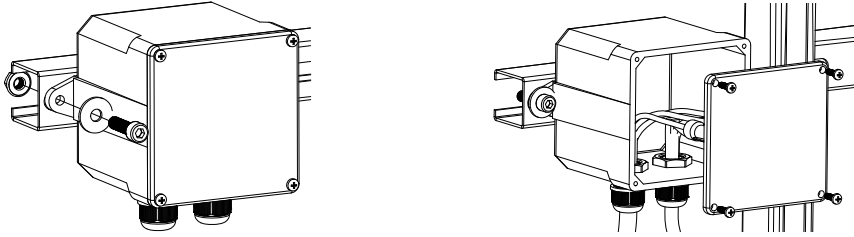

Figure 2

- Install an appropriate junction box at a suitable location on the PV racking system ((typically at the end of a branch of modules).
- Connect the open wire end of the AC bus cable into the junction box using an appropriate gland or strain relief fitting.
- Wire the conductors: L - BROWN; N - BLUE; PE - YELLOW GREEN.
- Connect the AC branch circuit junction box to the point of utility interconnection.

Step 3 - Attach the APsystems Microinverters to the racking or the PV module frame

- Mark the location of the Microinverter on the rack, with respect to the PV module junction box or any other obstructions.
- Mount one Microinverter at each of these locations using hardware recommended by your module racking vendor.

Option 1:

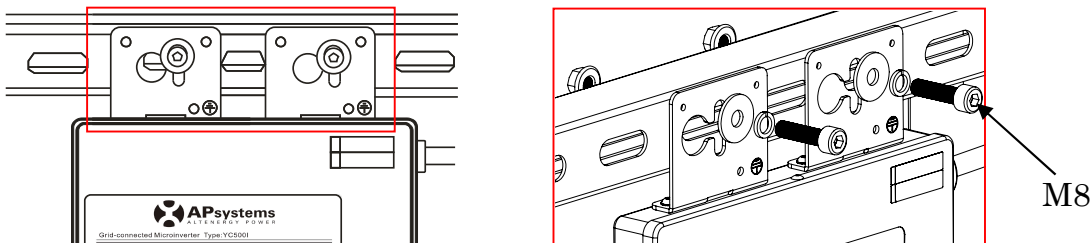

Figure 3

Option 2:

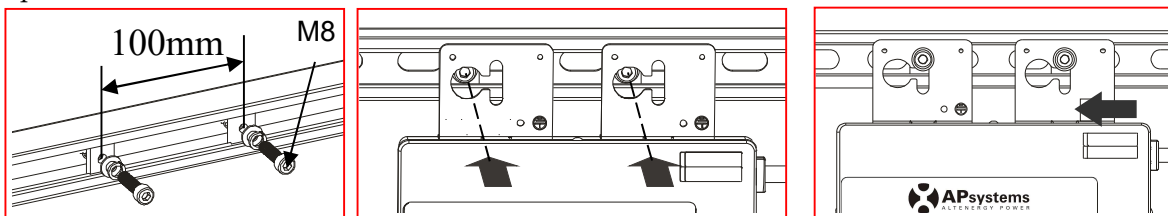

Figure 4

WARNING: Prior to installing any of the microinverters, verify that the utility voltage at the point of common connection matches the voltage rating on microinverter label.



WARNING: Do not mount the Microinverter in a location that allows exposure to direct sunlight. Allow a minimum of 3/4" (1.5cm.) between the roof and the bottom of the Microinverter to allow proper air flow.



Installation Procedures

Step 4 - Connect the APsystems microinverter to AC bus cable

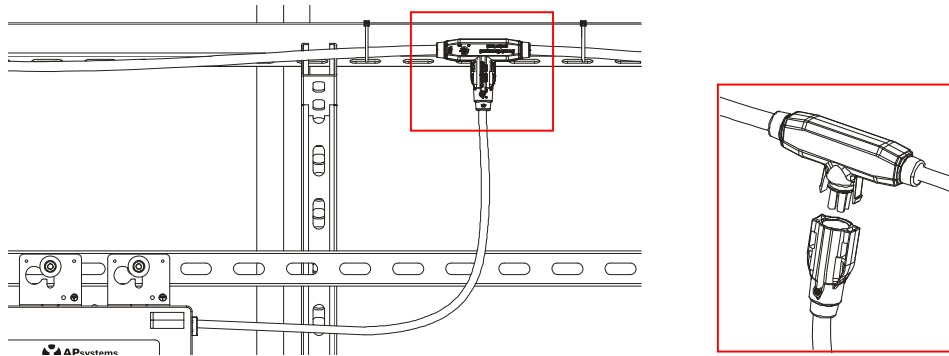
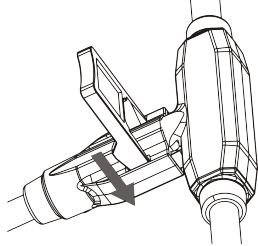

Figure 5

Best Practice: Use the Withdrawal Tool of AC Bus to split the connectors.



- Check the Microinverter technical data page (p.24) for the maximum allowable number of Microinverters on each AC branch circuit.
- Plug the AC connector of the Microinverter into the AC bus
- Install a AC bus protective end cap on the open AC connector of the last Microinverter in the AC branch circuit.

AC connector interface as follows.

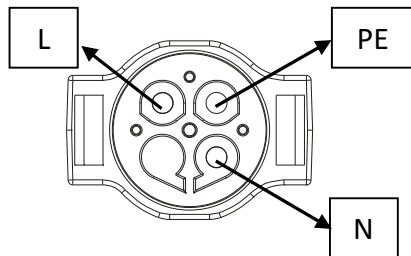

Figure 6

Cover any unused connectors with sealing caps to protect the connectors.

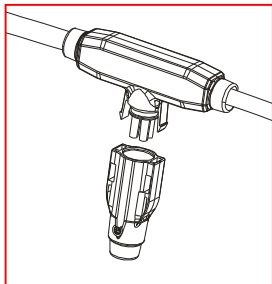

Figure 7

WARNING: Do NOT exceed maximum number of Microinverters in an AC branch circuit, as displayed on the Technical Data page (p.18) of this manual.



Installation Procedures

Step 5 - Install a AC bus protective end cap at the end of AC bus cable

- a. Strip cable jacket.

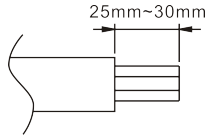

- b. Insert the cable end into the seal.

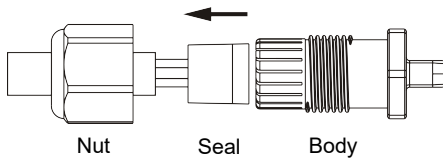

- c. Insert the wires into the cable clamps.

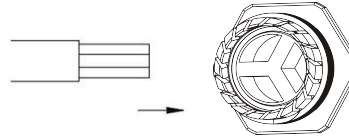

- d. Rotate the nut with 3.3N·m until the latching mechanism meets the base.

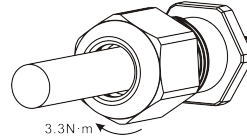

Figure 8

Step 6 - Connect APsystems Microinverters to the PV Modules

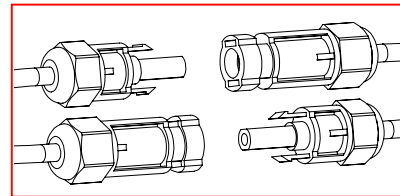
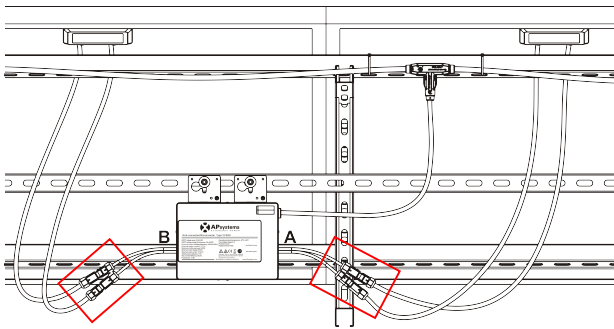

Figure 9

The inverter YC250's DC input positive pole connect to earthed enclosure inside the enclosure.

The inverter YC500's DC input negative pole connect to earthed enclosure inside the enclosure.

NOTE: When plugging in the DC cables, the Microinverter should immediately blink green three times. This will happen as soon as the cables are plugged in and will show that the Microinverter is functioning correctly. This entire check function will start and end within 5 seconds of plugging in the unit, so pay careful attention to these lights when connecting the DC cables.



WARNING: Double check to make sure all of the AC and DC wiring has been correctly installed. Ensure that none of the AC and/or DC wires are pinched or damaged. Make sure that all of the junction boxes are properly closed.



NOTE: About A and B Sides corresponding the location of modules, EMA registration show acquiesce in this installation. If there are different connection methods, please email the detail installation drawings to us to register, or the A, B Sides corresponding component location will not correspond to the EMA position.



Installation Procedures

Step 7 - Complete the APsystems installation map

Fill in the APsystems Registration Cards, which provide system information and the installation map. Feel free to provide your own layout if a larger or more intricate installation map is required. The layout map provided is designed to accommodate labels in vertical or horizontal orientation to meet all the field PV connections.

- Each APsystems Microinverter has removable serial number labels. Peel labels off, affix one to the respective location on the APsystems installation map, and fill in A,B in the label below (as figure12) according to the layout on the roof (as figure 11). Then affix another label to the PV module frame which is easy to see. The warranty cards can obtain from the appendix of this manual or APsystems website www.APsystems.com
- Fill the warranty cards and email to APsystems at emasupport@altenergy-power.com
- APsystems will create the EMA account and email you the account information. Then you can use the EMA website to view detailed performance of your PV system. You can learn more information on energy monitoring and analysis system from APsystems website www.APsystems.com

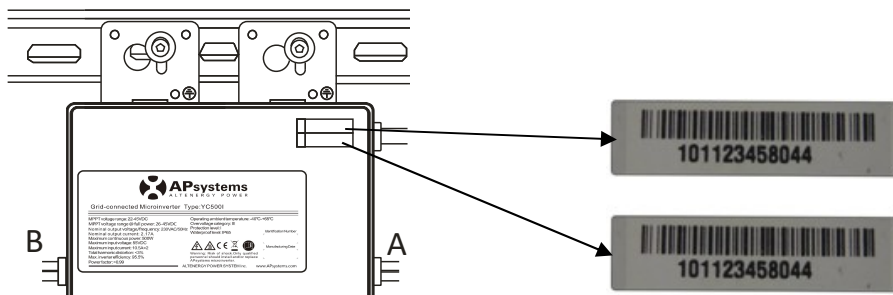

Figure 10

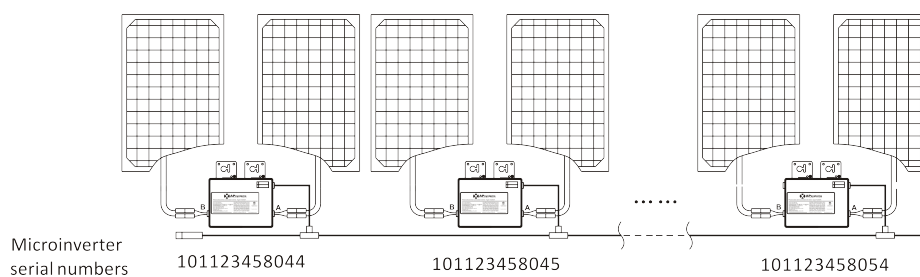



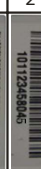

Figure 11

Installation Procedures

APsystems Microinverter&Energy Communication Unit Warranty Card

The APsystems Installation Map is a diagram of the physical location of each microinverter in your PV installation. Each APsystems microinverter has a removable serial number label located on the mounting plate. Peel the label and affix it to the respective location on the APsystems installation map.

Installation Map Template

1	2	3	4	5	6	7	8	9	10	11	12	13	14	15	16	17	18	19	20	21	22	
																						
B	A	B	A							B	A											

To register your APsystems microinverter, please mail this warranty registration card to: emasupport@altenergy-power.com

Figure 12

- NOTE:**
1. The layout of the inverters' serial numbers on the warranty card is only suitable for general arrangement.
 2. Step 1~7 can be done in any order..
 3. Warranty card is located in Appendix last page of this manual.
 4. You can use Scanning Gun or mobile phone to scan the serial numbers on the map when set ECU (see ECU manual).



Step 8 - Place a Warning Notice

A warning notice shall be placed in such a position that any person gaining access to live parts will be warned in advance of the need to isolate those live parts from all points of supply. Special attention should be paid that the power supply, measuring circuits (sense lines) and other parts may not be isolated from the network when the switch of the interface protection is open.

As a minimum, warning labels shall be placed:

- On the switchboard (DNO panel and consumer unit) that has the micro-generator connected to it;
- On all switchboards in between the consumer unit and the micro-generator itself;
- On, or in the micro-generator itself;
- At all points of isolation for the micro-generator.

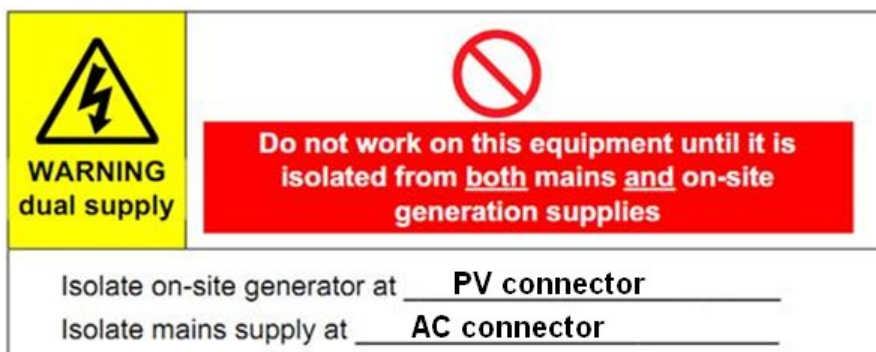

Figure 13

To operate the APsystems microinverter PV system:

1. Turn ON the AC circuit breaker on each microinverter AC branch circuit.
2. Turn ON the main utility-grid AC circuit breaker. Your system will start producing power after a two-minute waiting time.
3. The units should start blinking green every 2 seconds five minutes after turning on the AC circuit breaker. This means they are producing power normally, but have not yet connected to the ECU. After the ECU has been plugged in and acknowledges the Microinverters, they will start to blink green every 10 seconds.
4. Plug in the ECU and follow the instructions according to the manual for the ECU.
5. The APsystems Microinverters will start to send performance data over power line to the ECU. The time required for all the Microinverters in the system to report to the ECU will vary with the number of Microinverters in the system. You can verify proper operation of the APsystems Microinverters via the ECU. See the ECU Installation and Operation Manual for more information.

NOTE: Once AC power is applied, about 0.1A current and 25VA(W) power for each microinverter may be measured with a meter. This Current and Power are Reactive. The inverters ARE NOT operating. After an over 60s waiting time, the inverters will start operation.



Troubleshooting

Qualified personnel can use the following troubleshooting steps if the PV system does not operate correctly:

Status Indications and Error Reporting

Start up LED

One quick red light followed by three short green blinks when DC power is first applied to the Microinverter indicates a successful Microinverter startup.

Operation LED

Flashing Slow Green (10 sec. gap) - Producing power and communicating with ECU

Flashing Fast Green (2 sec. gap) - Producing power and not communicating with ECU over 60mins

Flashing Red - Not producing power

Steady Red - Electrode assembly ground fault protection

GFDI Error

A solid red LED indicates the Microinverter has detected a Ground Fault Detector Interrupter (GFDI) error in the PV system. Unless the GFDI error has been cleared, the LED will remain red and the ECU will keep reporting the fault.

After the ground fault error is fixed, follow the instructions in the ECU Installation and Operation Manual to clear this GFDI error reporting.

Other Faults

All other faults are reported to the ECU. Refer to the ECU Installation and Operation Manual for a list of additional faults and troubleshooting procedures.

WARNING: Only qualified personnel should directly handle the APsystems microinverter.



WARNING: Never disconnect the DC wire connectors under load. Ensure that no current is flowing in the DC wires prior to disconnecting. An opaque covering may be used to cover the module prior to disconnecting the module.



WARNING: Always disconnect AC power before disconnecting the PV module wires from the APsystems microinverter. Either disconnecting by the appropriate AC circuit breaker or unplugging the first AC connector of the first Microinverter in a branch circuit is suitable as a means of disconnection.



WARNING: The APsystems microinverter is powered by PV module DC power. AFTER disconnecting the DC power, when reconnecting the PV modules to the Microinverter, be sure to watch for the three short LED flashes.



Troubleshooting a non-operating APsystems Microinverter

There are two possible overall areas of trouble:

- A. The Microinverter itself may be having problems.
- B. The Microinverter itself is working fine but it is having trouble communicating with the ECU. The items below refer to Microinverter issues, not communication issues (addressed in the ECU manual).

A quick way to tell whether the issue is the Microinverter or a communication problem with the ECU:

1. **Diagnosing from the Microinverter:** A red light – either blinking or solid on the Microinverter, or no light at all. No light, or a red light, means it is definitely a Microinverter problem.
2. **Diagnosing from the ECU:**
 - a. **No-Data-Display:** This is probably a communication issue- not a Microinverter problem.
 - b. **Problems with erratic display:** Data is displayed for some period and then no data is displayed: most likely a communication issue.
 - c. **0 watts, or 2 watts:** Possibly a Microinverter problem
 - d. **Erratic data display** that is not coordinating with data displays from other units: most likely a Microinverter problem.

To troubleshoot a non-operating APsystems Microinverter, Follow the steps below in order:

1. Verify the utility voltage and frequency are within ranges shown in the Technical Data section of this manual.
2. Check the connection to the utility grid. Verify utility power is present at the inverter in question by removing AC, then DC power. **Never disconnect the DC wires while the microinverter is producing power.** Re-connect the DC module connectors and watch for three short LED flashes.
3. Check the AC branch circuit interconnection between all the microinverters. Verify each inverter is energized by the utility grid as described in the previous step.
4. Make sure that any AC breaker are functioning properly and are closed.
5. Check the DC connections between the microinverter and the PV module.
6. Verify the PV module DC voltage is within the allowable range shown in the Technical Data of this manual.
7. If the problem persists, please call APsystems Customer Support.

WARNING: Do not attempt to repair the APsystems microinverter. If troubleshooting methods fail, please return the microinverter to your distributor for replacement.



Maintenance

No need to Maintenance.

Replace a microinverter

Follow the procedure to replace a failed APsystems Microinverter

- A. Disconnect the APsystems Microinverter from the PV Module, in the order shown below:
 1. Disconnect the AC by turning off the branch circuit breaker.
 2. Disconnect the first AC connector in the branch circuit.
 3. Disconnect the PV module DC wire connectors from the microinverter.
 4. Remove the Microinverter from the PV array racking.
 5. Cover the module with an opaque cover.

- B. Install a replacement Microinverter to the rack. Remember to observe the flashing LED light as soon as the new Microinverter is plugged into the DC cables.

- C. Connect the AC cable of the replacement Microinverter and the neighboring Microinverter to complete the branch circuit connections.

- D. Close the branch circuit breaker, and verify operation of the replacement Microinverter.

Technical Data

WARNING: Be sure to verify the voltage and current specifications of your PV module match with those of the Microinverter. Refer to the APsystems website www.APsystems.com for a list of approved PV modules.



WARNING: You must match the DC operating voltage range of the PV module with the allowable input voltage range of the APsystems Microinverter.



WARNING: The maximum open circuit voltage of the PV module must not exceed the specified maximum input voltage of the APsystems



APsystems YC500I Microinverter Datasheet

Region Europe France Great Britain Germany

Input Data (DC)

Recommended PV Module Power (STC)Range	180W-310W			
MPPT Voltage Range	22V-45V			
MPPT Voltage Range @ Full Power	26V-45V			
Operation Voltage Range	16V-52V			
Maximum Input Voltage	55V			
Startup Voltage	22V			
Maximum Input Current	10.5A x 2			
Maximum DC Short Circuit Current	15A			

Output Data (AC)

Maximum Output Power	500W			
Nominal Output Voltage	230V			
Nominal Output Current	2.17A			
Default/Protect Output Voltage Range	184-253V*	195.5-253V*	200.1-262.2V*	184-264.5V*
Extended/Reconnect Output Voltage Range	149-278V		149-278V	195.5-253V
Nominal Output Frequency	50Hz			
Default/Protect Output Frequency Range	48-51Hz*	47.5-50.6Hz*	47.5-51.5Hz*	47.5-51.5Hz*
Extended/Reconnect Output Frequency Range	45.1-54.9Hz			47.5-50.05Hz
Power Factor	>0.99			
Total Harmonic Distortion	<3%			
Maximum Units per Branch	7 for 20A Breaker**			

Efficiency

Max. Inverter Efficiency	95.5% (With HF Transformer)
Night Power Consumption	120mW

Mechanical Data

Operating Ambient Temperature Range	-40 °F to +149 °F (-40 °C to +65 °C)
Storage Temperature Range	-40 °F to +185 °F (-40 °C to +85 °C)
Dimensions (W x H x D)	221mm X 167mm X 29mm (8.7" X 6.6" X 1.1")
Weight	5.5lbs/2.5kg
AC CABLE (AC BUS) Nominal Current	14AWG :16A 12AWG:20A
Enclosure Rating	IP65
Cooling	Natural Convection
Wet Locations Classification	For Wet Locations
Pollution Degree Classification	PD3
Relative Humidity Ratings	0-95%
Maximum Altitude Rating	All data at this technical Specifications has been tested under <2000m
Overvoltage Category	OVC II for PV input circuit, OVC III for mains circuit

Features & Compliance

Communication	Power line
Design Lifetime	25yrs
Monitoring	Life monitoring via EMA software
Safety and EMC Compliance	EN 62109-1; EN 62109-2;EN61000-6-1; EN61000-6-2; EN61000-6-3; EN61000-6-4;
Grid Connection Compliance	EN50438 VDE0126-1-1/A1*** G83 Issue2 VDE4105 and VDE0126-1-1/A1***

*Programmable through ECU to meet customer need.

**Depending on the local regulations.

***Two switching devices connected in series do not be incorporated within the inverter, external isolation switching devices(like BISI or TELE) which meets the VDE4105(VDE0126-1-1/A1) standard shall be provided.

Specifications subject to change without notice.

© All Rights Reserved

Wiring Diagram

Sample Wiring Diagram - Single Phase

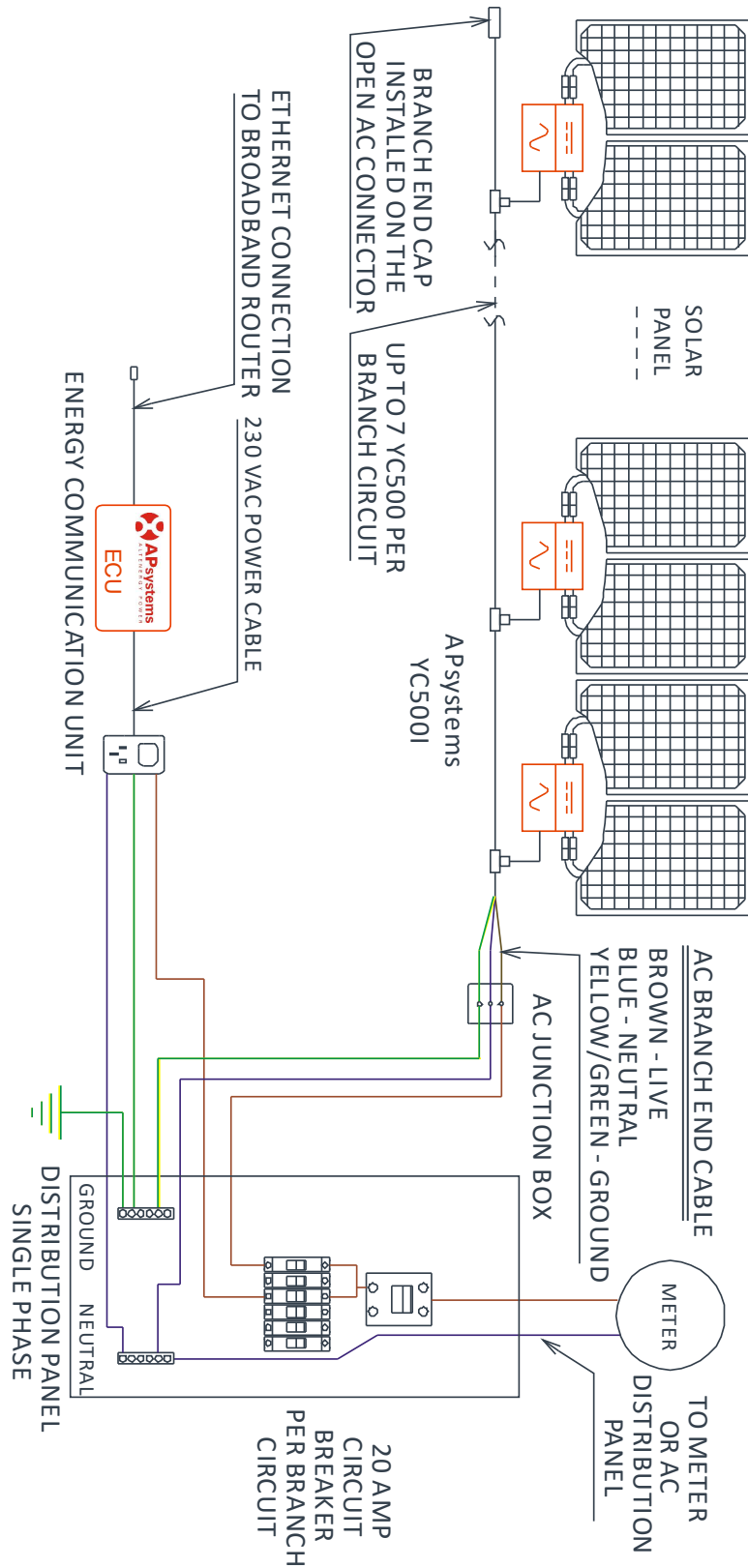

Figure 28

NOTE: Only for countries that using VDE 4105: each phase must be equipped with a NS protection and should not exceed maximum 3.68KVA.



Wiring Diagram

Sample Wiring Diagram - Three Phase

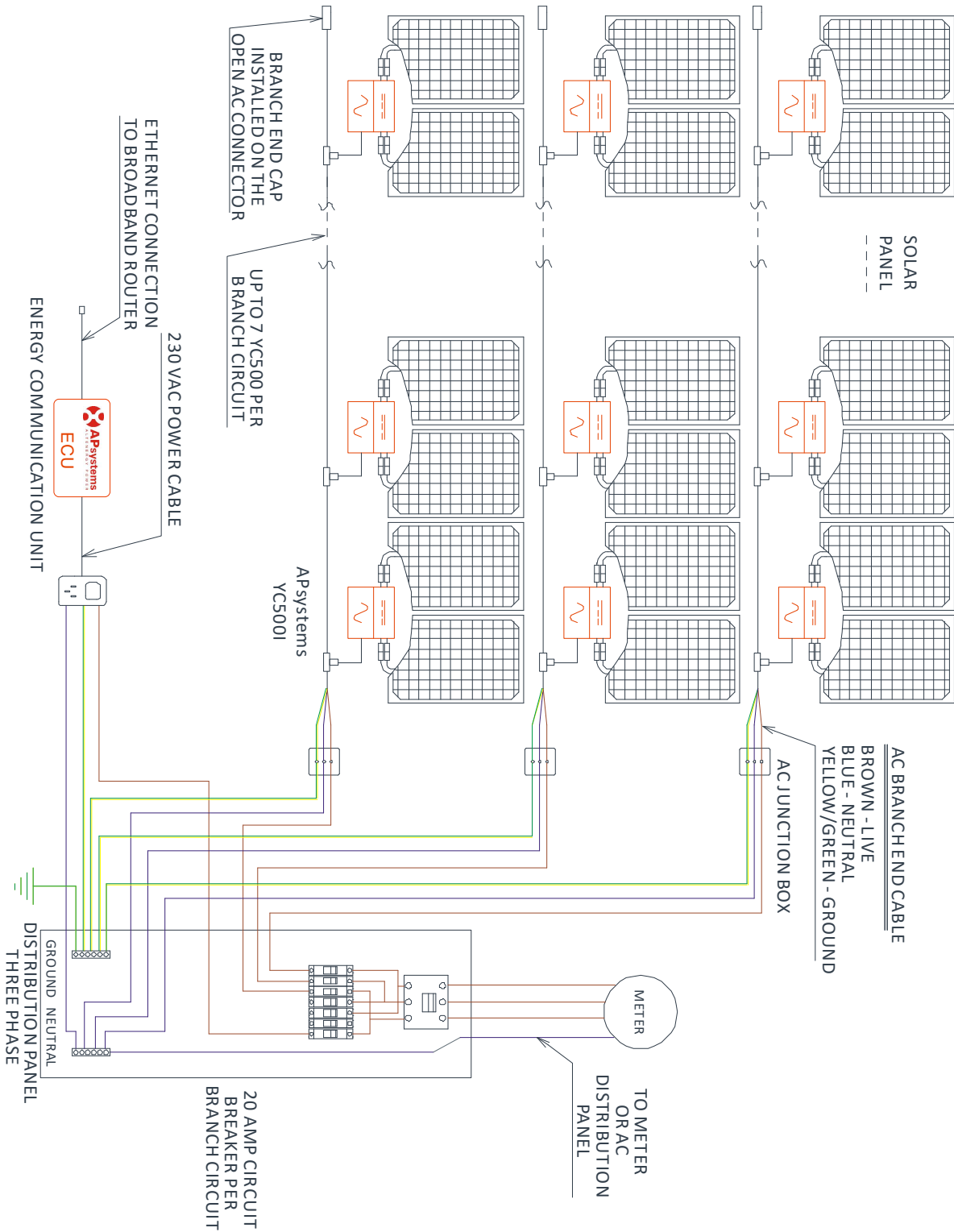

Figure 2

NOTE: Only for countries that using VDE 4105: the power generation system should not exceed 3.68KVA per circuit distributor, the power of each phase should not exceed 3.68KVA and each phase must be equipped with a NS protection. Determined by Grid company ultimately.



APsystems Microinverter & Energy Communication Unit Warranty Card

The APsystems Installation Map is a diagram of the physical location of each microinverter in your PV installation. Each APsystems microinverter has a removable serial number label located on the mounting plate. Peel the label and affix it to the respective location on the APsystems installation map.

Installation Map Template

1	2	3	4	5	6	7	8	9	10	11	12	13	14	15	16	17	18	19	20	21	22

To register your APsystems microinverter, please mail this warranty registration card to: emasupport@altenergy-power.com