



Altenergy Power System

Energy Communication Unit (ECU)

Installation and User Manual

(For ECU-3 V3.10)

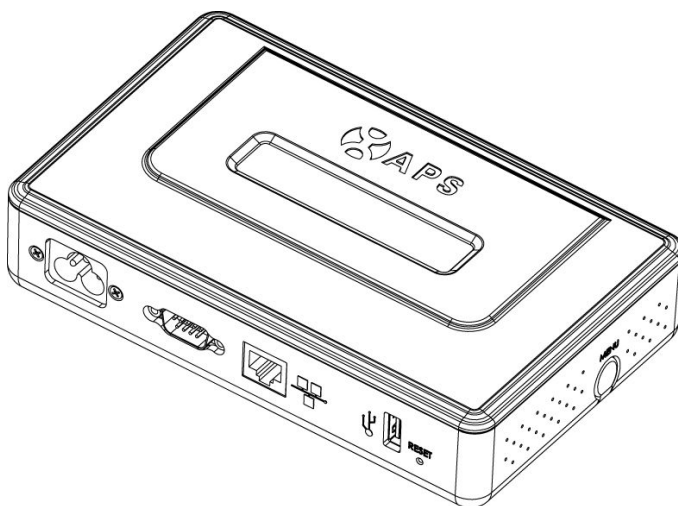

ALTENERGY POWER SYSTEM INC.
All rights reserved

TABLE OF CONTENTS

| | |
|--|----|
| 1.0 Introduction..... | 2 |
| 2.0 Installation..... | 3 |
| 3.0 Interface Explanation..... | 8 |
| 3.1 Interface position..... | 8 |
| 3.2 Power Interface..... | 8 |
| 3.3 RS232 Serial Port..... | 8 |
| 3.4 Network Port..... | 9 |
| 3.5 USB Interface..... | 9 |
| 3.6 RESET..... | 10 |
| 4.0 Basic Operation..... | 10 |
| 4.1 Power Up..... | 10 |
| 4.2 Menu Structure..... | 11 |
| 4.3 Restore the factory set operation..... | 13 |
| 4.4 Troubleshooting..... | 13 |
| 5.0 ECU Local Interface..... | 14 |
| 5.1 Home Screen..... | 14 |
| 5.2 Real-time Data Screen..... | 14 |
| 5.3 Configuration..... | 15 |
| 5.4 Administration Screen..... | 16 |
| 6.0 Technical Data..... | 22 |

1.0 Introduction

The APS-ECU is the information gateway for APS inverters. The APS-ECU is an important gateway to read and store all the information returning by APS microinverters. It can communicate with any type of APS microinverters and provide the real-time data of the PV solar system by monitoring the operation state of the whole system. Equipping with an inside integrated HTTP server is greatly convenient for the users to visit. Based on the user-friendly interface, the users can access in the programme easily and quickly. Multiple options in settings can meet a wide scope of users' needs. No matter what type or quantity of the microinverters is, no matter what connection type of the network is, no matter how far the system has been placed, the ECU can communicate with the APS microinverter regardless of the mentioned weak points.

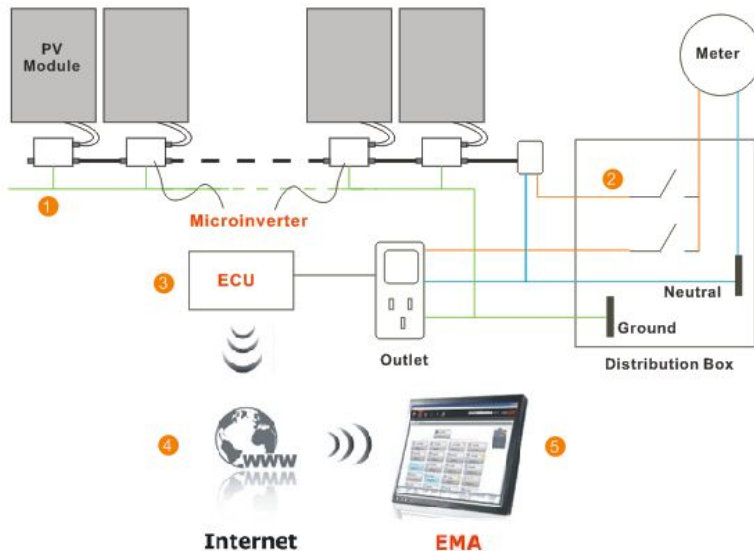

- | | |
|---------------------|-------------------|
| ① APS Microinverter | ② AC power line |
| ③ APS ECU | ④ Ethernet Router |
| ⑤ APS EMA | |

Other Elements in the APS microinverter System

- The APS microinverter is a fully integrated device that converts the DC output of a single solar module into grid-compliant AC electricity.
- The APS web-based Energy Monitoring and Analysis system (EMA) constantly monitors the operation state and analyzes the data collected by the ECU from every microinverter.

ALTENERGY POWER SYSTEM INC. (APS)

2.0 Installation

Preparation

Before installing the ECU, please ensure to meet the following installation requirements:

- Standard AC electrical outlet
- Broadband Internet connection
- Broadband router with Ethernet port or wireless router
- Web browser to view EMA. Support web browsers are Internet Explorer and Firefox

Find a Location for ECU

The ECU can be placed on a table or be mounted on the distribution ark and wall. It is recommended that location for the ECU should be dry and cool. In addition, do not cover the ECU and keep it away from dust.

1) Distribution ark Mounting

- Loosen the two M3 screws that are at the back of the ECU and rotate the holders.

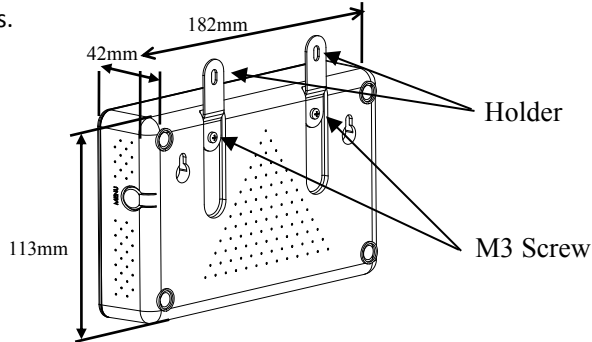

- Fix the ECU on the frame with screws and keep it away from other heat-generating devices.

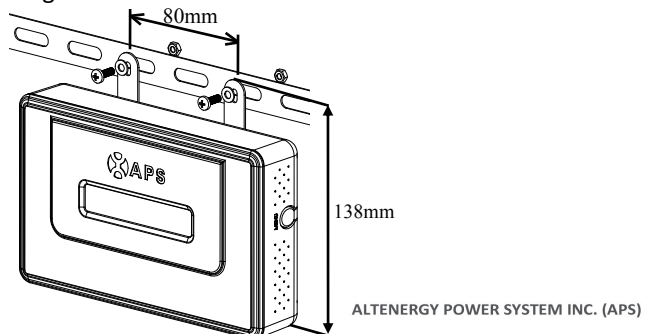

2) Wall Mounting

- Mount the ECU in a cool, dry, indoor location.
- Use two drywall screws or wall anchors to affix the ECU to the wall mounted at the dimensions shown. The maximum screw head diameter is 0.35". Use #8 screws (not included in kit). Affix ECU to the wall with two drywall screws or wall anchors same as the indication as below . The maximum diameter of a screw head is 0.35". We recommend to use #8 screws (not included in kit).
- Slide the ECU onto the mounting screws, aligning the ECU screw holes with the screws installed in step 2. Lower the ECU onto the screw posts to secure the unit to the wall.

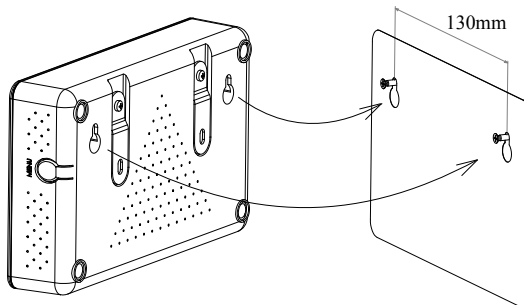

Install the ECU Cable Connections

The following diagram is a guide for the connections on the back of the APS ECU.

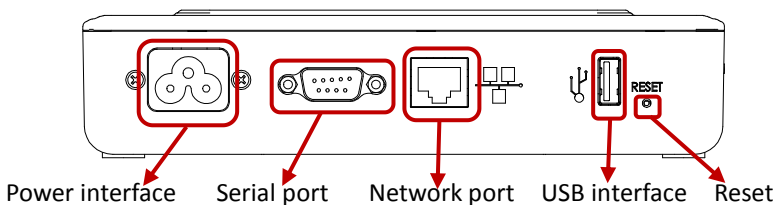

- Connect to Internet
 Option 1: LAN connection - use the LAN Cable to connect ECU to a Broadband Router.
 Plug the Ethernet cable into the network port on the ECU, and plug the other end into a spare port on the broadband router or LAN.

Illustrated as follows:



Without the internet, you can also visit the local web on ECU. Connect one of the network cable ends to ECU and the other to your PC. Then set up the network following steps (e.g. Windows 7): Open Network Connections by clicking the “Start” button, and then clicking “Control Panel”. In the search box, type “adapter”, and then, under Network and Sharing Center, click “View network connections”. Right-click the connection that you want to change, and then click “Properties”. If you’re prompted for an administrator password or confirmation, type the password or provide confirmation. Click the “Networking” tab. Under “This connection uses the following items”, click “Internet Protocol Version 4 (TCP/IPv4)”, and then click “Properties”. Click “Use the following IP address”, and then, in the “IP address” box, type 60.190.131.227, in the “Subnet mask” box, type 255.0.0.0, and then click “OK”.

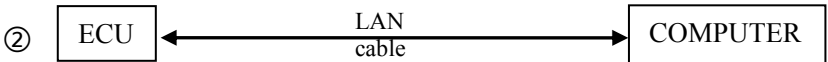

WiFi connection – use WiFi bridge to connect ECU to a Broadband Router.

Configure the WiFi Bridge to connect to Wireless Router, please refer to WiFi Bridge User Manual

Connect the RJ45 LAN Cable and USB Cable on WiFi Bridge to the RJ45 Port and USB Port on ECU

The ECU needs to have a access of a Dynamic Host Configuration Protocol (DHCP) IP address which can be connected to the Internet. The ECU will only search for a DHCP IP address during its power up sequence. ECU will automatically obtain the IP address, such as: 139.168.200.65, and connect to Internet. If the IP address shows “60.190.131.228”, it means ECU fails to get IP address. Make sure the connection between ECU and Router is working well. If not, please reboot ECU and try to obtain IP address again.

- Plug the AC power cord into the AC input on the ECU, and then plug the other end into a standard AC electricity outlet.

Warning: Do not plug any electrical devices and power strip into the same outlet that the ECU is connected to.

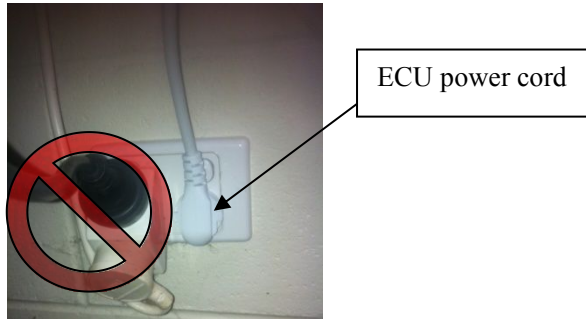

Warning: Do not plug the ECU into a power strip, surge protector, or uninterruptable power supply (UPS). The surge suppression or filtering from these devices can substantially diminish PLC communication performance.

ECU initial setting

Step 1: Power on ECU

The following information will be displayed on LCD after ten seconds.

Initialization Interface:

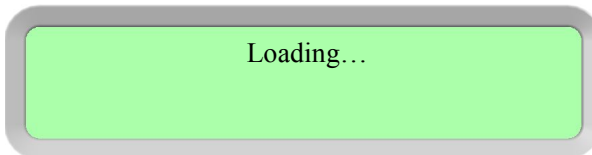

Starting up Interface:

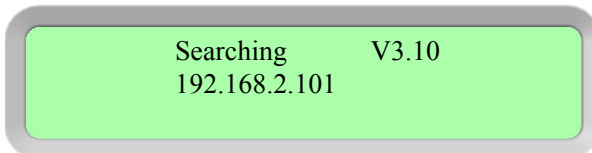

Operation interface:

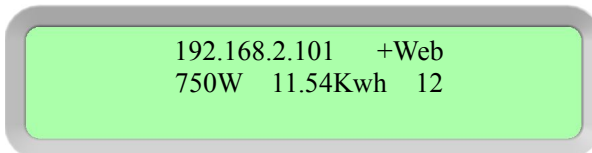

ALTENERGY POWER SYSTEM INC. (APS)

When the communication between the ECU and inverters goes successfully, the LCD will show the readings of your system. The data in operation interface includes:

- Local IP address, for example: 192.169.2.101 (your actual local IP address will be different)
- Web connection information: “+Web”. it means the ECU is connected to EMA. If it is “-Web”, Internet itself has a problem. Need to setup the security authority to offer Auto IP configuration.
- Data of the present power-production in watts, for example: 750W
- Data of the life time output of the system in kWh, for example: 11.54kWh
- The number of online microinverters producing power and reporting in to the ECU, for example: 12

Step 2: ECU time zone setting

- Enter the IP address shown on the ECU LCD into the internet browser, and then open the web page.
- Click “Administration”, then “Date, Time, Time zone”. In the corresponding box, enter local date/time/time zone, click Update after finished. For details, refer to 5.4.2 time management.

Step 3: EMA Monitoring

After ECU display “+web”, contact APS technical staffs in your local area and they will setup an EMA account with User Name and Password.

3.0 Interface Explanation

3.1 Interface position

All of the ECU interface as below, from left to right, are power interface, serial port, network port and USB interface:

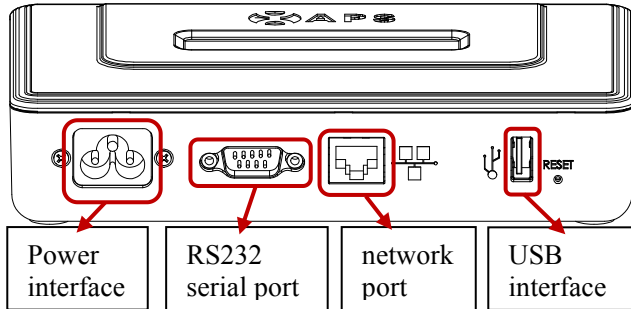

3.2 Power Interface

Power interface connects power through the power line, connection mode as below:



3.3 RS232 Serial Port

You can connect GPRS module to RS232 serial port, select GPRS module to connect to the network on “Network Connectivity” page, and communicate with the EMA, to check the system data.



3.4 Network Port

RJ45 Ethernet network port: ECU allows user to communicate with EMA, and log in ECU's local page, set up the system and view the system data via Ethernet network port. In the case of the absence of the wired network, user can select optional WiFi-Bridge wireless Internet. WiFi-Bridge connection is shown as below:



3.5 USB Interface

In the case of the absence of the wired network, user can select optional WiFi-Bridge wireless Internet. USB interface provides 5V DC power supply for the WiFi-Bridge.

3.6 RESET

press the “Reset” button for three seconds or longer, ECU will automatically return to the default settings.



ATTENTION:The historical power generation won't be cleared.

4.0 Basic Operation

The APS ECU has one two-line, 40-character LCD display with alphanumeric. Set the mode using a single button.

4.1 Power Up

As soon as the ECU is plugged into an AC outlet, it will power up and display several information on screen. The ECU will be ready to work less than in five minutes after powering up. The ECU has completed booting up and has started normal operation when it displays the following information:

Initialization Interface:

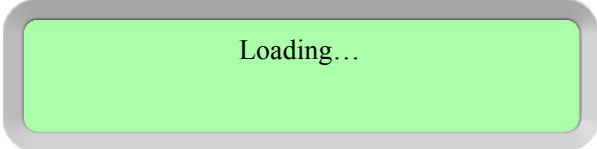

Loading...

Work Started Interface:

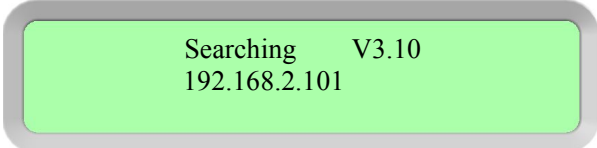

Searching V3.10
192.168.2.101

The V3.10 indicates the firmware version from which the ECU’s operation and features are dictated. After the ECU receives an IP address and establishes an Internet connection, the ECU will contact a Network Time Protocol (NTP) server so that it can set an accurate local time.

Normal Work Interface:

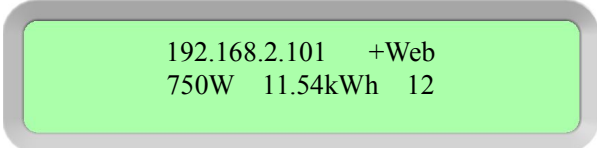

192.168.2.101 +Web
750W 11.54kWh 12

The number 12 indicates the number of panels to which the ECU is connected.

The symbol “!” following the number 12 indicates that the number of microinverters connected to the ECU doesn’t match the number programmed into the ECU.

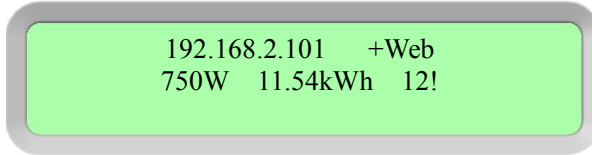

ATTENTION: ECU functions as a gateway and monitors the microinverters that are connected to the PV modules. Therefore, the communication between inverters and ECU does not affect inverters' performance, even if ECU drops inverters. The power production data collected by ECU is for reference only, please check the power meter for the real power production of the whole system.

4.2 Menu Structure

The following figure shows the ECU side of the button:

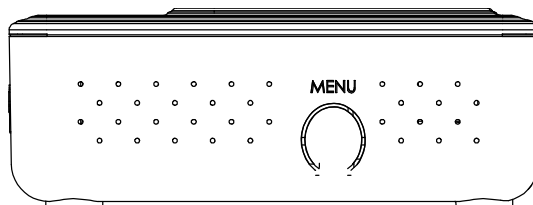

You can access the ECU LCD panel menu by pressing and holding the Menu button; after two seconds you will enter the ECU menu. Continue holding the button, and menu items will appear operational orders as following:

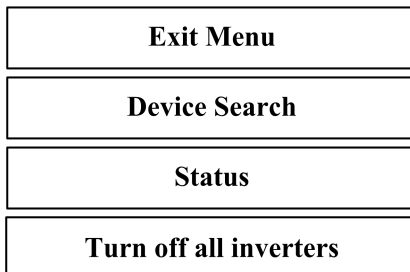

Continue holding the Menu button. When the LCD displays “Device Search,” release the Menu button. The following display will appear:

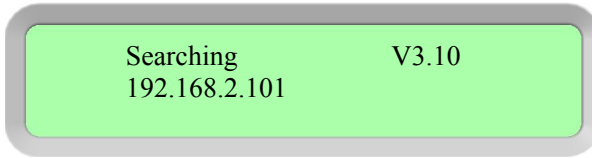

Enter the ECU menu. Hold the Menu button until the LCD displays “Status”. Release the Menu button, and the following items will be appeared:

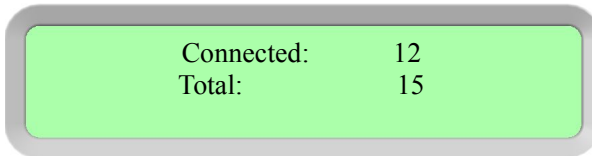

The numbers above mean that there are 15 sets of microinverters that should have been connected to the ECU while in fact, there are only 12 sets of microinverters to be connected.

Enter the ECU menu. Hold the Menu button until the LCD displays: “Turn off all inverters.” Release the Menu button, and the following items will appear:

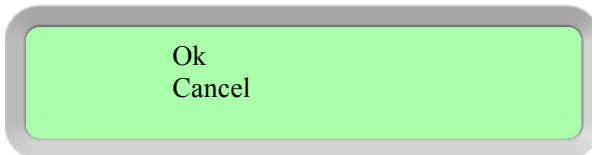

Choose “Ok”, and the system of inverter will be turned off. Choose “Cancel”, ECU will exit the menu. If within one minute without pressing the button again, then automatically exit the menu button.



ATTENTION: the above operation should be done under the guidance of technician.

4.3 Restore the factory set operation

The following diagram guides to the connectors back of APS-ECU.

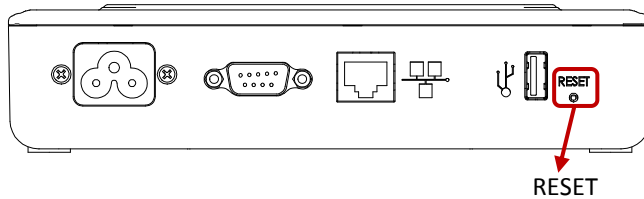

For the ECU restoring the factory set, simply press the “Reset” button for three seconds or longer, ECU will automatically return to the default settings.

4.4 Troubleshooting

Potential Problems and Solutions

IP Address Problem: If the IP address displayed on the ECU’s LCD does not match the subnet on your internal network and shows “60.190.131.228”, it means that it was unsuccessful in obtaining a DHCP IP address from your router.

- Check network connectivity to the router or other DHCP server. You may need to contact your Internet Service Provider or refer to your router documentation for troubleshooting assistance.

LCD Displays “-Web”: The ECU could not connect to the APS website.

- Check network connectivity to the router. You may need to contact your Internet Service Provider or refer to your router documentation for troubleshooting assistance.

LCD Display “!”: The number of installed units doesn’t match the microinverter-count. This may indicate that the ECU is having difficulty communicating over the power lines. It could also be caused by low light levels, resulting in module voltage that is too low for the microinverter to power up.

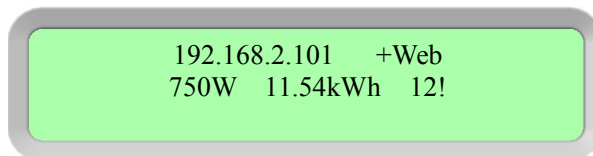

- Plug the ECU into an electrical socket in a different location. Keep it away from your router.

5.0 ECU Local Interface

Connection to APS's web-based monitoring and analysis website (EMA) requires an Internet connection. If the users want to check data information from ECU, please make sure that the ECU is connected with internet. However, if there is no Internet access at the installation site, it is still possible to communicate directly with the ECU local interface using the Ethernet port and a personal computer with a web browser.

5.1 Home Screen

Once the browser has successfully connected with the ECU, the following screen is displayed in the browser. This home screen provides a system overview and shows the current status of the microinverters that have been identified by the ECU. From this screen, you can access other screens in the interface.

[Home](#)

 [Real Time Data](#)

 [Configuration](#)

 [Administration](#)

| | |
|---------------------------------|---------------------|
| ECU ID | 203000002339 |
| Lifetime generation | 3.34 kWh |
| Last System Power | 327 W |
| Generation Of Current Day | 0.24 kWh |
| Last connection to website | 2014-10-11 14:34:02 |
| Number of Inverters | 2 |
| Last Number of Inverters Online | 2 |
| Current Software Version | V3.10 |
| Database Size | 47 kB |
| Current Timezone | Asia/Shanghai |
| ECU Mac Address | 80:97:1B:00:09:8C |

5.2 Real-time Data Screen

To view the real-time system operation data statistics for your solar array, click “Real Time Data” from the ECU home screen to navigate to the real-time data screen.

[Home](#)

 [Real Time Data](#)

 [Configuration](#)

 [Administration](#)

| Inverter ID | Current Power | Grid Frequency | Grid Voltage | Temperature | Date |
|----------------|---------------|----------------|--------------|-------------|---------------------|
| 404000099634-A | 182 W | 50.0 Hz | 222 V | 33 °C | 2014-10-15 12:48:47 |
| 404000099634-B | 0 W | 50.0 Hz | 222 V | 33 °C | 2014-10-15 12:48:47 |
| 404900022078-A | 144 W | 50.0 Hz | 220 V | 43 °C | 2014-10-15 12:48:47 |
| 404900022078-B | 0 W | 50.0 Hz | 220 V | 43 °C | 2014-10-15 12:48:47 |

5.3 Configuration

Configure the inverter protection parameters. Click “Parameters”, type the values in the “Undervoltage Slow” box, “Overvoltage Slow” box, “Underfrequency Slow” box, “Overfrequency Slow” box and “Grid Recovery Time” box, then click “Save”, the inverters’ protection parameters will be set. Then click “Parameters” to view the actual protection parameters set on the inverters in a few minutes. As shown below:

[Home](#) [Real Time Data](#) [Configuration](#) [Administration](#)

[Parameters](#) [GFDI](#) [Remote Control](#)

ALL ▾

| | | |
|---------------------|------|-----|
| Undervoltage Slow | 150 | V |
| Overvoltage Slow | 250 | V |
| Underfrequency Slow | 49.0 | Hz |
| Overfrequency Slow | 51.0 | Hz |
| Grid Recovery Time | 300 | Sec |

Save

Read Parameters From Inverters

| Inverter ID | Undervoltage Slow | Overvoltage Slow | Underfrequency Slow | Overfrequency Slow | Grid Recovery Time |
|--------------|-------------------|------------------|---------------------|--------------------|--------------------|
| 404000099634 | 148 | 250 | 48.0 | 53.0 | 300 |
| 404900022078 | 150 | 250 | 49.0 | 51.0 | 300 |

Click “GFDI”, select the check box, then click “Clear GFDI”. The GFDI flag of inverters will be cleared soon.

[Home](#) [Real Time Data](#) [Configuration](#) [Administration](#)

[Parameters](#) [GFDI](#) [Remote Control](#)

| Inverter ID | Status | Clear GFDI |
|--------------|--------|--------------------------|
| 404000099634 | Normal | <input type="checkbox"/> |
| 404900022078 | Normal | <input type="checkbox"/> |

Clear GFDI

Click “Remote Control”, select “Turn On” or “Turn Off” check box, then click “Turn On/Off” to turn on or turn off inverters. The inverters will be turned on or turned off soon. You can also click “Turn on all inverters” or “Turn off all inverters” to turn on or turn off all inverters.

| Inverter ID | Turn On | Turn Off |
|--------------|--------------------------|--------------------------|
| 404000099634 | <input type="checkbox"/> | <input type="checkbox"/> |
| 404900022078 | <input type="checkbox"/> | <input type="checkbox"/> |

Turn On/Off

Turn on all inverters

Turn off all inverters

5.4 Administration Screen

For the user to set up the ECU parameters

1) ID Management

For the user to input 12 digits inverter ID, each input the ID number and press "Enter" a line break, then enter the next inverter ID, all inverter ID into finish, press the "ok" button, the input completed. As shown below:

Enter Inverter ID:

104000000234

104000000235

104000000235

104000000237

OK

Clear ID

If the number of inverter ID displayed on the page is less than the actual number of inverters installed, you can enter the lost inverters ID to "Input Inverter ID" section, then click "OK".

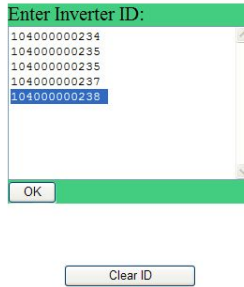

If the number of inverter ID displayed on the page is more than the actual number of inverters installed, you can remove the redundant inverters ID from “Input Inverter ID” section, then click “OK”.

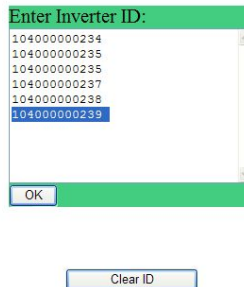

Enter Inverter ID:

- 104000000234
- 104000000235
- 104000000235
- 104000000237
- 104000000238

OK

Clear ID

If the inverter ID displayed on the page is discrepancy with the actual inverters ID installed, please modified the wrong inverters ID from “Input Inverter ID” section, then click “OK”.

Enter Inverter ID:

- 104000000234
- 104000000235
- 104000000235
- 104000000237
- 104000000999

OK

Clear ID

Enter Inverter ID:

104000000234

104000000235

104000000235

104000000237

104000000238

Click “Clear ID”, ID will be cleared.

Inverter ID were successfully Cleared!

2) Time management

In date column, input date, format for day/month/year, in time column, input time, format for hour/minute/second, after the completion of the input, click on the "ok" button. The ECU also can connect to the NTP server for obtaining accurate date and time automatically. In "NTP server" Spaces place, users can set NTP server address. As shown below:

| | | | |
|-------------------------------|------------------------------------|-------------------------------|--------------------------------------|
| Home | Real Time Data | Configuration | Administration |
| ID Management | Date.Time.Timezone | Language | Network Connectivity |

Date:
07/11/2013

Time:
12:23:13

Time Zone: [Current Time Zone: Asia/Shanghai]

Select Time Zone

NTP Server:
0.asia.pool.ntp.org

3) Language management. Users can switch language between Chinese and English. As shown below:

| | | | |
|-------------------------------|------------------------------------|-------------------------------|--------------------------------------|
| Home | Real Time Data | Configuration | Administration |
| ID Management | Date.Time.Timezone | Language | Network Connectivity |

Current language: [English]

Select a language

English

Simplified Chinese

4) Network management. Users can choose to connect to the internet through GPRS or Ethernet by setting the ECU internet connection modes. Check "Use GPRS Module" and click "update" to run the GPRS module. Uncheck "Use GPRS Module" and click "update" to use Ethernet. Checking "Use DHCP" and clicking "update", ECU can automatically acquire a dynamic IP address from Ethernet. To use a static IP address, you need to fulfill the IP address, Netmask, Gateway IP, Primary DNS Server and Secondary DNS Server got from network administrator.

ALTENERGY POWER SYSTEM INC. (APS)

| |
|--|
| <input type="checkbox"/> Use GPRS Module |
| <input type="button" value="Update"/> |
| <input checked="" type="checkbox"/> Use DHCP |
| <input type="button" value="Update"/> |
| IP address for interface 0: |
| <input type="text"/> |
| Netmask: |
| <input type="text"/> |
| Gateway IP: |
| <input type="text"/> |
| Primary DNS Server: |
| <input type="text"/> |
| Secondary DNS Server: |
| <input type="text"/> |
| <input type="button" value="Update"/> |



Notes: The network cable in the package is used for the users to connect the ECU with PC directly. One side is connected with the ECU and the other side is connected with the PC. Then change the IP address and the network mask into 60.190.131.1 and 255.0.0.0 respectively.

6.0 Technical Data

| | |
|--------------------------------|---|
| Model: ECU-3 | |
| Communication Interface | |
| Power Line | APS Proprietary |
| Ethernet | 10/100M Auto-sensing, Auto-negotiation |
| USB interface | Standard |
| RS232 | Standard |
| Power Requirements | |
| AC Outlet | 110 ~ 240 VAC, 50 ~ 60 Hz |
| Power Consumption | 2.5 W |
| Mechanical Data | |
| Dimensions(W×H×D) | 182 mm × 113 mm × 42 mm |
| Weight | 380 g |
| Ambient Temperature Range | -40°C to +65°C |
| Cooling | Nature Convection; No Fans |
| Enclosure Environmental Rating | Indoor - NEMA 1(IP30) |
| Features | |
| Standard Warranty Term | 3 Years |
| Compliance | IEC 60950-1, EN60950-1, IEC 60529, EN 60529, ANSI/UL 60950-1, CAN/CSA C22.2 No.60950-1, UL50E, FCC part 15, EN61000-6-1, EN61000-6-3, ICES-003, AS NZS 60950-1, GB/T17799 |

This device complies with part 15 of the FCC Rules. Operation is subject to the following two conditions: (1) This device may not cause harmful interference, and (2) this device must accept any interference received, including interference that may cause undesired operation.

This Class B digital apparatus complies with Canadian ICES-003.

:: WEEE (for Europe)



Disposal of your old appliance

1. When this crossed-out wheeled bin symbol is attached to a product, it means the product is covered by the European Directive 2002/96/EC.
2. All electrical and electronic products should be disposed of separately from the municipal waste stream via designated collection facilities appointed by the government or the local authorities.
3. The correct disposal of your old appliance will help prevent potential negative consequences for the environment and human health.
4. For more detailed information about disposal of your old appliance, please contact your city office, waste disposal service or the shop where you purchased the product.

Contact Information

ALTENERGY POWER SYSTEM Inc.
1 Yatai Road, Jiaxing, PR China 314050
Phone: +86-21-68889199
Fax: +86-21-33928752
www.APSmicroinverter.com

