

	INDOOR UNIT	OUTDOOR UNIT
MODEL CODE	AR50F07C1AHNEU	AR50F07C1AHXEU
	AR50F09C1AHNEU	AR50F09C1AHXEU
	AR50F12C1AHNEU	AR50F12C1AHXEU
	AR50F15C1AHNEU	AR50F15C1AHXEU
	AR50F18C1AHNEU	AR50F18C1AHXEU
	AR50F24C1AHNEU	AR50F24C1AHXEU
	AR60F07C1AWNEU	AR60F07C1AWXEU
	AR60F09C1AWNEU	AR60F09C1AWXEU
	AR60F12C1AWNEU	AR60F12C1AWXEU
	AR60F18C1AWNEU	AR60F18C1AWXEU
	AR60F24C1AWNEU	AR60F24C1AWXEU
	AR70F07C1ABNEU	AR70F07C1AWXEU
	AR70F07C1AWNEU	AR70F07C1AWXEU
	AR70F07CAAWNEU	AR70F07CAAWXEU
	AR70F09C1ABNEU	AR70F09C1AWXEU
	AR70F09C1AWNEU	AR70F09C1AWXEU
	AR70F09CAAWNEU	AR70F09CAAWXEU
	AR70F12C1ABNEU	AR70F12C1AWXEU
	AR70F12C1AWNEU	AR70F12C1AWXEU
	AR70F12CAAWNEU	AR70F12CAAWXEU
AR70F15C1AWNEU	AR70F15C1AWXEU	
AR70F18C1AWNEU	AR70F18C1AWXEU	
AR70F24C1AWNEU	AR70F24C1AWXEU	
AR50F18C1BHNEU	AR50F18C1BHXEU	
AR50F24C1BHNEU	AR50F24C1BHXEU	

SERVICE Manual

AIR CONDITIONER



AR50F07C1AHNEU
AR50F09C1AHNEU
AR50F12C1AHNEU
AR50F15C1AHNEU
AR50F18C1AHNEU
AR50F24C1AHNEU



AR60F07C1AWNEU
AR60F09C1AWNEU
AR60F12C1AWNEU
AR60F18C1AWNEU
AR60F24C1AWNEU
AR70F07C1AWNEU
AR70F07CAAWNEU
AR70F09C1AWNEU
AR70F09CAAWNEU
AR70F12C1AWNEU
AR70F12CAAWNEU
AR70F15C1AWNEU
AR70F18C1AWNEU
AR70F24C1AWNEU



AR50F07C1AHXEU
AR50F09C1AHXEU
AR50F12C1AHXEU
AR60F09C1AWXEU
AR60F12C1AWXEU



AR50F15C1AHXEU
AR70F07C1AWXEU
AR70F07C1AWXEU
AR70F09C1AWXEU
AR70F09C1AWXEU
AR70F09CAAWXEU
AR70F12C1AWXEU
AR70F12C1AWXEU
AR70F12CAAWXEU
AR70F15C1AWXEU



AR50F18C1AHXEU
AR50F24C1AHXEU
AR60F18C1AWXEU
AR60F24C1AWXEU
AR70F18C1AWXEU
AR70F24C1AWXEU

CONTENTS

1. Precautions
2. Product Specifications
3. Alignment and Adjustments
4. Disassembly and Reassembly
5. ASSY CONTROL
6. Wiring Diagram
7. PCB Diagram
8. Operating Instructions
9. Troubleshooting
10. Block Diagram
11. Reference Sheet

Contents

1. Precautions	5
1-1 Installing the air conditioner	5
1-2 Power supply and circuit breaker	5
1-3 During operation	5
1-4 Disposing of the unit	6
1-4 Others	6
2. Product Specifications	7
2-1 The Feature of Product	7
2-2 Product Specifications	8
2-3 The comparative specifications of product	14
2-4 Accessory and option specifications	17
3. Alignment and Adjustments	18
3-1 Test mode	18
3-2 Display Error and Check Method	19
3-3 Setting Option Setup Method	21
4. Disassembly and Reassembly	27
4-1 Indoor Unit	28
4-2 Outdoor Unit	38
5. ASSY CONTROL	53
5-1 ASSY KIT INDOOR CODE DB92-05830A, D, K ,M	53
5-2 ASSY KIT OUTDOOR CODE DB92-05824A	54
5-3 ASSY KIT OUTDOOR CODE DB92-05824D	55
5-4 ASSY KIT OUTDOOR CODE DB92-05824L	56
5-5 ASSY KIT OUTDOOR CODE DB92-05845A	57
6. Wiring Diagram	58
6-1 Indoor unit	58
6-2 Outdoor unit	59
7. PCB Diagram	60
7-1 Indoor Main PCB CODE DB92-05822A	60
7-2 Outdoor Main PCB CODE DB92-05826A	61
7-3 Outdoor Main PCB CODE DB92-05826A	63
7-4 DISPLAY PCB	65
7-5 Wire connecting the indoor unit terminal blocks	66
8. Operating Instructions	67
8-1 Name of Each Part	67
8-2 Wireless Remote Control-Buttons and Display	69

Contents

9. Troubleshootin	71
9-1 Items to be checked First	71
9-2 Communication Error	72
9-2-1 Communication Error	72
9-2-2 Indoor temperature sensor Error	73
9-2-3 Indoor fan motor speed detecting error (BLDC fan)	74
9-2-4 Outdoor temperature sensor error	75
9-2-5 Outdoor Cond temperature sensor error	76
9-2-6 Outdoor Discharge temperature sensor error	77
9-2-7 Operation condition secession error	78
9-2-8 EEPROM error	79
9-2-9 Compressor starting error	80
9-2-10 Compressor wire missing error/rotation error	81
9-2-11 Current sensor error/Input current sensor error	82
9-2-12 O.C(Over Current) error	83
9-2-13 No power outdoor (Initial Diagnosis) (Not displayed)	85
9-2-14 NWhen the Up/Down, Left/Right louver motor does not operate (Initial Diagnosis)(Not displayed)	86
9-2-15 When the remote control is not receiving	87
9-2-16 Smart Install error	88
9-2-17 EEV or VALVE CLOSE error (C422)	89
9-2-18 Outdoor fan motor errors	90
9-2-19 Set option error	91
9-2-20 COMP DOWN DUE TO HIGH PRESSURE SWITCH OPEN ERROR	92
9-2-21 OTP error	93
9-2-22 Fan starting error	94
9-2-23 O.C(Over Current) error	95
9-2-24 AC INPUT VOLTAGE SENSOR ERROR	97
9-2-25 COMP DC-LINK VOLTAGE SENSOR ERROR	98
9-2-26 FAN DC-LINK VOLTAGE SENSOR ERROR	99
9-2-27 DC-LINK VOLTAGE UNDER/OVER ERROR	100
9-2-28 COMP CONTROLLER PCB OVERHEAT	101
9-2-29 FAN CONTROLLER PCB OVERHEAT	102
9-2-30 COMP HEATSINK SENSOR ERROR	103
9-2-31 FAN HEATSINK SENSOR ERROR	104
9-2-32 FAN HEATSINK OVER TEMP ERROR	105
9-2-33 COMP HEATSINK OVER TEMP ERROR	106
9-2-34 COMP CURRENT SENSOR ERROR	107
9-2-35 FAN CURRENT SENSOR ERROR	108
9-2-36 COMP V_LIMIT/I_LIMIT ERROR	109
9-2-37 FAN V_LIMIT / I_LIMIT ERROR	110
9-2-38 INPUT CURRENT SENSOR ERROR	111
9-2-39 PFC OVER LOAD ERROR	112
9-2-40 OVER VOLTAGE PROTECTION ERROR	113
9-2-41 GAS SHORTAGE ERROR / GAS LEAK ERROR	114
9-2-42 FAN WIRE MISSING ERROR/ROTATION ERROR	115
9-2-43 Diagnosis of Inverter PBA using HASS tool	116

10. Block Diagram	117
10-1 Indoor unit	117
10-2 Outdoor unit	118
11. Reference Sheet	121
11-1 Low Refrigerant Pressure Distribution	121
11-2 Pressure & Capacity mark	121
11-3 Q & A for Non-trouble	122
11-4 Cleaning /Filter Change	125
11-5 Installation	128
11-6 Installation Diagram of Indoor Unit and Outdoor Unit	129
11-7 Reference sheet	131

1. Precautions

1-1 Installing the air conditioner

- User should not install the air conditioner by themselves. Ask the dealer or authorized company to install the air conditioner except window-type air conditioner in U.S.A and Canada.
- If you don't install the air conditioner properly, it may cause a fire, a water leakage or an electric shock.
- You must install the air conditioner according to the national wiring regulations and safety regulations.
- Install the indoor unit higher than 2.5m from the floor to avoid injury caused by the operation of the fan. (except the window-type air conditioner)
- The manufacturer is not responsible for any accidents or injury caused by an incorrect installation.
- When installing the built-in type air conditioner, keep all electric cables such as the power cable and the connection cord in pipes, ducts, or cable channels to protect them from the danger of impact or any other incidents.

1-2 Power supply and circuit breaker

- If the power cord of the air conditioner is damaged, it must be replaced by the manufacturer or a qualified person in order to avoid a hazard.
- The air conditioner must be plugged into an independent circuit if applicable or connect the power cable to the auxiliary circuit breaker. An all pole disconnection from the power supply must be incorporated in the fixed wiring with a contact opening of >3mm.
- Do not extend an electric power cord to the air conditioner.
- The air conditioner must be plugged in after you complete the installation.

1-3 During operation

- Do not repair the air conditioner at your discretion. It is recommended to contact a service center directly.
- Never spill any kind of liquid on the air conditioner. If this happens, turn off the air conditioner and contact an authorized service center.
- Do not insert anything between the airflow blades to prevent damage to the inner fan and consequent injury. Keep children away from the air conditioner.
- Do not place any obstacles in front of the air conditioner.
- Do not spray any kind of liquid into the indoor unit. If this happens, turn off the air conditioner and contact a service center.
- Make sure that the air conditioner is well ventilated at all times. Do not place a cloth or other materials over it.
- Remove the batteries if you don't use the remote control for a long time. (If applicable)
- Use the remote control within 7 meters from the indoor unit. (If applicable)

1-4 Disposing of the unit

- Before disposing the air conditioner, remove the batteries from the remote control.
- When you dispose of the air conditioner, consult your dealer. If pipes are removed incorrectly, refrigerant may blow out and cause air pollution. When it contacts with your skin, it can cause skin injury.
- The package of the air conditioner should be recycled or disposed of properly for environmental reasons.

1-5 Others

- Never store or load the air conditioner upside down or sideways to prevent the damage to the compressor.
- Young children or infirm persons should always be supervised when they use the air conditioner.
- Max current is measured according to IEC standard for safety.
- Current is measured according to ISO standard for energy efficiency.

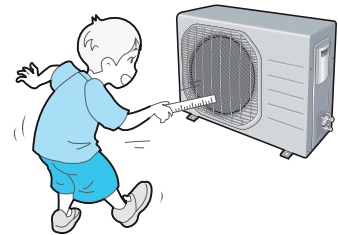

2. Product Specifications

2-1 The Feature of Product

- ◆ **Fast cooling**

If you want strong and cool air, just select Fast function! It will get you the strongest air!

- ◆ **WindFree Cooling**

Use the WindFree Cooling function to enjoy a mild breeze coming through fine holes in the WindFree panel instead of air coming directly through the air outlet.

- ◆ **Eco**

Use the Eco function when you're alone at home. Aside from energy savings from the inverter technology, the Eco Mode will further minimize your energy consumption and reduce your electricity bill by adjusting the maximum operating capacity of the compressor.

- ◆ **Easy Filter**

There is no grille to remove before separating the filter from the air conditioner! Therefore, filter can be cleaned easily and more frequently. Constant filter cleaning will prevent dust from entering the product or accumulating on the filter.

- ◆ **good'sleep function**

good'sleep function will allow you to have deep, good night's sleep by adjusting the temperature, fan speed and air flow direction.

- ◆ **Smart Install**

When the installation is done, your product will examine itself through trial operation to check if it was installed properly.

- ◆ **Easy Installation**

It's so easy to install! An installer can easily hang the product on the wall and connect the pipes and wires by opening the cover on the bottom of the product. No need to tilt the product to connect the pipe and the wires!

2-2 Product specification

Model			AR50F07C1AH/EU	AR50F09C1AH/EU	AR50F12C1AH/EU	AR50F15C1AH/EU
Rating	Mode	Unit	Wall-mounted	Wall-mounted	Wall-mounted	Wall-mounted
Capacity	T1 Cool	W	2000	2500	3500	4300
	T3 Cool	W	-	-	-	-
	Heat	W	2200	3200	3500	4300
Power Input	T1 Cool	W	460	600	1060	1270
	T3 Cool	W	-	-	-	-
	Heat	W	470	850	930	1240
Current	T1 Cool	A	2.4	2.9	4.7	5.6
	T3 Cool	A	-	-	-	-
	Heat	A	2.5	3.8	4.2	5.5
Efficiency	EER	W/W	4.35	4.17	3.30	3.39
	-	-	-	-	-	-
	COP	W/W	4.68	3.76	3.76	3.47
Dehumidifying		l/hr.	2.5	2.5	2.5	2.5
Platform	IDU	-	Q1	Q1	Q1	Q1
	ODU	-	SG85	SG85	SG85	N-SI
Evap	Main	-	Φ7, 2R*9(10)S*591mm, H1.3, Hydrophilic, 2by2	Φ7, 2R*9(10)S*591mm, H1.3, Hydrophilic, 2by2	Φ7, 2R*9(10)S*591mm, H1.3, Hydrophilic, 2by2	Φ7, 2R*9(10)S*591mm, H1.3, Hydrophilic, 2by2
	Sub	-	Φ7, 2R*5(6)S*591mm, H1.3, Hydrophilic : (S1-6)	Φ7, 2R*5(6)S*591mm, H1.3, Hydrophilic : (S1-6)	Φ7, 2R*5(6)S*591mm, H1.3, Hydrophilic : (S1-6)	Φ7, 2R*5(6)S*591mm, H1.3, Hydrophilic : (S1-6)
Cond	Main	-	Φ7W, 2R*24S*620.5mm, Corrugate1.5, Hydrophilic, 2by2	Φ7W, 2R*24S*620.5mm, Corrugate1.5, Hydrophilic, 2by2	Φ7W, 2R*24S*620.5mm, Corrugate1.5, Hydrophilic, 2by2	Φ7W, 2R*24S*850/825mm, Corrugate1.5, Hydrophilic, 4by4by2
	Sub	-	-	-	-	-
Comp	Model	-	UB1TC5102FJ6	UB1TC5102FJ6	UB1TC5102FJ6	KTN130D42UFR
	OLP	-	-	-	-	-
Motor In	Code	-	DB31-00636A	DB31-00636A	DB31-00636A	DB31-00636A
	Name	-	-	-	-	-
Motor Out	Code	-	DB31-00706A	DB31-00706A	DB31-00706A	DB31-00706A
	Name	-	-	-	-	-
Expansion	Φ * L	-	T01 Φ1.3 [54]	T01 Φ1.3 [54]	T01 Φ1.3 [54]	T01 Φ1.3 [54]
Refrigerant	type	-	R32	R32	R32	R32
	charge	g	700 g	700 g	700 g	930 g
SVC Valve	Liquid / Gas	-	Φ6.35/Φ9.52	Φ6.35/Φ9.52	Φ6.35/Φ9.52	Φ6.35/Φ9.52
Tube	Dis. / Suc.	-	Φ7.94/Φ9.52	Φ7.94/Φ9.52	Φ7.94/Φ9.52	Φ9.52/Φ12.7
Drain hose	D * L	mm	20*550	20*550	20*550	20*550
4-WAY V/V		-	-	-	-	-
Power Supply		V/Hz/Φ	220-240/50/1	220-240/50/1	220-240/50/1	220-240/50/1
Climate Class		-	T1	T1	T1	T1
Noise	IDU UT,T	dB	41 / 54 dB↓	41 / 54 dB↓	43 / 56 dB↓	48 / 58 dB↓
	ODU	dB	51 / 60 dB↓	51 / 63 dB↓	53 / 63 dB↓	57 / 65 dB↓
Net Size (W*D*H)	IDU	mm	820*299*215	820*299*215	820*299*215	820*299*215
	ODU	mm	710*540*220	710*540*220	710*540*220	790*548*285
Weight	IDU	kg	9.1	9.1	9.1	9.1
	ODU	kg	24	24	24.4	30.7
Operation range	Cooling	IDU	16 ~ 32 °C	16 ~ 32 °C	16 ~ 32 °C	16 ~ 32 °C
		ODU	-10 ~ 46 °C	-10 ~ 46 °C	-10 ~ 46 °C	-10 ~ 46 °C
	Heating	IDU	27 °C or less	27 °C or less	27 °C or less	27 °C or less
		ODU	-15 ~ 24 °C	-15 ~ 24 °C	-15 ~ 24 °C	-15 ~ 24 °C

2-2 Product specification

Model			AR50F18C1AH/EU	AR50F24C1AH/EU	AR60F09C1AW/EU	AR60F12C1AW/EU
Rating	Mode	Unit	Wall-mounted	Wall-mounted	Wall-mounted	Wall-mounted
Capacity	T1 Cool	W	5000	6500	2500	3500
	T3 Cool	W	-	-	-	-
	Heat	W	6000	7400	3200	4000
Power Input	T1 Cool	W	1390	1950	625	990
	T3 Cool	W	-	-	-	-
	Heat	W	1610	2200	770	1020
Current	T1 Cool	A	6.4	8.8	2.9	4.4
	T3 Cool	A	-	-	-	-
	Heat	A	7.8	9.8	3.4	4.5
Efficiency	EER	W/W	3.60	3.33	4.00	3.54
	-	-	-	-	-	-
	COP	W/W	3.73	3.36	4.16	3.92
Dehumidifying		l/hr.	2.5	2.5	2.5	2.5
Platform	IDU	-	Q3	Q3	QF2	QF2
	ODU	-	Q-480	Q-480	SG85	SG85
Evap	Main	-	Φ7, (2R*10S+1R*4S)*825.5mm, (H1.3+H1.3), Hydrophilic, 4by4	Φ7, (2R*10S+1R*4S)*825.5mm, (H1.3+H1.3), Hydrophilic, 4by4	Φ7, 2R*10S*660mm, H1.3, Hydrophilic, 2by2	Φ7, 2R*10S*660mm, H1.3, Hydrophilic, 2by2
	Sub	-	Φ7, (2R*6S+1R*4S)*825.5mm, (H1.3+H1.3), Hydrophilic : (S3-6)	Φ7, (2R*6S+1R*4S)*825.5mm, (H1.3+H1.3), Hydrophilic : (S3-7)	Φ7, 2R*5(6)S*660mm, H1.3, Hydrophilic : (S2-1)	Φ7, 2R*5(6)S*660mm, H1.3, Hydrophilic : (S2-1)
Cond	Main	-	Φ7W, 2R*28S*906.8mm, Corrugate1.5, Hydrophilic, 4by4by1	Φ7W, 2R*28S*906.8mm, Corrugate1.5, Hydrophilic, 4by4by1	Φ7W, 2R*24S*620.5mm, Corrugate1.5, Hydrophilic, 2by2	Φ7W, 2R*24S*620.5mm, Corrugate1.5, Hydrophilic, 2by2
	Sub	-	-	-	-	-
Comp	Model	-	KTN150D42UFR	KTN150D42UFR	UB1TC5102FJ6	UB1TC5102FJ6
	OLP	-	-	-	-	-
Motor In	Code	-	DB31-00637A	DB31-00637A	DB31-00636A	DB31-00636A
	Name	-	-	-	-	-
Motor Out	Code	-	DB31-00706A	DB31-00658K	DB31-00706A	DB31-00706A
	Name	-	-	-	-	-
Expansion	Φ * L	-	T01 Φ1.4 [04]	T01 Φ1.4 [04]	T01 Φ1.3 [54]	T01 Φ1.3 [54]
Refrigerant	type	-	R32	R32	R32	R32
	charge	g	1300 g	1300 g	700 g	700 g
SVC Valve	Liquid / Gas	-	Φ6.35/Φ12.7	Φ6.35/Φ15.88	Φ6.35/Φ9.52	Φ6.35/Φ9.52
Tube	Dis. / Suc.	-	Φ9.52/Φ12.7	Φ9.52/Φ12.7	Φ7.94/Φ9.52	Φ7.94/Φ9.52
Drain hose	D * L	mm	20*550	20*550	20*550	20*550
4-WAY V/V		-	-	-	-	-
Power Supply		V/Hz/Φ	220-240/50/1	220-240/50/1	220-240/50/1	220-240/50/1
Climate Class		-	T1	T1	T1	T1
Noise	IDU UT,T	dB	48 / 58 dB↓	51 / 62 dB↓	42 / 56 dB↓	44 / 58 dB↓
	ODU	dB	57 / 65 dB↓	60 / 68 dB↓	51 / 63 dB↓	53 / 63 dB↓
Net Size (W*D*H)	IDU	mm	1055*299*215	1055*299*215	889*299*215	889*299*215
	ODU	mm	880*638*310	880*638*310	710*540*220	710*540*220
Weight	IDU	kg	12.5	12.5	9.9	9.9
	ODU	kg	36.8	38.6	24	24
Operation range	Cooling	IDU	16 ~ 32 °C	16 ~ 32 °C	16 ~ 32 °C	16 ~ 32 °C
		ODU	-10 ~ 46 °C	-10 ~ 46 °C	-10 ~ 46 °C	-10 ~ 46 °C
	Heating	IDU	27 °C or less	27 °C or less	27 °C or less	27 °C or less
		ODU	-15 ~ 24 °C	-15 ~ 24 °C	-15 ~ 24 °C	-15 ~ 24 °C

2-2 Product specification

Model			AR60F18C1AW/EU	AR60F24C1AW/EU	AR70F07C1AB/EU	AR70F07C1AW/EU
Rating	Mode	Unit	Wall-mounted	Wall-mounted	Wall-mounted	Wall-mounted
Capacity	T1 Cool	W	5000	6500	2000	2000
	T3 Cool	W	-	-	-	-
	Heat	W	6000	7400	2200	2200
Power Input	T1 Cool	W	1390	1950	430	430
	T3 Cool	W	-	-	-	-
	Heat	W	1610	2200	460	460
Current	T1 Cool	A	6.4	8.8	2.3	2.3
	T3 Cool	A	-	-	-	-
	Heat	A	7.8	9.8	2.3	2.3
Efficiency	EER	W/W	3.60	3.33	4.65	4.65
	-	-	-	-	-	-
	COP	W/W	3.73	3.36	4.78	4.78
Dehumidifying		l/hr.	2.5	2.5	2.5	2.5
Platform	IDU	-	QF3	QF3	QF2	QF2
	ODU	-	Q-480	Q-480	N-SI	N-SI
Evap	Main	-	Φ7, (2R*10S+1R*4S)*825.5mm, (H1.3+H1.3), Hydrophilic, 4by4	Φ7, (2R*10S+1R*4S)*825.5mm, (H1.3+H1.3), Hydrophilic, 4by4	Φ7, 2R*10S*660mm, H1.3, Hydrophilic, 2by2	Φ7, 2R*10S*660mm, H1.3, Hydrophilic, 2by2
	Sub	-	Φ7, (2R*6S+1R*4S)*825.5mm, (H1.3+H1.3), Hydrophilic : (S3-6)	Φ7, (2R*6S+1R*4S)*825.5mm, (H1.3+H1.3), Hydrophilic : (S3-7)	Φ7, 2R*5(6)S*660mm, H1.3, Hydrophilic : (S2-1)	Φ7, 2R*5(6)S*660mm, H1.3, Hydrophilic : (S2-1)
Cond	Main	-	Φ7W, 2R*28S*906.8mm, Corrugate1.5, Hydrophilic, 4by4by1	Φ7W, 2R*28S*906.8mm, Corrugate1.5, Hydrophilic, 4by4by1	Φ7W, 2R*24S*850/825mm, Corrugate1.5, Hydrophilic, 4by4by2	Φ7W, 2R*24S*850/825mm, Corrugate1.5, Hydrophilic, 4by4by2
	Sub	-	-	-	-	-
Comp	Model	-	KTN150D42UFR	KTN150D42UFR	KTN130D42UFR	KTN130D42UFR
	OLP	-	-	-	-	-
Motor In	Code	-	DB31-00637A	DB31-00637A	DB31-00636A	DB31-00636A
	Name	-	-	-	-	-
Motor Out	Code	-	DB31-00706A	DB31-00658K	DB31-00706A	DB31-00706A
	Name	-	-	-	-	-
Expansion	Φ * L	-	T01 Φ1.4 [04]	T01 Φ1.4 [04]	T01 Φ1.3 [54]	T01 Φ1.3 [54]
Refrigerant	type	-	R32	R32	R32	R32
	charge	g	1300 g	1300 g	950 g	950 g
SVC Valve	Liquid / Gas	-	Φ6.35/Φ12.7	Φ6.35/Φ15.88	Φ6.35/Φ9.52	Φ6.35/Φ9.52
Tube	Dis. / Suc.	-	Φ9.52/Φ12.7	Φ9.52/Φ12.7	Φ9.52/Φ12.7	Φ9.52/Φ12.7
Drain hose	D * L	mm	20*550	20*550	20*550	20*550
4-WAY V/V		-	-	-	-	-
Power Supply		V/Hz/Φ	220-240/50/1	220-240/50/1	220-240/50/1	220-240/50/1
Climate Class		-	T1	T1	T1	T1
Noise	IDU UT,T	dB	48 / 58 dB↓	51 / 62 dB↓	42 / 56 dB↓	42 / 56 dB↓
	ODU	dB	57 / 65 dB↓	60 / 68 dB↓	51 / 59 dB↓	51 / 59 dB↓
Net Size (W*D*H)	IDU	mm	1055*299*215	1055*299*215	889*299*215	889*299*215
	ODU	mm	880*638*310	880*638*310	790*548*285	790*548*285
Weight	IDU	kg	12.3	12.3	9.9	9.9
	ODU	kg	36.8	38.6	30.7	30.7
Operation range	Cooling	IDU	16 ~ 32 °C	16 ~ 32 °C	16 ~ 32 °C	16 ~ 32 °C
		ODU	-10 ~ 46 °C	-10 ~ 46 °C	-10 ~ 46 °C	-10 ~ 46 °C
	Heating	IDU	27 °C or less	27 °C or less	27 °C or less	27 °C or less
		ODU	-15 ~ 24 °C	-15 ~ 24 °C	-15 ~ 24 °C	-15 ~ 24 °C

2-2 Product specification

Model			AR70F09C1AB/EU	AR70F09C1AW/EU	AR70F09CAAW/EU	AR70F12C1AB/EU
Rating	Mode	Unit	Wall-mounted	Wall-mounted	Wall-mounted	Wall-mounted
Capacity	T1 Cool	W	2500	2500	2500	3500
	T3 Cool	W	-	-	-	-
	Heat	W	3200	3200	3200	4000
Power Input	T1 Cool	W	570	570	535	910
	T3 Cool	W	-	-	-	-
	Heat	W	760	760	675	1070
Current	T1 Cool	A	3	3	2.8	4.1
	T3 Cool	A	-	-	-	-
	Heat	A	3.4	3.4	3.2	4.7
Efficiency	EER	W/W	4.39	4.39	4.67	3.85
	-	-	-	-	-	-
	COP	W/W	4.21	4.21	4.74	3.74
Dehumidifying		l/hr.	2.5	2.5	2.5	2.5
Platform	IDU	-	QF2	QF2	QF2	QF2
	ODU	-	N-SI	N-SI	N-SI	N-SI
Evap	Main	-	Φ7, 2R*10S*660mm, H1.3, Hydrophilic, 2by2	Φ7, 2R*10S*660mm, H1.3, Hydrophilic, 2by2	Φ7, (2R*10S+1R*4S)*660mm, (H1.3+H1.3), Hydrophilic, 1by2	Φ7, 2R*10S*660mm, H1.3, Hydrophilic, 2by2
	Sub	-	Φ7, 2R*5(6)S*660mm, H1.3, Hydrophilic : (S2-1)	Φ7, 2R*5(6)S*660mm, H1.3, Hydrophilic : (S2-1)	Φ7, (2R*6S+1R*4S)*660mm, (H1.3+H1.3), Hydrophilic : (S2-3)	Φ7, 2R*5(6)S*660mm, H1.3, Hydrophilic : (S2-1)
Cond	Main	-	Φ7W, 2R*24S*850/825mm, Corrugate1.5, Hydrophilic, 4by4by2	Φ7W, 2R*24S*850/825mm, Corrugate1.5, Hydrophilic, 4by4by2	Φ7W, 2R*24S*850/825mm, Corrugate1.5, Hydrophilic, 4by4by2	Φ7W, 2R*24S*850/825mm, Corrugate1.5, Hydrophilic, 4by4by2
	Sub	-	-	-	-	-
Comp	Model	-	KTN130D42UFR	KTN130D42UFR	KTN130D42UFR	KTN130D42UFR
	OLP	-	-	-	-	-
Motor In	Code	-	DB31-00636A	DB31-00636A	DB31-00636A	DB31-00636A
	Name	-	-	-	-	-
Motor Out	Code	-	DB31-00706A	DB31-00706A	DB31-00706A	DB31-00706A
	Name	-	-	-	-	-
Expansion	Φ * L	-	T01 Φ1.3 [54]	T01 Φ1.3 [54]	T01 Φ1.3 [54]	T01 Φ1.3 [54]
Refrigerant	type	-	R32	R32	R32	R32
	charge	g	950 g	950 g	965 g	950 g
SVC Valve	Liquid / Gas	-	Φ6.35/Φ9.52	Φ6.35/Φ9.52	Φ6.35/Φ9.52	Φ6.35/Φ9.52
Tube	Dis. / Suc.	-	Φ9.52/Φ12.7	Φ9.52/Φ12.7	Φ9.52/Φ12.7	Φ9.52/Φ12.7
Drain hose	D * L	mm	20*550	20*550	20*550	20*550
4-WAY V/V		-	-	-	-	-
Power Supply		V/Hz/Φ	220-240/50/1	220-240/50/1	220-240/50/1	220-240/50/1
Climate Class		-	T1	T1	T1	T1
Noise	IDU UT,T	dB	42 / 56 dB↓	42 / 56 dB↓	42 / 56 dB↓	44 / 58 dB↓
	ODU	dB	51 / 59 dB↓	51 / 59 dB↓	51 / 59 dB↓	53 / 62 dB↓
Net Size (W*D*H)	IDU	mm	889*299*215	889*299*215	889*299*215	889*299*215
	ODU	mm	790*548*285	790*548*285	790*548*285	790*548*285
Weight	IDU	kg	9.9	9.9	10.5	9.9
	ODU	kg	30.7	30.7	30.7	30.7
Operation range	Cooling	IDU	16 ~ 32 °C	16 ~ 32 °C	16 ~ 32 °C	16 ~ 32 °C
		ODU	-10 ~ 46 °C	-10 ~ 46 °C	-10 ~ 46 °C	-10 ~ 46 °C
	Heating	IDU	27 °C or less	27 °C or less	27 °C or less	27 °C or less
		ODU	-15 ~ 24 °C	-15 ~ 24 °C	-15 ~ 24 °C	-15 ~ 24 °C









2-2 Product specification









Model			AR70F12C1AW/EU	AR70F12CAAW/EU	AR70F15C1AW/EU	AR70F18C1AW/EU
Rating	Mode	Unit	Wall-mounted	Wall-mounted	Wall-mounted	Wall-mounted
Capacity	T1 Cool	W	3500	3500	4300	5000
	T3 Cool	W	-	-	-	-
	Heat	W	4000	4000	4700	6000
Power Input	T1 Cool	W	910	860	1180	1390
	T3 Cool	W	-	-	-	-
	Heat	W	1070	940	1260	1610
Current	T1 Cool	A	4.1	4.1	5.2	6.4
	T3 Cool	A	-	-	-	-
	Heat	A	4.7	4.4	5.6	7.8
Efficiency	EER	W/W	3.85	4.07	3.64	3.60
	-	-	-	-	-	-
	COP	W/W	3.74	4.26	3.73	3.73
Dehumidifying		l/hr.	2.5	2.5	2.5	2.5
Platform	IDU	-	QF2	QF2	QF2	QF3
	ODU	-	N-SI	N-SI	N-SI	Q-480
Evap	Main	-	Φ7, 2R*10S*660mm, H1.3, Hydrophilic, 2by2	Φ7, (2R*10S+1R*4S)*660mm, (H1.3+H1.3), Hydrophilic, 1by2	Φ7, 2R*10S*660mm, H1.3, Hydrophilic, 2by2	Φ7, (2R*10S+1R*4S)*825.5mm, (H1.3+H1.3), Hydrophilic, 4by4
	Sub	-	Φ7, 2R*5(6)S*660mm, H1.3, Hydrophilic : (S2-1)	Φ7, (2R*6S+1R*4S)*660mm, (H1.3+H1.3), Hydrophilic : (S2-3)	Φ7, 2R*5(6)S*660mm, H1.3, Hydrophilic : (S2-1)	Φ7, (2R*6S+1R*4S)*825.5mm, (H1.3+H1.3), Hydrophilic : (S3-6)
Cond	Main	-	Φ7W, 2R*24S*850/825mm, Corrugate1.5, Hydrophilic, 4by4by2	Φ7W, 2R*24S*850/825mm, Corrugate1.5, Hydrophilic, 4by4by2	Φ7W, 2R*24S*850/825mm, Corrugate1.5, Hydrophilic, 4by4by2	Φ7W, 2R*28S*906.8mm, Corrugate1.5, Hydrophilic, 4by4by1
	Sub	-	-	-	-	-
Comp	Model	-	KTN130D42UFR	KTN130D42UFR	KTN130D42UFR	KTN150D42UFR
	OLP	-	-	-	-	-
Motor In	Code	-	DB31-00636A	DB31-00636A	DB31-00636A	DB31-00637A
	Name	-	-	-	-	-
Motor Out	Code	-	DB31-00706A	DB31-00706A	DB31-00706A	DB31-00706A
	Name	-	-	-	-	-
Expansion	Φ * L	-	T01 Φ1.3 [54]	T01 Φ1.3 [54]	T01 Φ1.3 [54]	T01 Φ1.4 [04]
Refrigerant	type	-	R32	R32	R32	R32
	charge	g	950 g	965 g	950 g	1300 g
SVC Valve	Liquid / Gas	-	Φ6.35/Φ9.52	Φ6.35/Φ9.52	Φ6.35/Φ9.52	Φ6.35/Φ12.7
Tube	Dis. / Suc.	-	Φ9.52/Φ12.7	Φ9.52/Φ12.7	Φ9.52/Φ12.7	Φ9.52/Φ12.7
Drain hose	D * L	mm	20*550	20*550	20*550	20*550
4-WAY V/V		-	-	-	-	-
Power Supply		V/Hz/Φ	220-240/50/1	220-240/50/1	220-240/50/1	220-240/50/1
Climate Class		-	T1	T1	T1	T1
Noise	IDU UT,T	dB	44 / 58 dB↓	44 / 58 dB↓	48 / 58 dB↓	48 / 58 dB↓
	ODU	dB	53 / 62 dB↓	53 / 62 dB↓	57 / 65 dB↓	57 / 65 dB↓
Net Size (W*D*H)	IDU	mm	889*299*215	889*299*215	889*299*215	1055*299*215
	ODU	mm	790*548*285	790*548*285	790*548*285	880*638*310
Weight	IDU	kg	9.9	10.5	9.9	12.3
	ODU	kg	30.7	30.7	30.7	36.8
Operation range	Cooling	IDU	16 ~ 32 °C	16 ~ 32 °C	16 ~ 32 °C	16 ~ 32 °C
		ODU	-10 ~ 46 °C	-10 ~ 46 °C	-10 ~ 46 °C	-10 ~ 46 °C
	Heating	IDU	27 °C or less	27 °C or less	27 °C or less	27 °C or less
		ODU	-15 ~ 24 °C	-15 ~ 24 °C	-15 ~ 24 °C	-15 ~ 24 °C

2-2 Product specification

Model			AR70F24C1AW/EU
Rating	Mode	Unit	Wall-mounted
Capacity	T1 Cool	W	6500
	T3 Cool	W	-
	Heat	W	7400
Power Input	T1 Cool	W	1950
	T3 Cool	W	-
	Heat	W	2200
Current	T1 Cool	A	8.8
	T3 Cool	A	-
	Heat	A	9.8
Efficiency	EER	W/W	3.33
	-	-	-
	COP	W/W	3.36
Dehumidifying		l/hr.	2.5
Platform	IDU	-	QF3
	ODU	-	Q-480
Evap	Main	-	Φ7, (2R*10S+1R*4S)*825.5mm, (H1.3+H1.3), Hydrophilic, 4by4
	Sub	-	Φ7, (2R*6S+1R*4S)*825.5mm, (H1.3+H1.3), Hydrophilic : (S3-7)
Cond	Main	-	Φ7W, 2R*28S*906.8mm, Corrugate1.5, Hydrophilic, 4by4by1
	Sub	-	-
Comp	Model	-	KTN150D42UFR
	OLP	-	-
Motor In	Code	-	DB31-00637A
	Name	-	-
Motor Out	Code	-	DB31-00658K
	Name	-	-
Expansion	Φ * L	-	T01 Φ1.4 [04]
Refrigerant	type	-	R32
	charge	g	1300 g
SVC Valve	Liquid / Gas	-	Φ6.35/Φ15.88
Tube	Dis. / Suc.	-	Φ9.52/Φ12.7
Drain hose	D * L	mm	20*550
4-WAY V/V		-	-
Power Supply		V/Hz/Φ	220-240/50/1
Climate Class		-	T1
Noise	IDU UT,T	dB	51 / 62 dB↓
	ODU	dB	60 / 68 dB↓
Net Size (W*D*H)	IDU	mm	1055*299*215
	ODU	mm	880*638*310
Weight	IDU	kg	12.3
	ODU	kg	38.6
Operation range	Cooling	IDU	16 ~ 32 °C
		ODU	-10 ~ 46 °C
	Heating	IDU	27 °C or less
		ODU	-15 ~ 24 °C



2-3 The comparative specification of product

Model		DEVELOPMENT MODEL			
		AR50F07C1AH/EU	AR50F09C1AH/EU	AR50F12C1AH/EU	AR50F15C1AH/EU
Design	Indoor Unit				
	Outdoor Unit				
Net Weight	Indoor Unit	9.1	9.1	9.1	9.1
	Outdoor Unit	24	24	24.4	30.7
Net Dimension	Indoor Unit	820*299*215	820*299*215	820*299*215	820*299*215
	Outdoor Unit	710*540*220	710*540*220	710*540*220	790*548*285
Noise	Indoor Unit	41 / 54 dB↓	41 / 54 dB↓	43 / 56 dB↓	48 / 58 dB↓
	Outdoor Unit	51 / 60 dB↓	51 / 63 dB↓	53 / 63 dB↓	57 / 65 dB↓
Air Purifying System		EASY CLEAN FILTER	EASY CLEAN FILTER	EASY CLEAN FILTER	EASY CLEAN FILTER
Indoor Display		88 SEG	88 SEG	88 SEG	88 SEG



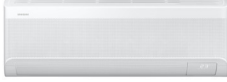

Model		DEVELOPMENT MODEL			
		AR50F18C1AH/EU	AR50F24C1AH/EU	AR60F09C1AW/EU	AR60F12C1AW/EU
Design	Indoor Unit				
	Outdoor Unit				
Net Weight	Indoor Unit	12.5	12.5	9.9	9.9
	Outdoor Unit	36.8	38.6	24	24
Net Dimension	Indoor Unit	1055*299*215	1055*299*215	889*299*215	889*299*215
	Outdoor Unit	880*638*310	880*638*310	710*540*220	710*540*220
Noise	Indoor Unit	48 / 58 dB↓	51 / 62 dB↓	42 / 56 dB↓	44 / 58 dB↓
	Outdoor Unit	57 / 65 dB↓	60 / 68 dB↓	51 / 63 dB↓	53 / 63 dB↓
Air Purifying System		EASY CLEAN FILTER	EASY CLEAN FILTER	EASY CLEAN FILTER	EASY CLEAN FILTER
Indoor Display		88 SEG	88 SEG	88 SEG	88 SEG

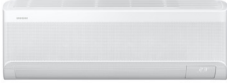
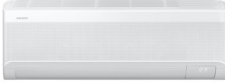
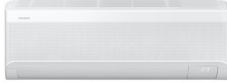
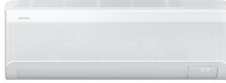

2-3 The comparative specification of product

Model		DEVELOPMENT MODEL			
		AR60F18C1AW/EU	AR60F24C1AW/EU	AR70F07C1AB/EU	AR70F07C1AW/EU
Design	Indoor Unit				
	Outdoor Unit				
Net Weight	Indoor Unit	12.3	12.3	9.9	9.9
	Outdoor Unit	36.8	38.6	30.7	30.7
Net Dimension	Indoor Unit	1055*299*215	1055*299*215	889*299*215	889*299*215
	Outdoor Unit	880*638*310	880*638*310	790*548*285	790*548*285
Noise	Indoor Unit	48 / 58 dB↓	51 / 62 dB↓	42 / 56 dB↓	42 / 56 dB↓
	Outdoor Unit	57 / 65 dB↓	60 / 68 dB↓	51 / 59 dB↓	51 / 59 dB↓
Air Purifying System		EASY CLEAN FILTER	EASY CLEAN FILTER	EASY CLEAN FILTER	EASY CLEAN FILTER
Indoor Display		88 SEG	88 SEG	88 SEG	88 SEG





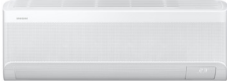

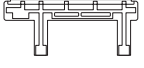

Model		DEVELOPMENT MODEL			
		AR70F09C1AB/EU	AR70F09C1AW/EU	AR70F09CAAW/EU	AR70F12C1AB/EU
Design	Indoor Unit				
	Outdoor Unit				
Net Weight	Indoor Unit	9.9	9.9	10.5	9.9
	Outdoor Unit	30.7	30.7	30.7	30.7
Net Dimension	Indoor Unit	889*299*215	889*299*215	889*299*215	889*299*215
	Outdoor Unit	790*548*285	790*548*285	790*548*285	790*548*285
Noise	Indoor Unit	42 / 56 dB↓	42 / 56 dB↓	42 / 56 dB↓	44 / 58 dB↓
	Outdoor Unit	51 / 59 dB↓	51 / 59 dB↓	51 / 59 dB↓	53 / 62 dB↓
Air Purifying System		EASY CLEAN FILTER	EASY CLEAN FILTER	EASY CLEAN FILTER	EASY CLEAN FILTER
Indoor Display		88 SEG	88 SEG	88 SEG	88 SEG

2-3 The comparative specification of product

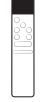
Model		DEVELOPMENT MODEL			
		AR70F12C1AW/EU	AR70F12CAAW/EU	AR70F15C1AW/EU	AR70F18C1AW/EU
Design	Indoor Unit				
	Outdoor Unit				
Net Weight	Indoor Unit	9.9	10.5	9.9	12.3
	Outdoor Unit	30.7	30.7	30.7	36.8
Net Dimension	Indoor Unit	889*299*215	889*299*215	889*299*215	1055*299*215
	Outdoor Unit	790*548*285	790*548*285	790*548*285	880*638*310
Noise	Indoor Unit	44 / 58 dB↓	44 / 58 dB↓	48 / 58 dB↓	48 / 58 dB↓
	Outdoor Unit	53 / 62 dB↓	53 / 62 dB↓	57 / 65 dB↓	57 / 65 dB↓
Air Purifying System		EASY CLEAN FILTER	EASY CLEAN FILTER	EASY CLEAN FILTER	EASY CLEAN FILTER
Indoor Display		88 SEG	88 SEG	88 SEG	88 SEG

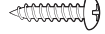
Model		DEVELOPMENT MODEL
		AR70F24C1AW/EU
Design	Indoor Unit	
	Outdoor Unit	
Net Weight	Indoor Unit	12.3
	Outdoor Unit	38.6
Net Dimension	Indoor Unit	1055*299*215
	Outdoor Unit	880*638*310
Noise	Indoor Unit	51 / 62 dB↓
	Outdoor Unit	60 / 68 dB↓
Air Purifying System		EASY CLEAN FILTER
Indoor Display		88 SEG

2-4 Accessory and Option Specifications

Item	Descriptions	Code No.	Q'ty	Remark
	ASSY HANGER	DB90-11453A (Q1, Q2)	1	Indoor unit case
		DB90-11454A (Q3)	1	
	ASSY WIRELESS REMOCON	DB96-25924T	1	
	HOLDER REMOCON	DB61-08068A	1	
	M4 x 12 Tapped Screws	6002-000213	2	
	USER MANUAL	DB68-13181A DB68-13303A DB68-13304A	1	
	INSTALLATION MANUAL	DB68-13182C	1	
	Rubber Leg	DB67-01533A	4	Outdoor unit case
	Drain plug	DB67-20011A	1	

3. Alignment and Adjustments

3-1 Test Mode

◆ How to Approach Test Mode

You can approach the test mode by pressing the on/off switch of indoor unit for 5 seconds.

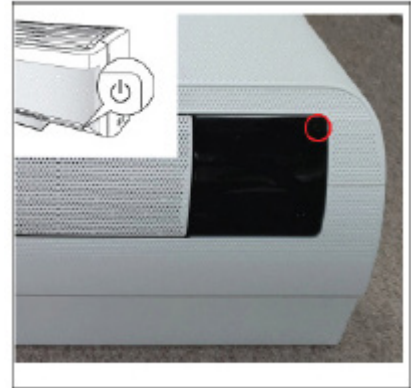

◆ Test mode operation option

After installing the air conditioner, test mode checks if each of the functions below operate normally or not by operating the test mode.

- When an Error occurs, test mode will display the error.
- **Cool Mode:** during Cool Mode testing, the compressor will run continuously. (Cool Mode testing overrides the antifreeze protection of the indoor unit)
- **Up-down louver :** Up-down swing mode
- **Indoor Fan :** Turbo



Note

- Because the test mode will operate the Cool Mode by force, check after completing the installation if each of the functions operate normally and as a last step you need to turn off the power of the air conditioner.

3-2 Display Error and Check Method

3-2-1 Indoor Display Error and Check Method

ERROR MODE	TYPE	DESCRIPTION
7-SEG	INDOOR/ OUTDOOR	
C101, C102	INDOOR	Communication error
C108		Set address error
C121		Indoor unit room (return air) temperature sensor is open/short
C122, C123		INDOOR MID, INDOOR IN EVA-TH sensor error
C140		Dust sensor error
C142		Humidity error
C143		Motion sensor error
C154		Fan error(indoor)
C161		Mixed operation error
C163		Option error
C187		K1 filter feed back error
C665		Drain pump error

Note

If the set doesn't work (No power), check the thermal fuse of terminal block OPEN or SHORT with Multimeter.

* Measure the thermal fuse housing PIN#1~2 : OPEN(disconnection)-> defective product

3-2 Display Error and Check Method

3-2-2 Outdoor Display Error and Check Method

7-SEG	ERROR MODE			DESCRIPTION			
	YEL	GRN	RED				
-	○	○	○	POWER OFF / VDD NG			
-	●	●	●	POWER ON RESET(1SEC)			
-	○	◐	●	NORMAL OPERATION			
C201	○	○	●	COMMUNICATION ERROR (INDOOR - OUTDOOR MATCHING)			
C202				COMMUNICATION ERROR (INDOOR - OUTDOOR)			
C108	○	●	●	SETTING ADDRESS DUPLICATE ERROR			
C464	○	○	◐	IPM OVER CURRENT(O.C) ERROR → COMP IPM OVER CURRENT(O.C) ERROR			
C461	○	◐	○	COMP STARTING ERROR			
C470	○	●	○	EEPROM DATA ERROR(NO DATA)			
C466	○	●	◐	DC-LINK VOLTAGE UNDER/OVER ERROR → COMP DC-LINK VOLTAGE UNDER/OVER ERROR			
C484				PFC OVER LOAD ERROR			
C483				OVER VOLTAGE PROTECTION ERROR			
C486				FAN DC-LINK VOLTAGE UNDER/OVER ERROR			
C221				◐	○	◐	OUT-TH(OUT DOOR TEMP) SENSOR ERROR
C416	◐	○	●	DIS-TH(DISCHARGE TEMP) OVER ERROR			
C251	◐	◐	○	DIS-TH(DISCHARGE TEMP) SENSOR ERROR			
C468	◐	●	●	CURRENT SENSOR ERROR → COMP CURRENT SENSOR ERROR			
C474				HEATSINK SENSOR ERROR → COMP HEATSINK SENSOR ERROR			
C485				INPUT CURRENT SENSOR ERROR			
C465				COMP V_LIMIT / I_LLIMIT ERROR			
C500	◐	●	○	HEATSINK OVER TEMP ERROR → COMP HEATSINK OVER TEMP ERROR			
C381	◐	●	◐	COMP CONTROLLER PCB OVERHEAT			
C231				◐	●	◐	CON-TH(COND TEMP) SENSOR ERROR
C205				◐	●	●	TIME OUT COMM.(MAIN MICOM - COMP MICOM and FAN MICOM)
C206				◐	●	●	TIME OUT COMM.(MAIN MICOM - COMP MICOM or FAN MICOM)
C383				FAN CONTROLLER PCB OVERHEAT			
C478				FAN IPM OVER CURRENT(O.C) ERROR			
C489				FAN VLIMIT / I_LLIMIT ERROR			
C446				FAN STARTING ERROR			
C447				FAN WIRE MISSING ERROR			
C455				FAN HEATSINK OVER TEMP ERROR			
C493				FAN CURRENT SENSOR ERROR			
C499				FAN HEATSINK SENSOR ERROR			
C590	●	○	◐	EEPROM DATA ERROR(COMP MICOM - MAIN MICOM)			
C594	●	○	◐	EEPROM DATA ERROR(FAN MICOM - MAIN MICOM)			
C467	●	○	●	COMP WIRE MISSING ERROR			
C440	●	◐	○	PROHIBIT OPERATION CONDITION ERROR(H/P)			
C441				PROHIBIT OPERATION CONDITION ERROR(C/O)			
C507				COMP DOWN DUE TO HIGH PRESSURE SWITCH OPEN ERROR			
C469	●	◐	◐	DC-LINK VOLTAGE SENSOR ERROR → COMP DC-LINK VOLTAGE SENSOR ERROR			
C488				AC INPUT VOLTAGE SENSOR ERROR			
C496				FAN DC-LINK VOLTAGE SENSOR ERROR			
C462				AC INPUT I_LIMIT TRIP ERROR			
C554	●	●	◐	GAS SHORTAGE ERROR			
C574				GAS LEAK ERROR			
C422				EEV OR VALVE CLOSE ERROR-SELF DIAGNOSIS			
C404				OVERLOAD PROTECTOIN CONTROL			
-	○	◐	◐	TEST OPERATION AT COOLING MODE			
-	◐	◐	◐	TEST OPERATION AT HEATING MODE			

● : LAMP ON

○ : LAMP OFF

◐ : LAMP BLINK

3-3 Setting Option Setup Method

Example Option code : **13-FC-50-B2-2A-71-E0-07-10-20**

Step 1 Enter Service mode

- 1 To enter Service mode hold the MODE button and press downwards TEMP and FAN simultaneously for 6 seconds
- 2 Wait till the screen gets black or will show SW initialization

Step 2 Enter the Option Setup mode.

1. Connect the remote control by using the USB port (C-Type) at the bottom of the remote control.

2. Press and hold the  and  button simultaneously for 5 seconds.







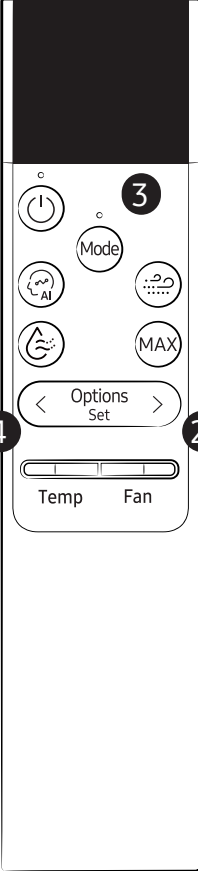
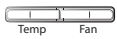
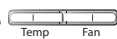

(After connecting the remote control, press the  and  button within 10 seconds.)

3. Make sure the remote control display shown as

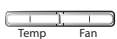
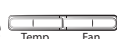

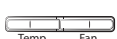
* When setting the option code, press the next button within 5 seconds so that the setting is not interrupted.

Step 3 Enter the Option Setup mode.

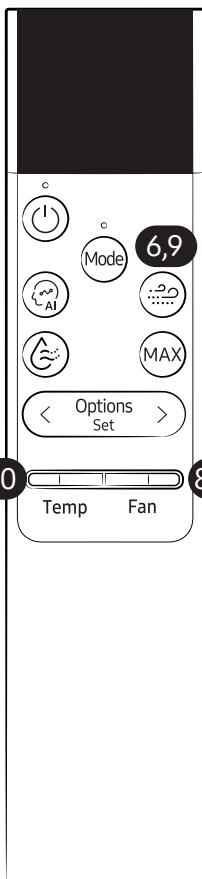

	<p>1 Setting SEG 1</p> <p>Press the  button to set the display panel to 1.</p> <p>Every time you press the  button, the display panel reads 0 → 1 → 2 → 3 → ... 9 → A → B → C → D → E → F repeatedly.</p>	
	<p>2 Setting SEG 2</p> <p>Press the  button to set the display panel to 3.</p> <p>Every time you press the  button, the display panel reads 0 → 1 → 2 → 3 → ... 9 → A → B → C → D → E → F repeatedly.</p>	
	<p>3 Press the  button to set next options.</p>	
	<p>4 Setting SEG 3</p> <p>Press the  button to set the display panel to F.</p> <p>Every time you press the  button, the display panel reads 0 → 1 → 2 → 3 → ... 9 → A → B → C → D → E → F repeatedly.</p>	
	<p>5 Setting SEG 4</p> <p>Press the  button to set the display panel to C.</p> <p>Every time you press the  button, the display panel reads 0 → 1 → 2 → 3 → ... 9 → A → B → C → D → E → F repeatedly.</p>	

Step 3 Enter the Option Setup mode.



6 Press the  button to set next options.

7 Setting SEG 5

Press the  button to set the display panel to 5.
Every time you press the  button, the display panel reads 0 → 1 → 2 → 3 → ... 9 → A → B → C → D → E → F repeatedly.



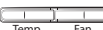

8 Setting SEG 6

Press the  button to set the display panel to 0.
Every time you press the  button, the display panel reads 0 → 1 → 2 → 3 → ... 9 → A → B → C → D → E → F repeatedly.



9 Press the  button to set next options.

10 Setting SEG 7

Press the  button to set the display panel to B.
Every time you press the  button, the display panel reads 0 → 1 → 2 → 3 → ... 9 → A → B → C → D → E → F repeatedly.





11 Setting SEG 8

Press the  button to set the display panel to 2.
Every time you press the  button, the display panel reads 0 → 1 → 2 → 3 → ... 9 → A → B → C → D → E → F repeatedly.



12 Press the  button to set next options.

13 Setting SEG 9

Press the  button to set the display panel to 2.
Every time you press the  button, the display panel reads 0 → 1 → 2 → 3 → ... 9 → A → B → C → D → E → F repeatedly.



14 Setting SEG 10

Press the  button to set the display panel to A.
Every time you press the  button, the display panel reads 0 → 1 → 2 → 3 → ... 9 → A → B → C → D → E → F repeatedly.

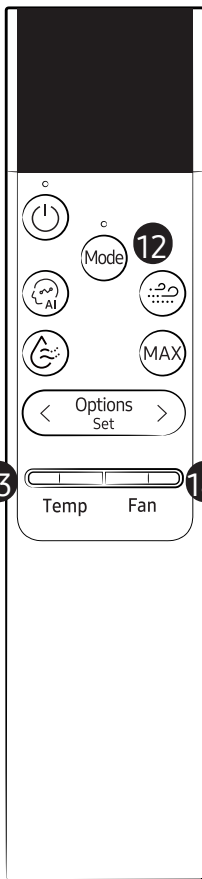

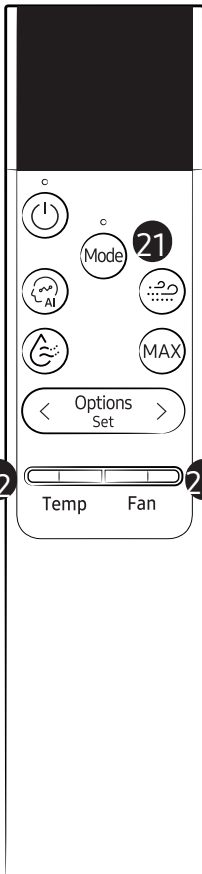
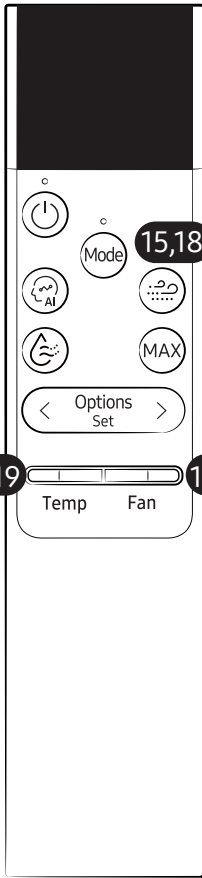

Step 3 Enter the Option Setup mode.



15 Press the  button to set next options.

16 Setting SEG 11

Press the  button to set the display panel to 7.
Every time you press the  button, the display panel reads 0 → 1 → 2 → 3 → ... 9 → A → B → C → D → E → F repeatedly.

17 Setting SEG 12

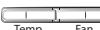

Press the  button to set the display panel to 1.
Every time you press the  button, the display panel reads 0 → 1 → 2 → 3 → ... 9 → A → B → C → D → E → F repeatedly.

18 Press the  button to set next options.

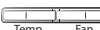
19 Setting SEG 13

Press the  button to set the display panel to E.
Every time you press the  button, the display panel reads 0 → 1 → 2 → 3 → ... 9 → A → B → C → D → E → F repeatedly.

20 Setting SEG 14

Press the  button to set the display panel to 0.
Every time you press the  button, the display panel reads 0 → 1 → 2 → 3 → ... 9 → A → B → C → D → E → F repeatedly.

21 Press the  button to set next options.

22 Setting SEG 15

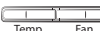
Press the  button to set the display panel to 0.
Every time you press the  button, the display panel reads 0 → 1 → 2 → 3 → ... 9 → A → B → C → D → E → F repeatedly.

23 Setting SEG 16

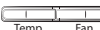
Press the  button to set the display panel to 7.
Every time you press the  button, the display panel reads 0 → 1 → 2 → 3 → ... 9 → A → B → C → D → E → F repeatedly.

71

E0

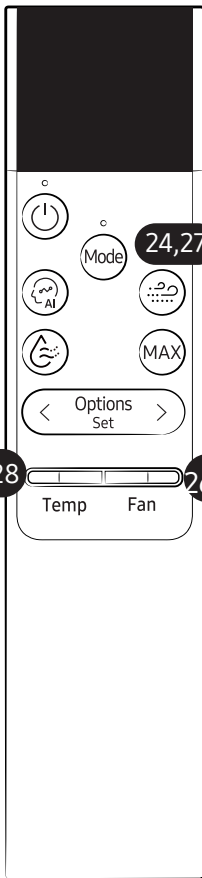

07

Step 3 Enter the Option Setup mode.





24 Press the  button to set next options.

25 Setting SEG 17



Press the  button to set the display panel to 1.
Every time you press the  button, the display panel reads 0 → 1 → 2 → 3 → ... 9 → A → B → C → D → E → F repeatedly.

26 Setting SEG 18

Press the  button to set the display panel to 0.
Every time you press the  button, the display panel reads 0 → 1 → 2 → 3 → ... 9 → A → B → C → D → E → F repeatedly.

27 Press the  button to set next options.

28 Setting SEG 19

Press the  button to set the display panel to 2.
Every time you press the  button, the display panel reads 0 → 1 → 2 → 3 → ... 9 → A → B → C → D → E → F repeatedly.

29 Setting SEG 20

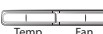
Press the  button to set the display panel to 0.
Every time you press the  button, the display panel reads 0 → 1 → 2 → 3 → ... 9 → A → B → C → D → E → F repeatedly.

10

20



Step 4 Upon completion of the selection, check you made right selections.

Press the  button to set the display part and check the display part.

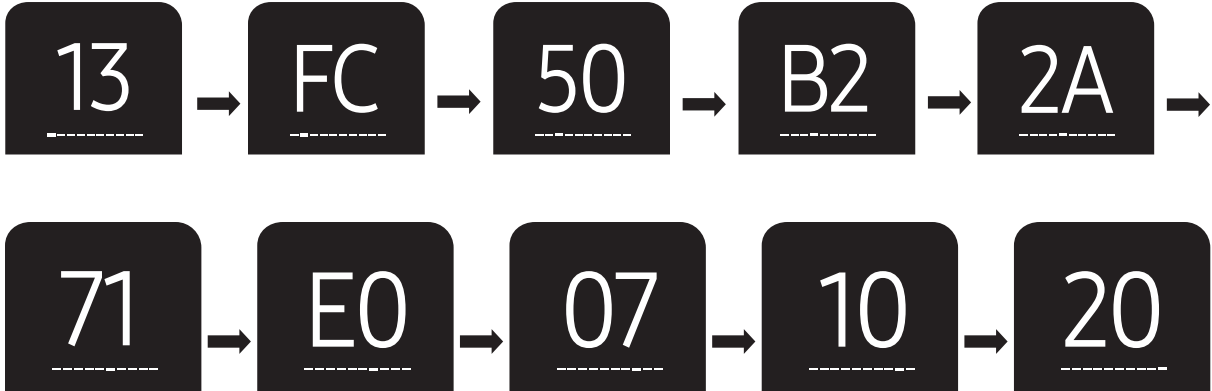
→ The display part shows like below when each time you press the  button.



Step 5 Press the  button.

When pressing the operation  button with the direction of remote control for the sound “Ding” or “Diriring” is heard, then the input of option is completed. (If the sound isn’t heard, try again by pressing the  button.)

Step 6 Press  button after 5 second and check whether the option code is set properly.

Option code :





Model	Option code	
	General	Install
AR50F12C1AH/EU	011205-1744FA-272323-371842	026000-100000-200361-300300
AR50F07C1AH/EU	011205-1744DA-271416-371842	026000-100000-200361-300300
AR50F09C1AH/EU	011205-1744EA-271920-371842	026000-100000-200361-300300
AR60F07C1AW/EU	011A05-17C0DA-271416-371842	024000-100150-200321-300335
AR60F12C1AW/EU	011A05-17C617-272328-371642	024000-100150-200361-300346
AR60F09C1AW/EU	011A05-19C4F7-271920-371642	024000-100150-200361-300346
AR70F12CAAW/EU	011A05-18C4A6-271920-371542	024000-100150-200361-300346
AR70F12C1AB/EU	011A05-18C4C7-272328-371642	024000-100150-200361-300346
AR70F07C1AB/EU	011A05-18C496-271416-371542	024000-100150-200361-300346
AR70F12C1AW/EU	011A05-18C4C7-272328-371642	024000-100150-200361-300346
AR70F07C1AW/EU	011A05-18C496-271416-371542	024000-100150-200361-300346
AR70F07CAAW/EU	011A05-18C0E7-271416-371642	024002-100150-200321-300346
AR70F09CAAW/EU	011A05-19C4F7-271920-371642	024002-100150-200361-300346
AR70F09C1AW/EU	011A05-18C4A6-271920-371542	024000-100150-200361-300346
AR70F09C1AB/EU	011A05-18C4A6-271920-371542	024000-100150-200361-300346
AR70F15C1AW/EU	011A05-15C637-272B2F-371642	024000-100150-200361-300379
AR50F15C1AH/EU	011205-17462A-272B2B-371842	026000-100000-200361-300300
AR70F18C1AW/EU	011A05-15C62B-27323C-372442	024000-100150-200361-300357
AR60F18C1AW/EU	011A05-15C62B-27323C-372442	024000-100150-200361-300357
AR50F18C1AH/EU	011205-15461B-27323C-372442	026000-100000-200361-300300
AR70F24C1AW/EU	011A05-16C65B-27414A-371442	024000-100150-200361-300357
AR60F24C1AW/EU	011A05-16C65B-27414A-371442	024000-100150-200361-300357
AR50F24C1AH/EU	011205-16464B-27414A-371442	026000-100000-200361-300300
AR50F18C1BH/EU	011205-15461B-27323A-372442	026000-100000-200361-300300
AR50F24C1BH/EU	011205-16464B-27414A-371442	026000-100000-200361-300300

4. Disassembly and Reassembly

◆ Necessary Tools

Item	Remark
Crosshead SCREW DRIVER Q'ty 1 ea. To assemble and disassemble the screws	
MONKEY SPANNER Q'ty 1 ea. To assemble and disassemble the fan motor and compressor	
Flat head SCREW DRIVER Q'ty 1 ea. To assemble and disassemble the screws	

4-1. Indoor Unit

NO.	Parts	Procedure	Remark
1	FRONT-PANEL	<p>1) Stop the driving of air conditioner and shut off main power supply.</p> <p>2) Detach PRE FILTER from the PANEL FRONT.</p> <p>3) The COVER PANEL is fixed to body by hooks in center and side area.</p> <p>4) Separate the hook pulling the end of the COVER PANEL as shown in figures.(Watch out for damaging the hooks)</p>	     

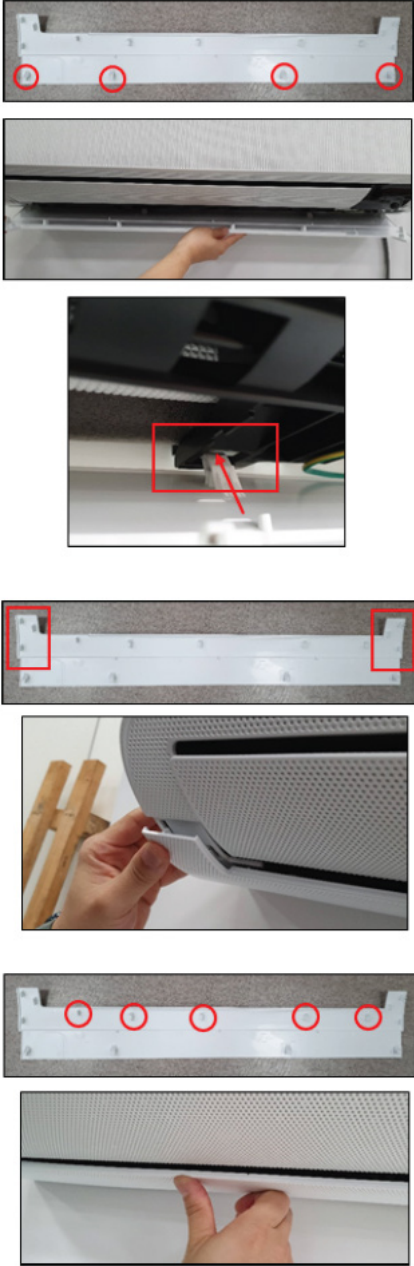

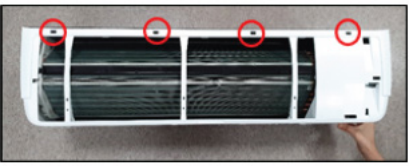
NO.	Parts	Procedure	Remark
1	FRONT-PANEL	<p>⚠ Caution: Be cautious with the assembly of the Cover Panel after the end of service. - Place back the front panel with both hands and please be careful not to damage the piping or drain hose in the process. - Please check if all the panel hooks are in the holes of the main frame before pushing the front panel.</p> <p>⚠ Caution: - To assemble push side hooks - To assemble push all of the 5 center hooks</p>	

NO.	Parts	Procedure	Remark
1	FRONT-PANEL	<p>5) The INLET GRILLE is fixed to body by hooks in the center and side area.</p> <p>6) Separate the hook by pulling end of the INLET GRILLE as shown in figures.(Watch out for the damage of hooks)</p> <p>7) To remove the FRONT PANEL from the main frame, remove 2 screws at the bottom. (use (+) Screw Driver)</p> <p>8) To remove the FRONT PANEL from the main frame, loosen 4 hook structures. When separating the hooks: pull out each ribs near the hooks as shown in figures. (Watch out for damaging the hooks)</p>	      

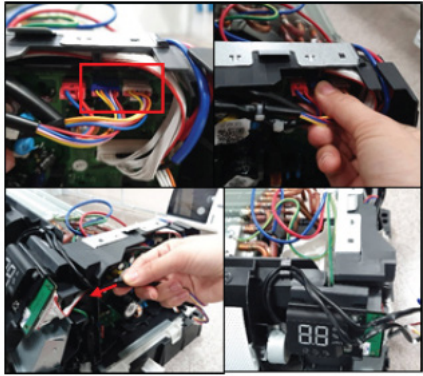
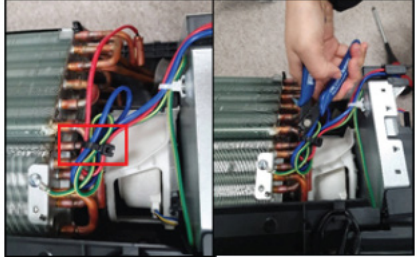

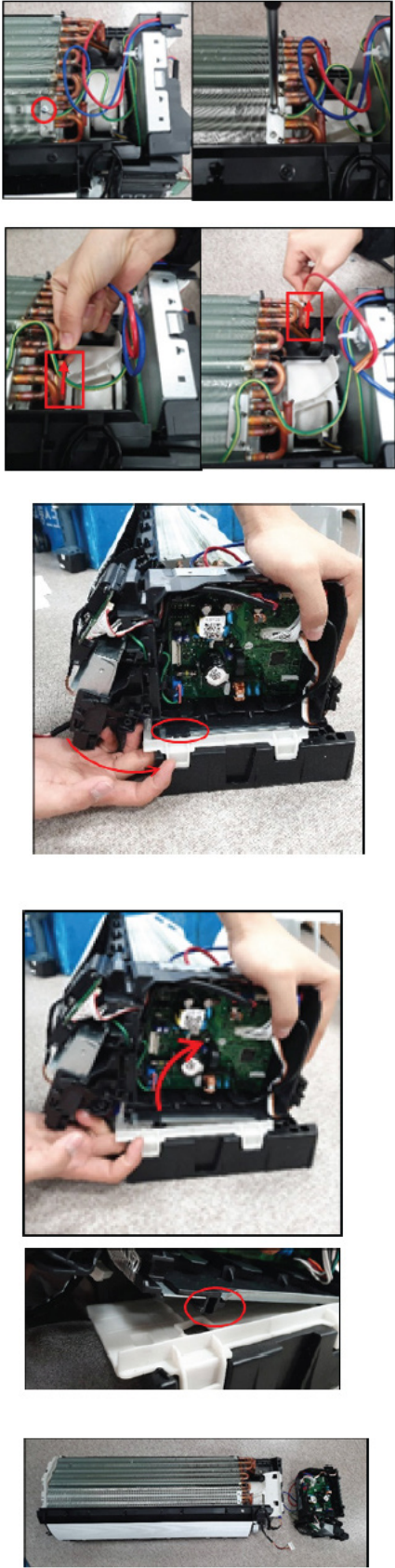

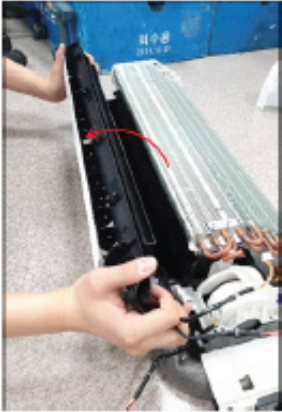
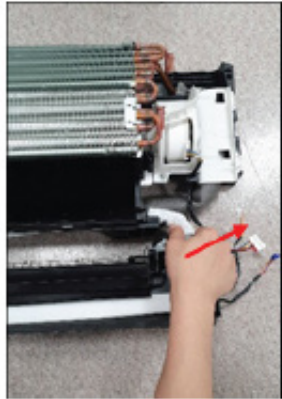
NO.	Parts	Procedure	Remark
1	FRONT PANEL	9) Raise the FRONT PANEL upward as shown in the figure to separate the 3 hooks.	 
2	CONTROL-CASE	<p>10) To open the INDOOR-PBA cover, raise the side flanges of the PLATE-RIGHT at an angle and unlock 2 hooks.</p> <p>11) Separate Fan Motor wire as shown in figures.</p>	   



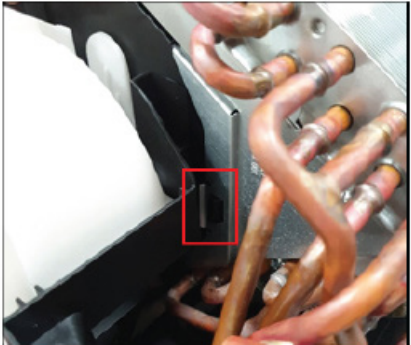

NO.	Parts	Procedure	Remark
2	CONTROL-CASE	<p>⚠ Caution: When you want to unplug the connector, press the connector to unlock</p> <p>12)Separate Blade Motor wire as shown in figures.</p> <p>⚠ Caution: When you want to unplug the connector, press the connector to unlock</p> <p>13)Cut off the Cable Tie that is holding together the wires. (see image)</p>	  

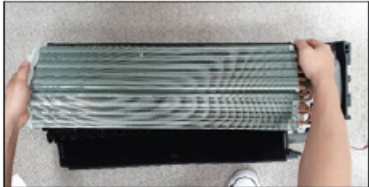
NO.	Parts	Procedure	Remark
2	CONTROL-CASE	<p>14) Unfasten the screw of the Ground wire and take out Temperature wires from ASSY EVAP. (Use (+) Screw Driver.)</p> <p>15) The CONTROL-CASE is fixed to the PIPE HOLDER by a hook at the bottom of the case as shown on the image on the right. (Please loosen remaining connectors before detaching CONTROL-CASE.)</p> <p>⚠ Caution: When you want to unplug the connector, press the connector to unlock</p> <p>16) Push up the hook of the PIPE-HOLDER at bottom and lean on the CONTROL-CASE as shown on the image.</p>	

NO.	Parts	Procedure	Remark
3	DRAIN TRAY	17) To detach the DRAIN TRAY from the main frame, pull the bottom of the DRAIN TRAY towards you as can be seen on the images on the right.	
		18) Pull out the Drain Hose.	  

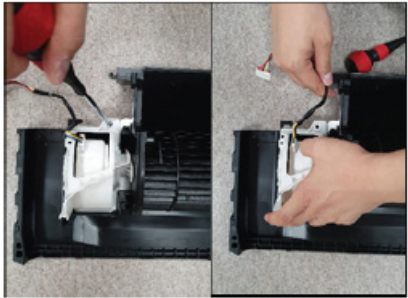
NO.	Parts	Procedure	Remark
4	EVAPORATOR	<p>19) The PIPE HOLDER is fixed to body by 2 hooks as shown in the figure.</p> <p>20) To detach the PIPE-HOLDER from the main frame, loosen the 2 hooks with a screwdriver. When separating the hooks: Use the (-) flat head screw driver and insert the screw driver into the gap of the hooks and slowly separate each hook by pivoting the screw driver towards the motor side.</p> <p>21) Remove the PIPE HOLDER.</p> <p>22) Unfasten the screw of the Fan Motor side. (Use (+) Screw Driver.)</p> <p>23) Unfasten 2 screws of the opposite side of the Fan Motor. (Use (+) Screw Driver.)</p>	    

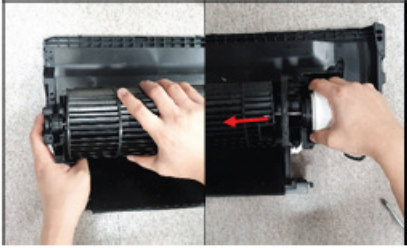
NO.	Parts	Procedure	Remark
4	EVAPORATOR	<p>24) Pull up the EVAPORATOR of the opposite side of the Fan Motor</p> <p>25) loosen the hook of the Fan Motor side.</p> <p>26) Pull up the EVAPORATOR towards to you.</p>	     

NO.	Parts	Procedure	Remark
5	FAN MOTOR & CROSS FAN	<p>27) Unfasten the screw on the COVER Motor. (Use (+) Screw Driver.)</p> <p>28) Unwind the Motor Wire.</p> <p>29) Remove the MOTOR COVER</p>	  
		<p>30) Unfasten the screw of the CROSS FAN a little. (Use (+) Screw Driver.)</p> <p>31) Raise up the CROSS FAN on the left side and pull out from the Motor.</p>	  

4-2. Outdoor Unit (SG85)

AR50F07C1AHXEU
 AR50F09C1AHXEU
 AR50F12C1AHXEU
 AR60F09C1AWXEU
 AR60F12C1AWXEU

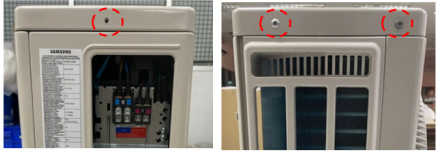
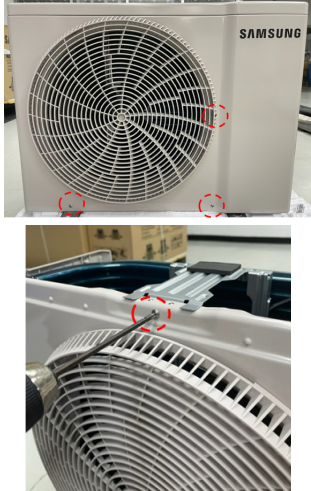
NO.	Parts	Procedure	Remark
1	Common work	1) Loosen each screw and detach the cabinet Top cover.	
		2) Loosen the screws of the front cabinet and detach it.	

NO.	Parts	Procedure	Remark
		<p>3) Loosen the screws on the left bottom side of the outdoor unit</p> <p>4) Loosen the screws on the right hand side of the cabinet and remove the plastic cover</p>	

NO.	Parts	Procedure	Remark
2	Fan & Motor	<p>1) Remove the Flange Nut like the picture on the right side. (Turn clockwise because the screw is left-handed.) (Use Monkey Spanner.)</p> <p>2) Remove the Fan Propeller.</p> <p>3) Loosen the 4 screws to detach the Motor. (Use (+) Screw Driver)</p> <p>4) Disconnect the wire between Ass'y Control Out and Motor.</p>	  
		<p>5) Loosen the bolts and detach the Motor Bracket.</p>	

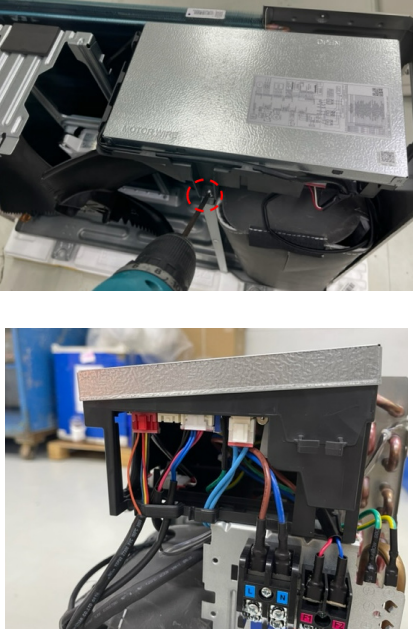
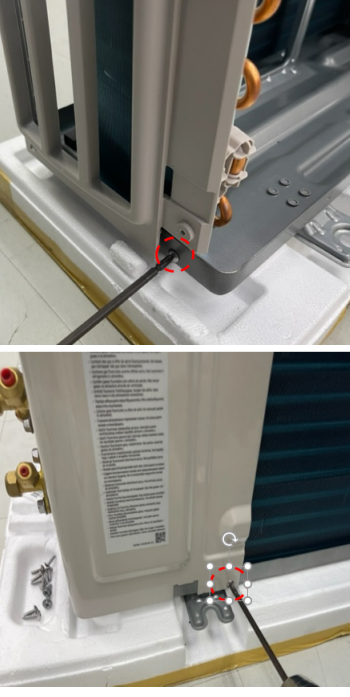
NO.	Parts	Procedure	Remark
3	Assy Control Out	<p>1) To remove the cover of the control box: First pull the motor wire aside to make sure there is sufficient space and then remove the screw. (See image on the right)</p> <p>2) Detach several connectors from the Assy Control Out.</p> <p>3) Detach several connectors from the PCB of Assy Control Out.</p>	
4	Condenser	<p>1) Release the refrigerant at first.</p> <p>2) Loosening screw on both sides.</p> <p>3) Disassemble the pipes in both inlet and outlet with welding torch.</p> <p>4) Detach the Heat Exchanger.</p>	



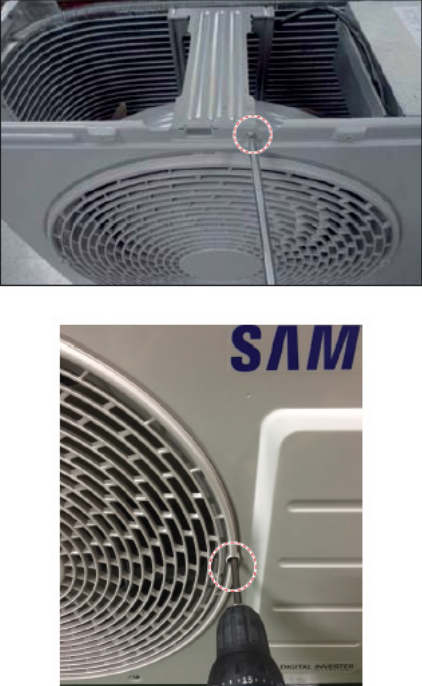

NO.	Parts	Procedure	Remark
5	Compressor	<p>1) Loosen the nut and detach the Compressor Lead Wire. (Use Monkey Spanner.)</p> <p>2) Loosen the bolts at the bottom of Compressor like the picture on the right side. (Use Monkey Spanner.)</p>	

4-3. Outdoor Unit (N-SI)

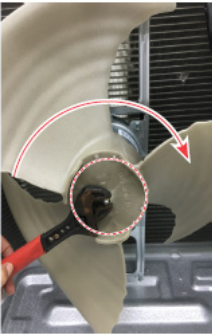

AR50F15C1AHXEU
 AR70F07C1AWXEU
 AR70F07C1AWXEU
 AR70F09C1AWXEU
 AR70F09C1AWXEU
 AR70F09CAAWXEU
 AR70F12C1AWXEU
 AR70F12C1AWXEU
 AR70F12CAAWXEU
 AR70F15C1AWXEU

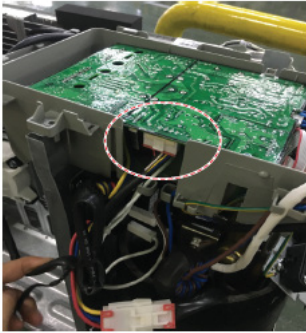
NO.	Parts	Procedure	Remark
1	Common work	1) Loosen the screws and detach the cabinet Top cover.	
		2) Loosen the screws of the front cabinet and detach it.	

NO.	Parts	Procedure	Remark
		<p>3) Remove the condenser protection bar from the 4 holders on the outdoor unit cabinet. * This process is supported by heating models only</p>	
		<p>4) Loosen the screws on the left hand side of the outdoor unit.</p> <p>5) Loosen the screws on the right hand side of the cabinet and remove the plastic cover.</p>	  

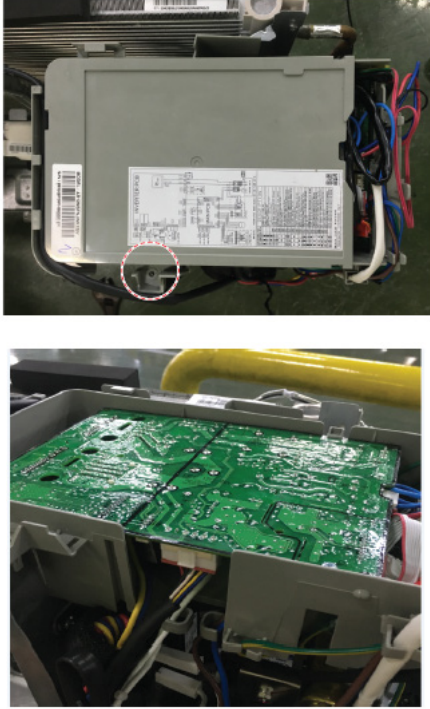
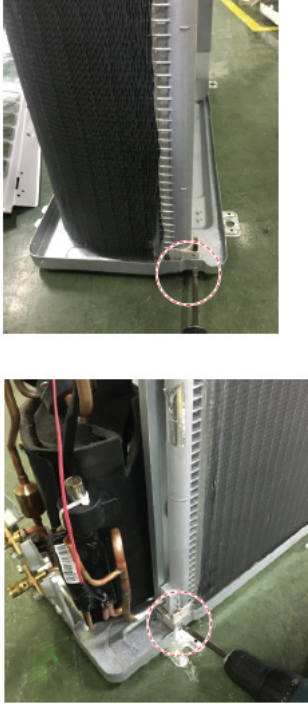
NO.	Parts	Procedure	Remark
2	Fan & Motor	<p>1) Remove the Flange Nut as can be seen on the picture on the right. (Turn clockwise because the screw is left-handed.) (Use Monkey Spanner.)</p> <p>2) Remove the Fan Propeller.</p> <p>3) Loosen the 4 screws to remove the fan motor. (Use Monkey Spanner for remove screw)</p> <p>4) Disconnect the wire between Ass'y Control Out and Motor.</p>	  
		<p>5) Loosen the bolts and detach the Motor Bracket.</p>	

NO.	Parts	Procedure	Remark
3	Assy Control Out	<p>1) To remove the Cover control box : Pull the motor wire to allow sufficient space as shown on the right side and then remove the screw.</p> <p>2) Detach several connectors from the Assy Control Out.</p> <p>3) Detach several connectors from the PCB of Assy Control Out.</p>	
4	Condenser	<p>1) Release the refrigerant at first.</p> <p>2) Loosening screw on both sides.</p> <p>3) Disassemble the pipes in both inlet and outlet with welding torch.</p> <p>4) Detach the Heat Exchanger.</p>	

NO.	Parts	Procedure	Remark
5	Compressor	<p>1) Loosen the nut and detach the Compressor Lead Wire. (Use Monkey Spanner.)</p> <p>2) Loosen the bolts at the bottom of Compressor like the picture on the right side. (Use Monkey Spanner.)</p>	 

4-3. Outdoor Unit (Q-480)

AR50F18C1AHXEU / AR50F24C1AHXEU / AR60F18C1AWXEU
 AR60F24C1AWXEU / AR70F18C1AWXEU / AR70F24C1AWXEU

NO.	Parts	Procedure	Remark
1	COMMON WORK	<p>1) Loosen the screws on the right hand side of the cabinet and remove the plastic cover.</p> <p>2) Loosen the screws and remove the cabinet top cover.</p> <p>3) Loosen the screws on the right hand side of the cabinet.</p> <p>4) Loosen the screws on the right bottom side of the outdoor unit.</p>	

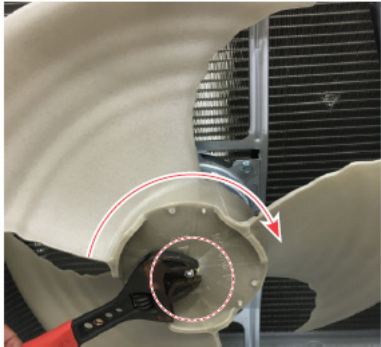
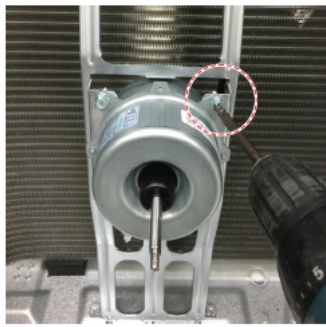
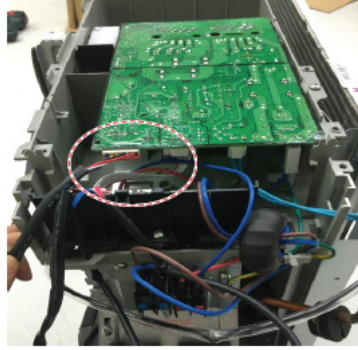
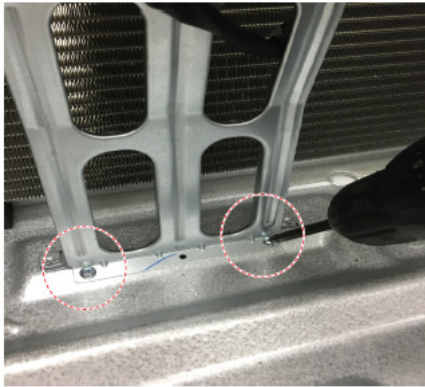
NO.	Parts	Procedure	Remark
2	Fan & Motor	<p>1) Remove the Flange Nut as can be seen on the picture on the right. (Turn clockwise because the screw is left-handed.) (Use Monkey Spanner.)</p> <p>2) Remove the Fan Propeller.</p> <p>3) Loosen the 4 screws to detach the Motor. (Use (+) Screw Driver)</p> <p>4) Disconnect the wire between Assy Control Out and Motor.</p> <p>5) Loosen the bolts and detach the Motor Bracket.</p>	   

NO.	Parts	Procedure	Remark
3	Assy Control Out	<p>1) To remove the cover of the control box : First pull the motor wire aside to make sure there is sufficient space and then remove the screw. (See image on the right)</p> <p>2) Detach several connectors from the Assy Control Out.</p> <p>3) Detach several connectors from the PCB of Assy Control Out.</p>	 
4	Condenser	<p>1) Release the refrigerant at first.</p> <p>2) Loosening screw on both sides.</p> <p>3) Disassemble the pipes in both inlet and outlet with welding torch.</p> <p>4) Detach the Heat Exchanger.</p>	 

5. ASSY CONTROL

5-1 ASSY KIT INDOOR CODE DB92-05830A, D, K, M

Model	Assy Kit Indoor
AR50F07C1AHNEU	DB92-05830A
AR50F09C1AHNEU	DB92-05830A
AR50F12C1AHNEU	DB92-05830A
AR50F15C1AHNEU	DB92-05830A
AR50F18C1AHNEU	DB92-05830A
AR50F24C1AHNEU	DB92-05830A
AR60F07C1AWNEU	DB92-05830D
AR60F09C1AWNEU	DB92-05830D
AR60F12C1AWNEU	DB92-05830D
AR60F18C1AWNEU	DB92-05830D
AR60F24C1AWNEU	DB92-05830D
AR70F07C1ABNEU	DB92-05830M
AR70F07C1AWNEU	DB92-05830D
AR70F07CAAWNEU	DB92-05830K
AR70F09C1ABNEU	DB92-05830M
AR70F09C1AWNEU	DB92-05830D
AR70F09CAAWNEU	DB92-05830K
AR70F12C1ABNEU	DB92-05830M
AR70F12C1AWNEU	DB92-05830D
AR70F12CAAWNEU	DB92-05830K
AR70F15C1AWNEU	DB92-05830D
AR70F18C1AWNEU	DB92-05830D
AR70F24C1AWNEU	DB92-05830D

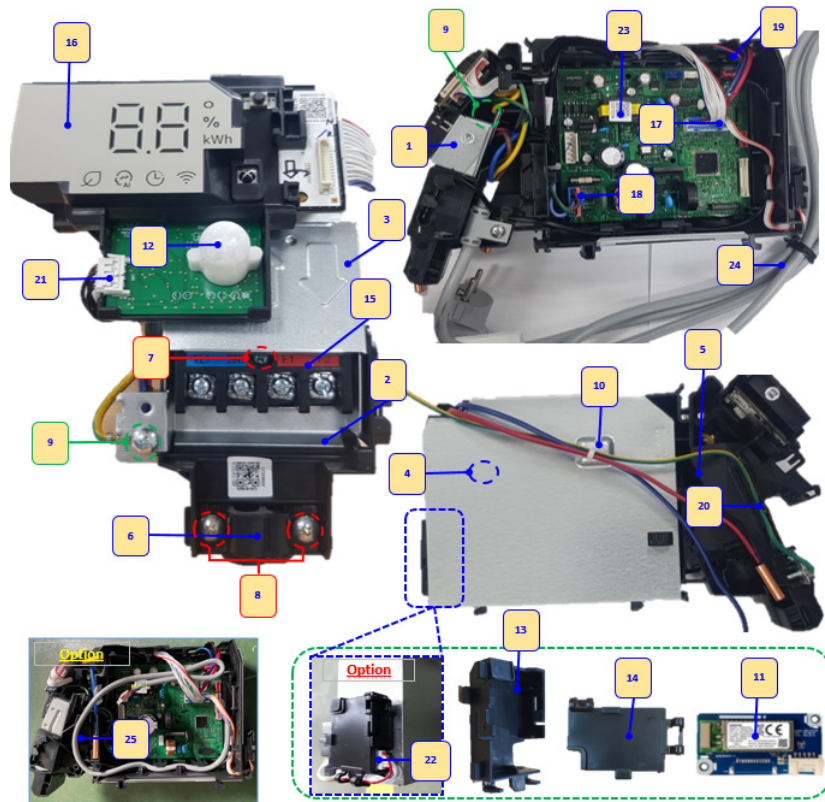

No	NAME	CODE	A	D	K	M	Unit
1	PLATE CONTROL-SUB	DB61-07427B	1	1	1	1	EA
2	PLATE CONTROL-LOW	DB61-07428B	1	1	1	1	EA
3	PLATE CONTROL-UP	DB61-07429C	1	1	1	1	EA
4	PLATE CONTROL-LF	DB61-07431A	1	1	1	1	EA
5	CASE CONTROL-IN	DB61-07432D	1	1	1	1	EA
6	HOLDER-WIRE	DB61-05871A	1	1	1	1	EA
7	SCREW-TAPPING	6002-001163	1	1	1	1	EA
8	SCREW-TAPPING	6002-000213	2	2	2	2	EA
9	SCREW-TAPPING	6006-001170	2	2	2	2	EA
10	CABLE TIE	6501-001075	1	1	1	1	EA
11	W-LAN MODULE (External)	4709-003290	0	0	1	0	EA
12	SENSOR PHOTO (MDS)	DB32-00270B	0	0	1	0	EA
13	CASE PCB (External Wifi)	DB61-07464A	0	0	1	0	EA
14	COVER PCB (External Wifi)	DB63-04265A	0	0	1	0	EA
15	TERMINAL BLOCK	DB37-00033A	1	1	1	1	EA
17	ASSY PCB DISPLAY	DB92-05040V	0	0	1	0	EA
18	ASSY PCB DISPLAY	DB92-05834A	0	0	0	1	EA
19	ASSY PCB DISPLAY	DB92-05834B	1	1	0	0	EA
17	SENSOR TEMP	DB32-00277A	1	0	0	0	EA
17	SENSOR HUMIDITY	DB32-00272A	0	1	1	1	EA
18	ASSY CONNECTOR WIRE-POWER	DB93-17169A	1	1	1	1	EA
19	ASSY CONNECTOR WIRE-COMM	DB93-17055B	1	1	1	1	EA
20	ASSY CONNECTOR WIRE-EARTH (EVA)	DB93-14245D	1	1	1	1	EA
21	ASSY CONNECTOR WIRE-DC SIGNAL (MDS)	DB93-17170A	0	0	1	0	EA
22	ASSY CONNECTOR WIRE	DB93-17190A	0	0	1	0	EA
23	ASSY PCB MAIN-IN	DB92-05822A	1	1	1	1	EA
25	ASSY CONNECTOR WIRE-DC SIGNAL	DB93-17178A	1	1	1	1	EA

5-2 ASSY KIT OUTDOOR CODE DB92-05824A

AR50F07C1AHXEU
 AR50F09C1AHXEU
 AR50F12C1AHXEU
 AR60F09C1AWXEU
 AR60F12C1AWXEU

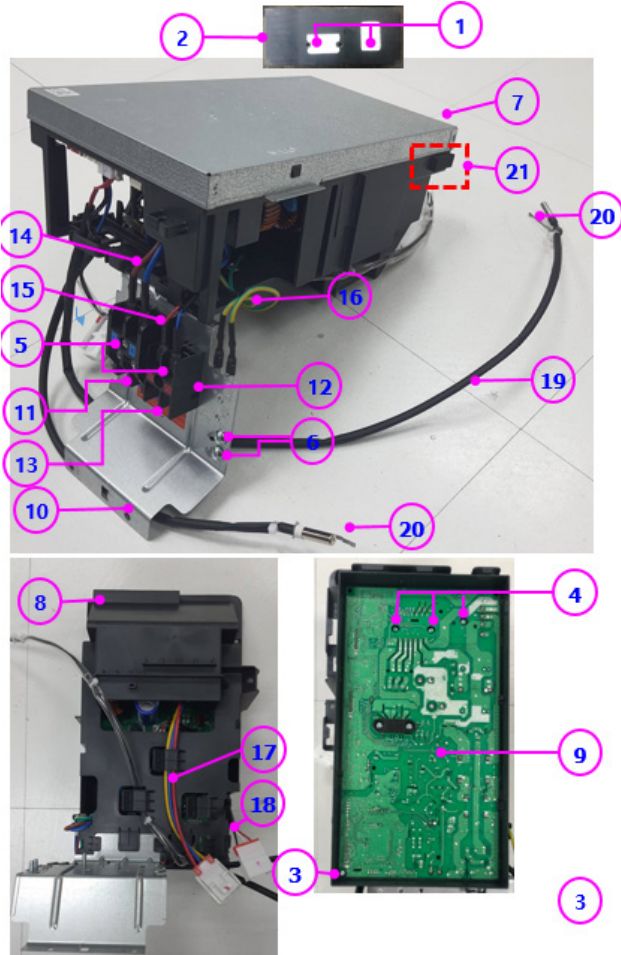

No	NAME	CODE	Q'ty	unit
1	GREASE-SILICON	0205-000178	0.002	Kg
2	HEAT SINK	DB62-13720A	1	EA
3	SCREW-TAPPING	6002-000630	1	EA
4	SCREW-MACHINE	DB91-00306A	3	EA
5	SCREW-TAPPING	6002-000555	2	EA
6	SCREW-TAPTYPE	6006-001170	2	EA
7	COVER CONTROL-OUT	DB63-04643A	1	EA
8	CASE CONTROL-OUT	DB61-08334A	1	EA
9	ASSY PCB INVERTER	DB92-05826A	1	EA
10	PLATE CONTROL	DB61-08331A	1	EA
11	TERMINAL BLOCK	DB37-00036A	1	EA
12	TERMINAL BLOCK	DB65-00274A	1	EA
13	LABEL INSTRUCTION	DB98-34030A	1	EA
14	ASSY CONNECTOR WIRE-POWER	DB93-18070A	1	EA
15	ASSY CONNECTOR WIRE-COMM	DB93-16402A	1	EA
16	ASSY CONNECTOR WIRE-EARTH	DB93-18077A	2	EA
17	ASSY CONNECTOR WIRE-COMP	DB93-09497B	1	EA
18	ASSY CONNECTOR WIRE-MOTOR	DB93-18071A	1	EA
19	SENSOR-TEMP	DB32-00257A	1	EA
20	SPRING ETC-SENSOR	DB81-00635A	2	EA
21	SEAL CONTROL	DB62-13730A	1	EA

5-3 ASSY KIT OUTDOOR CODE DB92-05824D

AR50F15C1AHXEU
 AR70F07C1AWXEU
 AR70F07C1AWXEU
 AR70F09C1AWXEU
 AR70F09C1AWXEU
 AR70F09CAAWXEU
 AR70F12C1AWXEU
 AR70F12C1AWXEU
 AR70F12CAAWXEU
 AR70F15C1AWXEU

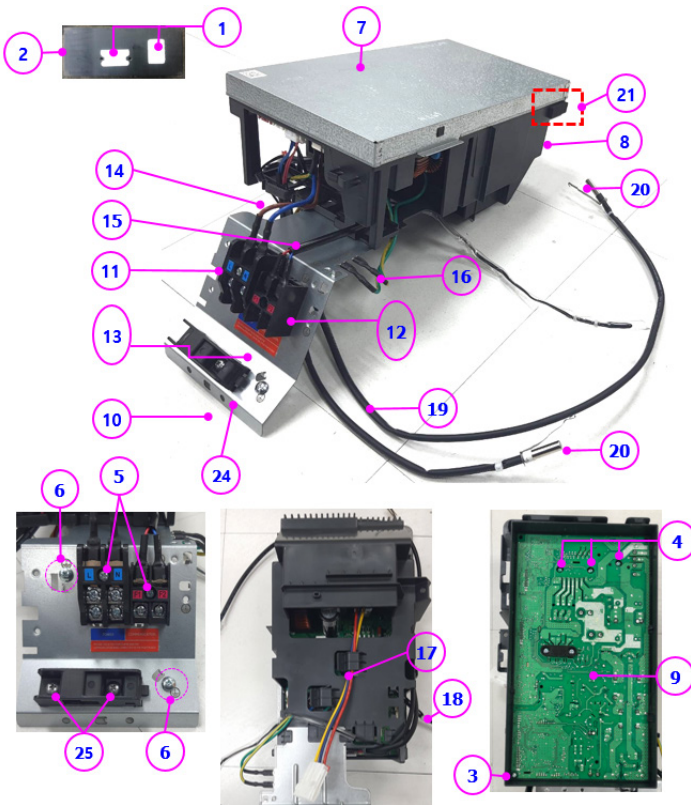

No	NAME	CODE	Q'ty	unit
1	GREASE-SILICON	0205-000178	0.002	Kg
2	HEAT SINK	DB62-13720A	1	EA
3	SCREW-TAPPING	6002-000630	1	EA
4	SCREW-MACHINE	DB91-00306A	3	EA
5	SCREW-TAPPING	6002-000555	2	EA
6	SCREW-TAPTYPE	6006-001170	2	EA
7	COVER CONTROL-OUT	DB63-04643A	1	EA
8	CASE CONTROL-OUT	DB61-08334A	1	EA
9	ASSY PCB INVERTER	DB92-05826A	1	EA
10	PLATE CONTROL	DB61-08369A	1	EA
11	TERMINAL BLOCK	DB37-00036A	1	EA
12	TERMINAL BLOCK	DB65-00274A	1	EA
13	LABEL INSTRUCTION	DB98-34030A	1	EA
14	ASSY CONNECTOR WIRE-POWER	DB93-18070A	1	EA
15	ASSY CONNECTOR WIRE-COMM	DB93-16402A	1	EA
16	ASSY CONNECTOR WIRE-EARTH	DB93-18077A	2	EA
17	ASSY CONNECTOR WIRE-COMP	DB93-09497B	1	EA
18	ASSY CONNECTOR WIRE-MOTOR	DB93-18071A	1	EA
19	SENSOR-TEMP	DB32-00257A	1	EA
20	SPRING ETC-SENSOR	DB81-00635A	2	EA
21	SEAL CONTROL	DB62-13730A	1	EA
24	HOLDER WIRE	DB61-08329A	1	EA
25	SCREW-TAPPING	6002-000481	2	EA

5-4 ASSY KIT OUTDOOR CODE DB92-05824L

AR50F18C1AHXEU

AR60F18C1AWXEU

AR70F18C1AWXEU

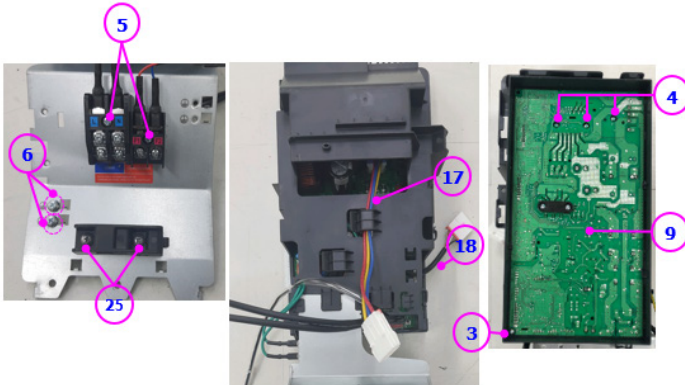
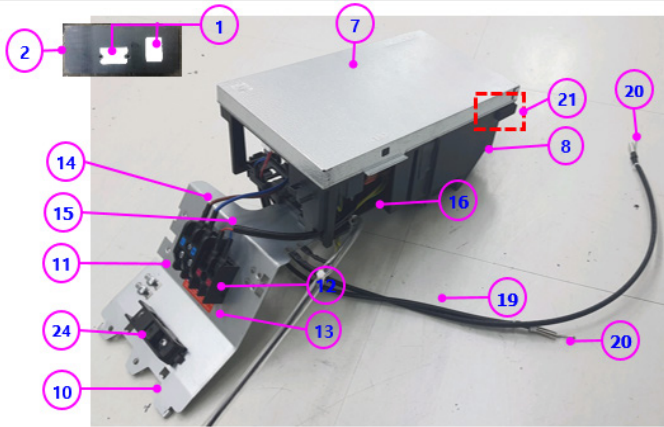

No	NAME	CODE	Q'ty	unit
1	GREASE-SILICON	0205-000178	0.002	Kg
2	HEAT SINK	DB62-13720A	1	EA
3	SCREW-TAPPING	6002-000630	1	EA
4	SCREW-MACHINE	DB91-00306A	3	EA
5	SCREW-TAPPING	6002-000555	2	EA
6	SCREW-TATYPE	6006-001170	2	EA
7	COVER CONTROL-OUT	DB63-04643A	1	EA
8	CASE CONTROL-OUT	DB61-08334A	1	EA
9	ASSY PCB INVERTER	DB92-05826A	1	EA
10	PLATE CONTROL	DB61-08367A	1	EA
11	TERMINAL BLOCK	DB37-00036A	1	EA
12	TERMINAL BLOCK	DB65-00274A	1	EA
13	LABEL INSTRUCTION	DB98-34030A	1	EA
14	ASSY CONNECTOR WIRE-POWER	DB93-18070A	1	EA
15	ASSY CONNECTOR WIRE-COMM	DB93-16402A	1	EA
16	ASSY CONNECTOR WIRE-EARTH	DB93-18077A	2	EA
17	ASSY CONNECTOR WIRE-COMP	DB93-09497B	1	EA
18	ASSY CONNECTOR WIRE-MOTOR	DB93-18071A	1	EA
19	SENSOR-TEMP	DB32-00257A	1	EA
20	SPRING ETC-SENSOR	DB81-00635A	2	EA
21	SEAL CONTROL	DB62-13730A	1	EA
24	HOLDER WIRE	DB61-08329A	1	EA
25	SCREW-TAPPING	6002-000481	2	EA

5-5 ASSY KIT OUTDOOR CODE DB92-05845A

AR50F24C1AHXEU

AR60F24C1AWXEU

AR70F24C1AWXEU

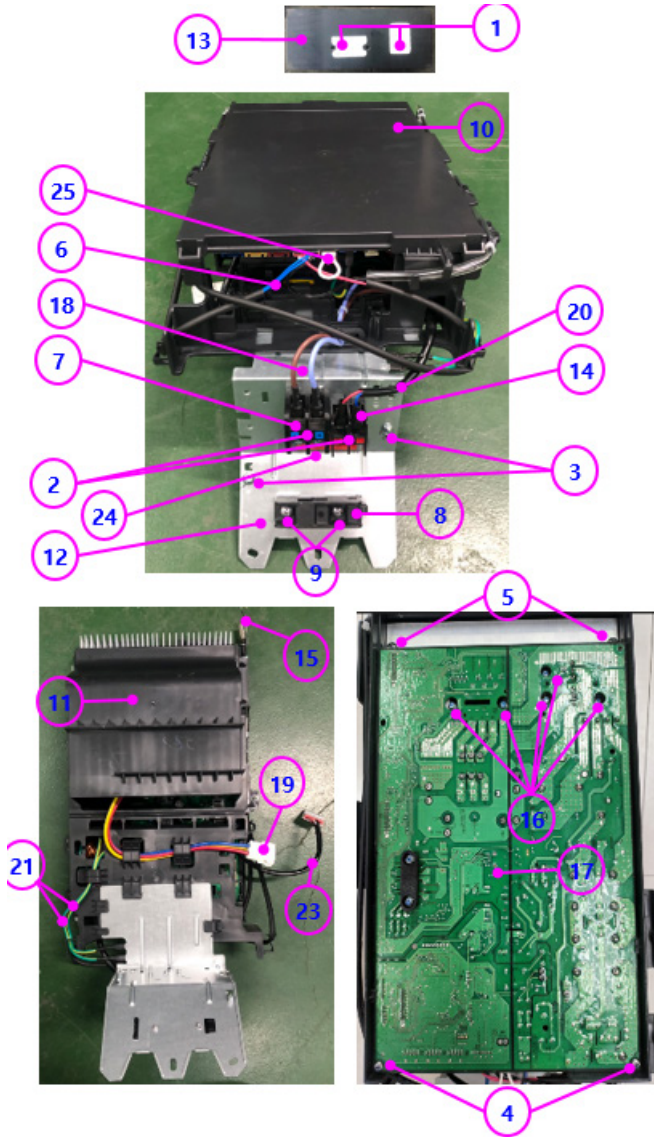

No	NAME	CODE	Q'ty	unit
1	GREASE-SILICON	0205-000178	0.002	Kg
2	SCREW-MACHINE	6002-000555	2	EA
3	SCREW-TAPPING	6006-001170	2	EA
4	SCREW	6002-000536	2	EA
5	SCREW	6002-001306	2	EA
6	SENSOR TEMP	DB32-00257A	1	EA
7	TERMINAL BLOCK	DB37-00036A	1	EA
8	HOLDER WIRE	DB61-08329A	1	EA
9	SCREW-TAPPING	6002-000481	2	EA
10	CASE CONTROL-UP	DB63-04654A	1	EA
11	CASE CONTROL-OUT	DB61-08365A	1	EA
12	PLATE CONTROL	DB61-08368A	1	EA
13	HEAT SINK	DB62-13757A	1	EA
14	TERMINAL BLOCK	DB65-00274A	1	EA
15	SPRING ETC-SENSOR	DB81-00635A	2	EA
16	SCREW-MACHINE	DB91-00306A	5	EA
17	ASSY PCB INVERTER	DB92-05844A	1	EA
18	ASSY CONNECTOR WIRE	DB93-09495E	1	EA
19	ASSY CONNECTOR WIRE-COMP	DB93-10905E	1	EA
20	ASSY CONNECTOR WIRE-COMM	DB93-16402A	1	EA
21	ASSY CONNECTOR WIRE-EARTH WIRE	DB93-18077A	2	EA
23	ASSY CONNECTOR WIRE-MOTOR	DB93-18071A	1	EA
24	LABEL INSTRUCTION	DB98-34030A	1	EA
25	ASSY CONNECTOR WIRE-HIGH PRESSURE POWER	DB93-17517A	1	EA

6. Wiring Diagram

6-1 Indoor Unit

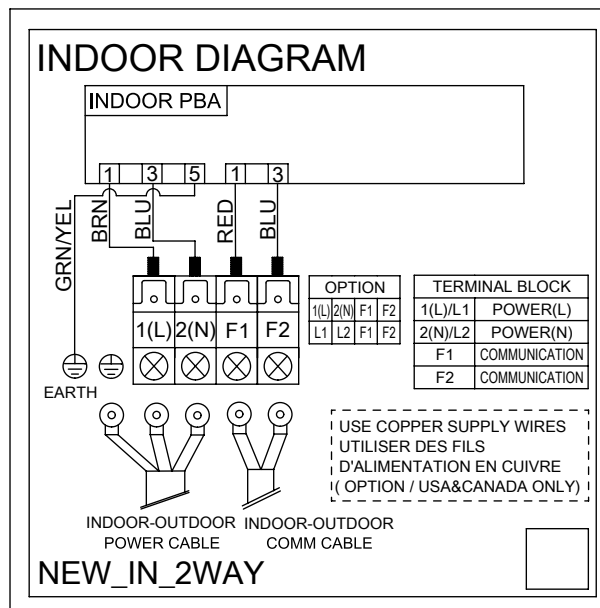

7. PCB Diagram

7-1 Indoor Main PCB CODE DB92-05822A

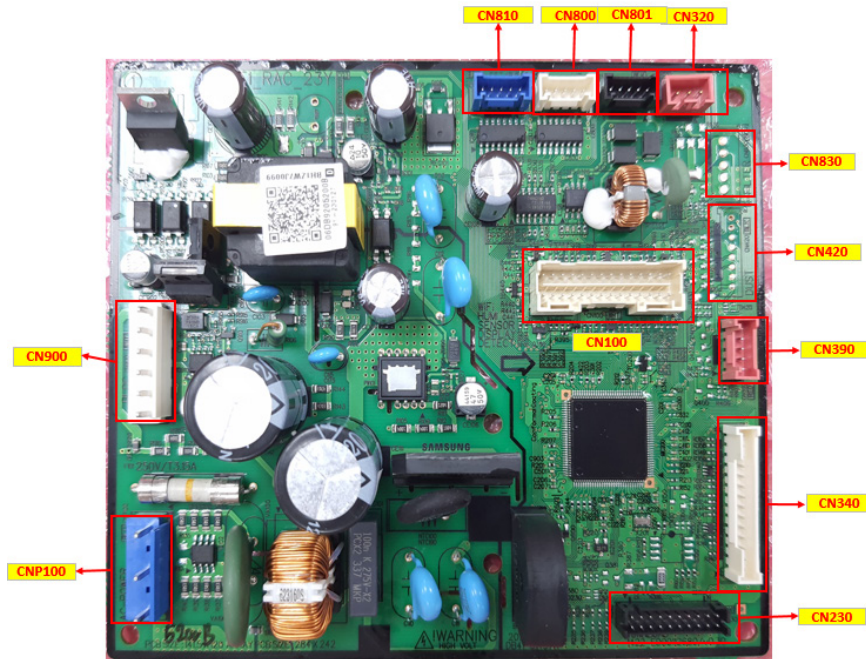

CN810 : STEP MOTOR (LEFT-RIGHT)			CN800 : STEP MOTOR(UP-DOWN) 1			CN801 : STEP MOTOR(UP-DOWN) 2		
#1: 12VDC	#1: 12VDC	#1: 12VDC	#2: MOTOR SIGNAL 1	#2: MOTOR SIGNAL 1	#2: MOTOR SIGNAL 1	#3: MOTOR SIGNAL 2	#3: MOTOR SIGNAL 2	#3: MOTOR SIGNAL 2
#2: MOTOR SIGNAL 1	#3: MOTOR SIGNAL 2	#4: MOTOR SIGNAL 3	#3: MOTOR SIGNAL 2	#4: MOTOR SIGNAL 3	#4: MOTOR SIGNAL 3	#5: MOTOR SIGNAL 4	#5: MOTOR SIGNAL 4	#5: MOTOR SIGNAL 4
#3: MOTOR SIGNAL 2	#4: MOTOR SIGNAL 3	#5: MOTOR SIGNAL 4	#4: MOTOR SIGNAL 3	#5: MOTOR SIGNAL 4				
#4: MOTOR SIGNAL 3								
#5: MOTOR SIGNAL 4								
CNP100 : AC POWER			CN900 : BLDC FAN MOTOR			CN320 : 485 COMM		
#1: POWER L	#1: 310VDC	#1: RX	#2: NULL	#2: NULL	#2: TX			
#2: NULL	#3: AGND		#3: POWER N	#4: 15VDC				
#3: POWER N	#5: MOTOR SIGNAL		#4: NULL	#6: FEEDBACK				
#4: NULL			#5: EARTH					
#5: EARTH								
CN100 : DISPLAY / Thermistor / Wi-Fi						CN230 : DOWNLOAD		
#1: LED_CLK(DIS)	#2: 5VDC		#3: LED_DIO	#4: GND				
#3: LED_DIO	#6: H_ROOM_TEMP		#5: LED_RST(DIS)	#8: HUM_SENSOR				
#5: LED_RST(DIS)	#10: ROOM_TEMP		#7: POWER_SW	#12: GND				
#7: POWER_SW	#14: EVA_IN_TEMP		#9: GND	#16: GND				
#9: GND	#18: EVA_OUT_TEMP		#11: 5VDC	#20: GND				
#11: 5VDC	#22: AMBIENT_SCL		#13: REMOCON_INT(DIS)	#24: AMBIENT_SDA				
#13: REMOCON_INT(DIS)	#26: AMBIENT_PS		#15: ADDRESS_SW(DIS)	#28: 5VDC_1				
#15: ADDRESS_SW(DIS)			#17: MAIN_RX(DIS_WIFI)					
#17: MAIN_RX(DIS_WIFI)			#19: MAIN_TX(DIS_WIFI)					
#19: MAIN_TX(DIS_WIFI)			#21: WIFI_CONTROL(DIS_WIFI)					
#21: WIFI_CONTROL(DIS_WIFI)			#23: 12VDC					
#23: 12VDC			#25: MDS_2(DIS_DETECT)					
#25: MDS_2(DIS_DETECT)			#27: MDS_1(DIS_DETECT)					
#27: MDS_1(DIS_DETECT)								
CN340 : WIRED REMOCON (OPTION)						CN390 : Wi-Fi / VOICE (OPTION)		
#1: COM2_TX	#8: COM2_VCC_PS_OUT	#1: MAIN_RX-WIFI_TX	#2: COM2_RX	#9: GND	#2: MAIN_TX-WIFI_RX	#3: WIFI_CONTROL		
#2: COM2_RX	#10: 12VDC	#3: WIFI_CONTROL	#3: COM2_INVERTER	#11: COM2_PCTRL_MICOM	#4: GND	#5: 12VDC		
#3: COM2_INVERTER	#12: COM2_VCHECK_A		#4: COM2_ENABLE	#13: COM2_VCHECK_B				
#4: COM2_ENABLE	#14: COM2_MICOM_AD		#5: EXT_CTRL					
#5: EXT_CTRL			#6: COMP_CHK_OUT					
#6: COMP_CHK_OUT			#7: ERROR_CHK_OUT					
#7: ERROR_CHK_OUT								

7-2 Outdoor Main PCB CODE DB92-05826A

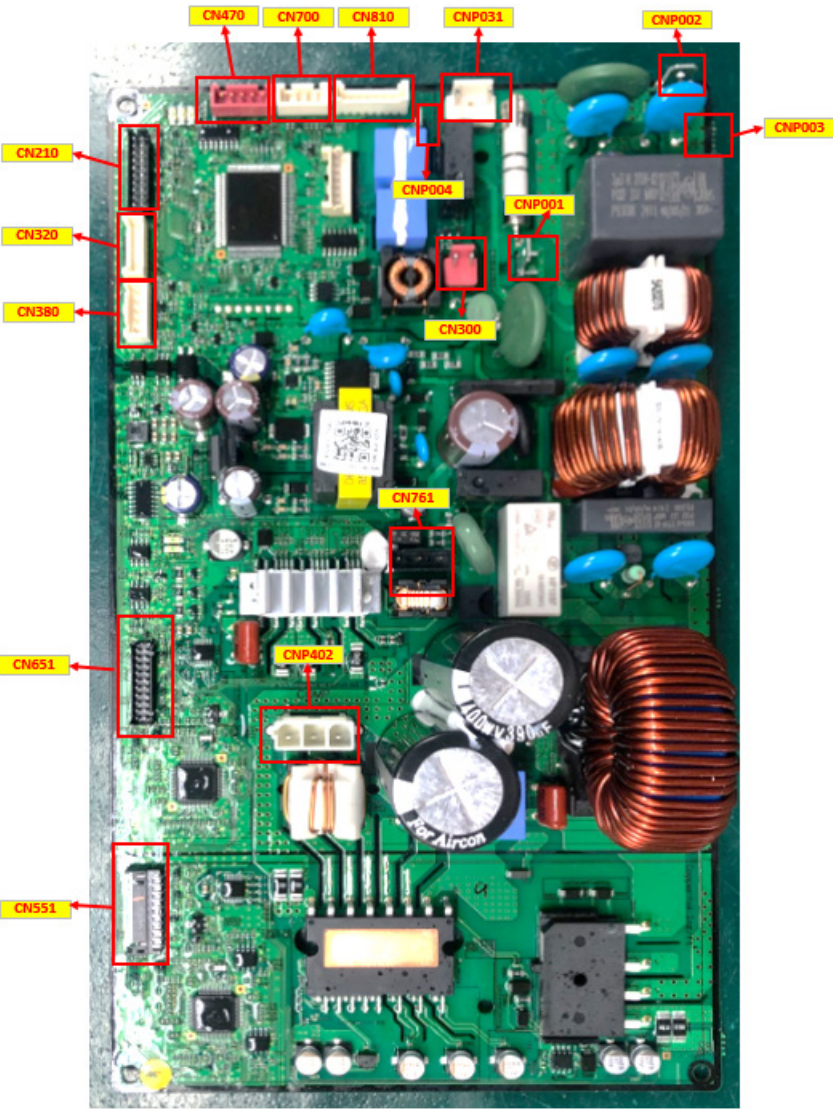

CNP001 : POWER_L	CNP401/CNP402: COMP	CN700 : HEATER
#1: L	#1: COMP SIGNAL(W)	#1: 12VDC
CNP002 : POWER_N	#2: COMP SIGNAL(V)	#2: GND
#1: N	#3: COMP SIGNAL(U)	#3: HEATER_N
CNP003 : POWER_EARTH	CNP031 : 4WAY	#4: HEATER_L
#1: POWER_EARTH	#1: AC SIGNAL	CN380 : DRED
CNP004 : COMM_EARTH	#2: NULL	#1: DRED1
#1: COMM_EARTH	#3: AC SIGNAL	#2: DRED2
CN300 : 485 COMM	CN051 : REACTOR#1 (OPTION)	#3: DRED3
#1: RX	#1: REACTOR#1	#4: GND
#2: TX	CN052 : REACTOR#2 (OPTION)	#5: 5VDC
	#1: REACTOR#2	
CN761 : BLDC FAN MOTOR	CN810 : EEV	CN320 : SUB COMM (OPTION)
#1: FAN SINGNAL (U)	#1: SIGNAL1	#1: 5VDC
#2: NULL	#2: SIGNAL2	#2: ENABLE
#3: FAN SINGNAL (V)	#3: SIGNAL3	#3: INVERSE
#4: NULL	#4: SIGNAL4	#4: TXD
#5: FAN SINGNAL (W)	#5: 12VDC	#5: RXD
CN470 : THERMISTOR	CN800 : EEPROM	#6: GND
#1: OUT_TH	#1: GND	#7: 12VDC
#2: GND	#2: NULL	CN210 : DOWNLOAD_MAIN
#3: DIS_TH	#3: 5VDC	CN651 : DOWNLOAD_FAN
#4: GND	#4: EEP_CS	CN551 : DOWNLOAD_COMP
#5: COND_TH	#5: EEP_SO	
#6: GND	#6: EEP_SI	
#7: OLP_TH	#7: EEP_CLK	
#8: GND		

7-3 Outdoor Main PCB CODE DB92-05844A

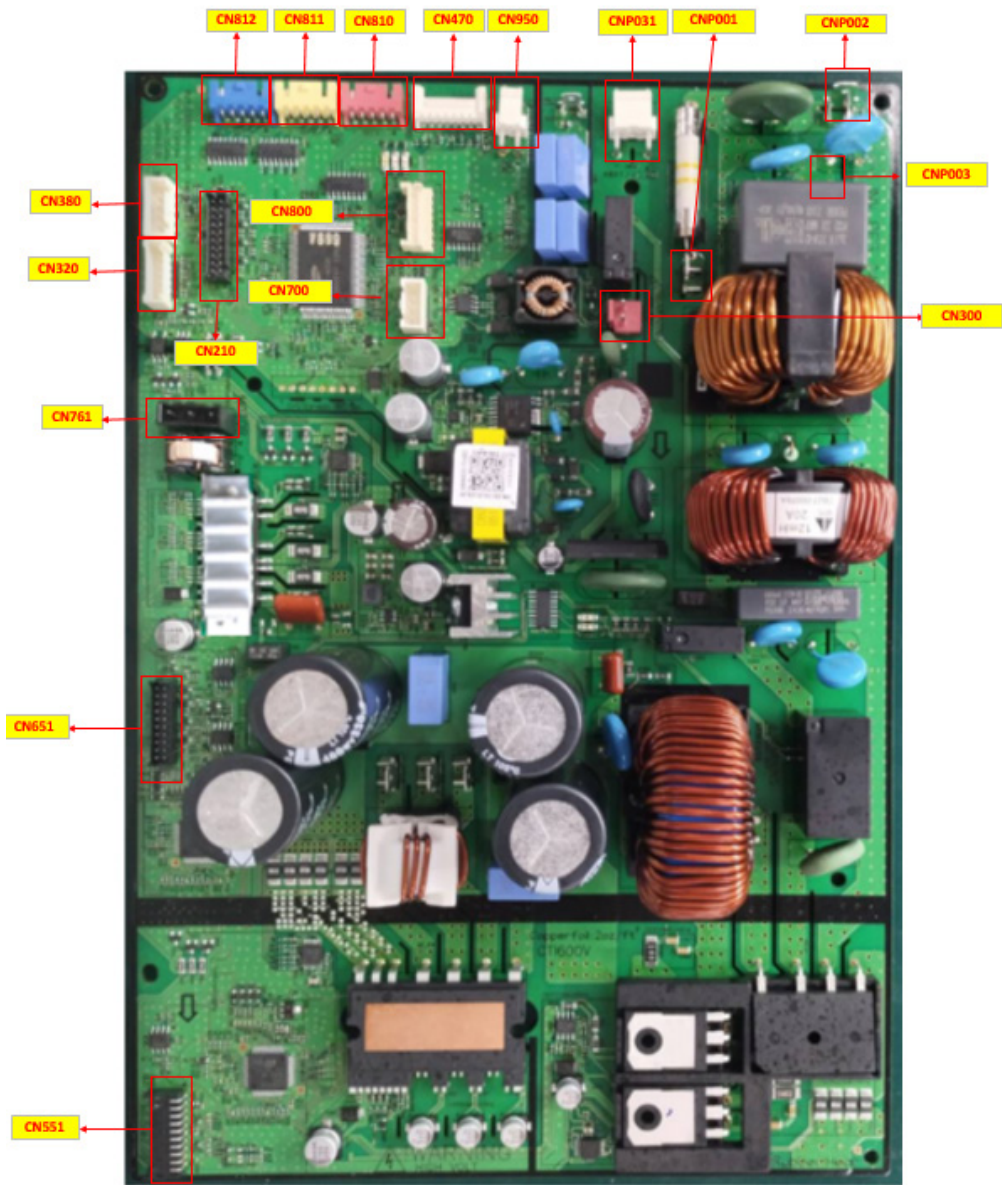

CNP001 : POWER_L	CNP401/CNP402: COMP	CN700 : HEATER
#1: L	#1: COMP SIGNAL(W)	#1: 12VDC
CNP002 : POWER_N	#2: COMP SIGNAL(V)	#2: GND
#1: N	#3: COMP SIGNAL(U)	#3: HEATER_N
CNP003 : POWER_EARTH	CNP031 : 4WAY	#4: HEATER_L
#1: POWER_EARTH	#1: AC SIGNAL	CN380 : DRED
CNP004 : COMM_EARTH	#2: NULL	#1: DRED1
#1: COMM_EARTH	#3: AC SIGNAL	#2: DRED2
CN300 : 485 COMM	CN051 : REACTOR#1 (OPTION)	#3: DRED3
#1: RX	#1: REACTOR#1	#4: GND
#2: TX	CN052 : REACTOR#2 (OPTION)	#5: 5VDC
	#1: REACTOR#2	
CN761 : BLDC FAN MOTOR	CN810 : EEV	CN320 : SUB COMM (OPTION)
#1: FAN SINGNAL (U)	#1: SIGNAL1	#1: 5VDC
#2: NULL	#2: SIGNAL2	#2: ENABLE
#3: FAN SINGNAL (V)	#3: SIGNAL3	#3: INVERSE
#4: NULL	#4: SIGNAL4	#4: TXD
#5: FAN SINGNAL (W)	#5: 12VDC	#5: RXD
CN470 : THERMISTOR	CN800 : EEPROM	#6: GND
#1: OUT_TH	#1: GND	#7: 12VDC
#2: GND	#2: NULL	CN210 : DOWNLOAD_MAIN
#3: DIS_TH	#3: 5VDC	CN651 : DOWNLOAD_FAN
#4: GND	#4: EEP_CS	CN551 : DOWNLOAD_COMP
#5: COND_TH	#5: EEP_SO	
#6: GND	#6: EEP_SI	
#7: OLP_TH	#7: EEP_CLK	
#8: GND		

7-4 DISPLAY PCB

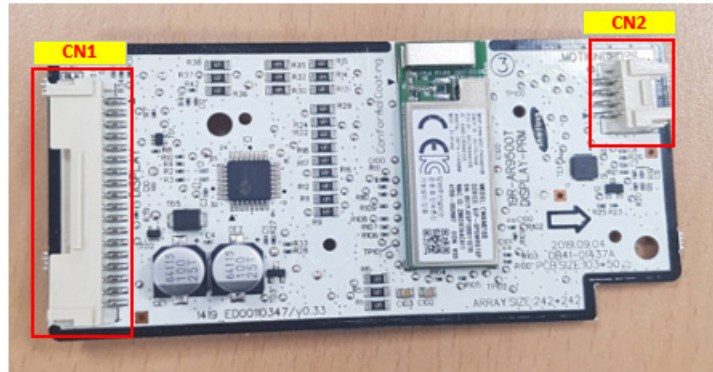

CN1 : DISPLAY	CN2: DETECT
#1: LED_CLK(DIS)	#1:5V_1
#2: LED_DIO	#2GND
#3: LED_RST(DIS)	#3:MDS_1
#4: POWER_SW	#4:MDS_2
#5:GND	
#6:5VDC	
#7: REMOCON_INT(DIS)	
#8: ADDRESS_SW(DIS)	
#9: MAIN_RX(DIS_WIFI)	
#10: MAIN_TX(DIS_WIFI)	
#11: WIFI_CONTROL(DIS_WIFI)	
#12: 12VDC	
#13: MDS_2(DIS_DETECT)	
#14: MDS_1(DIS_DETECT)	
#15: 5V_1	
#16: AMBIENT_PS	
#17: AMBIENT_SDA	
#18: AMBIENT_SCL	

7-5 Wire connecting the indoor unit terminal blocks

1. The pressed ring connector needs to face up before connecting the wire.



Is inverted



Terminal has been cut.

2. There shall be no empty space between Ring terminal and Screw after Clamp.
If not, there is a possibility of fire which can be caused by electric heat in the connecting part.



①



②



③

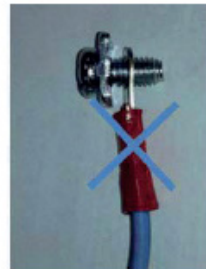

④



⑤



⑥

①, ② : Good

③ Bad : Ring terminal is connected reversely

④ Bad: Screw not fastened all the way

⑤ Bad: There should be no gap between terminal and screw after fixing.

⑥ Bad : Unused Ring Terminal

8. Operating Instructions

8-1 Name of Each Part

8-1-1 Indoor Unit

The design and shape are subject to change according to the model.

◆ Main Parts

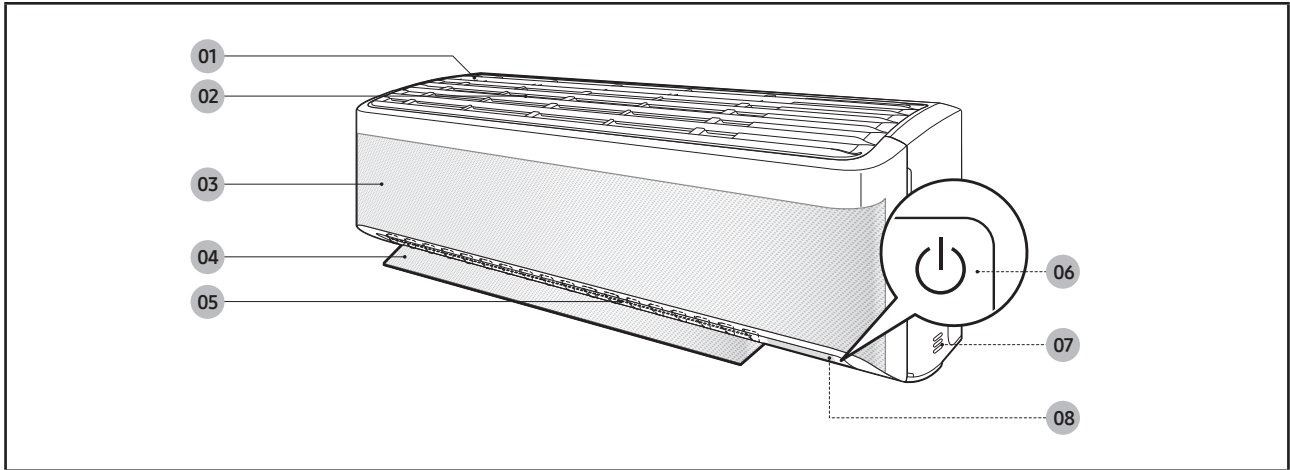

- | | |
|--------------------------------|---|
| 01 Air intake | 05 Airflow blade (left and right) |
| 02 Air filter | 06 Power button/Remote control receiver |
| 03 WindFree panel | 07 Room temperature sensor |
| 04 Airflow blade (up and down) | 08 Display |

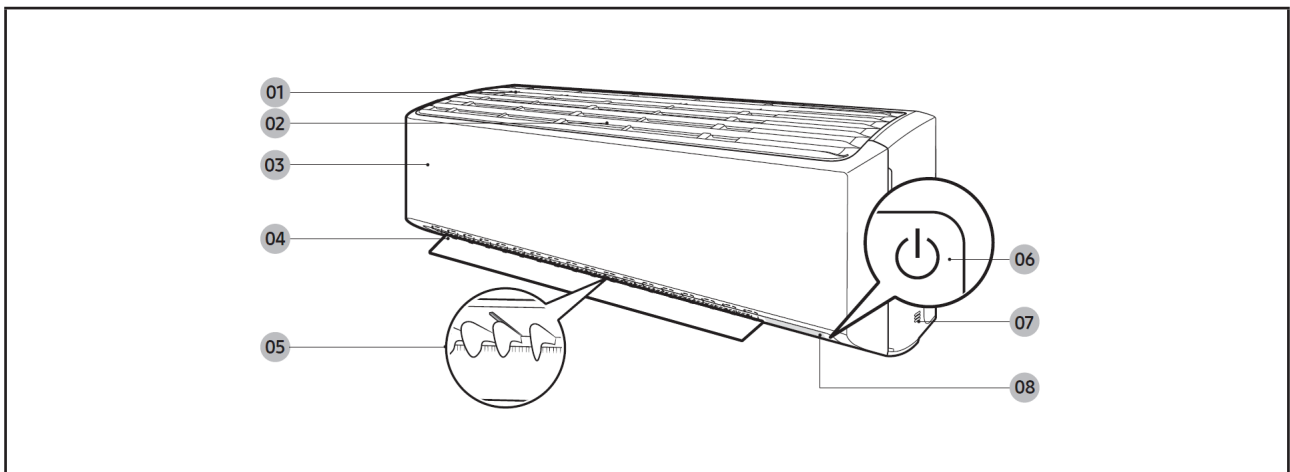

- | | |
|--------------------------------|---|
| 01 Air intake | 05 Airflow blade (left and right) |
| 02 Air filter | 06 Power button/Remote control receiver |
| 03 Front panel | 07 Room temperature sensor |
| 04 Airflow blade (up and down) | 08 Display |

◆ Display

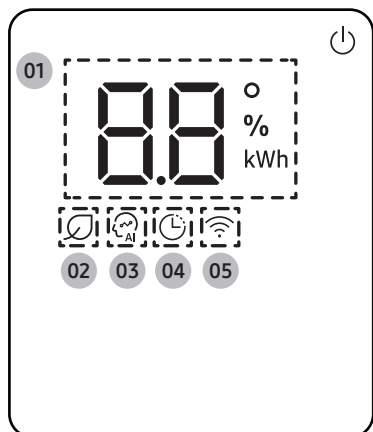

- 01 Temperature indicator (numeric)
Filter reset indicator (EF)
Electricity consumption indicator (numeric)
Auto clean indicator (E !)
Defrost indicator (dF)
- 02 AI Energy indicator
- 03 AI Auto indicator
- 04 Timer indicator
good'sleep indicator
- 05 Wi-Fi indicator

NOTE

- When the Wi-Fi is turned on, the indicator blinks three times and then turn on.

8-2 Wireless Remote control-Buttons and Display

DB96-25924T

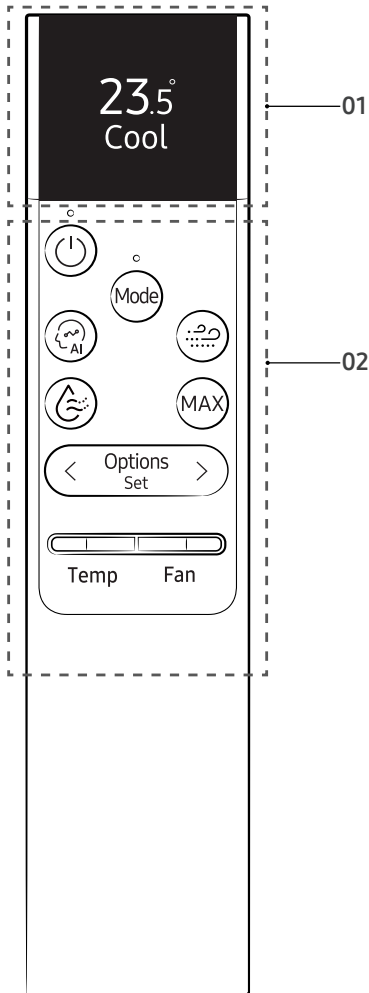

01 Display

02 Buttons

NOTE

- Features may differ depending on models.
- Although WindFree, Motion detection, Freeze Wash and Heating Range is displayed on the remote control display, it is not available on this model.

Functions and Buttons

Function	Button and Selection	Display
Power On/Off		
AI Auto		
Cool	► ► Select Cool.	
Dry	► Select Dry. or In Cool mode ►	
Heat	► ► Select Heat.	
Max	In Cool or Heat mode ►	
Eco	In Cool or Heat mode ► ► ► Select Eco. ►	
Quiet	In Cool or Heat mode ► ► ► Select Quiet. ►	
Beep	In operation ► ► ► Select Settings. ► ► ► Select Beep. ►	

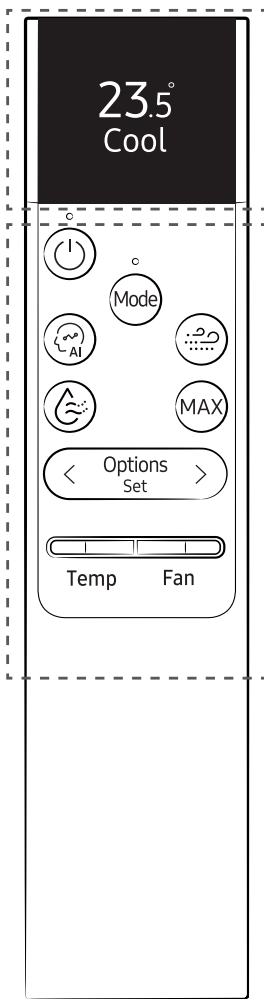

Function	Button and Selection	Display
Display Lighting	In operation ▶ < Options Set > ▶ < Options Set > ▶ Select Settings. ▶ < Options Set > ▶ < Options Set > ▶ Select Lighting. ▶ < Options Set >	
Wi-Fi (SmartThings)	▶ Press and hold for 5 or more seconds.	
Wi-Fi (On/Off)	and < Options Set > ▶ Press and hold for 5 or more seconds.	
Timed on/off	< Options Set > ▶ < Options Set > ▶ Select Timer/Good sleep. ▶ < Options Set > ▶ < Options Set > ▶ Select On timer or Off timer. ▶ < Options Set > ▶ < Options Set > (Set the duration.) ▶ < Options Set >	
Good sleep	In Cool or Heat mode ▶ < Options Set > ▶ < Options Set > ▶ Select Timer/Good sleep. ▶ < Options Set > ▶ < Options Set > ▶ Select Good sleep. ▶ < Options Set > ▶ < Options Set > (Set the duration.) ▶ < Options Set >	

Charging the remote control

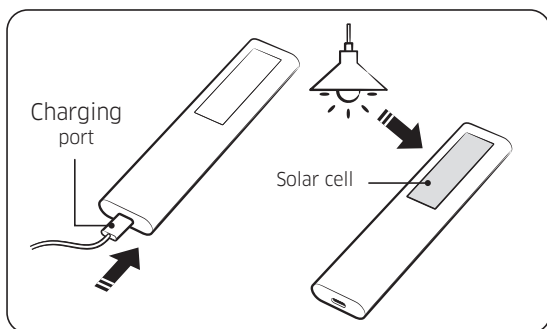

- Fully charge the remote control before use.
- If “Low battery” appears on the remote control display, charge the remote control by using the USB port (C-Type) at the bottom of the remote control. If you keep the remote control facing down, it is charged via the solar cell, allowing the battery to last longer.
- When charging the remote control is complete, “Complete” appears on the display. Then, remove the charging cable.
- If the remote control will not be used for an extended period of time, make sure to charge the remote control. Before storage, charge the remote control by using the USB port.

NOTE

- The product does not come with a remote control charging cable or charger.

9. Troubleshooting

9-1 Items to be checked first

- 1 The input voltage should be rating voltage $\pm 10\%$ range. The air conditioner may not operate properly if the voltage is out of this range.
- 2 Is the line cable linking the indoor unit and the outdoor unit linked properly? The indoor unit and the outdoor unit shall be linked by 5 cables. Check the terminals if the indoor unit and outdoor unit are properly linked by the same number of cables. Otherwise the air conditioner may not operate properly.
- 3 When a problem occurs due to the contents illustrated in the table below it is a symptom not related to the malfunction of the air conditioner.

NO.	Operation of air conditioner	Explanation
1	The OPERATION indication LED(BLUE) blinks when a power plug of the indoor unit is plugged in for first time.	It indicates power is on. The LED stops blinking if the operation ON/OFF button on the remote control unit is pushed.
2	When turning off and on immediately or connecting the power right away, the compressor may not operate immediately in cooling mode. [In case of heat pump model] When turning off and on immediately or connecting the power right away, the compressor may not operate immediately in Heating mode.	This happens after a delay of 3 minutes when the compressor is re-operated. The same phenomenon occurs when the power is on. As an occurrence in heating mode, if the compressor is re-operated after a delay of 3 minutes, the indoor fan speed may automatically adjust according to the discharge air temperature.
3	Fan speed setting is not allowed in DRY mode.	The speed of the indoor fan is set to Low Low in DRY mode. Fan speed is selected automatically in AUTO mode.
4	Compressor stops operation intermittently in Dry mode.	Compressor operation is controlled automatically in DRY mode depending on the room temperature and humidity.
5	Timer LED(ORANGE) of the indoor unit lights up and the air conditioner does not operate.	Timer is being activated and the unit is in ready mode. The unit operates normally if the timer operation is cancelled.
6	The compressor stops intermittently in a COOL mode or DRY mode, and fan speed of the indoor unit decreases.	The compressor stops intermittently or the fan speed of the indoor unit decreases to prevent inside/outside air frozen depending on the inside/outside air temperature.
7	[In case of heat pump model] Compressor of the outdoor unit is operating although it is turned off in a HEAT mode.	When the unit is turned off while de-ice is activated, the compressor continues operation for up to 9 minutes(maximum) until the deice is completed.
8	[In case of heat pump model] The compressor and indoor fan stop intermittently in HEAT mode.	The compressor and indoor fan stop intermittently if room temperature exceeds a set temperature in order to protect the compressor from overheated air in a HEAT mode.
9	[In case of heat pump model] Indoor fan and outdoor fan stop operation intermittently in a HEAT mode.	The compressor operates in a reverse cycle to remove exterior ice in a HEAT mode, and indoor fan and outdoor fan do not operate intermittently for within 20% of the total heater operation.

9-2 Communication Error

9-2-1 Communication Error

Indoor display

7-SEG DISPLAY	DESCRIPTION
C101/C102	Communication error(Indoor<->outdoor)
C201	COMMUNICATION ERROR (INDOOR - OUTDOOR MATCHING)
C202	COMMUNICATION ERROR (INDOOR - OUTDOOR)
C205	TIME OUT COMM.(MAIN MICOM - COMP MICOM and FAN MICOM)
C206	TIME OUT COMM.(MAIN MICOM - COMP MICOM or FAN MICOM)

Outdoor display

●	●	●	1min. Time out Comm. TIME OUT COMM.(MAIN MICOM - COMP MICOM and FAN MICOM) TIME OUT COMM.(MAIN MICOM - COMP MICOM or FAN MICOM)
○	○	●	Abnormal Communication COMMUNICATION ERROR (INDOOR - OUTDOOR MATCHING) COMMUNICATION ERROR (INDOOR - OUTDOOR)
○	●	●	Abnormal Communication

● LED ON ◐ LED BLINKING ○ LED OFF

1. Checklist :

- 1) Is the cable between the indoor unit and outdoor unit connected correctly?
- 2) Aren't the power cable and communication cable cross wired?

2. Troubleshooting procedure

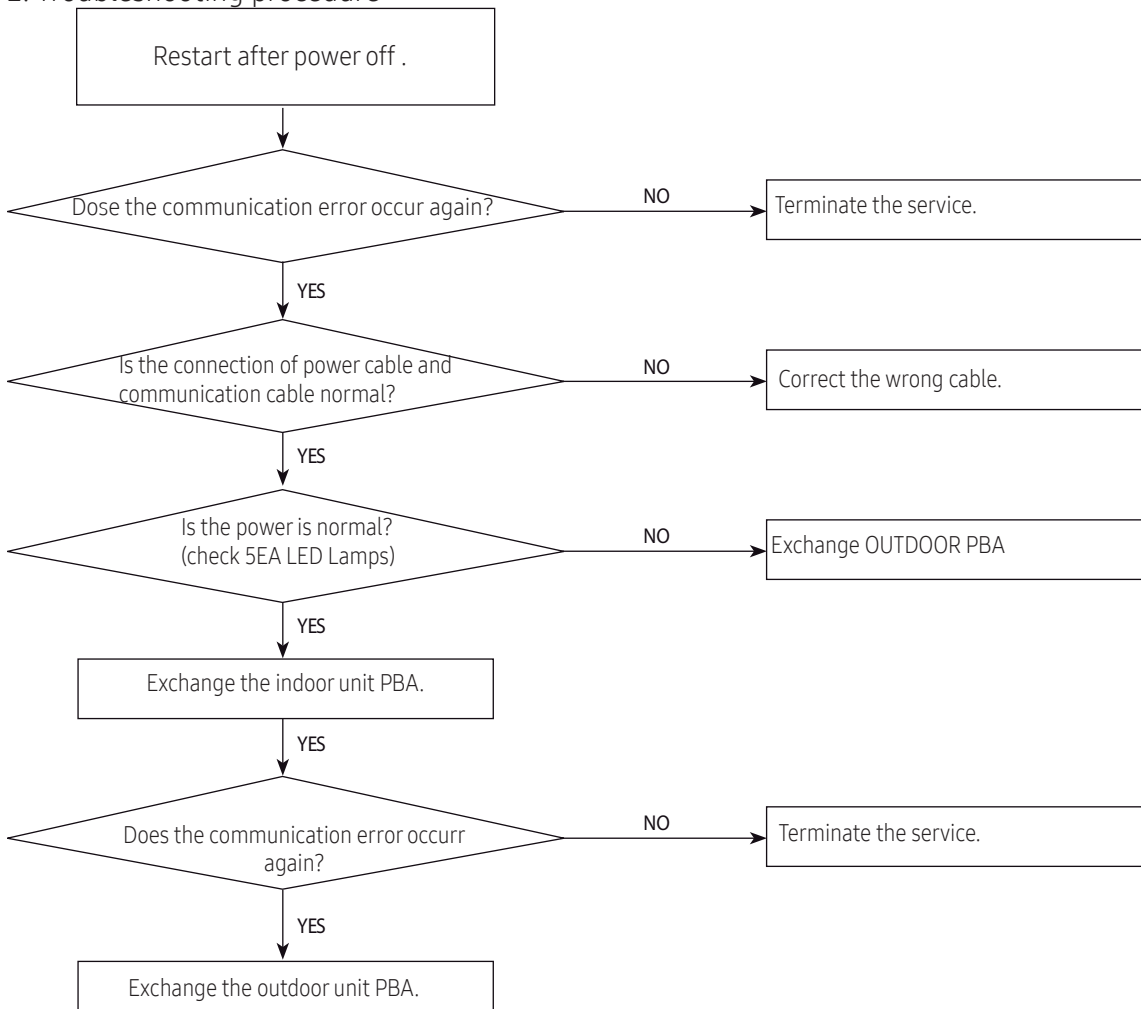

9-2-2 Indoor temperature sensor Error

Indoor display

7-SEG DISPLAY	DESCRIPTION
C121	Indoor room temp sensor error

● LED ON ● LED BLINKING ○ LED OFF

1. Checklist :

- 1) Is the indoor units temperature sensor connected correctly?
- 2) Is the sensor placed correctly?
- 3) Does the sensor have the correct resistance value in accordance with the expected resistance value at that specific room temperature?

2. Troubleshooting procedure

Model	"A"	"B"
ALL	CN100	CN100 #10-#12

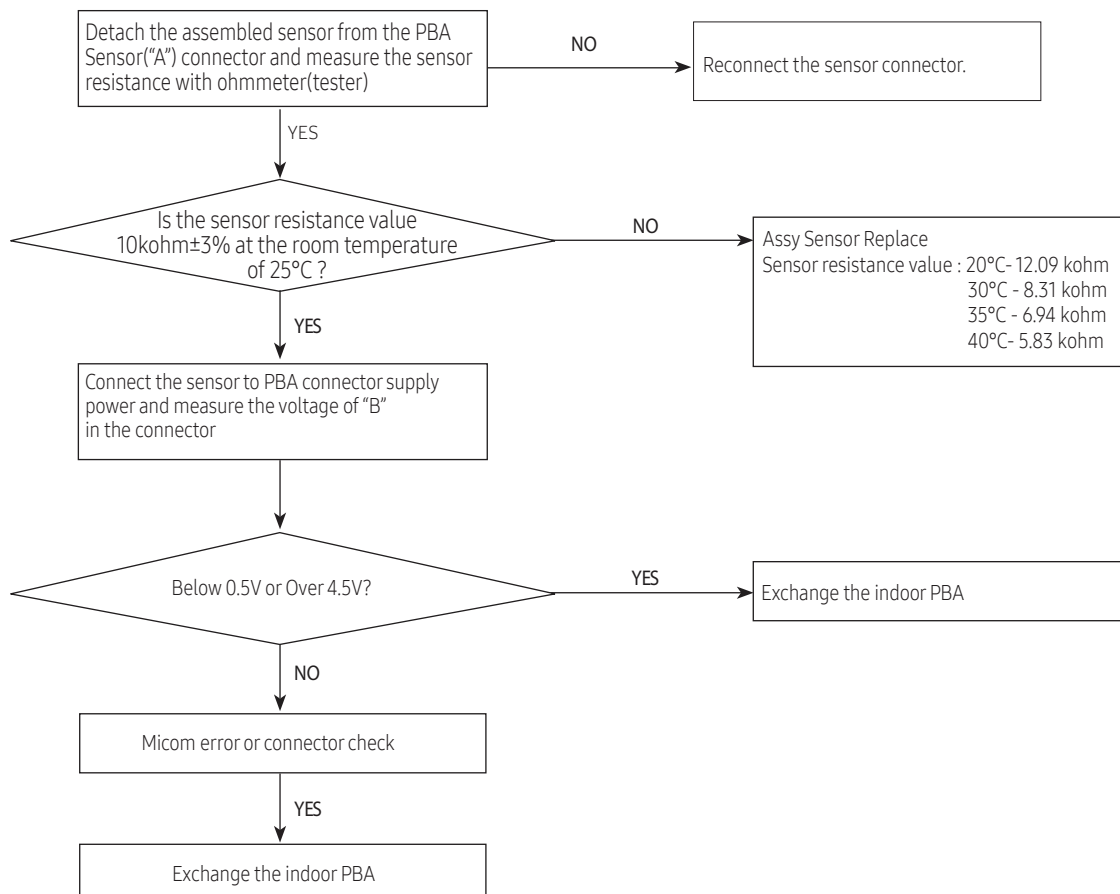

9-2-3 Indoor fan motor speed detecting error (BLDC fan)

Indoor display

7-SEG DISPLAY	DESCRIPTION
C154	Indoor fan error

● LED ON ● LED BLINKING ○ LED OFF

1. Checklist :

- 1) Is the indoor units fan motor properly connected with the connector(CN900)?
- 2) Is the AC voltage correct?

2. Troubleshooting procedure

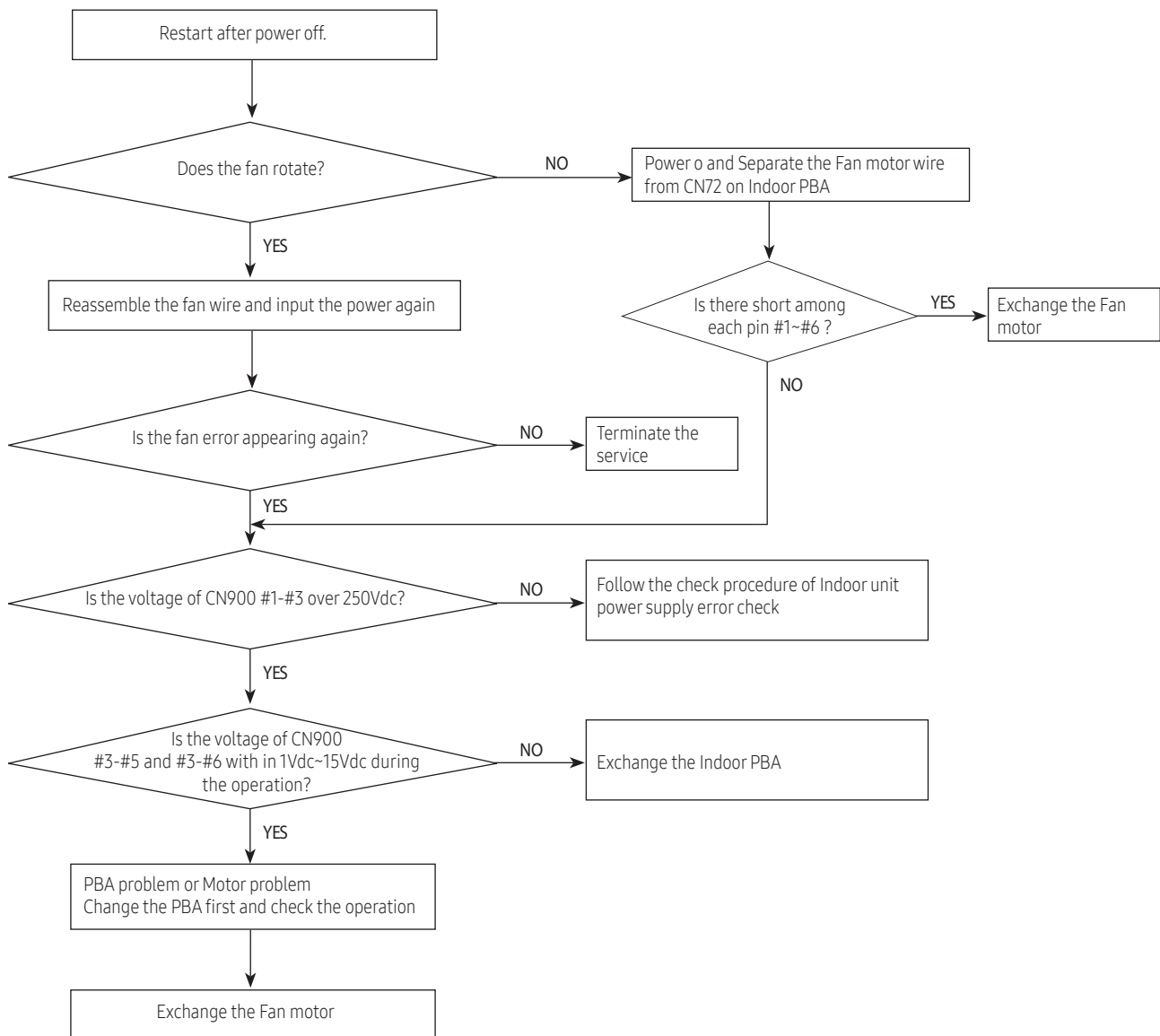

9-2-4 Outdoor temperature sensor error

Indoor display

7-SEG DISPLAY	DESCRIPTION
C221	Outdoor temperature sensor error

Outdoor display

●	○	●	Outdoor temperature sensor error
---	---	---	----------------------------------

● LED ON ● LED BLINKING ○ LED OFF

1. Checklist :

- 1) Is the sensor connected correctly?
- 2) Is the sensor placed correctly?
- 3) Does the sensor have the correct resistance value in accordance with the expected resistance value at that specific room temperature?

2. Troubleshooting procedure

Model	"A"	"B"
ALL	CN470	CN470 #1-#2

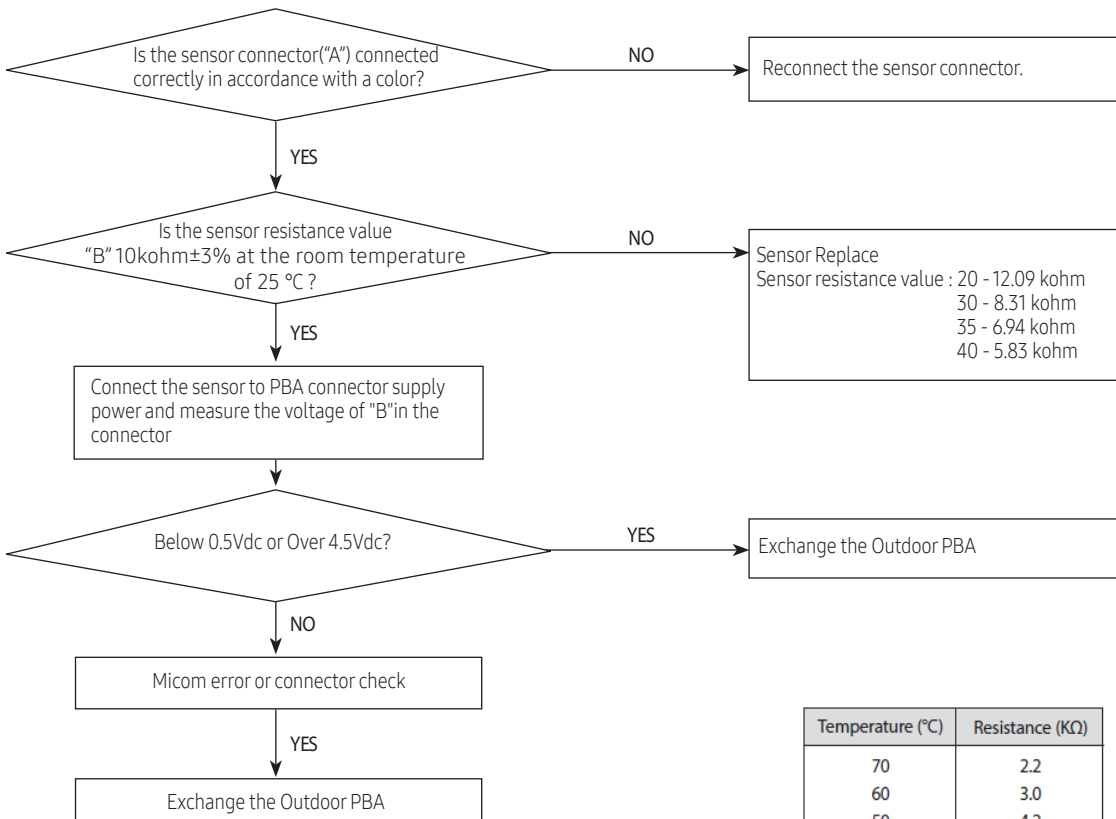

Temperature (°C)	Resistance (KΩ)
70	2.2
60	3.0
50	4.2
40	5.8
30	8.3
20	12.1
10	18.0
0	27.3
-10	43.0

9-2-5 Outdoor Cond temperature sensor error

Indoor display

7-SEG DISPLAY	DESCRIPTION
C231	Outdoor Cond temperature sensor error

Outdoor display



● LED ON ◐ LED BLINKING ○ LED OFF

1. Checklist :

- 1) Is the sensor connected correctly?
- 2) Is the sensor placed correctly?
- 3) Do both terminals of the sensor satisfy the resistance value in accordance with temperature?
- 4) Is the resistance value of sensor connection pull-up correct?

2. Troubleshooting procedure

Model	"A"	"B"
ALL	CN470	CN470 #5-#6

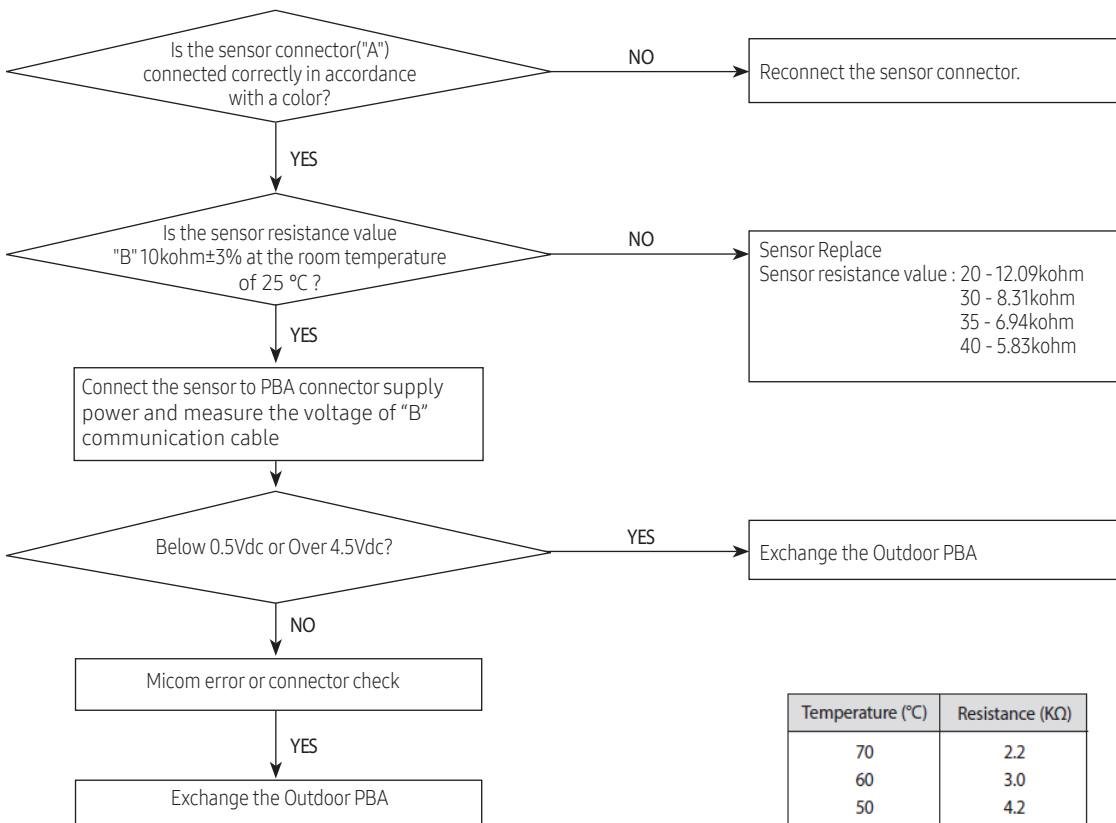

Temperature (°C)	Resistance (KΩ)
70	2.2
60	3.0
50	4.2
40	5.8
30	8.3
20	12.1
10	18.0
0	27.3
-10	43.0

9-2-6 Outdoor Discharge temperature sensor error

Indoor display

7-SEG DISPLAY	DESCRIPTION
C251	Outdoor Discharge temperature sensor error

Outdoor display



● LED ON ● LED BLINKING ○ LED OFF

1. Checklist :

- 1) Is the sensor connected correctly?
- 2) Is the sensor placed correctly?
- 3) Do both terminals of the sensor satisfy the resistance value in accordance with temperature?
- 4) Is the resistance value of sensor connection pull-up correct?

2. Troubleshooting procedure

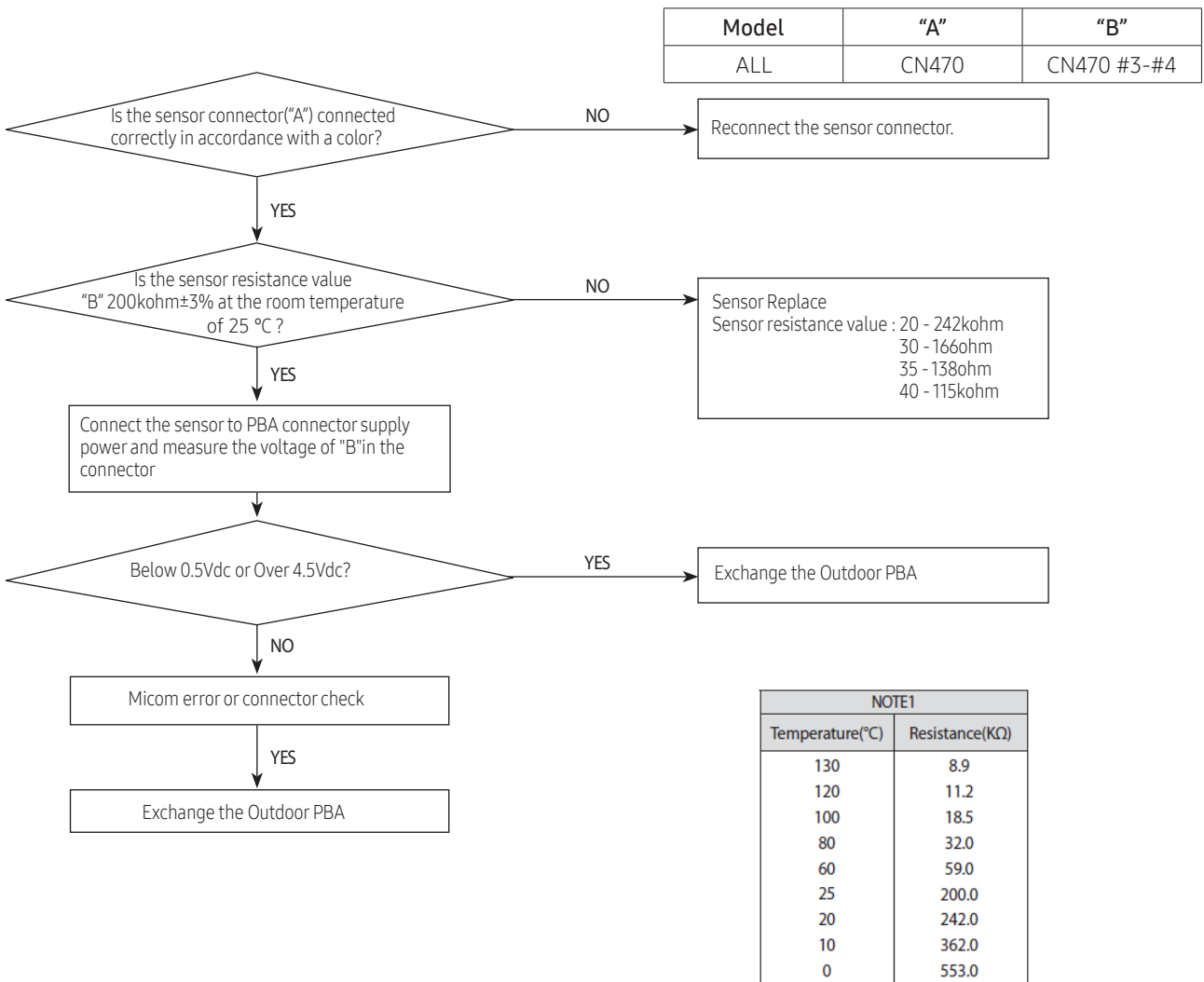

9-2-7 Operation condition secession error

Indoor display

7-SEG DISPLAY	DESCRIPTION
C440	Prohibit Operation Condition Error (Heating)
C441	Prohibit Operation Condition Error (Cooling)

Outdoor display



● LED ON ● LED BLINKING ○ LED OFF

1. Checklist :

- 1) Check the temperature around the outdoor unit.

2. Troubleshooting procedure

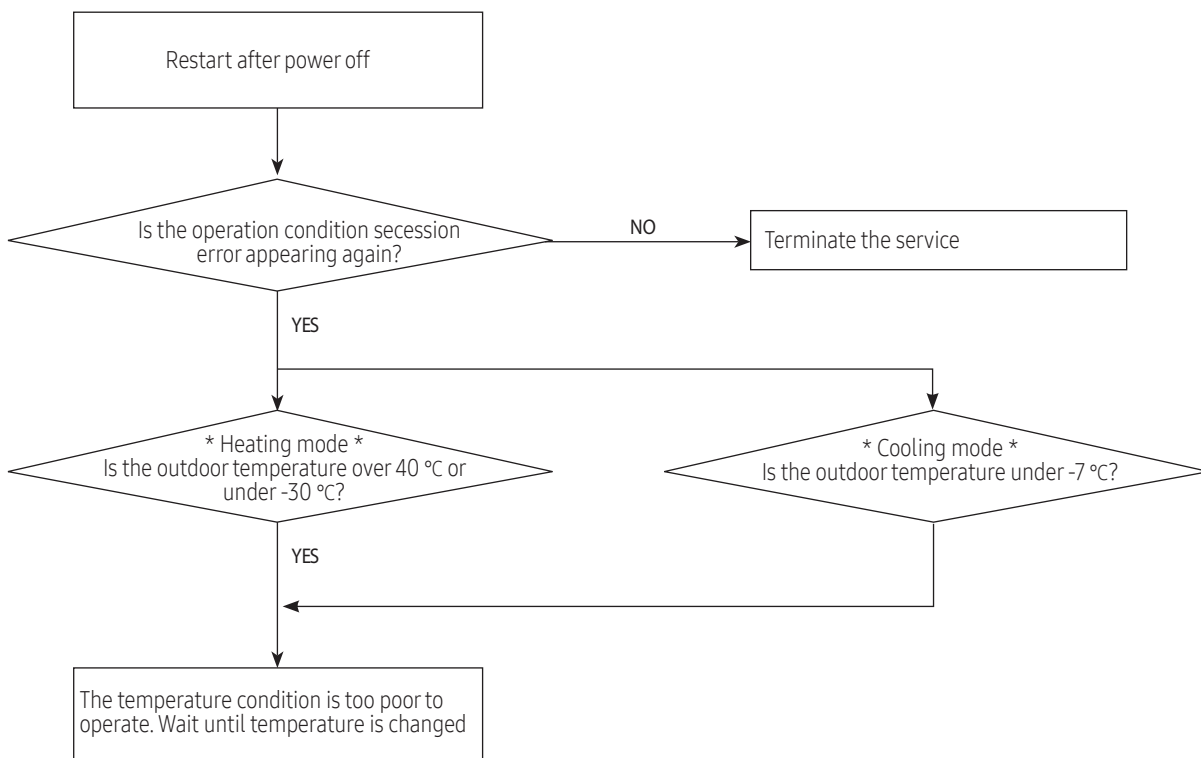

9-2-8 EEPROM error

Indoor display

7-SEG DISPLAY	DESCRIPTION
C470	EEPROM Data Error (no data)

Outdoor display

			EEPROM Data Error (no data)
---	---	---	-----------------------------

 LED ON  LED BLINKING  LED OFF

1. Checklist :

- 1) Is there a short around micom?
- 2) Did you download or insert EEPROM IC, after changing outdoor PBA?

2. Troubleshooting procedure

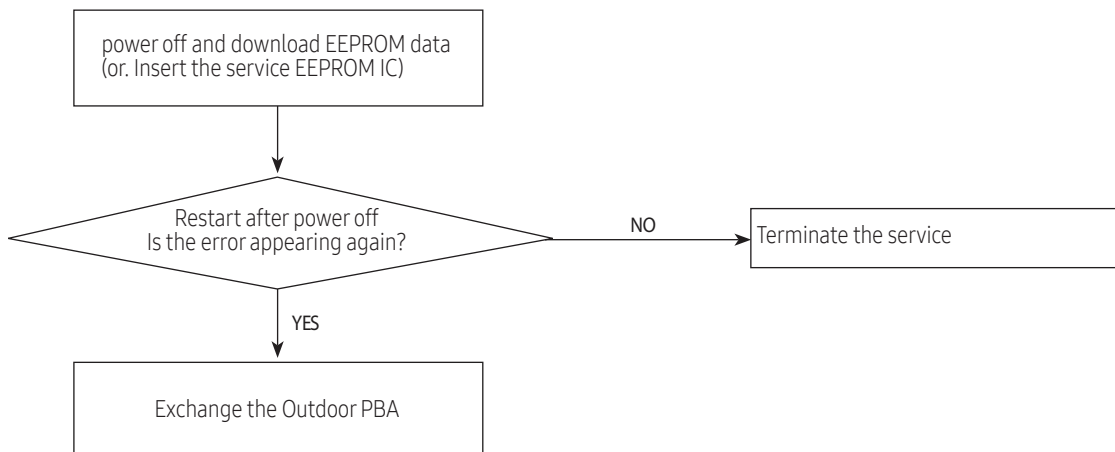

9-2-9 Compressor starting error

Indoor display

7-SEG DISPLAY	DESCRIPTION
C461	Comp starting error

Outdoor display

○	●	○	Comp starting error
---	---	---	---------------------

● LED ON ● LED BLINKING ○ LED OFF

1. Checklist :

- 1) Is the connection of cable for the compressor?
- 2) Is the compressor wire Connected clockwise? U(RED)-V(BLU)-W(YEL)
- 3) Is the interphase resistance of compressor normal?

2. Troubleshooting procedure

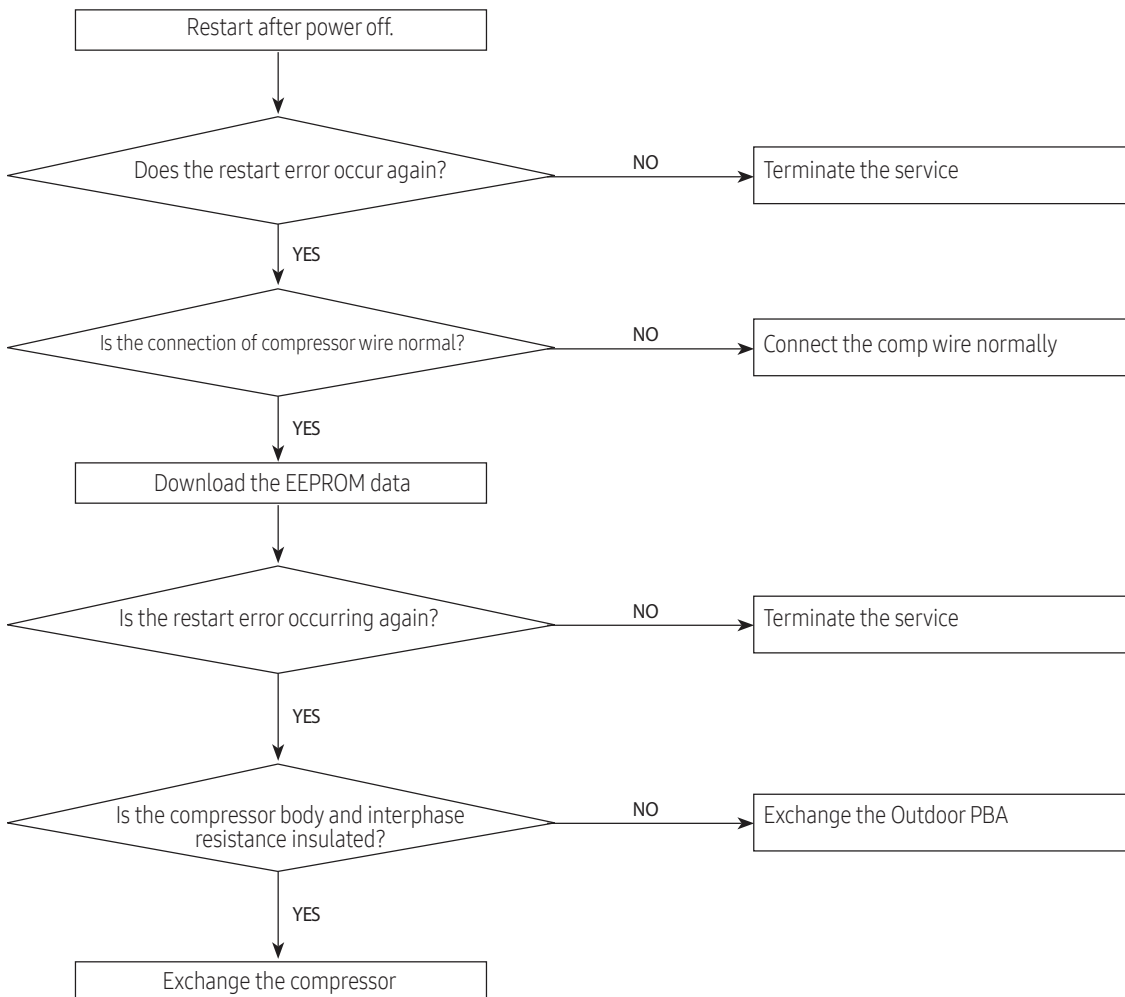

9-2-10 Compressor wire missing error/rotation error

Indoor display

7-SEG DISPLAY	DESCRIPTION
C467	Compressor wire missing error/rotation error

Outdoor display

●	○	●	Compressor wire missing error/rotation error
---	---	---	--

● LED ON ◐ LED BLINKING ○ LED OFF

1. Checklist :

- 1) Is the connection of cable for the compressor?
- 2) Is the compressor wire connected clockwise? U(RED)-V(BLU)-W(YEL)
- 3) Is the interphase resistance of compressor normal?

2. Troubleshooting procedure

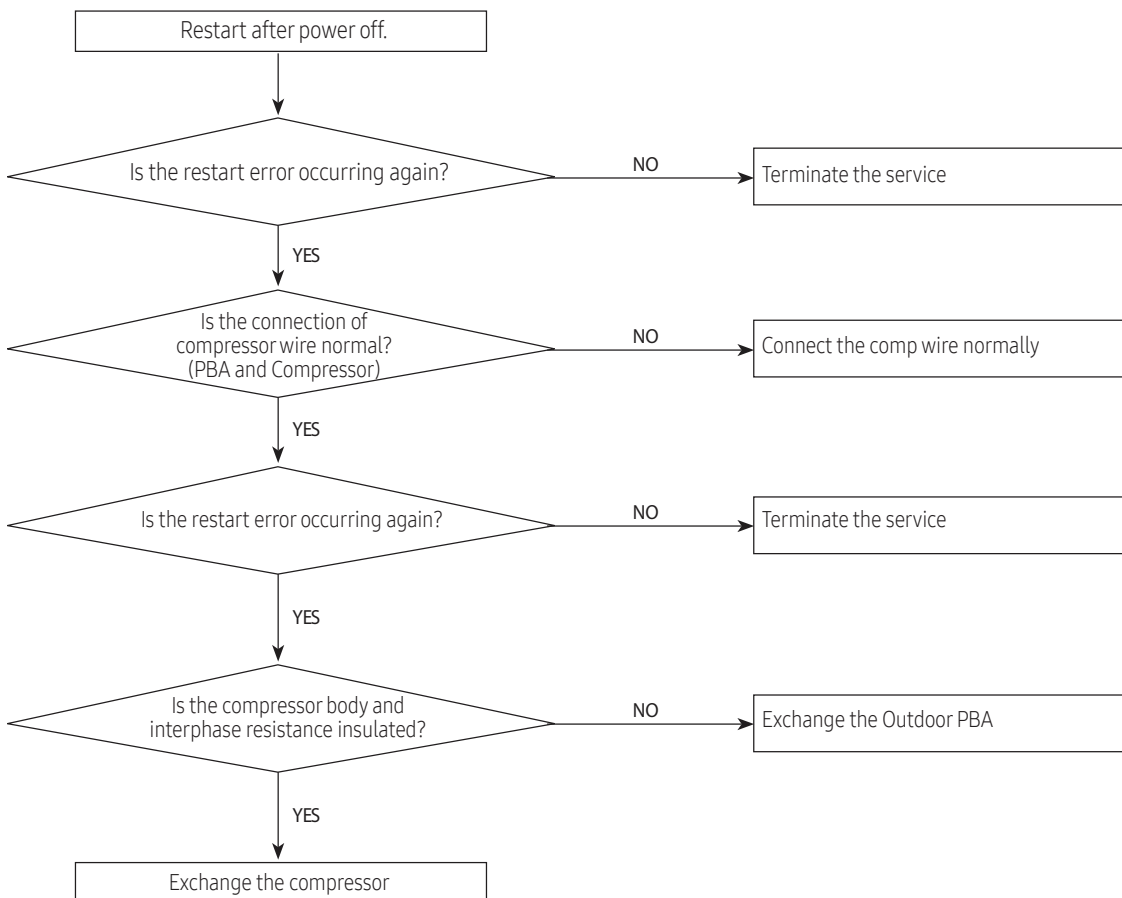

9-2-11 Current sensor error/Input current sensor error

Indoor display

7-SEG DISPLAY	DESCRIPTION
C462	AC Input I_Limit Trip Error

Outdoor display

●	◐	●	Current sensor error
			Input current sensor error

● LED ON ◐ LED BLINKING ○ LED OFF

1. Checklist :

- 1) Is the PFC Shunt("A") resistance value correct? Check if the resistor is open
- 2) Is the IPM Shunt("B") resistance value correct? Check if the resistor is open
- 3) Is there no short or open around "C"?

2. Troubleshooting procedure

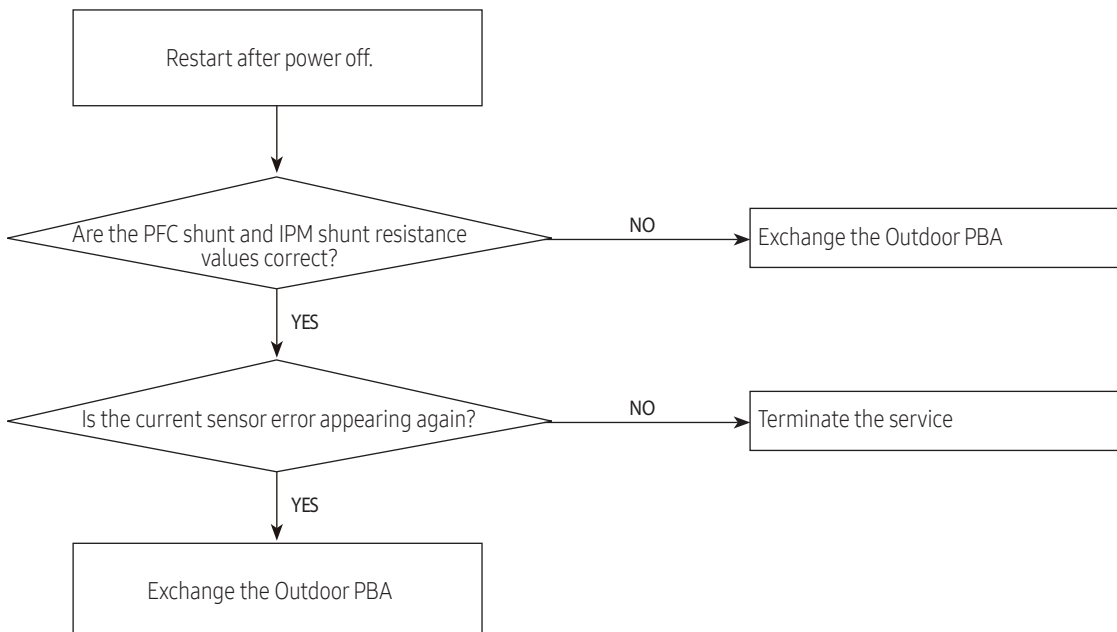

9-2-12 O.C(Over Current) error

Indoor display

7-SEG DISPLAY	DESCRIPTION
C464	COMP IPM OVER CURRENT(O.C) ERROR

Outdoor display

○	○	◐	COMP IPM OVER CURRENT(O.C) ERROR
---	---	---	----------------------------------

● LED ON ◐ LED BLINKING ○ LED OFF

1. Checklist :

- 1) Is the IPM Shunt resistance value correct? Check if the resistor is open
- 2) Is the condition of surrounding temperature leading to an abnormal overload?
- 3) Is there any problem like the temperature sensor separation or measurement value error?
- 4) Is the interphase resistance of compressor normal?

2. Troubleshooting procedure

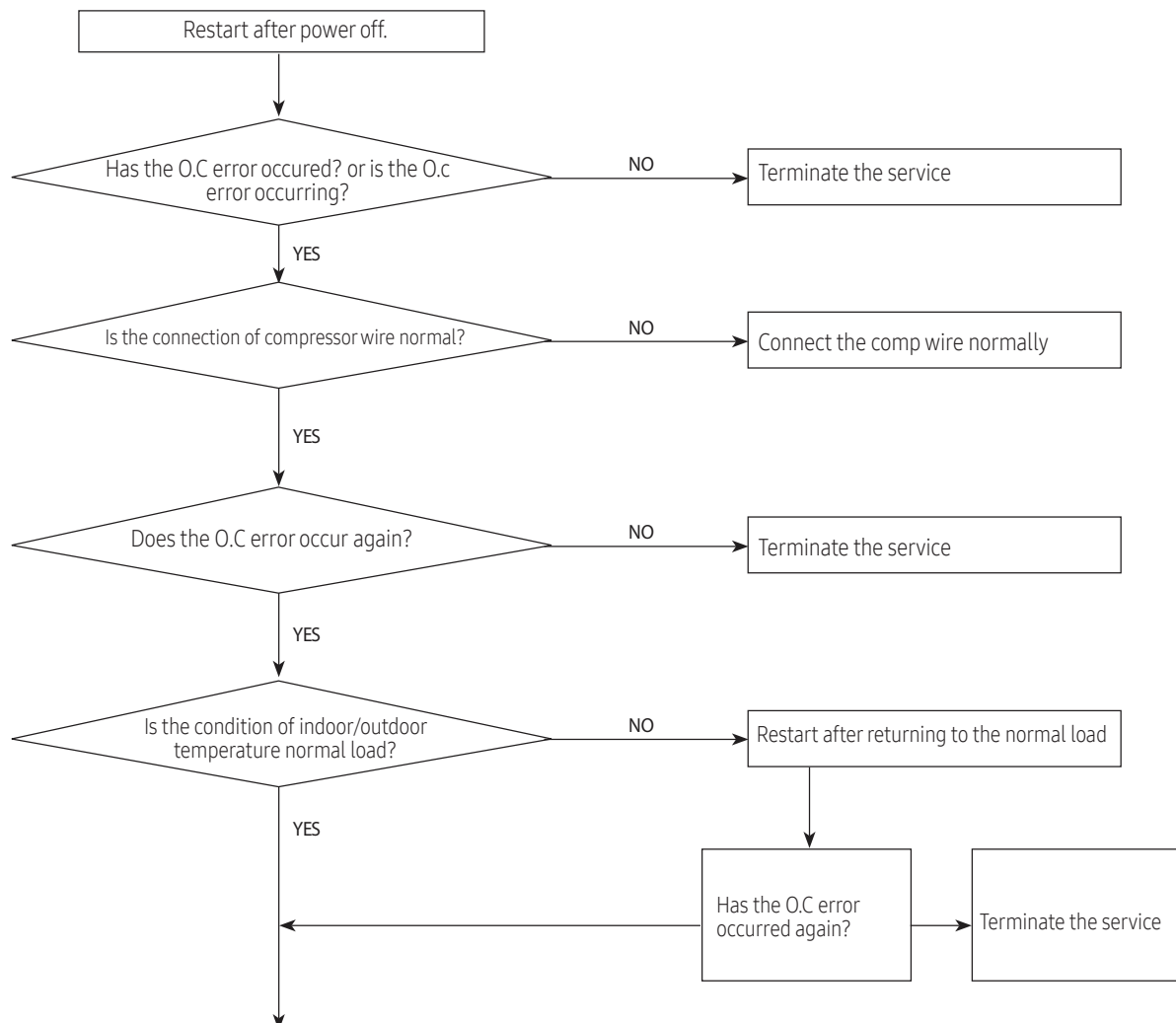

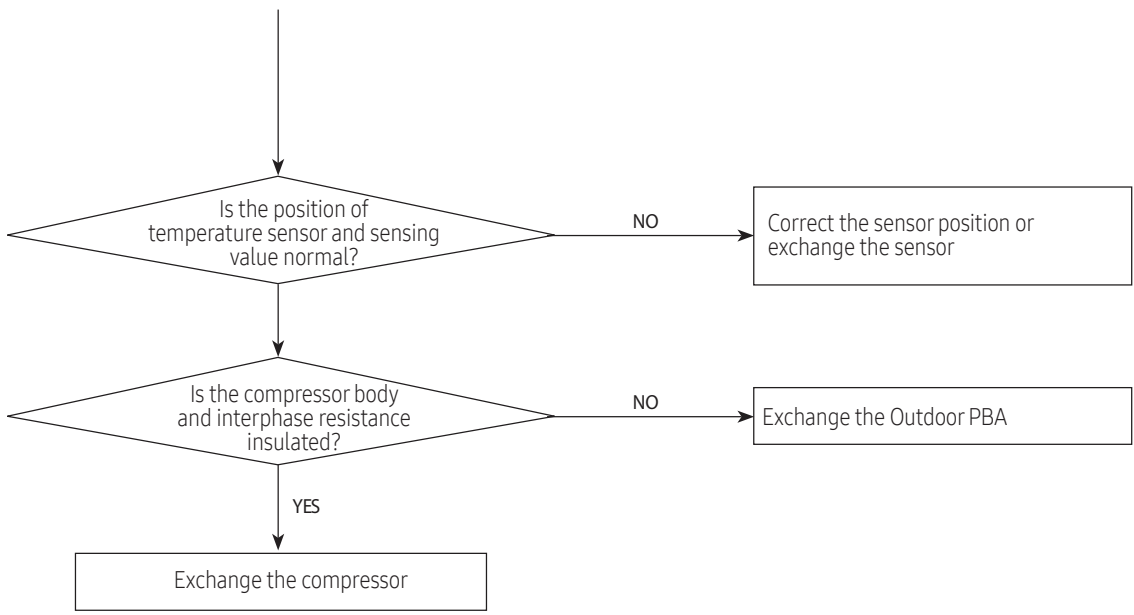

9-2-13 No power outdoor (Initial Diagnosis) (Not displayed)

1. Checklist :

- 1) Is input power normal?
- 2) Is AC power linked correctly? (L,N,E)
- 3) Is there a mis-wiring between communication wire and Power wire?
- 4) Is there a mis-wiring between Main PBA and SMPS PBA wire?
- 5) Is the input voltage of SMPS AC in Main PBA (BD151 #2~#3) normal?
- 6) Is the voltage of SMPS DC in Main PBA (CE161(15V), CE175(12V), CE174(5V), CE162(3.3V)) normal?

2. Troubleshooting procedure

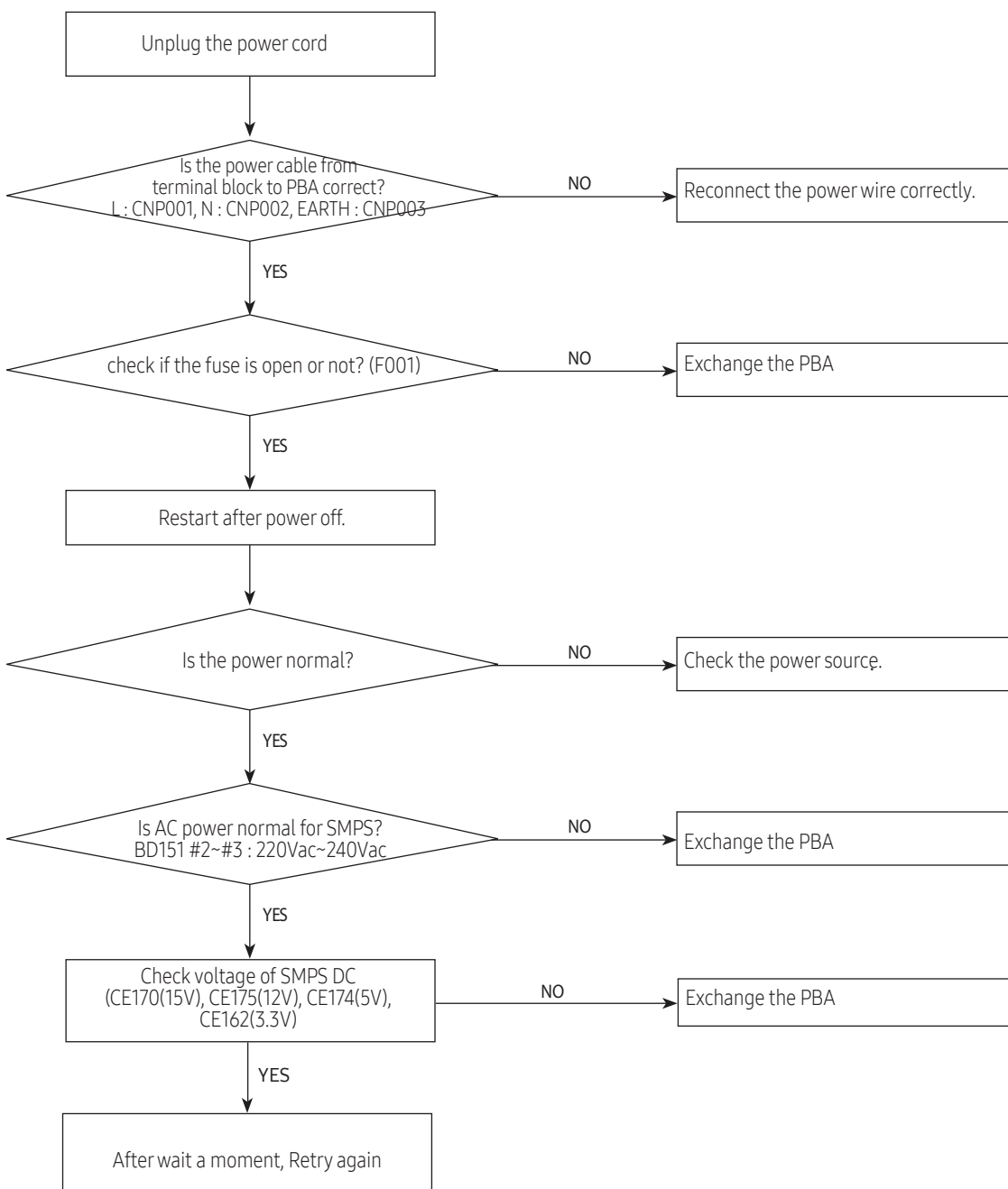

9-2-14 When the Up/Down, Left/Right louver motor does not operate (Initial Diagnosis)(Not displayed)

1. Checklist :

- 1) Is the input power voltage normal?
- 2) Is the Up/Down louver motor properly connected with the connector? (CN800, CN801, CN810)

2. Troubleshooting procedure

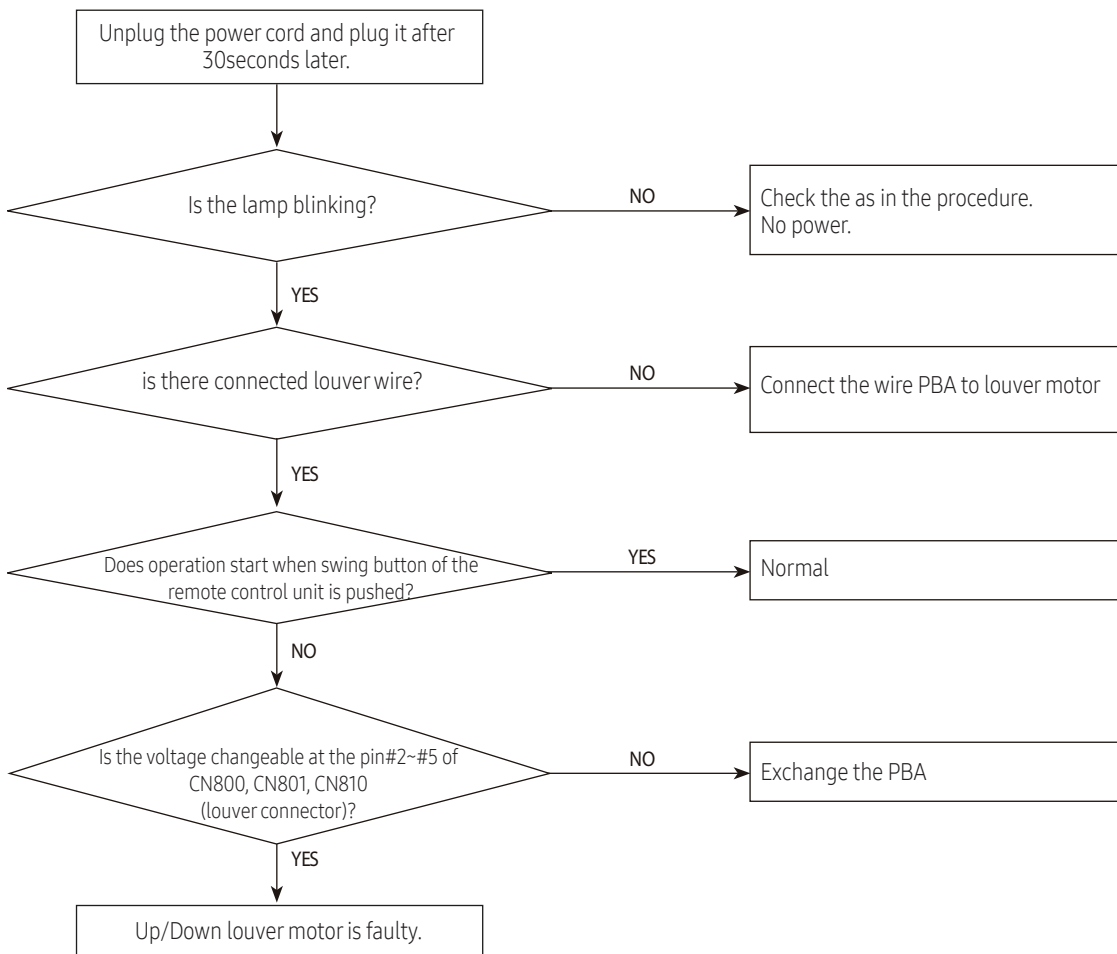

9-2-15 When the remote control is not receiving

1. Checklist :

- 1) Check if the connector was normally assembled.
- 2) Check the battery in remote control
- 3) All the lights out and check again : Change electronic type of light like LED to fluorescent light that can't interfere with the infrared signal.
- 4) Put the set in operation and check the voltage of display PBA
- 5) Replace the display PBA

2. Troubleshooting procedure

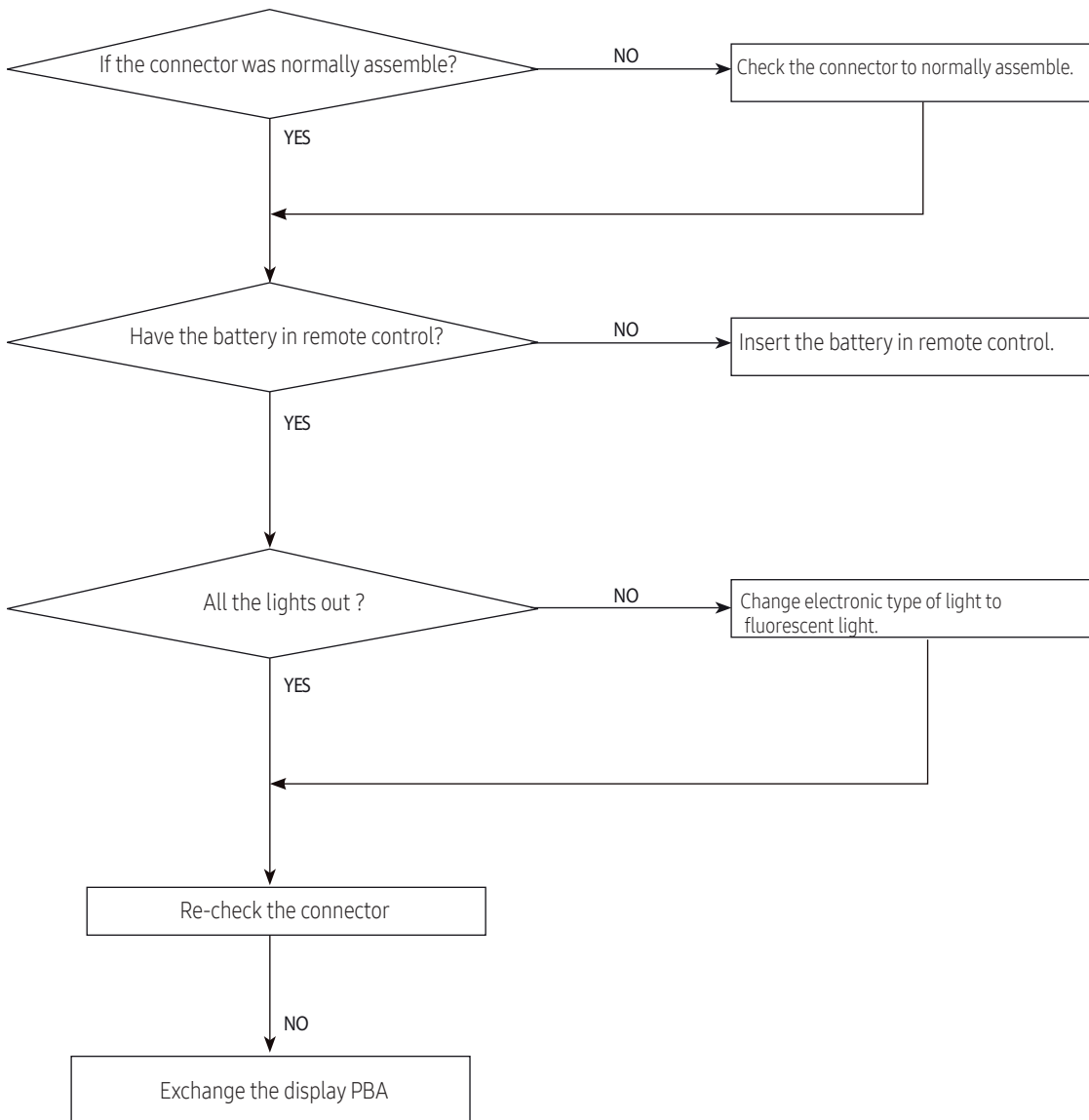

9-2-16 Smart Install error

1. Checklist :

- 1) Check the leakage region.(Use leakage detection liquid or soapy water)
- 2) When leakage region is found from service valve and piping connection re nut part : After the related measures to check the refrigerant supplements and operation.
- 3) If the leakage region is pipe welding part : Weld leakage region after refrigerant gas release.(Brass parts should only apply)
- 4) If the leakage region is surface area (Heat exchanger or pipe welding region is not) : Replace parts.
- 5) Check the PBA Relay
 - Display of indoor unit : Ensure that the operating pilot lamp has been lighted.
 - Ensure that the Relay input voltage of indoor unit PBA is normal.(If the PBA is defective, replace)

2. When the air conditioner is in standby status, use the remote controller to start the Smart Install mode.

- 1) Press the [SET], [Mode], [Power] button simultaneously for 4 seconds.
 - Smart Install mode can be operated only with the supplied remote controller.
 - During the Smart install mode procedure, remote controller cannot be operated.

3. Troubleshooting procedure

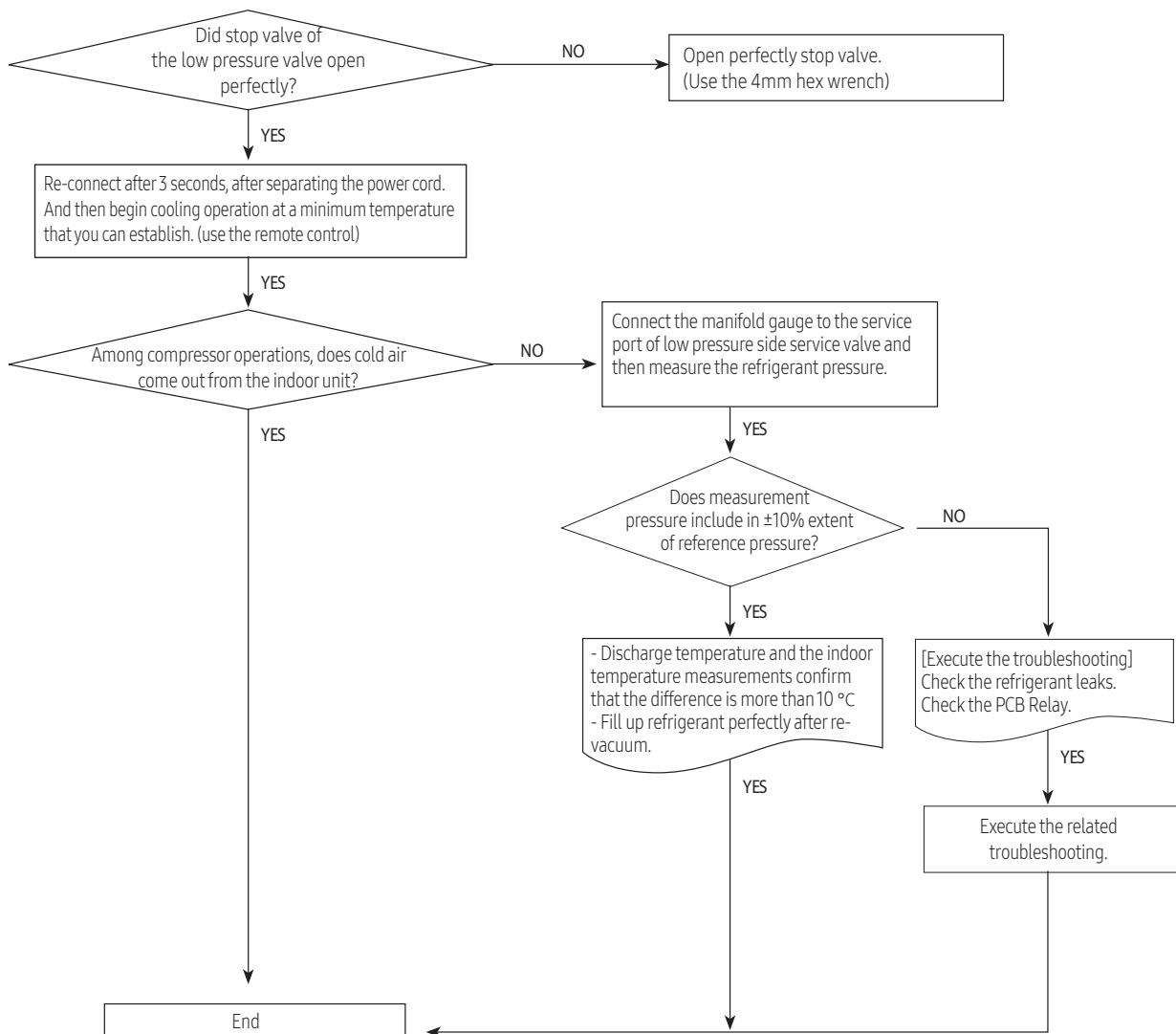

9-2-17 EEV or VALVE CLOSE error (C422)

Indoor display

7-SEG DISPLAY	DESCRIPTION
C422	EEV OR VALVE CLOSE ERROR-SELF DIAGNOSIS

Outdoor display



● LED ON ● LED BLINKING ○ LED OFF

1. failure cause

- 1) Check for leakage using leakage detection liquid or soapy water.
- 2) If a leak is found in the service valve or piping connection flare nut part, take the relevant action and recheck the refrigerant and operation.
- 3) If the leakage part is a PIPE welding part, rewelding is performed after release of refrigerant gas.
- 4) If the leakage part is found on the surface other than the heat exchanger or PIPE welding part, replace the part
- 5) PBA Check
 - Check if an error has occurred in the indoor display.
 - Check if the input voltage of the indoor PBA is normal and replace the PBA if there is any abnormality.

6) Troubleshooting procedure

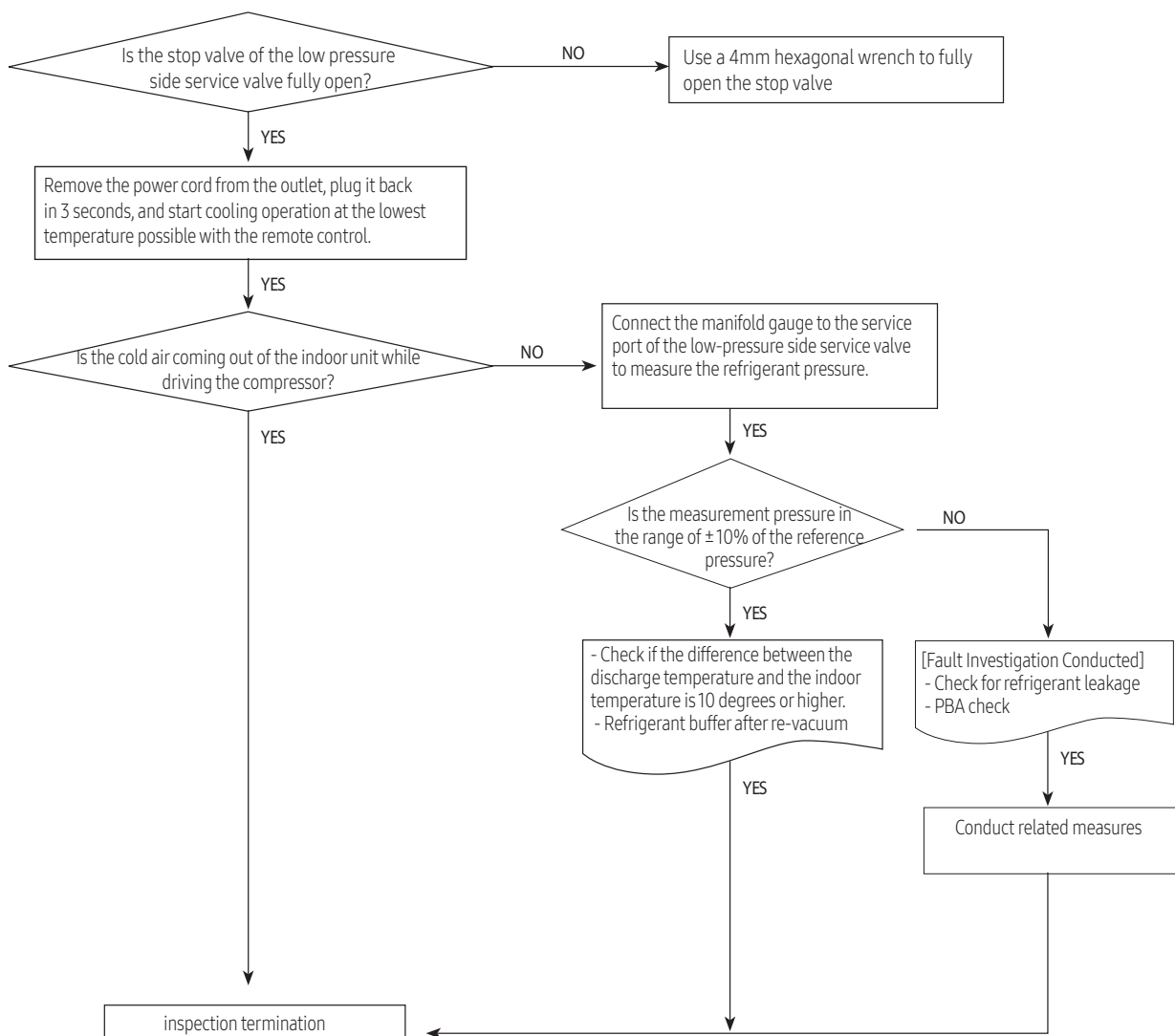

9-2-18 Outdoor fan motor errors

Indoor display

7-SEG DISPLAY	DESCRIPTION
C383	FAN CONTROLLER PCB OVERHEAT
C478	FAN IPM OVER CURRENT(O.C) ERROR
C489	FAN VLIMIT / Current Limit
C446	FAN STARTING ERROR
C447	FAN WIRE MISSING ERROR
C455	FAN HEATSINK OVER TEMP ERROR
C493	FAN CURRENT SENSOR ERROR
C499	FAN HEATSINK SENSOR ERROR

Outdoor display



1. Checklist :

- 1) Are the input power voltage and the power connection correct?
- 2) Is the motor wire connected to the outdoor PBA correctly?
- 3) Is there no assembly error or non-assembly in the terminal of motor wire connector?
- 4) Is there no obstacle in the surroundings of motor and propeller?

2. Troubleshooting procedure

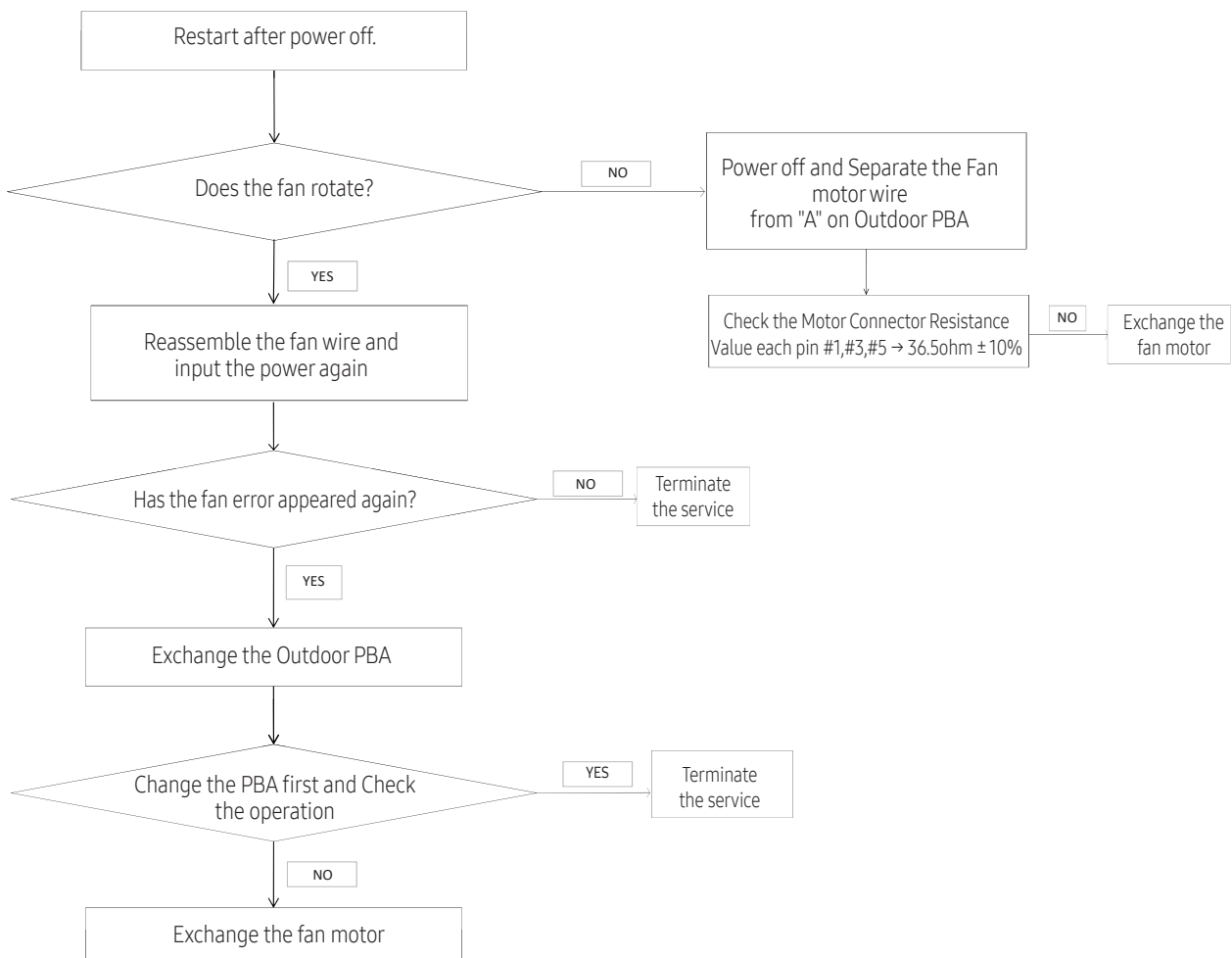

9-2-19 Set option error

Indoor display

7-SEG DISPLAY	DESCRIPTION
C163	Set option error

● LED ON ◐ LED BLINKING ○ LED OFF

1. Checklist :

- 1) Is the indoor units fan motor properly connected with the connector(CN900)?
- 2) Is the AC voltage correct?

2. Troubleshooting procedure

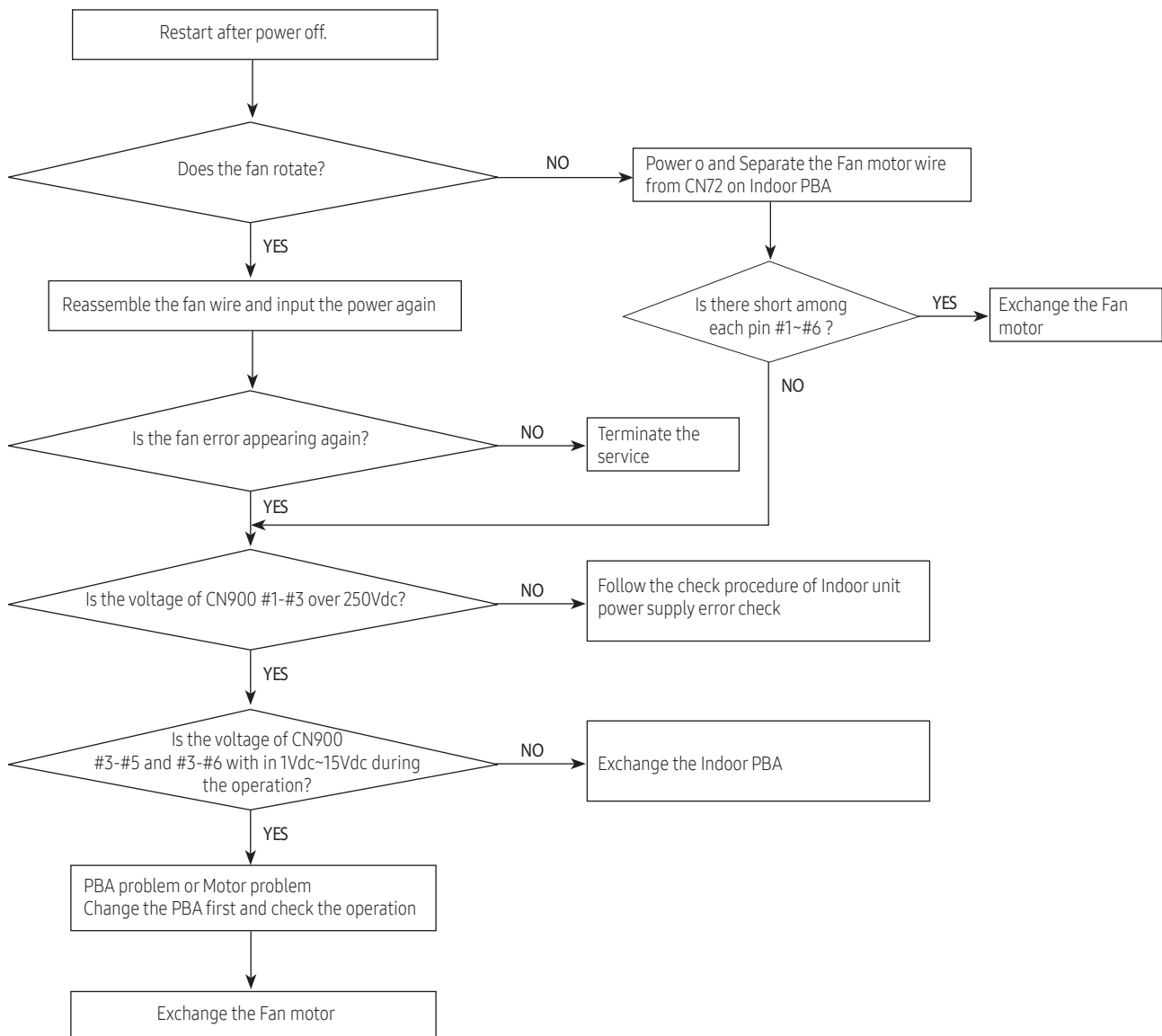

9-2-20 COMP DOWN DUE TO HIGH PRESSURE SWITCH OPEN ERROR

Indoor display

7-SEG DISPLAY	DESCRIPTION
C507	COMP DOWN DUE TO HIGH PRESSURE SWITCH OPEN ERROR

Outdoor display

●	◐	○	COMP DOWN DUE TO HIGH PRESSURE SWITCH OPEN ERROR
---	---	---	--

● LED ON ◐ LED BLINKING ○ LED OFF

1. Checklist :

- 1) Is the sensor connected correctly?

2. Troubleshooting procedure

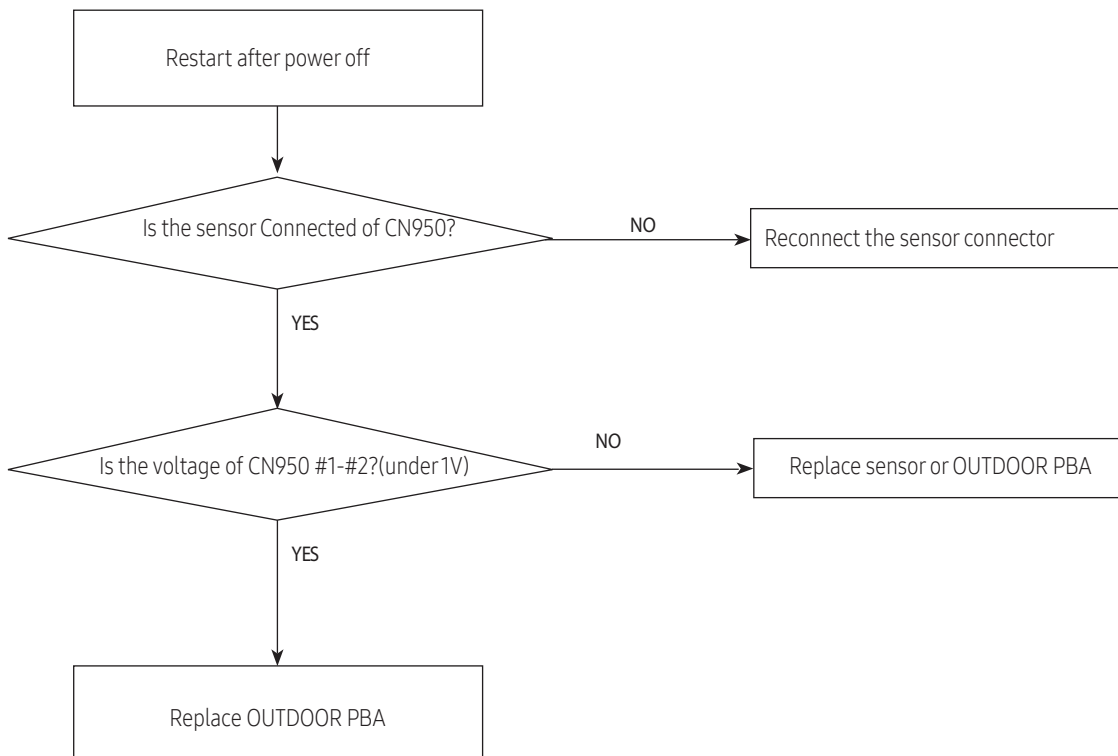



9-2-21 OTP error

Indoor display

7-SEG DISPLAY	DESCRIPTION
C590	EEPROM DATA ERROR(COMP MICOM - MAIN MICOM)
C594	EEPROM DATA ERROR(FAN MICOM - MAIN MICOM)

Outdoor display

			OTP error EEPROM Data Errors(Main Micom-Comp Micom or Errors(Main Micom-Fan Micom)
---	---	---	--

● LED ON ◐ LED BLINKING ○ LED OFF

1. Checklist :

- 1) Is there a short around micom?
- 2) Did you download or insert EEPROM IC, after changing outdoor PBA?

2. Troubleshooting procedure

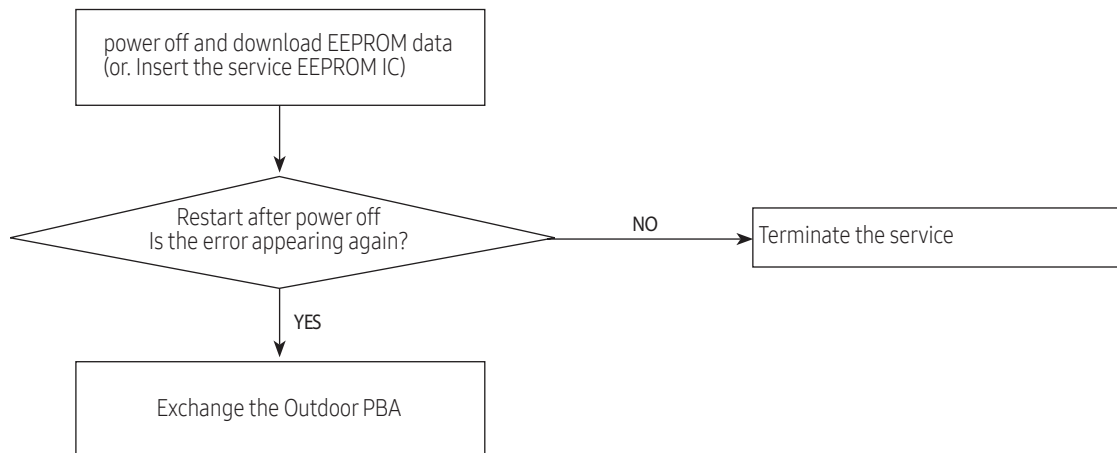

9-2-22 Fan starting error

Indoor display

7-SEG DISPLAY	DESCRIPTION
C446	Fan starting error

Outdoor display

●	○	○	Fan starting error
---	---	---	--------------------

● LED ON ● LED BLINKING ○ LED OFF

1. Checklist :

- 1) Is the connection of cable for the fan?
- 2) Is the fan wire connected clockwise? U(RED)-V(WHT)-W(BLK)
- 3) Is the interphase resistance of the fan normal?

2. Troubleshooting procedure

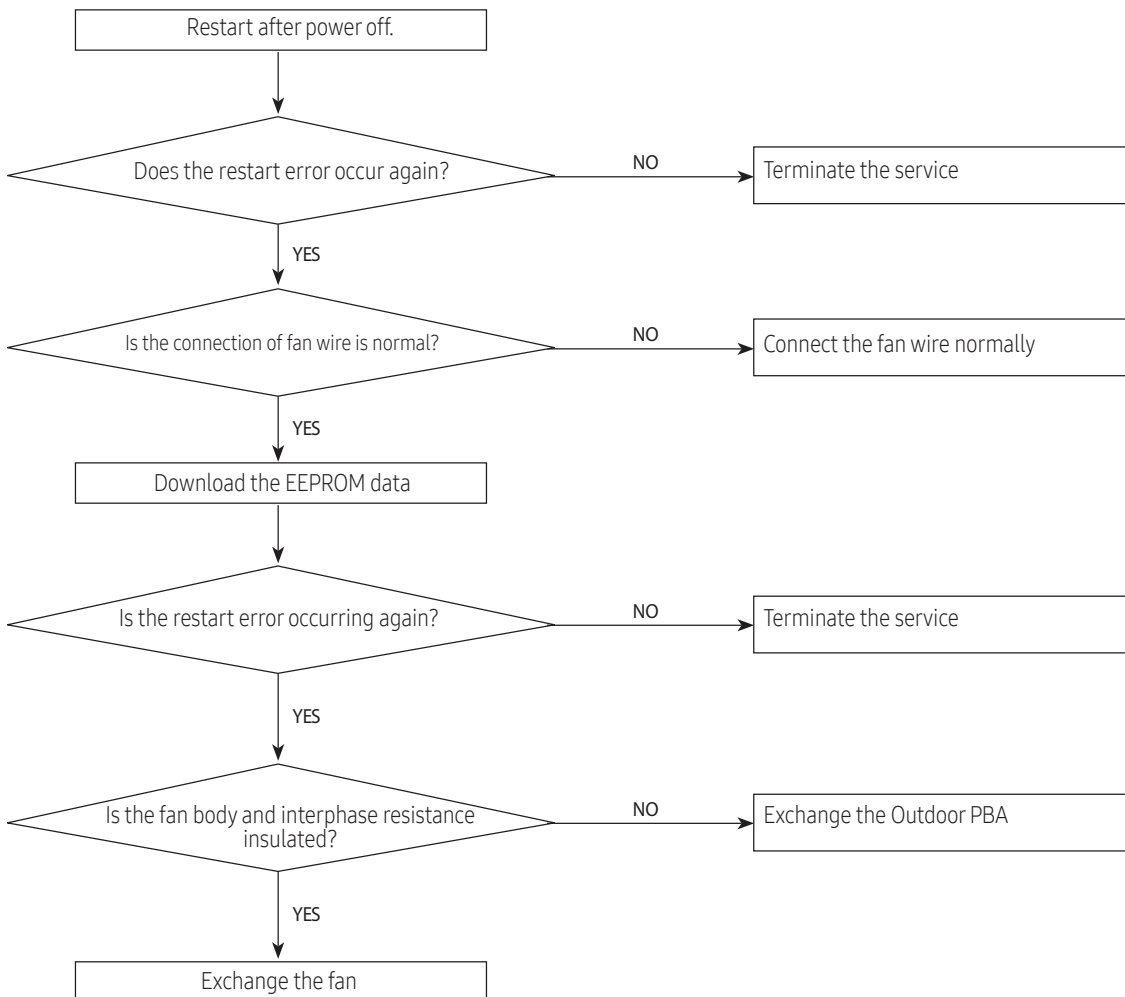

9-2-23 FAN IPM OVER CURRENT(O.C) ERROR

Indoor display

7-SEG DISPLAY	DESCRIPTION
C478	FAN IPM OVER CURRENT(O.C) ERROR

Outdoor display

●	○	○	FAN IPM OVER CURRENT(O.C) ERROR
---	---	---	---------------------------------

● LED ON ◐ LED BLINKING ○ LED OFF

1. Checklist :

- 1) Is the IPM Shunt resistance value correct? Check if the resistor is open
- 2) Is the condition of the surrounding temperature leading to an abnormal overload?
- 3) Is there any problem like the temperature sensor separation or measurement value error?
- 4) Is the interphase resistance of FAN normal?

2. Troubleshooting procedure

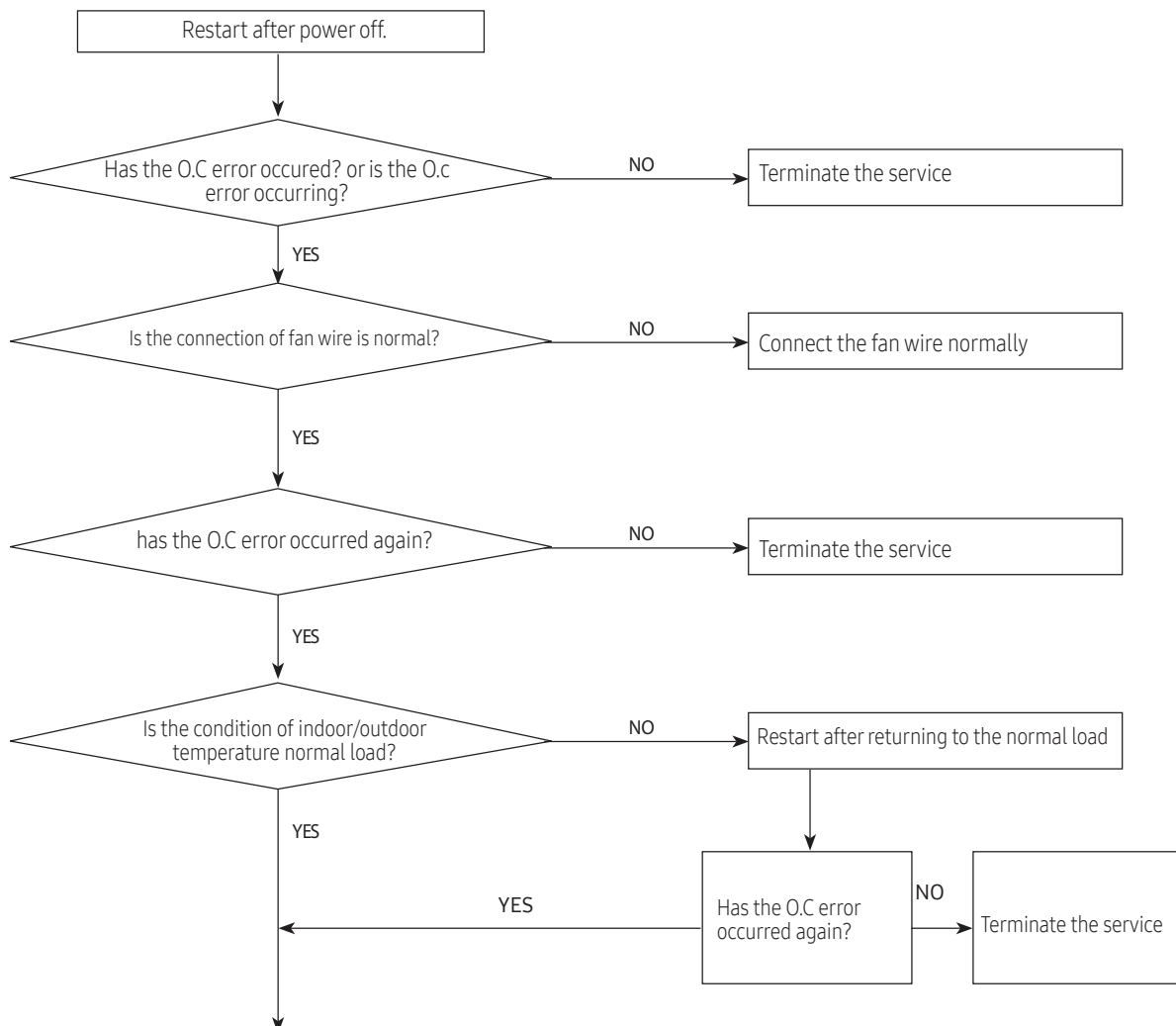

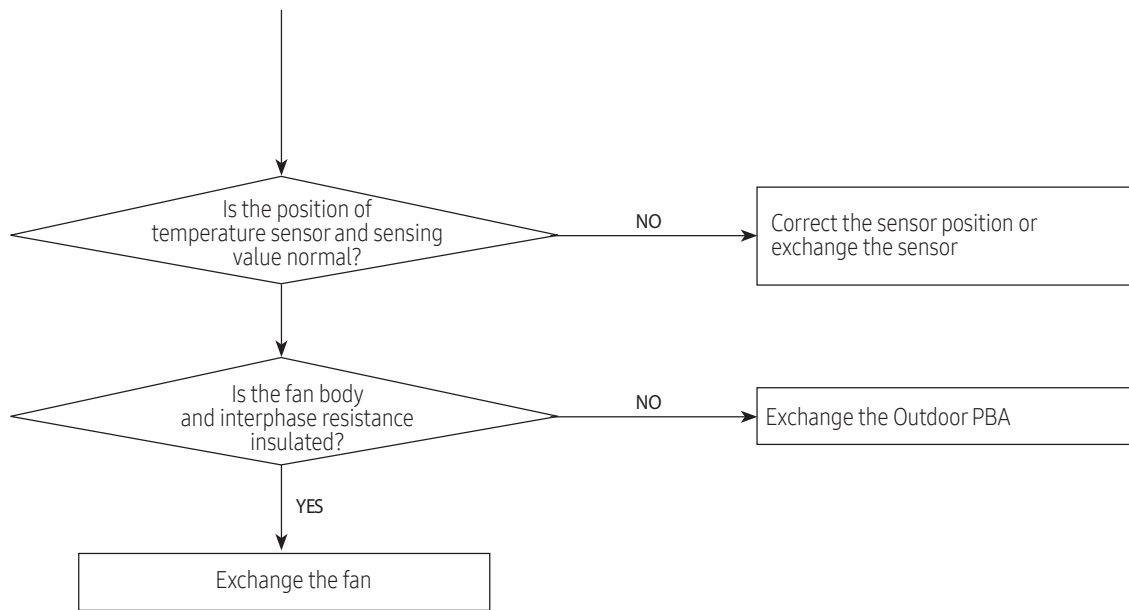

9-2-24 AC INPUT VOLTAGE SENSOR ERROR

Indoor display

7-SEG DISPLAY	DESCRIPTION
C488	AC INPUT VOLTAGE SENSOR ERROR

Outdoor display

●	●	●	AC INPUT VOLTAGE SENSOR ERROR
---	---	---	-------------------------------

● LED ON ● LED BLINKING ○ LED OFF

1. Checklist :

- 1) Is the voltage value of bridge diode(=BD051)?
- 2) Is the voltage value of resistance(=R105)?

2. Troubleshooting procedure

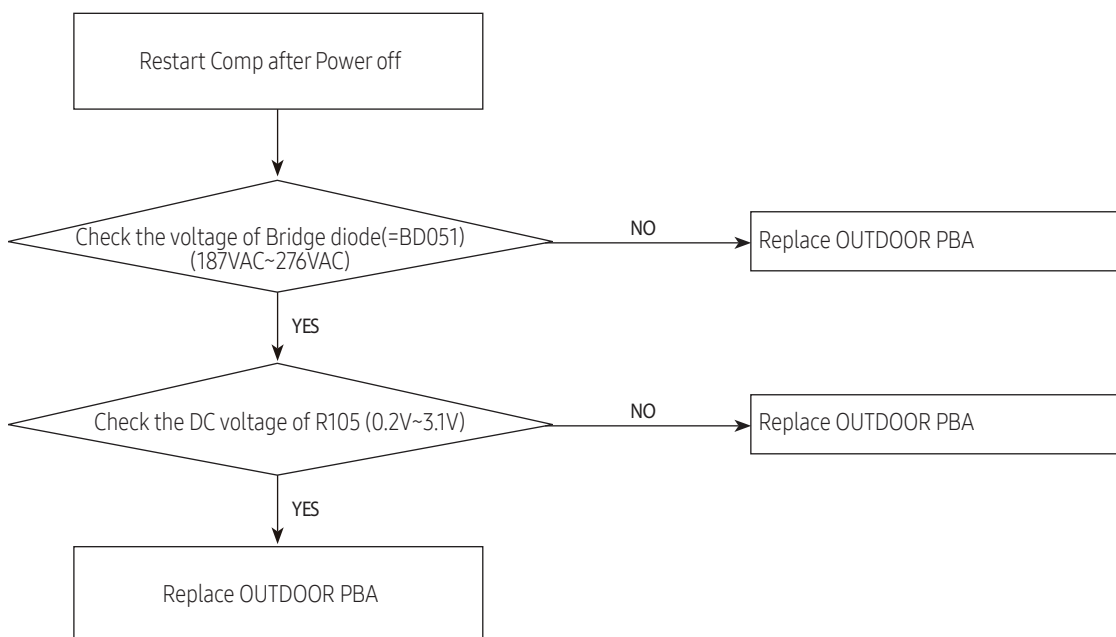

9-2-25 COMP DC-LINK VOLTAGE SENSOR ERROR

Indoor display

7-SEG DISPLAY	DESCRIPTION
C469	COMP DC-LINK VOLTAGE SENSOR ERROR

Outdoor display



LED ON
 LED BLINKING
 LED OFF

1. Checklist :

- 1) What is the voltage value of DC LINK Capacitor?
- 2) What is the voltage value of resistance(=R101)?

2. Troubleshooting procedure

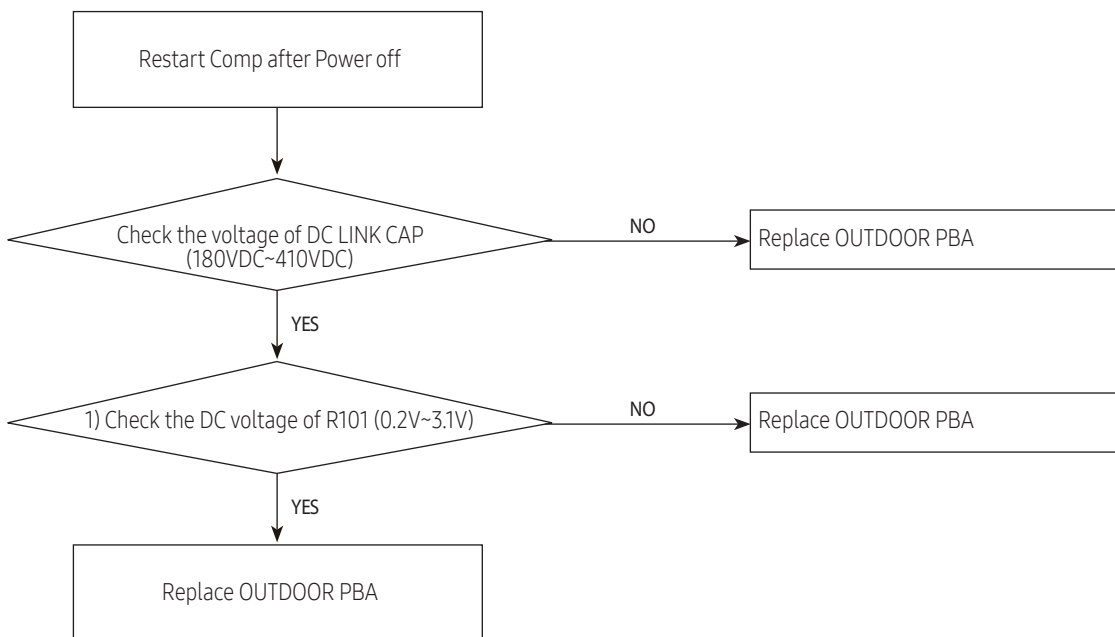

9-2-26 FAN DC-LINK VOLTAGE SENSOR ERROR

Indoor display

7-SEG DISPLAY	DESCRIPTION
C496	FAN DC-LINK VOLTAGE SENSOR ERROR

Outdoor display

●	●	●	FAN DC-LINK VOLTAGE SENSOR ERROR
---	---	---	----------------------------------

● LED ON ● LED BLINKING ○ LED OFF

1. Checklist :

- 1) What is the voltage value of DC LINK Capacitor?
- 2) What is the voltage value of resistance(=R101)?

2. Troubleshooting procedure

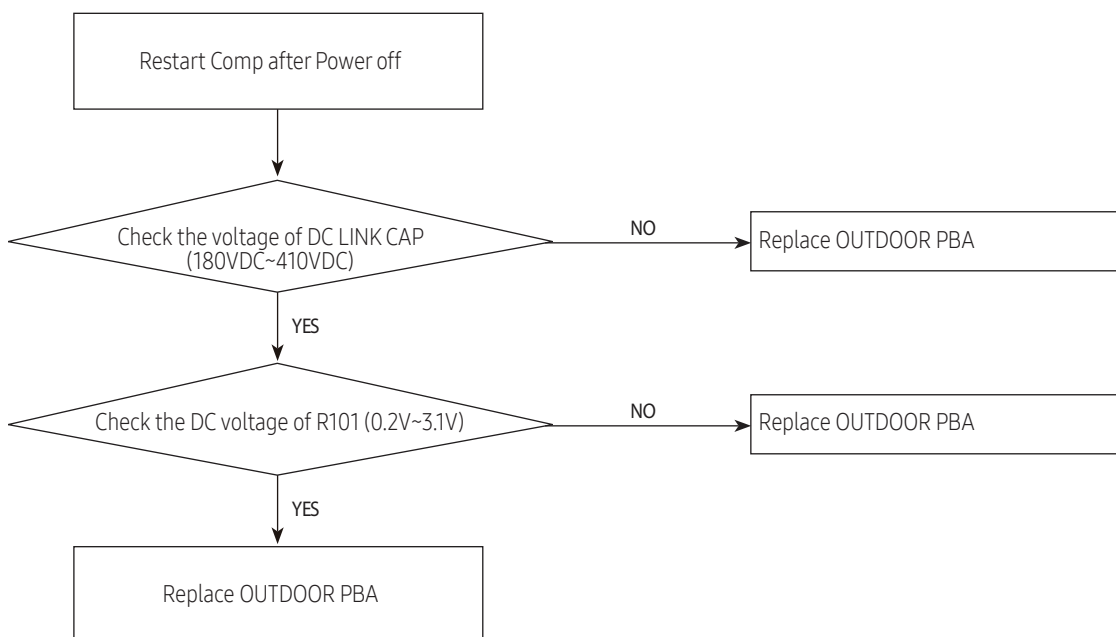

9-2-27 DC-LINK VOLTAGE UNDER/OVER ERROR

Indoor display

7-SEG DISPLAY	DESCRIPTION
C466	COMP DC-LINK VOLTAGE UNDER/OVER ERROR
C486	FAN DC-LINK VOLTAGE UNDER/OVER ERROR

Outdoor display

○	●	◐	COMP DC-LINK VOLTAGE UNDER/OVER ERROR FAN DC-LINK VOLTAGE UNDER/OVER ERROR
---	---	---	---

● LED ON ◐ LED BLINKING ○ LED OFF

1. Checklist :

- 1) What is the voltage value of DC LINK Capacitor?
- 2) Is one of the components broken?(F001, BD051)
- 3) What is the voltage value of the power terminal block?

2. Troubleshooting procedure

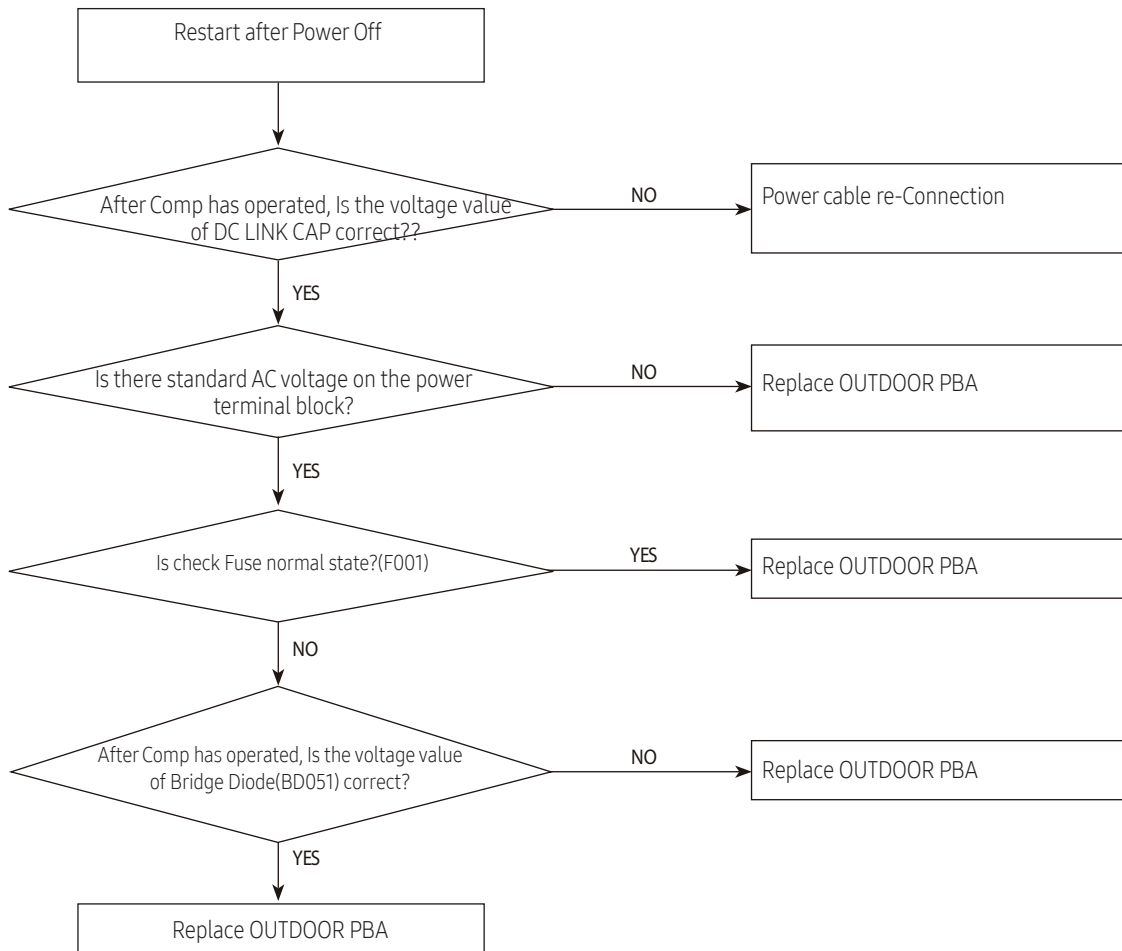

9-2-28 COMP CONTROLLER PCB OVERHEAT

Indoor display

7-SEG DISPLAY	DESCRIPTION
C381	COMP CONTROLLER PCB OVERHEAT

Outdoor display

  	COMP CONTROLLER PCB OVERHEAT
---	------------------------------

 LED ON  LED BLINKING  LED OFF

1. Checklist :

- 1) Is the resistance value of PTC401?

2. Troubleshooting procedure

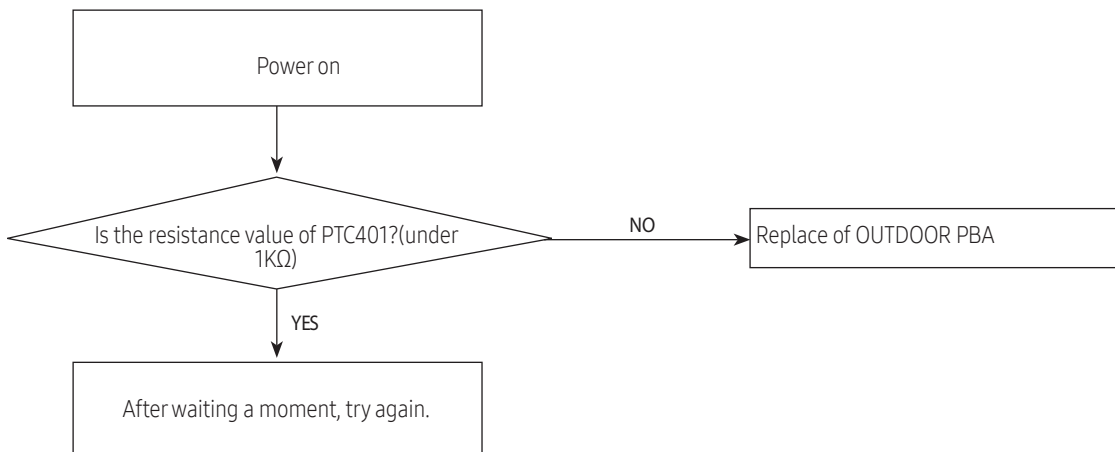

9-2-29 FAN CONTROLLER PCB OVERHEAT

Indoor display

7-SEG DISPLAY	DESCRIPTION
C383	FAN CONTROLLER PCB OVERHEAT

Outdoor display

●	○	○	FAN CONTROLLER PCB OVERHEAT
---	---	---	-----------------------------

● LED ON ◐ LED BLINKING ○ LED OFF

1. Checklist :

- 1) Is the voltage value of CE904 or CE764?
- 2) Is the resistance value of PTC901 or PTC761?

2. Troubleshooting procedure

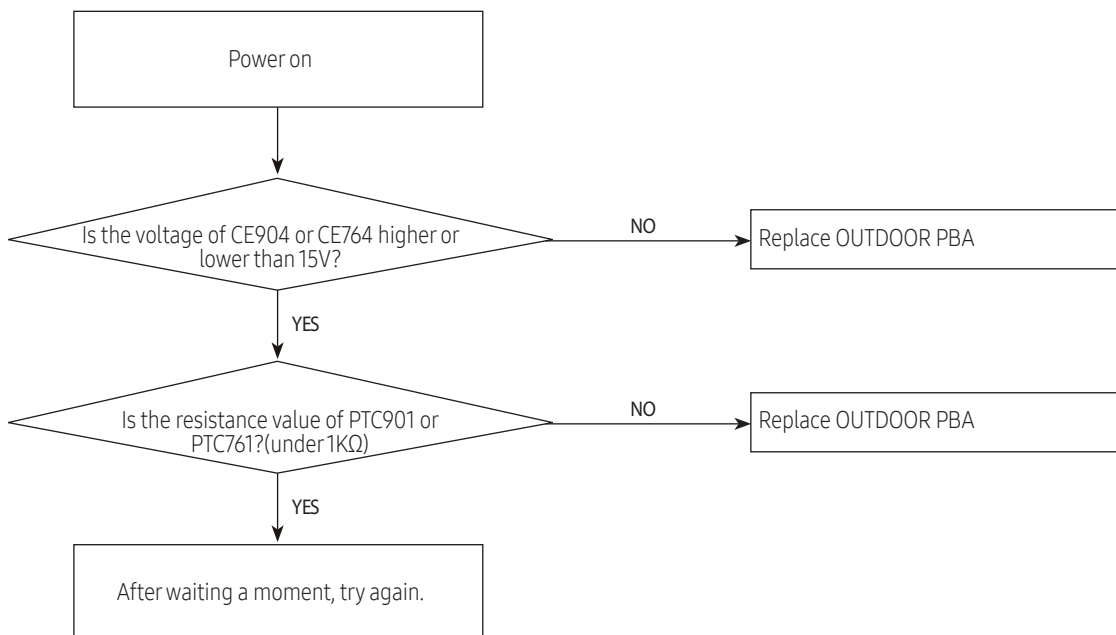

9-2-30 COMP HEATSINK SENSOR ERROR

Indoor display

7-SEG DISPLAY	DESCRIPTION
C474	COMP HEATSINK SENSOR ERROR

Outdoor display

●	●	●	COMP HEATSINK SENSOR ERROR
---	---	---	----------------------------

● LED ON ● LED BLINKING ○ LED OFF

1. Checklist :

- 1) Is version of EEPROM data correct?
- 2) Is the voltage value of IPM Pin(14, 16) or IPM Pin(2, 7)?

2. Troubleshooting procedure

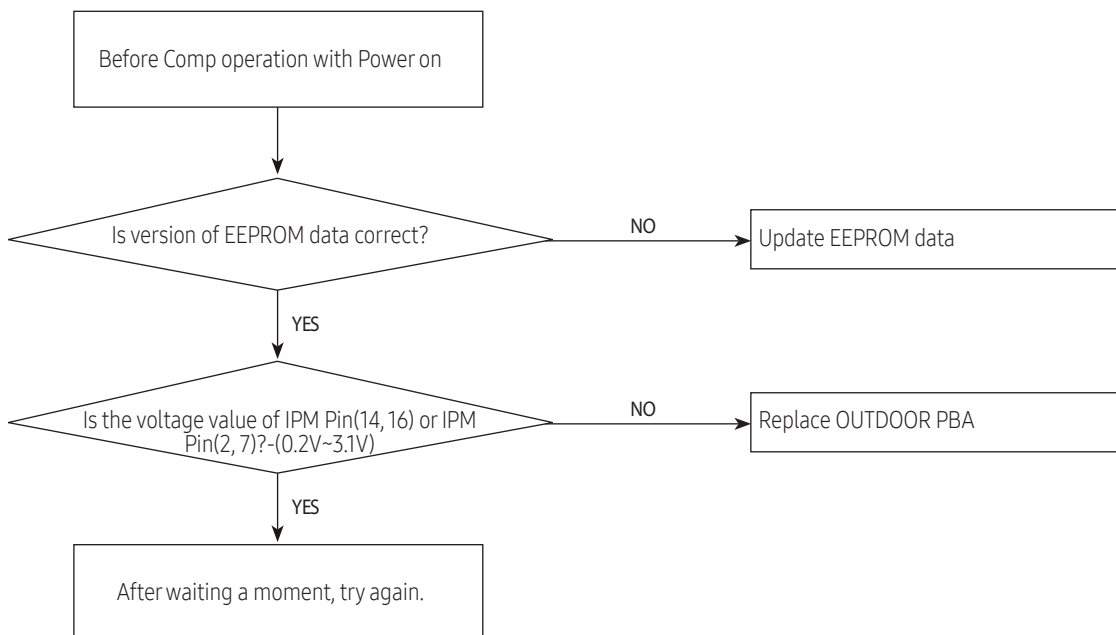

9-2-31 FAN HEATSINK SENSOR ERROR

Indoor display

7-SEG DISPLAY	DESCRIPTION
C499	FAN HEATSINK SENSOR ERROR

Outdoor display

●	○	○	FAN HEATSINK SENSOR ERROR
---	---	---	---------------------------

● LED ON ◐ LED BLINKING ○ LED OFF

1. Checklist :

- 1) Is version of EEPROM data correct?
- 2) Is the voltage value of IPM Pin(1, 11)?

2. Troubleshooting procedure

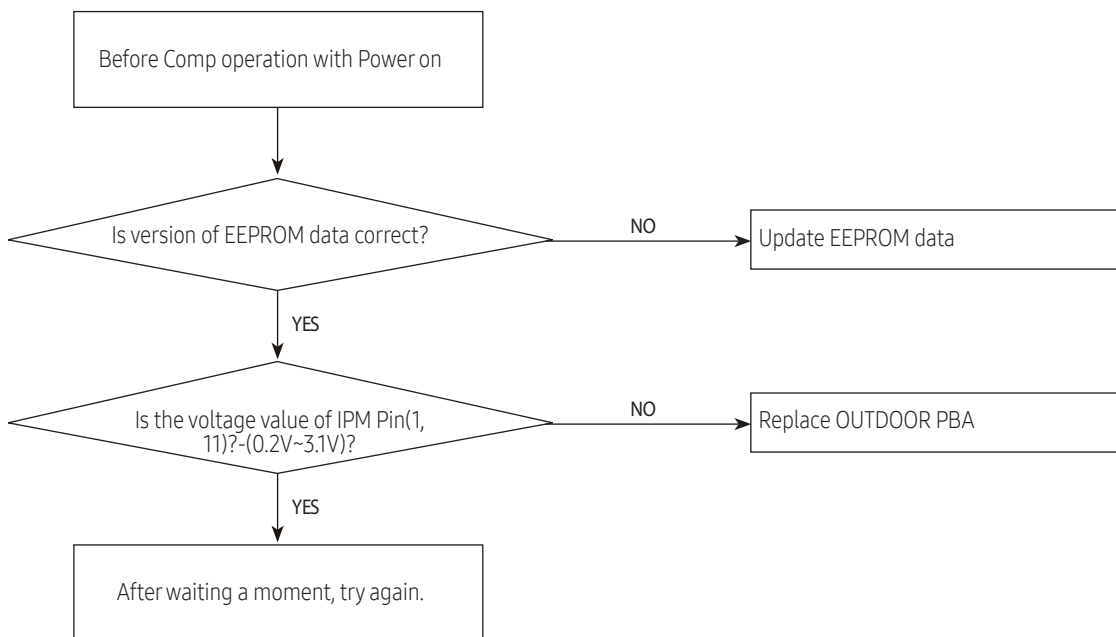

9-2-32 FAN HEATSINK OVER TEMP ERROR

Indoor display

7-SEG DISPLAY	DESCRIPTION
C455	FAN HEATSINK OVER TEMP ERROR

Outdoor display

●	○	○	FAN HEATSINK OVER TEMP ERROR
---	---	---	------------------------------

● LED ON ◐ LED BLINKING ○ LED OFF

1. Checklist :

- 1) Check the assembly between heat sink and IPM
- 2) Did the temperature of the IPM rise to above 95 C?

2. Troubleshooting procedure

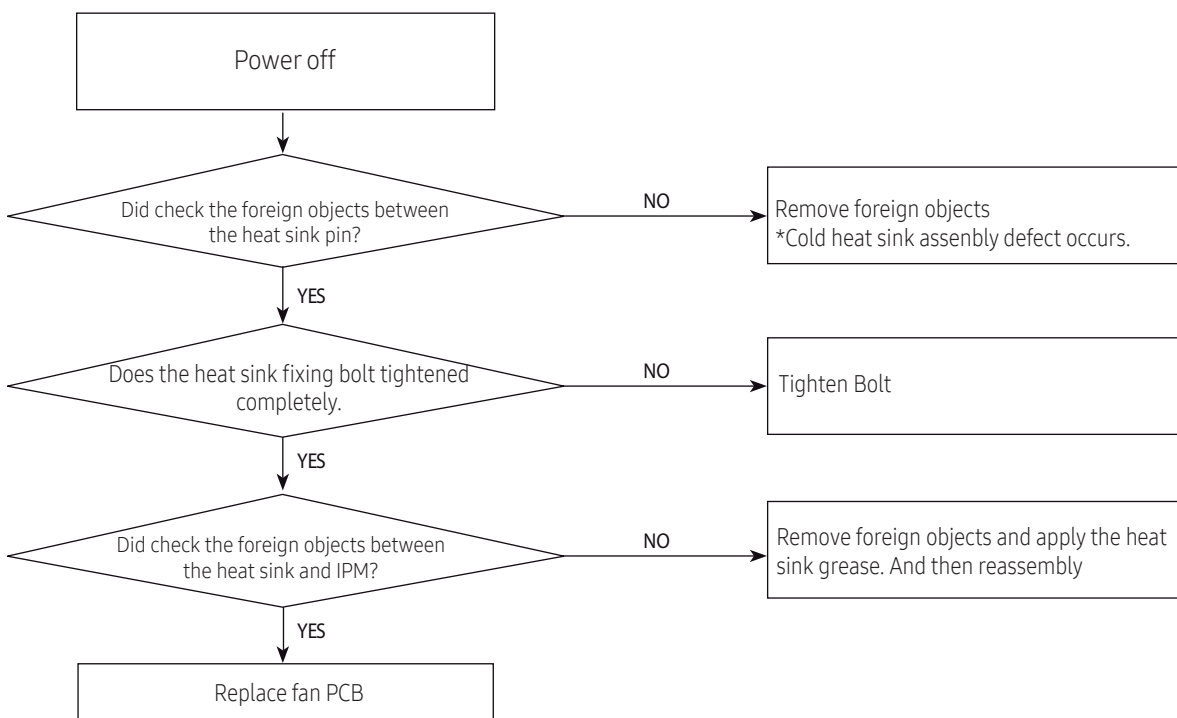

9-2-33 COMP HEATSINK OVER TEMP ERROR

Indoor display

7-SEG DISPLAY	DESCRIPTION
C500	COMP HEATSINK OVER TEMP ERROR

Outdoor display



LED ON
 LED BLINKING
 LED OFF

1. Checklist :

- 1) Check the assembly between heat sink and IPM
- 2) Did the temperature of the IPM rise to above 95 C?

2. Troubleshooting procedure

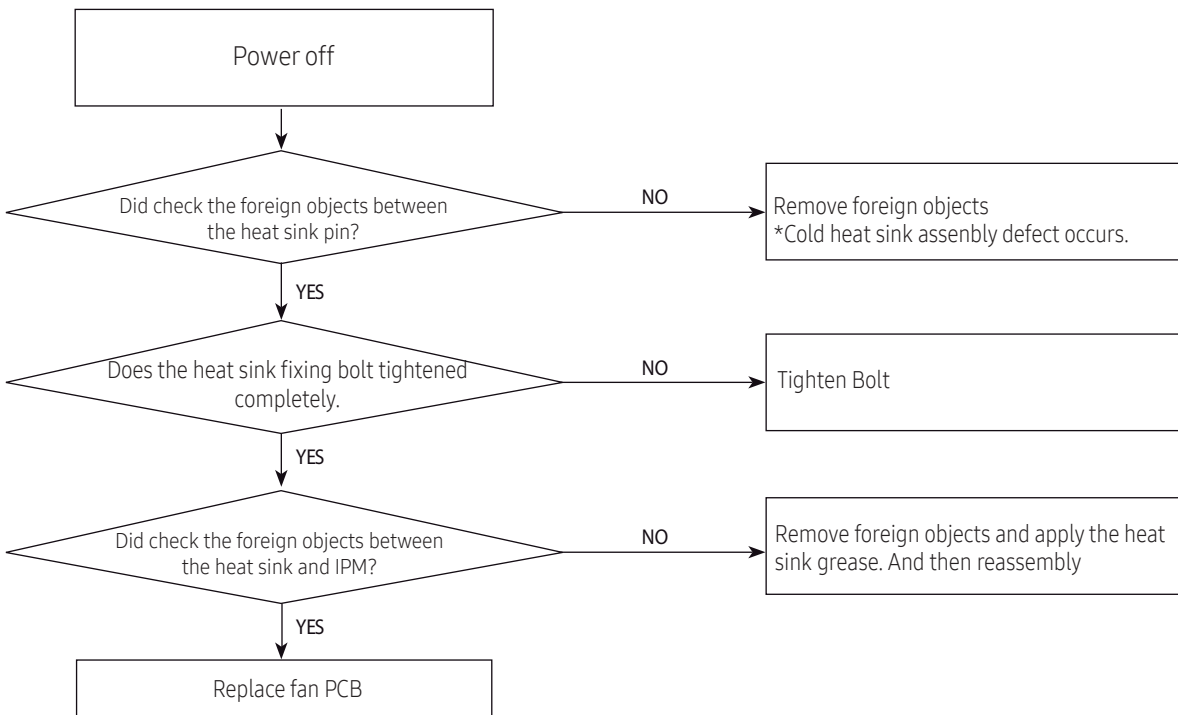

9-2-34 COMP CURRENT SENSOR ERROR

Indoor display

7-SEG DISPLAY	DESCRIPTION
C468	COMP CURRENT SENSOR ERROR

Outdoor display

●	●	●	COMP CURRENT SENSOR ERROR
---	---	---	---------------------------

● LED ON ● LED BLINKING ○ LED OFF

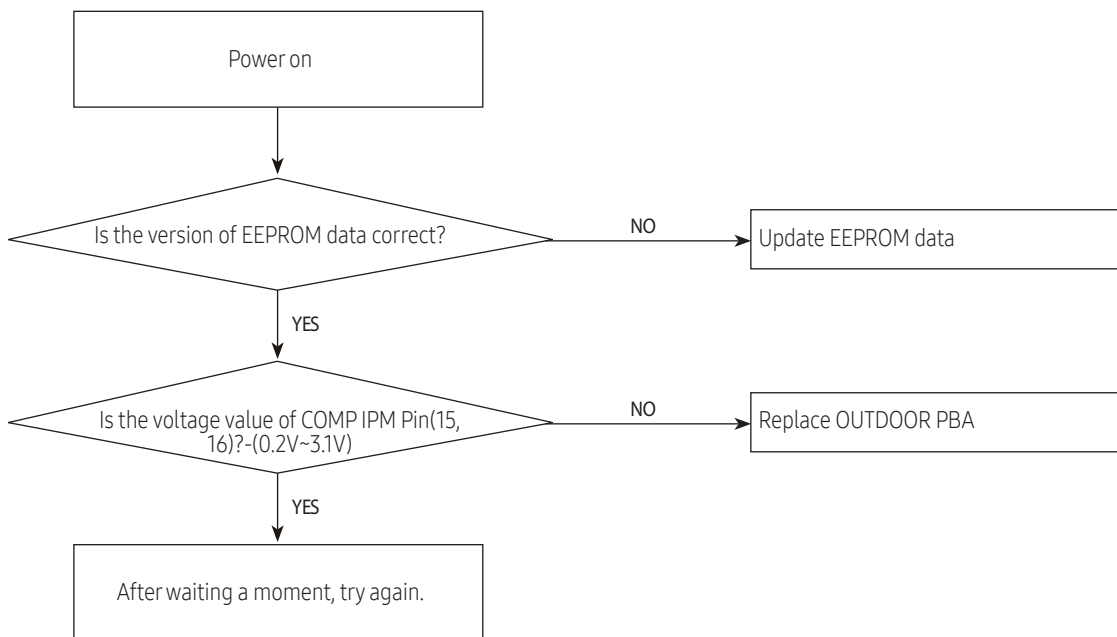



9-2-35 FAN CURRENT SENSOR ERROR

Indoor display

7-SEG DISPLAY	DESCRIPTION
C493	FAN CURRENT SENSOR ERROR

Outdoor display

			FAN CURRENT SENSOR ERROR
---	---	---	--------------------------

● LED ON ◐ LED BLINKING ○ LED OFF

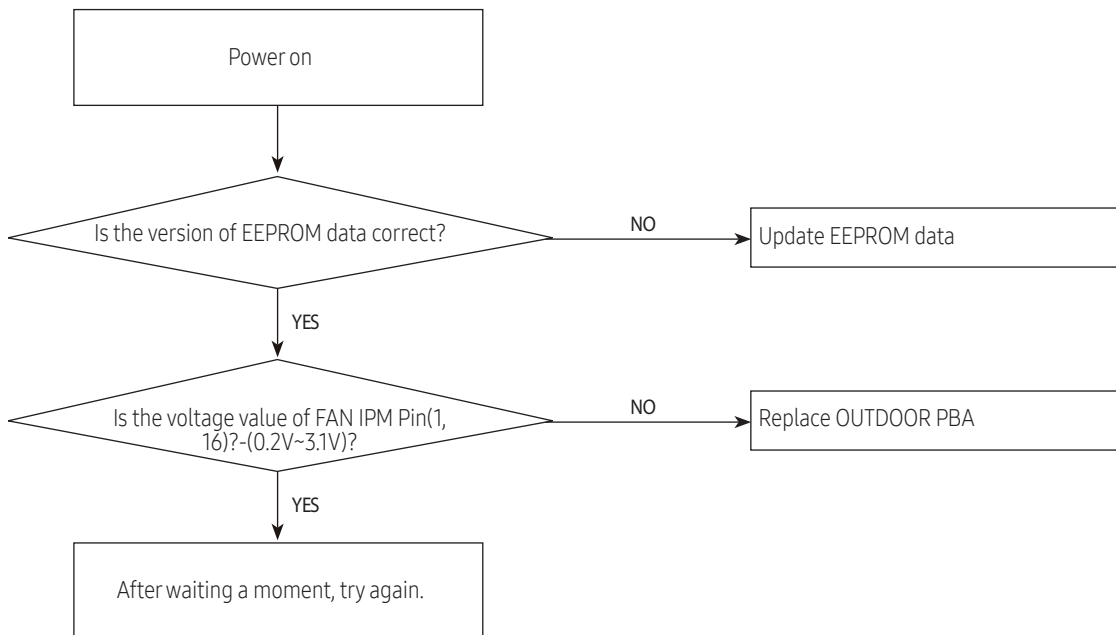

9-2-36 COMP V_LIMIT/I_LIMIT ERROR

Indoor display

7-SEG DISPLAY	DESCRIPTION
C465	COMP V_LIMIT/I_LIMIT ERROR

Outdoor display

●	●	○	COMP V_LIMIT/I_LIMIT ERROR
---	---	---	----------------------------

● LED ON ◐ LED BLINKING ○ LED OFF

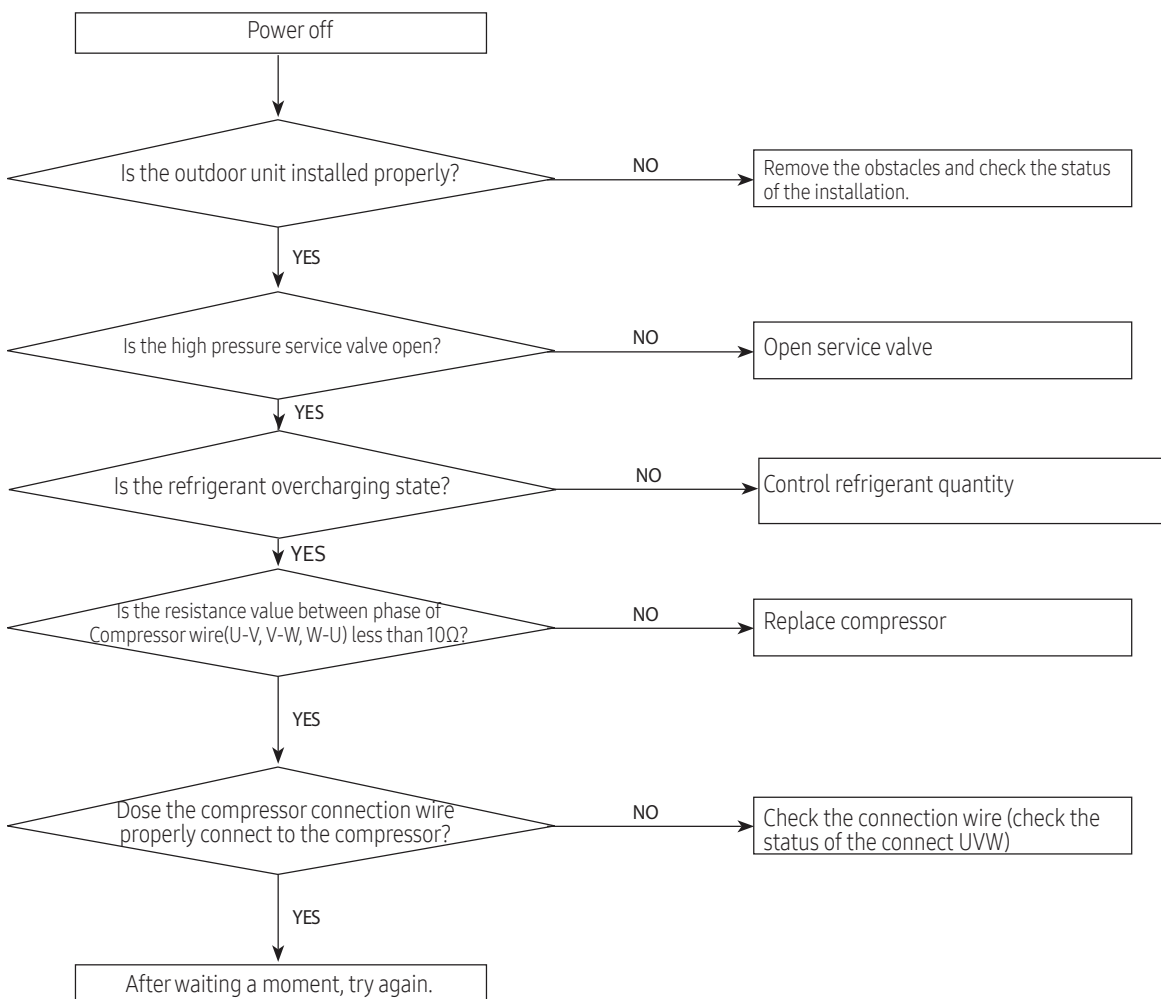

9-2-37 FAN V_LIMIT / I_LIMIT ERROR

Indoor display

7-SEG DISPLAY	DESCRIPTION
C489	FAN V_LIMIT / I_LIMIT ERROR

Outdoor display

●	○	○	FAN V_LIMIT / I_LIMIT ERROR
---	---	---	-----------------------------

● LED ON ● LED BLINKING ○ LED OFF

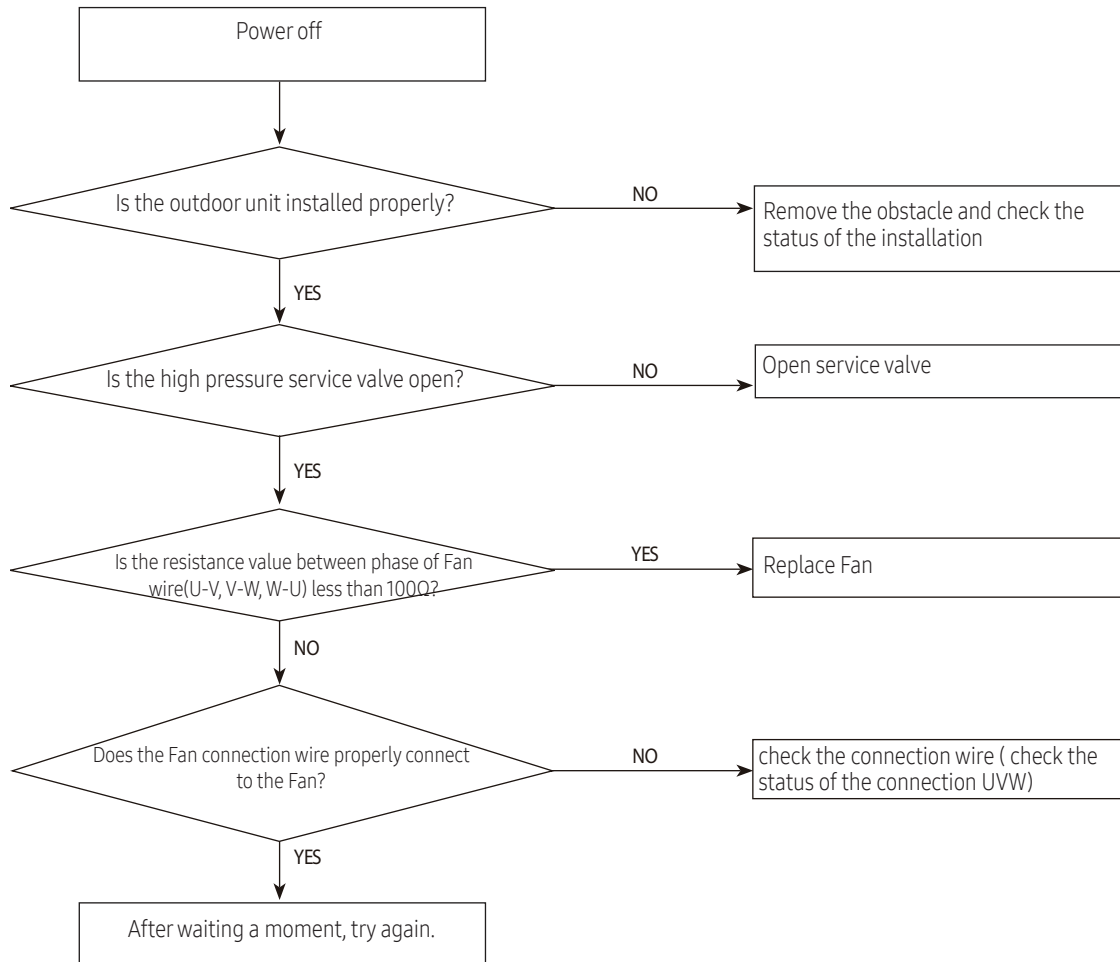

9-2-38 INPUT CURRENT SENSOR ERROR

Indoor display

7-SEG DISPLAY	DESCRIPTION
C485	INPUT CURRENT SENSOR ERROR

Outdoor display

●	●	●	INPUT CURRENT SENSOR ERROR
---	---	---	----------------------------

● LED ON ● LED BLINKING ○ LED OFF

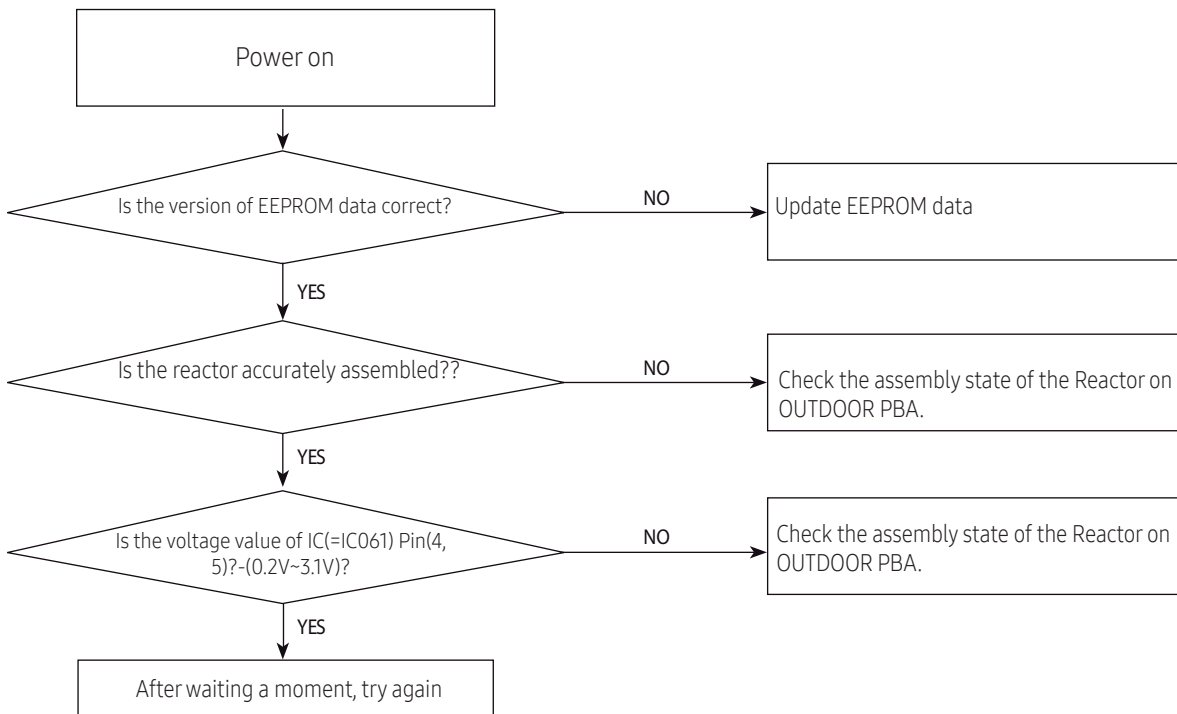

9-2-39 PFC OVER LOAD ERROR

Indoor display

7-SEG DISPLAY	DESCRIPTION
C484	PFC OVER LOAD ERROR

Outdoor display

○	●	◐	PFC OVER LOAD ERROR
---	---	---	---------------------

● LED ON ◐ LED BLINKING ○ LED OFF

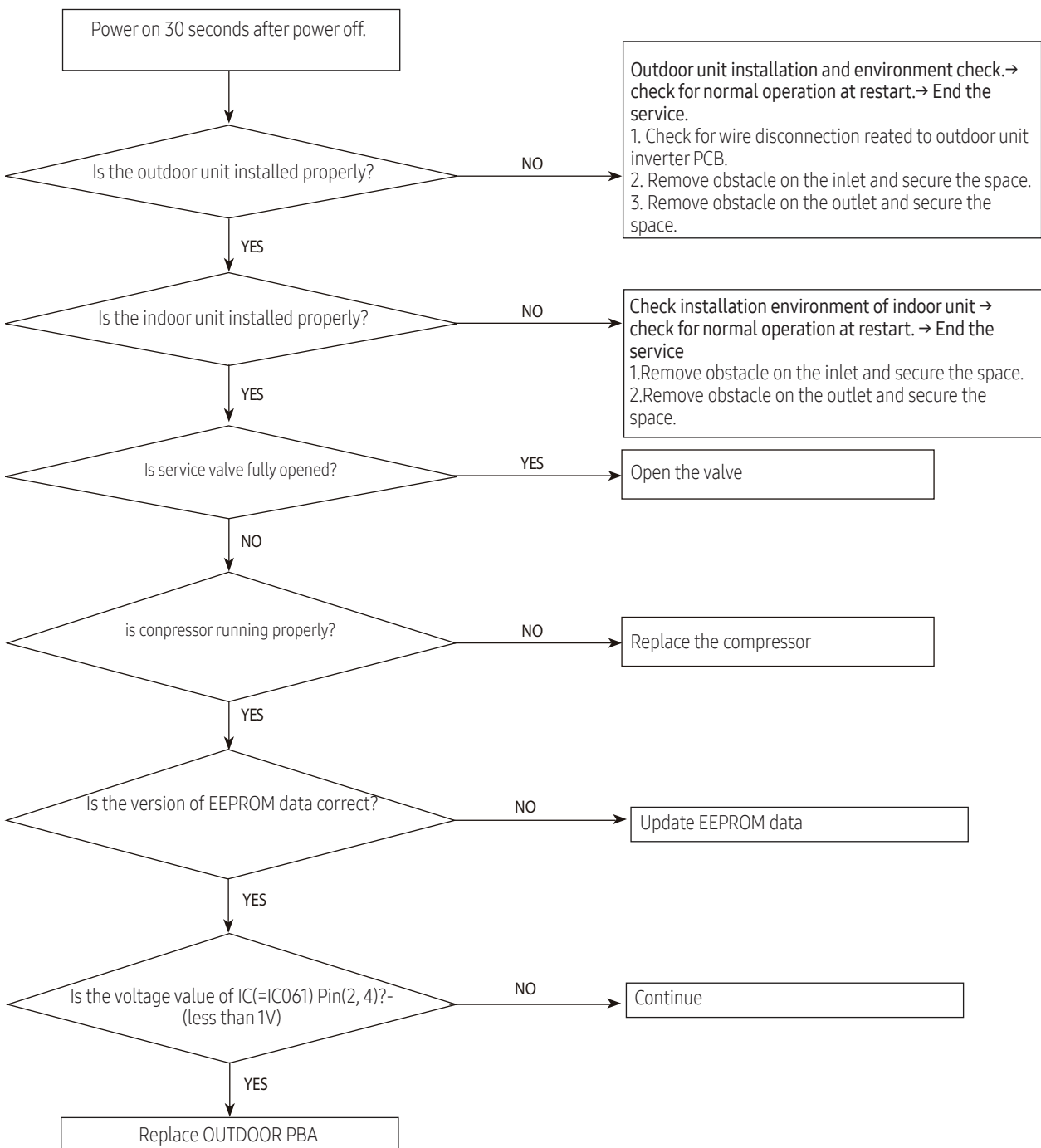

9-2-40 OVER VOLTAGE PROTECTION ERROR

Indoor display

7-SEG DISPLAY	DESCRIPTION
C483	OVER VOLTAGE PROTECTION ERROR

Outdoor display

  	OVER VOLTAGE PROTECTION ERROR
---	-------------------------------

● LED ON ◐ LED BLINKING ○ LED OFF

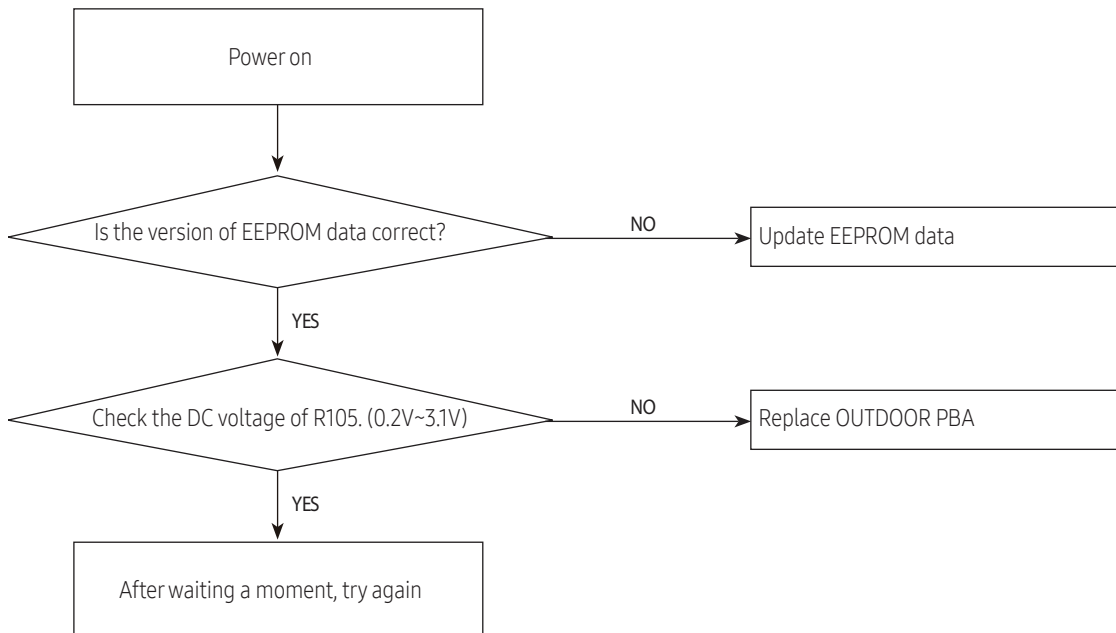

9-2-41 GAS SHORTAGE ERROR / GAS LEAK ERROR

Indoor display

7-SEG DISPLAY	DESCRIPTION
C554	GAS SHORTAGE ERROR
C574	GAS LEAK ERROR

Outdoor display



● LED ON ● LED BLINKING ○ LED OFF

1. Checklist :

- 1) Check the installation environment.
: At the site where several units were installed at the same time, check whether communication wire and pipes have been wrongly connected
- 2) Service valve tightening status defect
- 3) Pipe failure
- 4) EVAP leakage
- 5) COND leakage
- 6) Shortage of refrigerant

2. Troubleshooting procedure

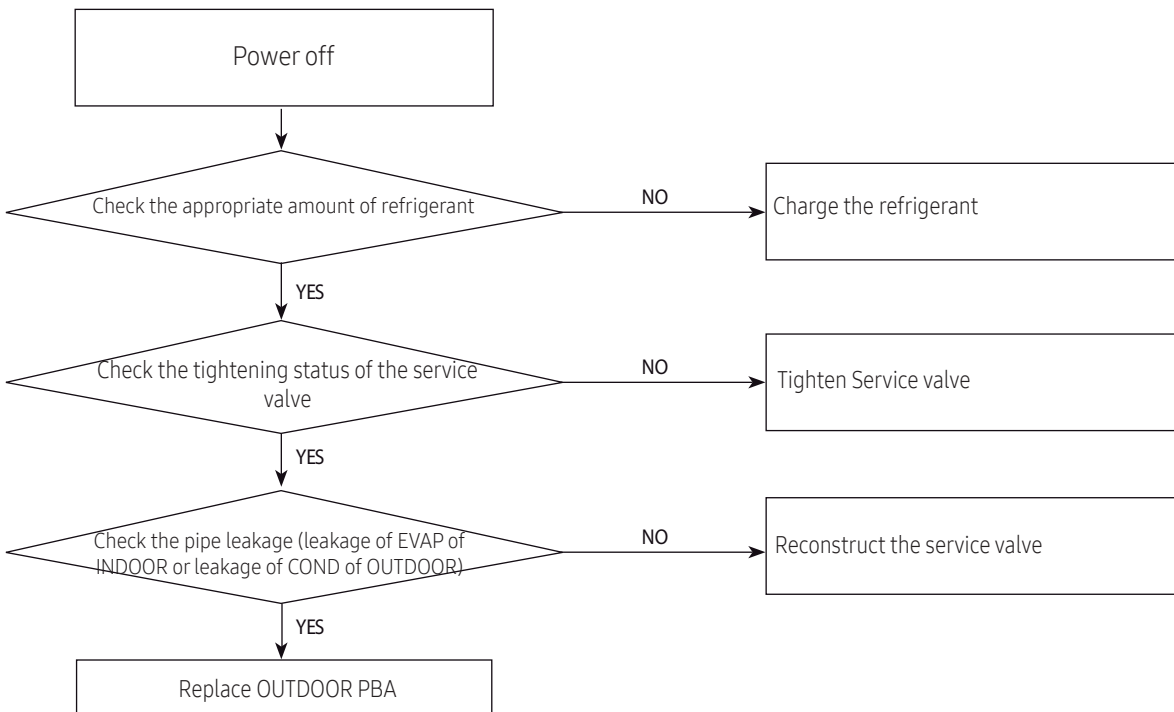

9-2-42 FAN WIRE MISSING ERROR/ROTATION ERROR

Indoor display

7-SEG DISPLAY	DESCRIPTION
C447	FAN WIRE MISSING ERROR /ROTATION ERROR

Outdoor display

●	○	○	FAN WIRE MISSING ERROR /ROTATION ERROR
---	---	---	--

● LED ON ◐ LED BLINKING ○ LED OFF

1. Checklist :

- 1) Is the cable still connected to the fan?
- 2) Is the fan wire connected clockwise? U(RED)-V(WHT)-W(BLK)
- 3) Is the interphase resistance of fan normal?

2. Troubleshooting procedure

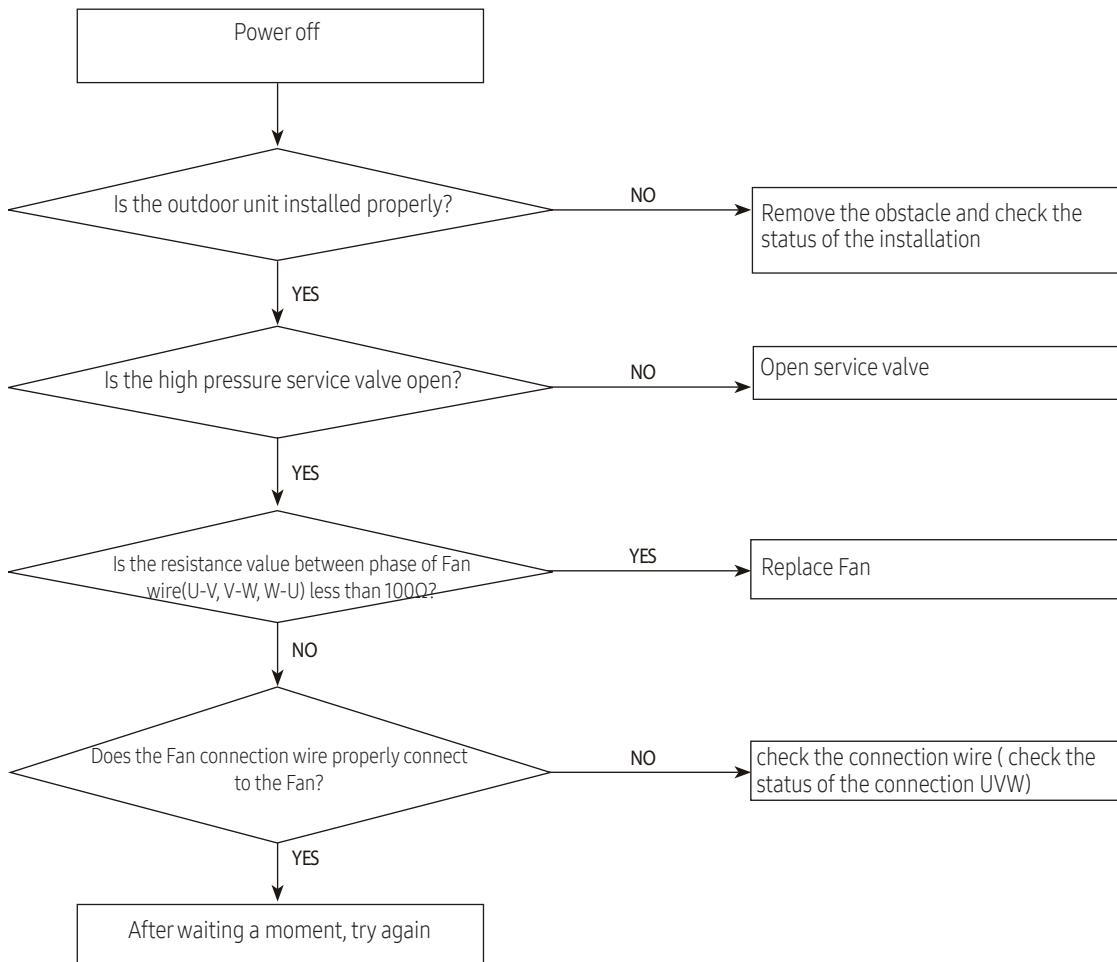

9-2-43 Diagnosis of Inverter PBA using HASS tool

※ HASS (Home Appliance Smart Service)

1. You can diagnose the status of the Inverter PBA

1) In case of outdoor error (464, C478, C465, C489, C461, C446, C462), you can check whether the cause of error is the Inverter PBA, Compressor or fan motor.

2) Select Diagnosis menu, and select Inverter PBA

- If you select comp1, HASS will check problems with Inverter PBA for driving compressor.
- If you select fan1, HASS will check problems with Inverter PBA for driving fan motor.

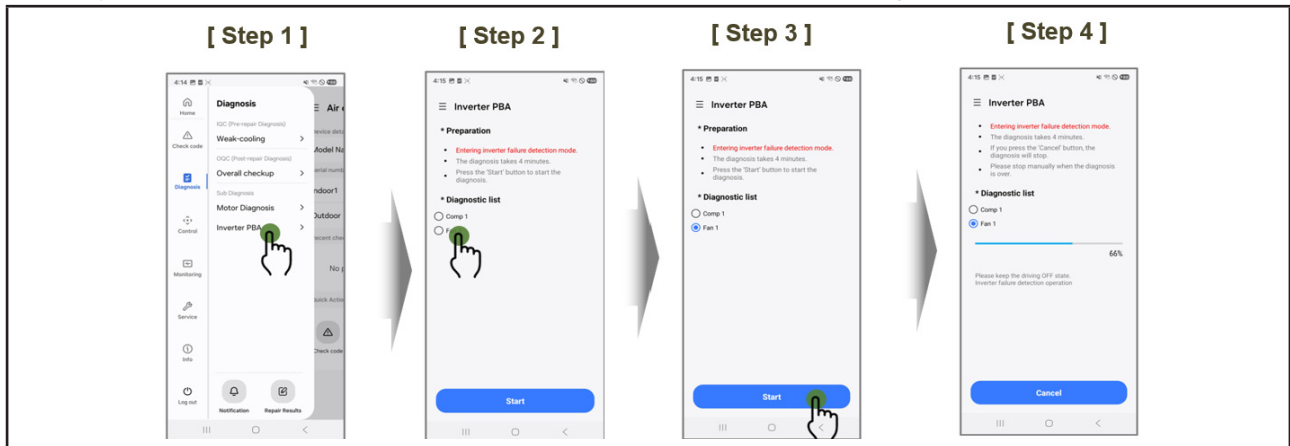

3) After diagnosis using HASS

- If the Inverter PBA for driving fan motor is normal, it is necessary to check motor and motor wire connection
- If the Inverter PBA for driving comp is normal, it is necessary to check comp and comp wire connection
- If the Inverter PBA has failed replace the Inverter PBA

Result	Cause
PASS	<ul style="list-style-type: none"> ▪ Inverter PBA Normal ▪ Compressor and wire connection, etc. need to be checked ▪ Fan motor and wire connection, etc. need to be checked
Need to Check	<ul style="list-style-type: none"> ▪ Inverter PBA failure ▪ Inverter PBA replacement required
Need to Check	<ul style="list-style-type: none"> ▪ Communication error ▪ Check E2P and check communication between indoor and outdoor
Need to Check	<ul style="list-style-type: none"> ▪ Need to Manual check ▪ It is difficult to determine inverter PBA or comp. or motor defect
Not supported model	<ul style="list-style-type: none"> ▪ It can be diagnosed from the model <u>produced</u> in '21

10. Block Diagram

10-1 Indoor unit

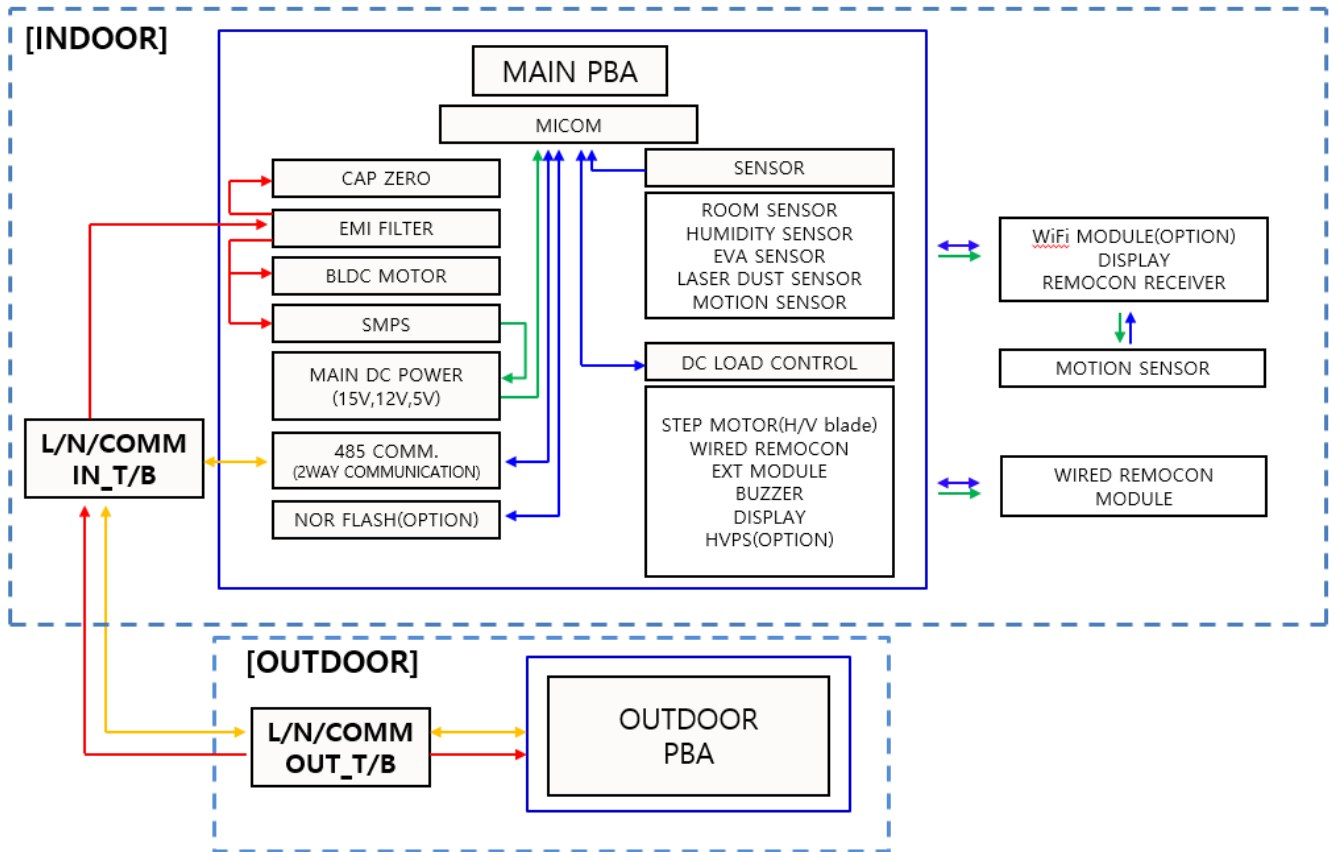

10-2 Outdoor unit

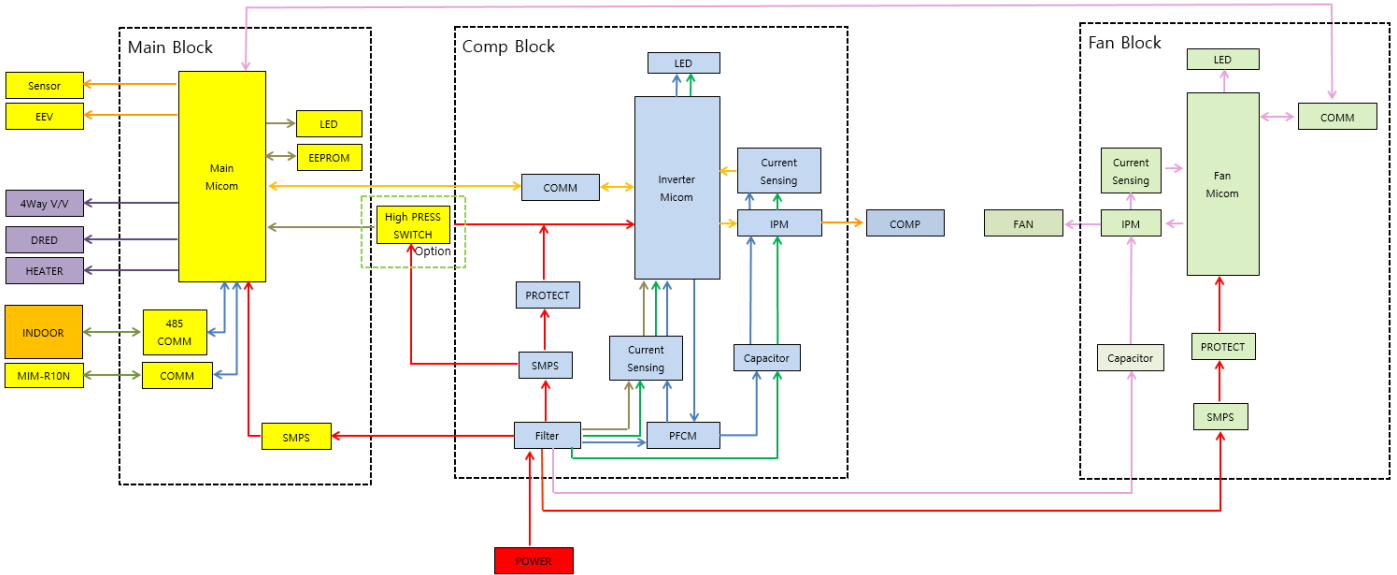

10-2-1 Pre-inspection Notices

- 1 Check if you pulled out the AC power plug when you remove the PCB or front panel.
- 2 Don't hold the PCB side and not use excessive force to remove the PCB.
- 3 Don't pull the lead wire but hold the whole housing to connect or disconnect a connector to the PCB.
- 4 In case of outdoor PCB disassembly, check first the complete discharge of the capacitors after 1 minute power off. Otherwise, the stored energy in the capacitors can cause an electric shock.

10-2-2 Inspection procedure

- 1 Check connector connection and peeling of PCB or bronze coating pattern when you think the PCB is broken.
- 2 The PCB is composed of 3 parts.
 - Indoor Main part : MICOM and surrounding circuit, relay, fan motor sensing and driving circuit, temperature sensing circuit power circuit of SMPS, buzzer circuit. Communication circuit.
 - Display part : LED lamp, Switch, Remote-control module.
 - Outdoor Main part : MICOM and surround circuit, fan motor sensing and driving circuit, compressor driving circuit power circuit of SMPS, PFC control circuit, 4way circuit, communication circuit, OPTION (EEV control circuit, temperature sensing circuit).

10-2-3 Indoor detailed inspection procedure

No.	Procedure	Inspection Method	Cause
1	Plug out and pull the PCB out of the control box Check the PCB fuse	1) Is 1st fuse disconnected?	<ul style="list-style-type: none"> • Over current • Indoor Fan motor short • AC part and pattern short of Indoor PBA
2	Supply power If the operating lamp twinkles at this time , the above 1)~3) have no relation	Check the power voltage	
		1) Is the BD100 input voltage 200Vac~240Vac?	<ul style="list-style-type: none"> • Power cord is faulty, Fuse open, Wrong Power cable Wiring, AC part is faulty
		2) Is the voltage CE100 or CE102 12Vdc?	<ul style="list-style-type: none"> • Switching Trans of Power circuit is faulty
		3) Is the voltage CE108 5Vdc?	<ul style="list-style-type: none"> • Power circuit is faulty, Load short
3	Press the ON/OFF button 1. Fan speed(high) 2. Continuous Operation	1) Is the voltage over AC 180V being imposed on terminal #3-#5 of fan motor connector (CN900)?	<ul style="list-style-type: none"> • Fan motor of the indoor is faulty
		2) The fan motor of the indoor unit doesn't run	<ul style="list-style-type: none"> • Fan motor connector(CN900) is faulty
		3) The power voltage between terminal #3-#5 of the connector(CN900) is 0V	<ul style="list-style-type: none"> • PBA is faulty

10-2-4 Outdoor detailed inspection procedure

No.	Procedure	Inspection Method	Cause
1	Plug out and pull the PCB out of the control box. Check the PCB fuse (Wait 3 minutes after power off)	1) Is 1st fuse disconnected?	<ul style="list-style-type: none"> Over current AC part and pattern short of Outdoor PBA
2	Check the Wiring	1) Is the Compressor wire connected clockwise? 2) Is the Reactor wire connected normally? 3) Is the Fan wire connected normally? 4) Is the 4way wire connected normally? 5) Is the sensor wire connected normally? 6) Is the EEV wire connected normally?	<ul style="list-style-type: none"> Wrong assembly Installation(service) condition is bad
3	"Supply power and operate the set (Use Remote-control, button in indoor set)"	Check the power voltage	
		1) Is the voltage between Terminal block L-N 200Vac~240Vac?	<ul style="list-style-type: none"> Power cord is faulty, Wrong Power cable Wiring
		2) Is the C006 voltage 200Vac~240Vac?	<ul style="list-style-type: none"> Fuse open .L,N,F1,F2 wire wrong wiring (Terminal Block-PBA)
		3) Is the BD151 voltage 200Vac~240Vac?	<ul style="list-style-type: none"> Power circuit is faulty Load short
		4) Is the BD051(#2-#3) voltage 200Vac~240Vac after 3 minutes later?	<ul style="list-style-type: none"> Fuse open L,N,F1,F2 wire wrong wiring (Terminal Block-PBA) .PT020 open .RY021, RY022 is faulty Outdoor Micom(MIC200) error
		5) Is the CE101 voltage 280Vdc~320dc after 3 minutes later?	<ul style="list-style-type: none"> BD051 is faulty Power circuit is faulty, Load short
		6) Is the voltage CE161 voltage 15Vdc?	<ul style="list-style-type: none"> Switching Trans of Power circuit is faulty Load short
		7) Is the voltage CE175 voltage 12Vdc?	<ul style="list-style-type: none"> Switching Trans of Power circuit is faulty Load short
		8) Is the voltage CE174 voltage 5Vdc?	<ul style="list-style-type: none"> Switching Trans of Power circuit is faulty Load short
4	Check the LED lamp display	1) Normal : RED on, GRN blink, YEL off 2) Abnormal - All o check no power - abnormal display : check error mode	<ul style="list-style-type: none"> F1,F2 wire wrong wiring Outdoor PBA is faulty

11. Reference Sheet

11-1 Low Refrigerant Pressure Distribution

Note : Please measure the refrigerant pressure after the air conditioner operates on testing cooling mode for more than 10 minutes.

■ **Indoor Temp. Variation :** 20°C ~ 32°C

■ **Outdoor Temp. Variation :** -5°C ~ 45°C

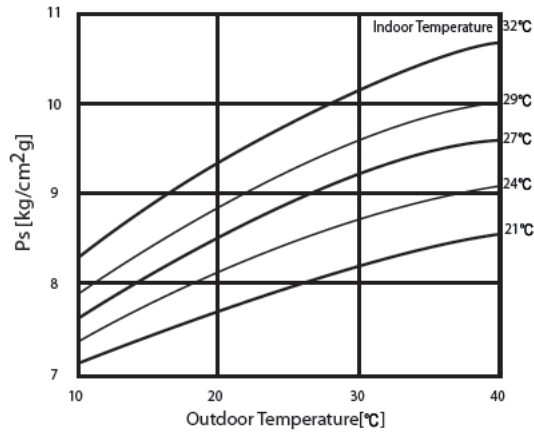

11-2 Pressure & Capacity mark

■ Power/Heat

W	cal/s	kcal/h	Btu/h	HP	kg.m/s	lb.m/s
1	0.23885	0.85985	3.4121	0.001341	0.10197	0.73756
4.1868	1	3.6	14.286	0.0056146	0.42693	3.088
1.163	0.27778	1	3.9683	0.0015596	0.11859	0.85778
0.29307	0.06999	0.252	1	3.9302x10 ⁻⁴	0.029885	0.21616
745.7	178.11	641.19	2,544.4	1	76.04	550
9.8067	2.3423	8.4322	33.462	0.013151	1	7.233
1.3558	0.32383	1.0658	4.6262	0.0018182	0.13826	1

11-3 Q & A for Non-trouble

Classification	Class	Description
Cooling	Q	The cooling is weak.
	A	When it is hot outside, its cooling capacity decreases due to the increase in the ambient temperature. When the dust filter gets blocked or warm outside air gets in, the cooling capacity will decrease. So, make sure to clean the dust filter frequently, prevent heat loss by closing the doors and insulate the cooling area by using curtains, blinds, shades or window tinting.
	Q	The cooling is good generally. But, it gets weak when it is considerably hot.
	A	It occurs when the outdoor unit is exposed to direct sun light and heat-up air is not ventilated well. So, set up a sunblind over the outdoor unit and keep sunlight away from the unit to increase the ventilation. When the cooling capacity decreases during a heat wave, clean the heat exchanger of the outdoor unit or spray some cold water to the heat exchanger to increase the cooling capability.
	Q	The cooling is weak. Does it need refrigerant charging?
	A	It is not correct to charge refrigerant regularly. Except when you have moved several times or the connection pipes are broken, the refrigerant does not run low. So, when refrigerant is additionally charged, it could be costly and cause a product's failure. When the refrigerant leaks, all of it will escape in a short time resulting in cooling failure and no water coming out of the drain hose. So, When water comes out of drain hose it means that the HX is getting cold enough to be below dew point, but it's still possible for the unit to be undercharged, leaking or being installed with too long pipes.
	Q	It fails to do cooling.
	A	When the air conditioner is set to ventilation or the desired temperature is set higher than the current temperature, it fails to do cooling. In this case, select cooling or set the desired temperature lower.
Leakage	Q	Water drips from the indoor unit.
	A	Place the drain hose properly. When it is not placed properly, the drain water would flow back flooding the floor. So, straighten out the drain hose for the water to be drained well.
	Q	Water drips at the drain connection (service valve) of the outdoor unit.
	A	When a glass bottle is taken out of the refrigerator, moisture gets condensed on its surface due to the temperature difference. The same principle applies to the air conditioner. When cold refrigerant goes through the copper tube, moisture gets condensed on the surface of the tube and the connection areas. To prevent the water condensation, the pipes are insulated. But, the connection areas of the outdoor unit are not insulated for the purpose of maintenance or repair, and water gets condensed due to the temperature difference and drips down. Generally, it evaporates right away. But, when it drips a lot during muggy days, put a water pan on the floor.
	Q	It leaks even though a drain pump is used.
A	It occurs when the drain pump is plugged out or it is out of order. Check the power of the drain pump and the position of the drain hose, and when the pump is faulty, contact the drain pump manufacturer. Samsung Electronics does not manufacture drain pumps. So, we are not able to correct the drain pump problems.	
Smells	Q	Whenever the air conditioner is turned on, it irritates my eyes and gives me a headache.
	A	There are no components in the air conditioner irritating the eyes and sending out chemical smells. But, when the air conditioner is turned on, other smell sources are sucked into the air conditioner and get out of it. So find and root out the smell sources. Generally, it occurs at a interior renovated place, a pharmacy, a gasoline handling place, a tire shop, a second-hand book shop or an electronic component handling place, when its chemical or musty smells are sucked in and sent out, it can be misled that the air conditioner generates them.

Classification	Class	Description
Smells	Q	Whenever the air conditioner is turned on, it stinks.
	A	When there is no in the air conditioner sending out chemical smells. But, when the air conditioner is turned on, other smell sources are sucked into the air conditioner and get out of it. So, find and root out the smell sources. Generally, when the drain hose is taken out to the washing room or there are sources of smells such as a diaper bin, a shoe shelf or a socks bin, bad smells generate. Also, it occurs where glass cleaners or air fresheners are used; when they are sucked in interacting with dusts and moistures inside, bad smells generate. these kinds of organic materials are noxious to human bodies. So, we recommend against the use of them.
	Q	Whenever the air conditioner is turned on, it smells sour.
	A	When the room is papered recently, the wallpaper glue scent would be sucked inside. Also, when the air conditioner is installed in the study room of young boys or girls who love sweat generating activities such as basketball, excessive sweats evaporate and get sucked into the air conditioner resulting in bad smells. So, find and root out the problem or refresh the room frequently.
	Q	Whenever the air conditioner is turned on, it smells musty.
	A	It is due to the improper keeping of the product after its use. When keeping the product, dry up the inside with the operation of ventilation to prevent must. When the product is kept without drying up the inside with ventilation, mold would grow inside resulting in must. So, open the windows and switch on the ventilation function to get rid of the saturated smell inside.
	Q	Whenever the air conditioner is turned on, it sends out bad smells such as stale smells.
	A	It occurs generally when there are pet animals in the house. Their smells stay at the same place. But, when the air conditioner is turned on, the air gets circulated resulting in the circulation of the smells. So, find and root out the problem or refresh the room frequently.
	Q	It sends out bad smells.
A	When the air filter is filthy, it could send out bad smells. So, clean the filter and ventilate the room with the windows open while operating the ventilation function.	
Operation	Q	It won't start.
	A	There is a power failure or it is plugged out. Also, check if the power distribution panel is switched off.
	Q	It goes off during operation.
	A	When the hot air does not escape properly, it goes off during operation. it occurs when it does not ventilate properly because the outdoor unit is covered, the back of the outdoor unit is blocked by a cardboard or a plywood panel, and the front of the outdoor unit is blocked by the closed window or other obstacles. Clear the above obstacles from the outdoor unit.
	Q	It generally works properly. But, when it's considerably hot, it goes off during operation.
	A	It occurs when the outdoor unit is exposed to direct sunlight and the hot air does not escape properly. Set up a sun blind over the outdoor unit and clear the neighboring obstacles from the outdoor unit to provide good ventilation. When it goes off frequently during a heat wave, it would prevent the turn on and increase the cooling capacity cleaning the outdoor unit or spraying some water to the heat exchanger.
	Q	The remote controller won't operate.
	A	When the batteries run out or the transmitter or receiver of the remote controller is blocked by obstacles, change the batteries or keep the obstacles away from the controlling area. Also, the remote controller may not work under intensive light from a 3-wave length lamp or a neon sign due to the EMI. In this case, take the remote controller closer to the receiver.

Classification	Class	Description
	Q	Who installs the air conditioner? (Relocation/Re-installation)
	A	When relocating or re-installing the air conditioner, make sure to contact Samsung Electronics Service Center or Authorized Service Agent and have them to do the job. (If not, it could cause personal injury or product damage.) The cost for the relocation/re-installation of the air conditioner is subject to the customer's expense. There is a cost table. But, our service engineer needs to visit to total up the cost correctly. When you move in, make sure to contact Samsung Electronics Service Center or Authorized Service Agent in advance to streamline the process.
	Q	Is it possible to install the outdoor unit outside?
	A	It is permissible to install this system at a specified area within the residential premises or on the adjacent rooftop. Nevertheless, depending on local regulations, affixing an angled steel enclosure housing the external apparatus externally onto the residence might be unlawful. Moreover, positioning said external mechanism outdoors so as to impede pedestrian traffic would likewise contravene legal standards.
	Q	What can be done to install the outdoor unit facing the road because it is a commercial building?
	A	The following is an excerpt from building code going into effect from JUNE 1 st 2005. "The exhaust pipe of a cooling or ventilation facility installed in a building adjacent to the streets of commercial or residential areas shall be installed higher than 2 m to prevent the exhaust air from blowing directly to passersby and the current facilities shall be corrected by MAY 31 st 2005." So, please install it higher than 2 m or not to blow the hot exhausting air directly to passers-by.
	Q	What about installing a windscreen during installation not to blow hot air directly to passers-by?
	A	When the hot air from the front of the outdoor unit is blocked, the product's performance will be affected and it will fail to operate properly. So, keep it at least 300mm away from its surrounding walls and give it good ventilation.

11-4 Cleaning /Filter Change

Auto clean function

Use the Auto clean function if the indoor unit produces odors.

Activating Auto clean

To activate Auto clean, press the  (Options) button for at least 3 seconds.
The indoor unit display shows:

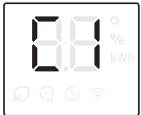

If the air conditioner is off, Auto clean starts immediately. If the air conditioner is running, Auto clean starts as soon as the air conditioner turns off.

NOTE

- You can also activate Auto clean from the Options menu:



- Once Auto clean is selected, it is always activated whenever the air conditioner turns off.
- Auto clean runs for 10 to up to 30 minutes depending on internal dry conditions. The indoor unit display shows the cleaning progress from 1% to 99%.
- If you start another function while Auto clean is progressing, Auto clean pauses and will resume when the other function stops.
- When Auto clean completes, the air conditioner turns off.

Canceling Auto clean

To cancel Auto clean while it is running, follow the procedure below:

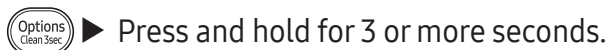

OR



NOTE

- Canceling Auto clean does not deactivate it.

Deactivating Auto clean

To deactivate Auto clean, follow the procedure below while the air conditioner is in operation :

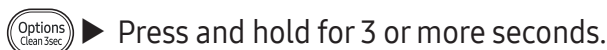

OR



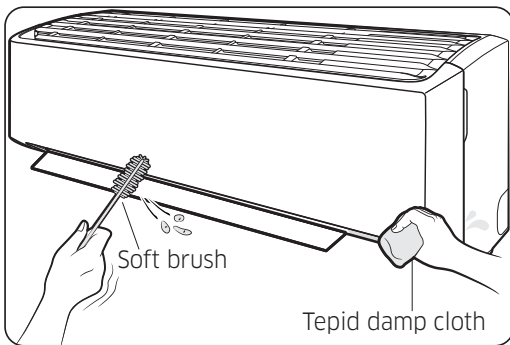

Cleaning the outside of the indoor unit

- 1 Turn off the air conditioner and wait until the fan stops.
- 2 Disconnect the power supply.
- 3 Use a soft brush or Lukewarm damp cloth to clean the exterior.

⚠ WARNING

- Do not clean the appliance by spraying water directly onto it. Water entering the unit may result in electric shock or fire that could cause death, serious injury, or property damage:

⚠ CAUTION

- Do not use an alkaline detergent to clean the indoor unit display.
- Do not use sulphuric acid, hydrochloric acid, or organic solvents such as paint thinner, kerosene, acetone, benzene, or alcohol to clean the unit surfaces.

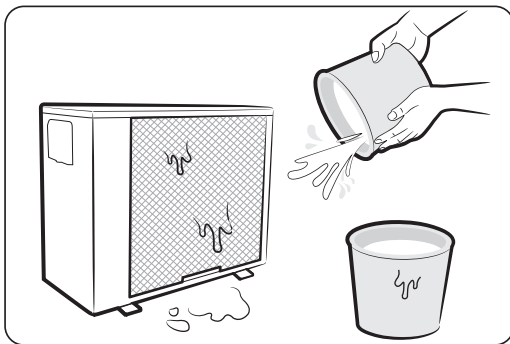

Cleaning the heat exchanger on the outdoor unit

- 1 Turn off the air conditioner and wait until the fan stops.
- 2 Disconnect the power supply.
- 3 Spray water on the heat exchanger to remove dust and other debris.

⚠ CAUTION

- Do not use sulphuric acid, hydrochloric acid, or organic solvents such as paint thinner, kerosene, acetone, benzene, or alcohol to clean the unit surfaces.
- If you need to inspect or clean the inside of the heat exchanger on the outdoor unit, contact a local service centre for help.

Cleaning the filter

Clean the air filter every two weeks or when the **CF** (filter-cleaning reminder) appears on the indoor unit display. The time between cleanings may vary, depending on the usage and environmental conditions.

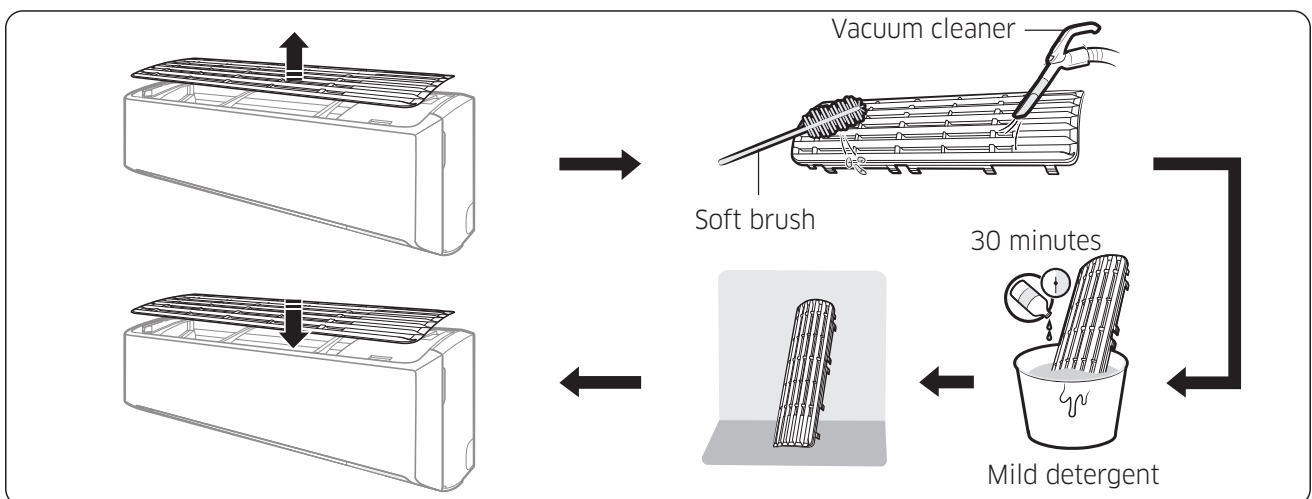

- 1 Slide the filter off of the unit.
- 2 Use a soft brush or vacuum cleaner to remove any dust or debris on the filter.
- 3 Soak the filter in a solution of water and mild detergent for 30 minutes.
- 4 Rinse the filter and let it air dry in a well-ventilated area that is out of direct sunlight.
- 5 Reinstall the filter.
- 6 Reset the filter-cleaning reminder:

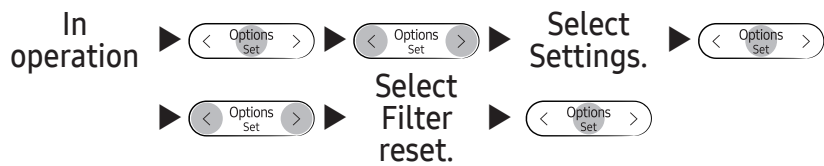

⚠ CAUTION

- Take care not to damage the filter during cleaning.
- Do not scrub the air filter with a hard-bristle brush or another cleaning utensil.
- Do not expose the air filter to direct sunlight when drying it.

11-5 Installation

11-5-1 Before Installation

Keep the air conditioner outlet and inlet free from any obstruction in the surroundings and make sure that both indoor and outdoor units are horizontally level to prevent vibration. The pipe length shall meet the standard as far as possible.

11-5-2 Installation Procedure

■ Location

When choosing the installation location, try to find the place that will provide the best cooling performance and most convenience for piping and electric work. The outdoor unit should be installed on a strong structure that does not vibrate and the outdoor unit should not be exposed to strong winds.

■ Wall Drilling

Use a standard 65 mm hole saw to drill one hole at the selected location, at a 15° downward angle so that the drain hose will drain properly.

■ Fixing Indoor Unit & Outdoor Unit

Fix the air conditioner indoor unit securely to the wall. Secure the outdoor unit in a suitable position.

■ Pipe Spooling & Connecting

You shall cut the pipe with a pipe cutter and grind all the burrs of the cut surface. pipe expansion may continue until the pipe surface becomes uneven or torn apart. Be sure to use a torque wrench to tighten pipes or nuts.

<Torque & Depth>

Outer Diameter (D)	Torque(kgf-cm)	Depth(A)
ø6.35 mm(1/4")	140~170	1.3 mm
ø9.52 mm(3/8")	250~280	1.8 mm
ø12.70 mm(1/2")	380~420	2.0 mm
ø15.88 mm(5/8")	440~480	2.2 mm
ø19.05 mm(4/4")	9900~1,210	2.2 mm

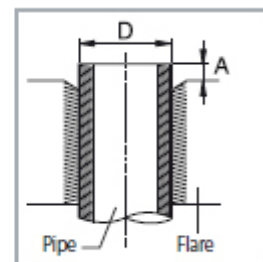

■ Leak Test

Put an inert gas like nitrogen in the outdoor unit pipe and put soap bubbles or other test liquids on the pipe surface for the leak test.

■ Drain Hose Connecting

Install the drain hose downward to drain water naturally. Be sure to pour water into the hose to check if it drains well.

■ Electric & Earth Work

Electric and earth work shall meet the "Electric Facility Technology Standard" and the "Internal Wire Regulation" of the Electric Business Laws.

■ Inspection & Trial Run

Upon completion of the tests, you shall make a trial run while you explain the main functions of the air conditioner to finish the installation.

11-6 Installation Diagram of Indoor Unit and Outdoor Unit

11-6-1 Air-Purge Procedure

1) Connect each assembly pipe to the appropriate valve on the outdoor unit and tighten the flare nut.



2) Connect the charging hose of low pressure side of manifold gauge to the packed valve having a service port (3/8" Packed valve) as shown at the figure.



3) Open the valve of the low pressure side of manifold gauge counter-clockwise.



4) Purge the air from the system using vacuum pump for about 30 minutes.
- After that, please recheck that pressure is stabilized.
- Close the valve of the low pressure side of manifold gauge clockwise.
- Remove the hose of the low pressure side of manifold gauge.



5) Set valve cork of both liquid side and gas side of packed valve to the open position.



6) Mount the valve stem nuts to the 2 way and 3 way valve. And mount the service port cap to 3 way valve.



7) Check for gas leakage.
- At this time, especially check for gas leakage from the 3 way valve's stem nuts, and from the service port cap.

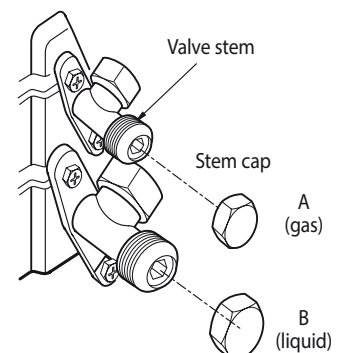
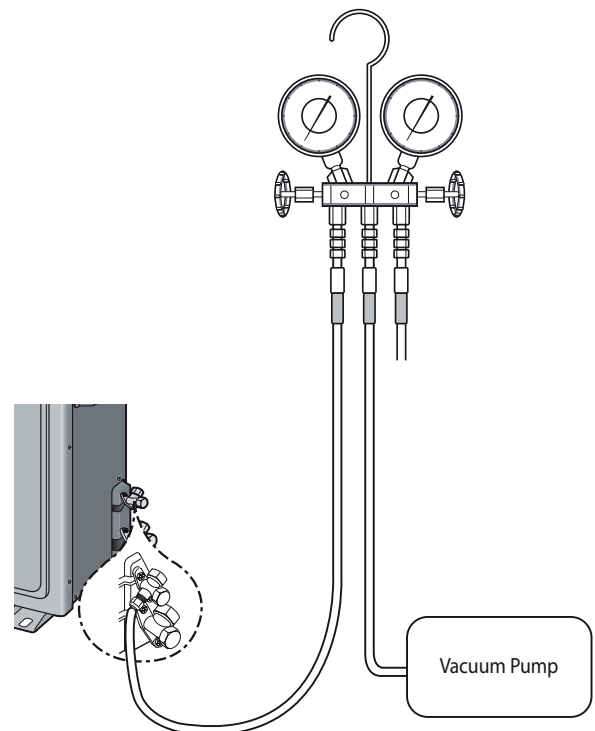
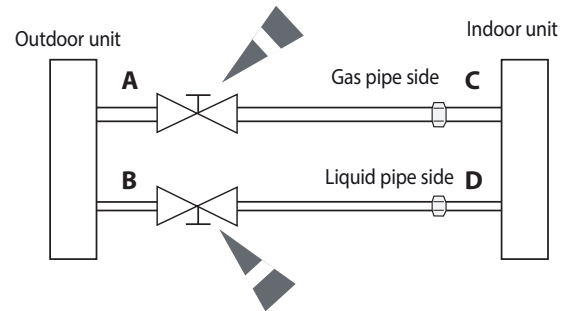

11-6-2 "Pump down" Procedure

Pump down will be carried out when an evaporator is replaced or when the unit is relocated in another area.

1) Remove the caps from the 3 way valve and the 3 way valve.



2) Turn the 3 way valve clockwise to close and connect a pressure gauge (low pressure side) to the service valve, and open the 3 way valve again.



3) Set the unit to cool operation mode.
(Check if the compressor is operating.)



4) Turn the 3 way valve clockwise to close.



5) When the pressure gauge indicates "0" turn the 3 way valve clockwise to close.



6) Stop operation of the air conditioner.



7) Close the cap of each valve.

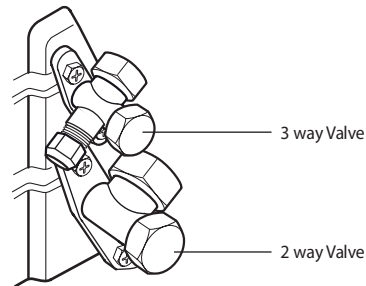

Remarks

Relocation of the air conditioner

- Refer to this procedure when the unit is relocated.
- Carry out the pump down procedure (refer to the details of 'pump down').
- Remove the power cord.
- Disconnect the assembly cable from the indoor and outdoor units.
- Remove the flare nut connecting the indoor unit and the pipe.
- At this time, cover the pipe of the indoor unit and the other pipe using a cap or vinyl plug to avoid foreign material entering.
- Disconnect the pipe connected to the outdoor unit.
At this time, cover the valve of the outdoor unit and the other pipe using a cap or vinyl plug to avoid foreign material entering.
- Make sure you do not bend the connection pipes in the middle and store together with the cables.
- Move the indoor and outdoor units to a new location.
- Remove the mounting plate for the indoor unit and move it to a new location.

11-7. Reference Sheet

Index for Model Name

1st	2nd	3rd	4th	5th	6th	7th	8th	9th	10th	11th	12th	13th	14th
Product		Series		Year	Capa (K BTU)		Cooling Type	AI Level	Derivation	CMF	SET Type	Country	
A	R	5	0	F	1	2	C	1	A	H	N/X	E	U

Digit NO	1	2	3	4			5	6	7	8				
	Product		Series				Year	Capa (K BTU)		Cooling Type				
Code	<u>A</u>	<u>R</u>	<u>7</u>	<u>0</u>			<u>F</u>	<u>0</u>	<u>9</u>	<u>D</u>				
		Type		ALL-IN-1 LEVEL	FILTER	WIND FREE				INV.	HP	REF		
AR	Airconditioner	Room	90	Infinite	Integrated control of Temperature and humidity	PM1.0	O	T: 2020	5	5K BTU/H	A	O	O	R290
AF		Floor	80	Premium		PM1.0	O	A: 2021	7	7K BTU/H	B	O	-	R290
AW		Window	70	Deluxe		PM2.5	O	B: 2022	9	9K BTU/H	C	O	O	R32
			60	Standard		-	O	C: 2023	12	12K BTU/H	D	O	-	R32
			50	Entry		-	-	D: 2024	15	15K BTU/H	E	O	O	R410a
			40	Entry (O/S)		-	-	F: 2025	18	18K BTU/H	F	O	-	R410a
									24	24K BTU/H	G	-	O	R32
									30	30K BTU/H	H	-	-	R32
											J	-	O	R410a
											K	-	-	R410a

9						10						11			12		13		14	
AI Level						Derivation						CMF			SET Type		Country			
<u>1</u>						<u>A</u>						<u>W</u>			<u>N</u>		<u>E</u>		<u>U</u>	
	VISION	VIDEO	SET BIXBY	SENSOR	WIFI							Color	Design							
4	O	O	O	RADAR	O	A	1st MODEL					W	White	GEO	/	CBU SET				
3	-	O	O	RADAR	O	B	2nd MODEL					B	Black	AIRISE	N	CBU IDU				
2	-	-	O	MDS/CSI	O	C	3rd MODEL					H	White	AIRISE	X	CBU ODU				
A	-	-	-	MDS	O	D	4th MODEL					M	Mint	BESPOKE	1	CKD SET				
1	-	-	-	-	O	E	5th MODEL					G	Grey	BESPOKE	U	CKD IDU				
0	-	-	-	-	-	F	6th MODEL								W	CKD ODU				
						1	Grade 1, 1★								2	SKD SET				
						2	Grade 2, 2★								Y	SKD IDU				
						3	Grade 3, 3★_India MR/RR													
						4	Grade 4, 4★_India MR/RR													
						5	Grade 5, 5★_India MR/RR													
						S	Energy Star (High efficiency)													
						L	India_Online 3★													
						M	India_Online 4★													
						N	India_Online 5★													
						P	India_Reliance 3★													
						Q	India_Reliance 4★													
						R	India_Reliance 5★													
						X	India_Disty 3★													
						Y	India_Disty 4★													
						Z	India_Disty 5★													
						V	Power Volt													

SAMSUNG

ELECTRONICS

GSPN (GLOBAL SERVICE PARTNER NETWORK)

Area	Web Site
North America	http://gspn3.samsungcsportal.com
Latin America	http://gspn3.samsungcsportal.com
CIS	http://gspn1.samsungcsportal.com
Europe	http://gspn1.samsungcsportal.com
China	http://china.samsungportal.com
Asia	http://gspn2.samsungcsportal.com
Middleeast & Africa	http://gspn1.samsungcsportal.com

This Service Manual is a property of Samsung Electronics Co., Ltd.
Any unauthorized use of Manual can be punished under
applicable International and/or domestic law.

© Samsung Electronics Co., Ltd.
March 2025