



MIDSUMMER

Delivering tomorrow's energy

RENEWABLE HEAT



Introducing our **bundle offer** on Samsung Heat Pumps with Sunamp Heat Batteries

Save precious space in urban settings

Sunamps are far smaller (25% of the volume) than traditional hot water cylinders and can be positioned more flexibly.

Samsung heat pumps are compact, lightweight and manoeuvrable. They are readily wall-mountable giving far more flexibility if space or positioning is an issue.

Samsung and Sunamp have collaborated to ensure their products work together harmoniously. The Sunamp HW+iLTHP is specifically configured for use as the hot water storage with Samsung heat pumps.



Sunamps vs unvented cylinders:

- Not a pressure vessel so no safety relief drains.
- No annual maintenance or testing.
- Instantaneously heated for freshness and minimal losses.

SAMSUNG

Sunamp

a perfect pairing...



Traditional hot water cylinder

Sunamp heat battery

win back space in the home!

HOW IT WORKS - PIPEWORK

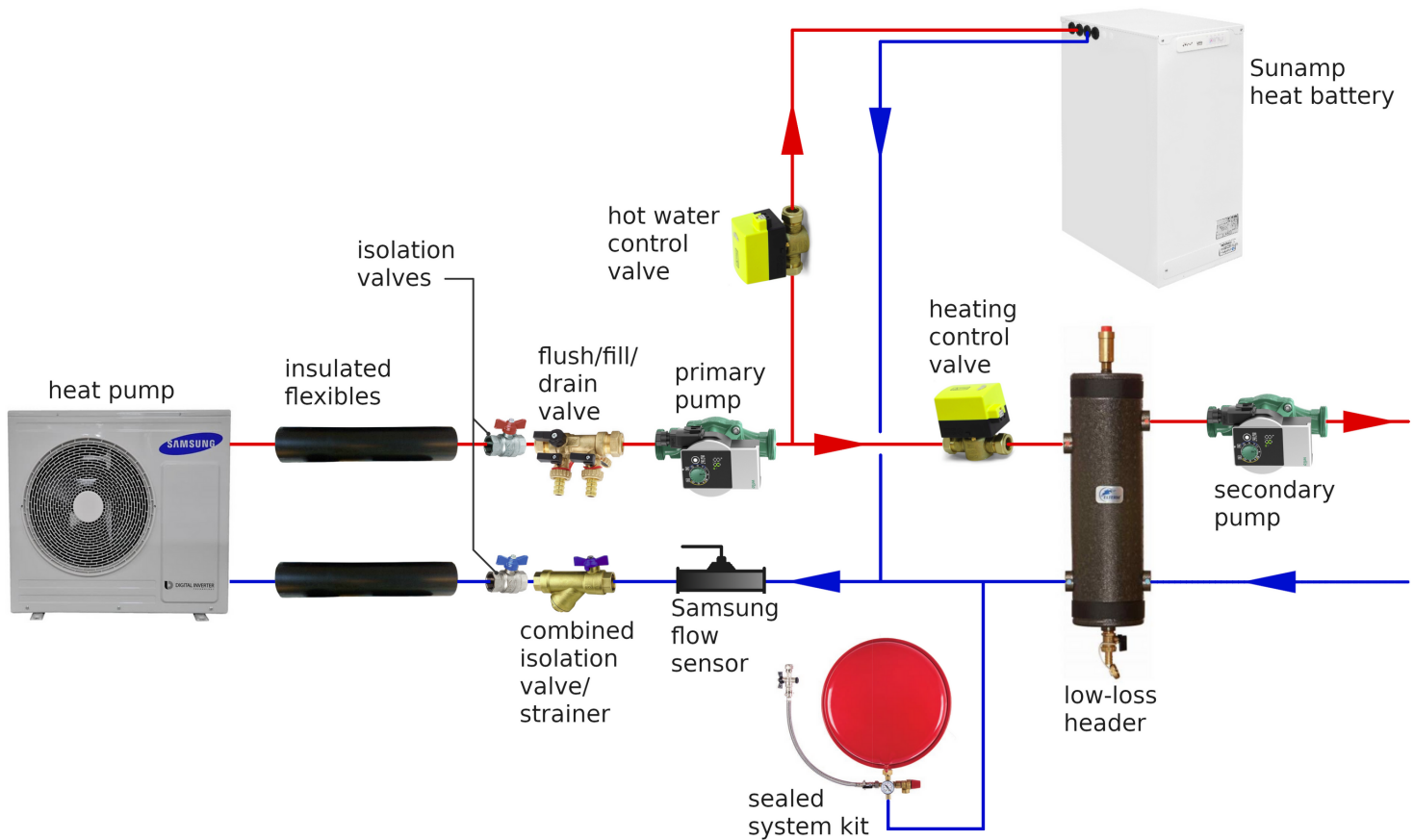

The pipework installation is very like installing a Samsung ASHP with an unvented cylinder as you normally would. The schematic above shows a primary/secondary pumping arrangement with a header but it is also fine to use an automatic bypass valve on the heating pipework if you'd prefer.

The difference with this setup is that instead of running a flow and return to the indirect coil of a cylinder they are piped up to the primary side of the Sunamp (middle 2 pipes under the Sunamp lid).

Because the pressure drop across the Sunamp primary side can be large you need to be careful with your pressure drop calculations and primary pump selection - we can give you a hand with this if you want.

HOW IT WORKS - WIRING

The temperature trick

Wiring a Samsung heat pump to a Sunamp is the same as when using an unvented cylinder except that there's no pocket to insert the temperature probe into. To enable the heat pump to heat up the Sunamp when required and stop when it's fully charged the Sunamp has to 'cheat' the temperature signal by feeding the Samsung controller resistances to fool it into thinking its seeing a cool or hot cylinder.

A little help

When it's very cold outside the Samsung heat pump struggles to produce water hot enough to melt the phase change material in the Sunamp – the Sunamp controller then gives the signal to the Samsung controller to turn on the 'booster heater' (immersion heater) and when the Samsung controller powers up the booster heater terminals this triggers a relay to start the electric heating within the Sunamp, alongside the heat pump running, to help out and make sure the polymer melts.

- Temperature sensor (blue wire): Connect CNSO42 (yellow) on the Samsung controller, snip the cable and strip the cores then terminate them into positions 3 and 4 on the Sunamp board.)
- Immersion/booster heater: Connect TB-A1 (black) on the Samsung controller to the switch side of a relay to control positions 1 and 2 on the Sunamp.

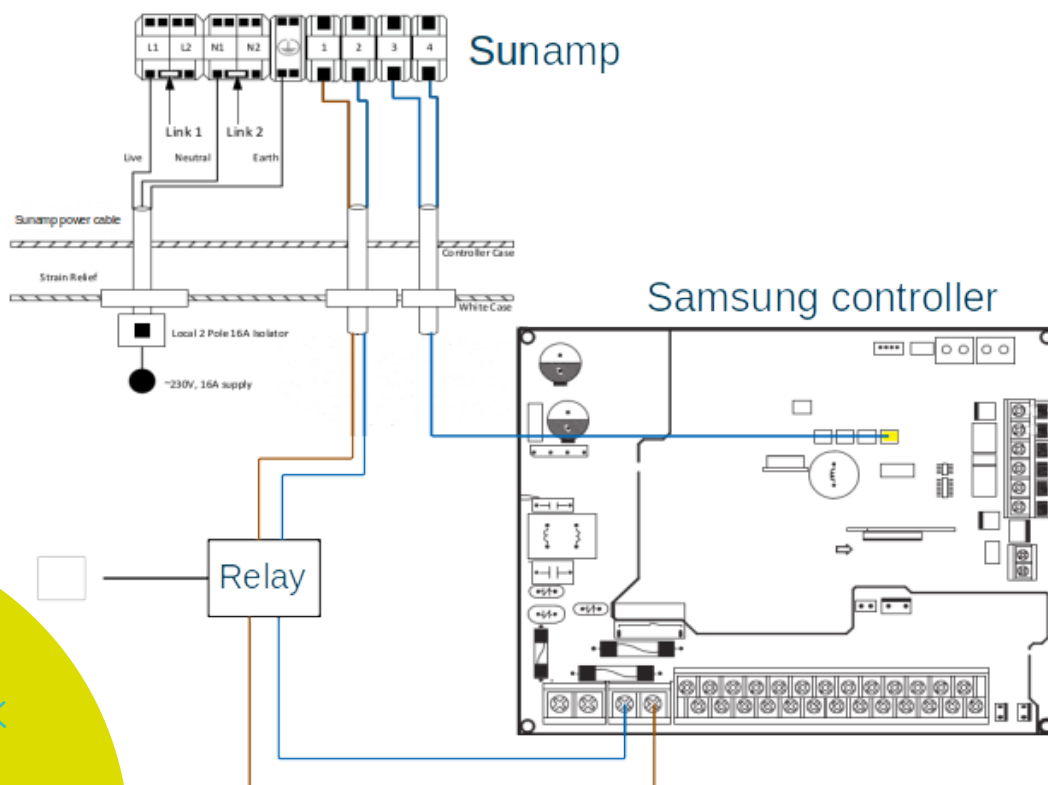

HOW IT WORKS - SETTINGS

Configure the heating settings (weather compensation, thermostat choice etc.) as you normally would for a heating only install or one with an indirect cylinder and then make these specific adjustments to the hot water settings:

There are only a few DHW settings you need to change on the Samsung controller from default when configuring with a Sunamp.



- Change field setting value (FSV) #3011 to (1) cylinder connected.
- Change FSV #1051 - DHW tank temperature - from 55°C to 65°C.
- Change FSV #3021 - heat pump max temperature to 65°C This makes the heat pump run hot enough in hot water mode to melt the PCM in the Sunamp.
- Change FSV #3041 from 1 (on) to 0 (off). This turns off disinfection, which is not required as sanitary DHW is not being stored.
- Set the maximum hot water running time long to give your heat pump a good chance of fully charging the Sunamp in one go. Set FSV #3025 to 90 minutes.
- In the user-accessible menu set the hot water tank temperature to 70°C.

You also need to consider the hot water schedule and the reheat time of the Sunamp. If the hot water usage is likely to be predominantly in the morning and the Sunamp is relatively generously sized a single HWS cycle from 3 to 6am might be sufficient.















If your customer is likely to need a significant amount of hot water in evening or has a minimally sized Sunamp it's probably prudent to have another hot water cycle in the afternoon (maybe around midday if your customer also has PV on the house).

On the Sunamp no settings need to be adjusted as it is configured to be run with a Samsung Monobloc heat pump by default.

BUNDLE CONTENTS

SEE THE KIT DISCOUNTS AT
MIDSUMMERWHOLESAL.CO.UK

See Prices

SYSTEM COMPONENT	INCLUDED IN BUNDLE	NOT INCLUDED
Samsung Heat Pump 5kW or 8kW Mono*		
Samsung control pack MIM-E03CN		
Heat pump feet or wall mount brackets		
Flexible insulated hoses (for heat pump)		
Glycol for heating circuit (Thermox DTX)		
HWS Thermostatic mixing valve		
Sunamp heat battery HW + iLTHP		
Domestic hot water expansion vessel		
Low loss header - Elterm insulated		
Stainer/isolation combination valve		
Flush-fill-drain valve, isolation valves		
Control valves - EPH Pluggable		
Sealed system kit - Altecnic Robokit compact		
Pumps, pipework and lagging		
Thermostat		

*Note: Sunamps cannot be configured to 12kW or 16kW heat pumps, due to required flow rate associated with the heat pump.



MIDSUMMER

RENEWABLE HEAT PRODUCTS

[Explore](#)

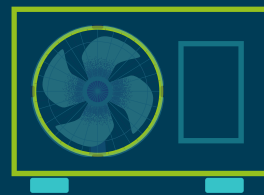

A range of great products for renewable heat, with friendly technical advice on tap, next day delivery, fantastic prices, and easy online ordering



midsummerwholesale.co.uk



jez.climas@midsummerenergy.co.uk



stephen.osuobeni@midsummerenergy.co.uk