

Panasonic



The Power of Partnership

Panasonic Solar



42

years experience in photovoltaics

A quick history of reliability.

Investing in photovoltaic modules is a long-term commitment. Ideally a solar module has a life span of 25 years and over. That makes the relationship with your PV manufacturer almost as durable as the one with your life partner. In order to keep this relationship successful and enjoyable, your PV manufacturer needs to be a partner you can rely on. With 42 years of expertise and experience, Panasonic Solar is a pioneer and technology leader with a unique track record in reliability. Starting in 1975 with the development and early commercial production of amorphous solar cells for industrial and domestic use, no one has spent more time on solar technology research and development than Panasonic.



Panasonic



1975
Begin research and development of amorphous solar cells

1980
First commercialization of amorphous solar cells



1993
Installation of world's first domestic grid connected photovoltaic system



1994
Start of sales of photovoltaic systems for individual homes

1997
Start of mass production and sales of photovoltaic module HIT®

2000
Launch of the world's first bifacial photovoltaic module

2001
Begin construction of Solar Ark, the world's largest photovoltaic power generation system at that time



2003
Launch of the 200W module featuring the world's highest conversion efficiency

2004
Start of production in Nishikinohama factory



2005
Begin production of HIT® Europe in Hungary

2008
Begin production of photovoltaic HIT® at Shiga Factory

2011
Tokai University's solar car, powered by Panasonic HIT® modules, wins the 2011 World Solar Challenge



2012
Begin production of photovoltaic module HIT® in Malaysia



2014
Achieve the world's highest cell conversion efficiency of 25,6% at R&D level. Cumulative production of 1 billion solar cells



2017
20 years of mass production of photovoltaic module HIT®

Solar Power

for everyone

A vision for life.

Reliability is essential for a good partnership between customer and PV manufacturer. But it's not the only thing that keeps a relationship going. There's no progress in business or in a relationship without a vision. A vision keeps things fresh and exciting. Only visions advance our civilization. Panasonic have the vision to make the world a better place. That's why we're continuously looking for fresh and innovative ways to improve our services, throw our know-how into exhilarating and ground-breaking projects to explore untrodden paths and make life more liveable for everyone.



Fujisawa SST (sustainable smart town) is Panasonic's answer to the world's demand for sustainable living. Planned for 1000 households, Fujisawa opened in 2014 with an ultimate goal of being fully self-sustainable for at least 100 years. With the help of Panasonic products, CO₂ emissions will be reduced by 70% and water consumption cut by 30%. Furthermore, the town has been designed for residents to provide constant feedback, allowing the town to continually evolve and meet its sustainable goals. Ultimately Fujisawa SST has become an example of what modern and smart living can be.

Berlin Adlershof will be another smart city project by Panasonic and the first of its kind in Europe. Planned are 6 twin housing blocks with 67 apartments, where people of all ages will live together with the help of modern technology. Panasonic will equip the area with solar modules, batteries, safety and building infrastructure technology as well as assisted living technologies, including our latest Smart Home innovations with heating, cooling and ventilation components.



A better life, A better world



Solar car: The "Tokai challenger" is Tokai University's record breaking solar car powered by Panasonic lithium-ion batteries and HIT® solar modules. Both technologies are optimal for solar car races because of their resilience to high temperatures and their high power output per unit area. We proudly helped the "Tokai challenger" win the 2009 and 2011 World Solar Challenge in Australia, along with the Sasoi Solar Challenge, South Africa 2012 and the Carrera Solar Atacama, Chile in 2014.



100 Thousand Solar Lantern Project: 1.2 billion people in the world do not have access to electricity. This has various negative influences on quality of life. Without light, people are unable to cook, work, or receive medical treatment at night. And without light, children's education is limited to daytime hours. In order to make the world a better place, Panasonic Solar will give 100,000 solar lanterns to off-grid communities by 2018, the year of our 100th anniversary.

©Panasonic Corporation on the image

“Panasonic gives you the highest energy yield”

I. Meijer, Germany, 6.48 kWp facility owner

100% Panasonic for 100% performance.

At Panasonic Solar we have the highest standards on all levels of production. In order not to corrupt these standards, we produce everything ourselves. Our originality guarantees maximum performance with minimum degradation and is one of the reasons for our success. Unlike many competitors who are purchasing solar cells from outside suppliers, we manufacture from the ‘ingot’, which is literally the fundamental building block of a solar system. It consists of high purity silicon and is created in Oregon, USA. From then on the manufacturing process of a Panasonic photovoltaic module HIT[®] can be divided into 3 steps.

Better performance Less degradation

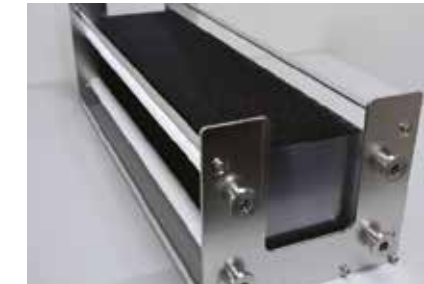

1. Wafers

Diamond wire saws slice the highly pure monocrystalline silicon ingot into silicon wafers thinner than a postcard. Each sliced wafer becomes a substrate for heterojunction cells.



2. Cell

The silicon wafers are cleaned of impurities and texturized. Amorphous silicon layers then form **heterojunctions**. Transparent electrode layers and charge collecting grid electrodes are formed, resulting in **heterojunction** cells with the world’s highest level of power generation. Performance, appearance and other characteristics of each cell are then inspected.

Heterojunction technology

Amorphous layer reduces the electrons lost on the surface resulting in high efficiency.

Heterojunction cell



Conventional crystalline solar cell



3. Module

The cells are connected in series by wiring material to form ‘strings’ and later laminated. After the installation of frames and a junction box, we conduct multiple inspections which exceed international standards. Passing these inspections is essential for our products to be shipped to our customers all over the world.

Quality

verified by internal and external tests

Come rain or shine.

During ideal conditions it's easy to get along. The true quality of a partnership shows when the going gets tough. At Panasonic Solar, we are there for you in good days and in bad days. However, it will rarely be the case that our customers require help with their Panasonic HIT® modules because all of our products are built and tested to withstand even the worst case scenarios. To guarantee the best possible reliability, efficiency and safety of our HIT® modules, we conduct over 20 internal tests above and beyond required international standard tests.

Panasonic internal tests



Wind resistant test

Wind resistant test

Simulates the conditions modules are exposed to during a super typhoon.



Durability test

Durability test

Replicates the harshest conditions seen in the natural environment by combining strong light and high temperatures.

Forced burning test

While standard burning tests only evaluate flammability in case of an external fire, our internal tests also simulate a fire outbreak from inside the module. Even under temperatures as high as 1000°C no fire spreads from the module.

Severe damp heat test

The material is exposed to a high pressure steam test and a temperature and humidity test that is 3 times longer than required by the IEC (International Electrotechnical Commission).

Cold heat shock test

With shorter cycle times and greater temperature differences durability is tested under more severe conditions than the IEC requires.

Reliability Test Result IEC61215 Thermal Cycle Test

Thermal cycle test

The module is subjected to fast changes in temperature from 85°C to -40°C and thus tested on its ability to withstand significant stress on the material.

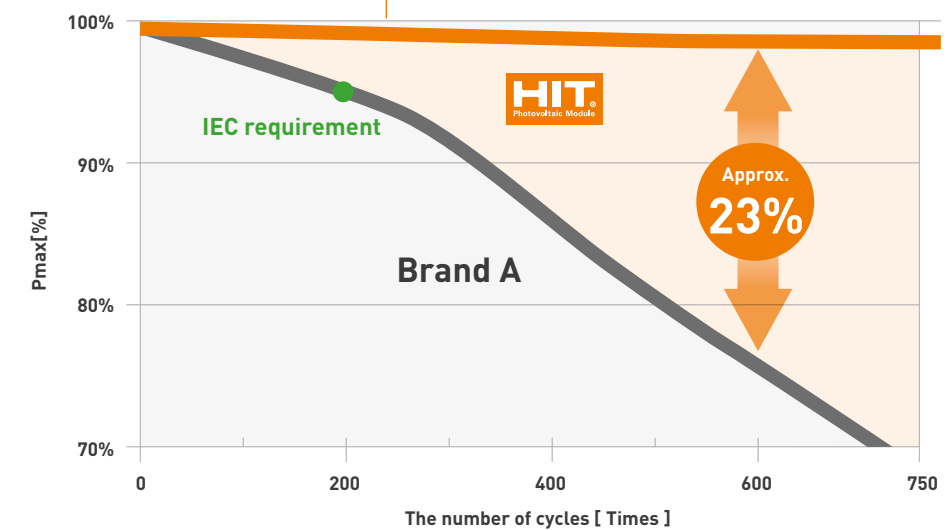

The outstanding Panasonic quality is also approved by third-party certificates

- The TÜV long term sequential test
- The TÜV Fire test, class 1
- PID (Potential Induced Degradation) Free
- Salt-mist corrosion test, severity level 6

25

guarantee

years

Proof not promises.

It's one of the world's undisputed truths that deeds are more persuasive than words. That's why we choose to prove our quality with facts instead of promising you the moon. We have more experience in the photovoltaic business than all of our competitors and are very proud of being able to present you with an unprecedented track record of case studies.

We have countless success stories over many years of fruitful relationships with people who made the decision to install a Panasonic solar system and who continue to be rewarded with reliable performance and stable output over decades of running time.

No downtime in 10 years.

"I am really happy to see that our PV system is so clearly above the expected levels, working flawlessly every day after so many years" – Peter Wagner, owner.

Location: Köngen, Germany
Installation: Winter 2005



+7%*

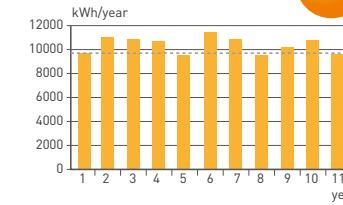

Location: Kifllegg, Germany
Installation: November 2005



+9%*

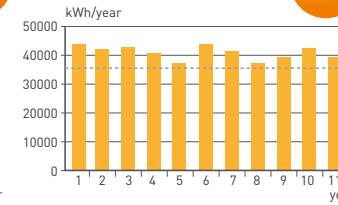

Location: Osaka, Japan
Installation: March 1993



24
fully operational after
years

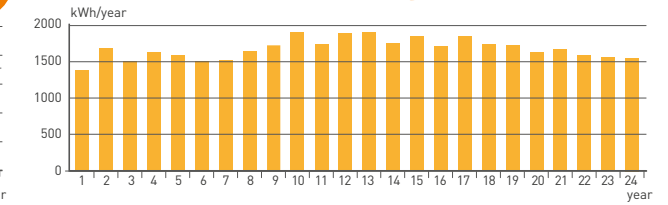

Though the house is not located in the sunniest area in Germany, the solar system is performing well beyond predictions.

0,0035%
failure rate out of 3,94 mio modules

January 2017

Location: Chelsfield, UK
Installation: September 2004



+5%*

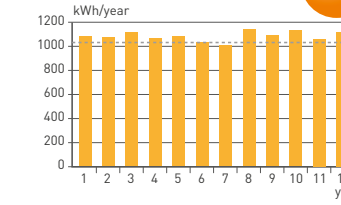

Location: Gunzenhausen, Germany
Installation: 2004



+7%*

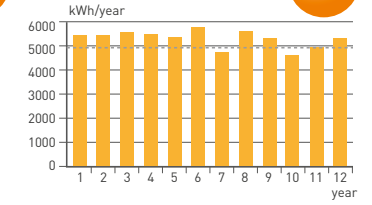

Higher profit over the lifetime of the system

HIT's® slightly higher investment costs are compensated by its outstanding energy efficiency. After 25 years your profit will be significantly higher compared to standard modules.

* compared to calculation by PVGIS [Free online calculation and simulation of solar photovoltaic electrical power]

Sustainable

products and production

A partner to you. A friend to nature.

At Panasonic Solar, a good partnership is not exclusively reserved for clients. It is something we want to share with the whole planet because we believe all of our actions have consequences in this connected world. That's why we have the policy to make all of our production processes as environmentally friendly and sustainable as possible and to make sure we refrain from using ecologically harmful materials.



1. Photovoltaic modules on the roof generate sustainable energy for production facilities and office buildings.

Green factory in Malaysia

One example of our responsible way of working is our green factory in Malaysia. It has been designed to have minimum environmental impact by using a wide range of environmentally friendly technologies.

2. Intelligent architecture

allows the use of natural light in offices and lobbies and thus reduces the use of artificial illumination.



No toxic materials

The RoHS directive restricts the use of hazardous materials in the production process. Though solar modules are not included in this directive, Panasonic ensures all products meet RoHS requirements.

PV Cycle

This voluntary agreement commits us to a return and recycling programme for end-of-life-modules and to take responsibility for solar modules throughout their entire value chain.



3. Recycling of waste heat

from the cooling tower significantly reduces power consumption.



4. Wastewater purification facilities

help save precious water.

5. Waste reduction measures

help sorting and managing a variety of waste that arise during production and reduce the volume of sludge by up to 50%. All measures result in a combined CO₂ reduction of 2,254.5 tonnes per year.



Public Commercial Residential

The universal attraction of competence.

Know-how, experience, innovation, quality, reliability, responsibility and good service are the pillars of successful ventures and held in high esteem all around the world. That's why Panasonic Solar is appealing to so many people and our products and expertise are chosen for a wide variety of projects and fields of application all around the globe. Be it for residential or commercial use or ambitious, large scale public developments, we can deliver the most energy efficient solutions for the most diverse requirements.



Blackfriars Bridge London In January 2014, Network Rail cut the ribbon on the world's largest solar-powered bridge at Blackfriars Bridge across the River Thames. The solar roof is fitted with 4400 Panasonic photovoltaic modules that cover an area of over 6000 m². The modules generate 900,000kWh of electricity every year, saving over 500 tonnes of CO₂ and providing 50% of Blackfriars Station's electricity consumption. In addition to further reducing the carbon footprint of train routes to the South East of England, the distinctive roof has also turned the station into an iconic landmark.

German Federal Environment Agency The annex to the Federal Environment Agency was planned to be a net zero building, generating all the energy it required on a day-to-day basis. Given the limited roof space available, Panasonic HIT[®] were the only modules that could make this a reality. Furthermore the modules are also powering heating and cooling, hot water supply and indoor climate regulation in the building.



National Trust Visitor Centre, Sutton Hoo The historic and the modern merge as the Trust has 174 high-efficiency Panasonic photovoltaic modules installed. The system is part of their commitment to generate 50% of their energy needs through renewable energy installations on their land, while simultaneously reducing energy use for electricity and heating by 20% by 2020.

Pedrollo is one of the world's most important electric water pump manufacturers. Like Panasonic, Pedrollo works with inventiveness and social engagement to make the world a better place by ensuring that water stays a resource freely available for people everywhere. Panasonic Solar is proud for being able to support Pedrollo with solar power to help make life better for everyone.



“The efficiency convinced me”

K. Fischer, Germany, 9.4 kWp facility owner

Our adaptability is your power.

People are different and their individuality shows in their homes. As a result, there is no standard solution when it comes to fitting a roof with the most efficient solar system. Every PV solution has to be the answer to a specific problem and this requires the utmost flexibility from a PV provider. With a range of module sizes, we deliver this flexibility that allows our customers to generate the maximum power possible out of their roof.

The 3 different HIT[®] modules for more power on any roof.



It rarely happens that the dimensions of a roof can be evenly divided by the length and width of a solar module. When covering a roof with standard sized modules you will most likely end up with remaining space too narrow for another row of modules no matter if you install them in a vertical or horizontal format. However with flexible Panasonic HIT[®] modules this problem won't occur.



Portrait



Standard sized modules can't entirely cover the roof in its width.

The slim N245 module perfectly fits in the remaining tight space.

Landscape



Standard sized modules can cover the roof in its width, but not in its height.

The slim N245 module perfectly fits in the remaining tight space.

Complicated



The space between dormer and roof edge is too narrow for another row of **regular sized modules**.

The slim N245 module is the perfect solution.

Portrait



Standard sized modules can cover the roof in its width but not in its height.

The compact N295 helps getting the best out of your roof when there's too much remaining space for a slim module.

Landscape



Standard sized modules can't entirely cover the roof in its width.

The compact N295 helps getting the best out of your roof when there's too much remaining space for a slim module.

Extremely complicated



In this case the combination of **all three Panasonic modules** gets the most power, even out of an extremely complicated roof.



Slim N245

This module is very versatile to install and is particularly suited to narrow, awkward roofs. This allows maximum energy output per unit of surface area.



Compact N295

The low height of this module increases the energy yield of your roof, especially when installed in a vertical position. It also extracts more energy from flat roofs than conventional modules due to the smaller minimum spacing between rows of modules.



Powerful N330

With 19.7% module efficiency, these modules are among the most efficient on the market. Installation costs are lower too, and the BoS (balance of system) costs can be 24% less than with conventional modules.





Photovoltaic modules HIT®

The powerful components of a lifelong relationship.

Photovoltaic module HIT® N330

weight: 18.5 kg
weight/m²: 11.3 kg/m
unit: mm

Snow and Wind Load : 2400 Pa

Dimensions and weight

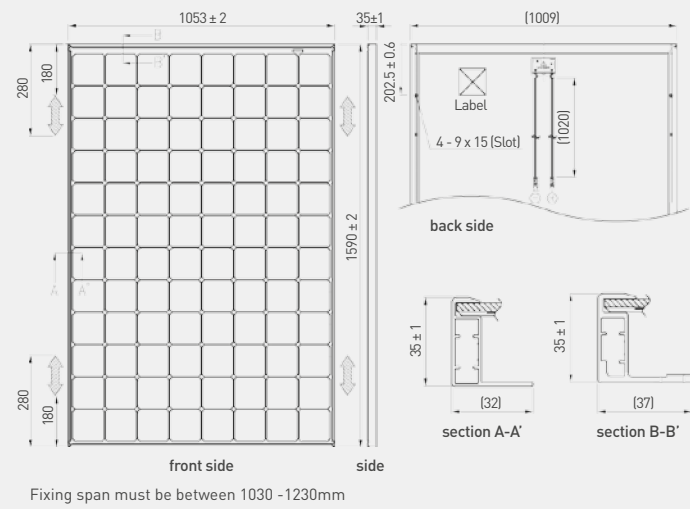

Dependence on irradiance

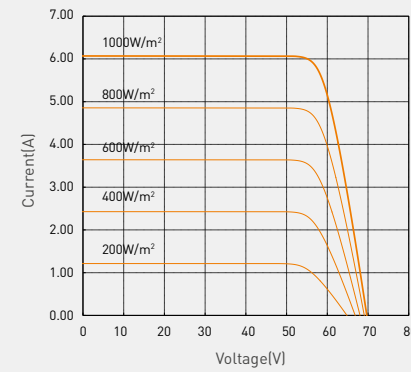

Reference data for model VBHN330SJ47
(Cell temperature: 25°C)

Photovoltaic module HIT® N295

weight: 18 kg
weight/m²: 11.7 kg/m
unit: mm

Snow and Wind Load : 2400 Pa

Dimensions and weight

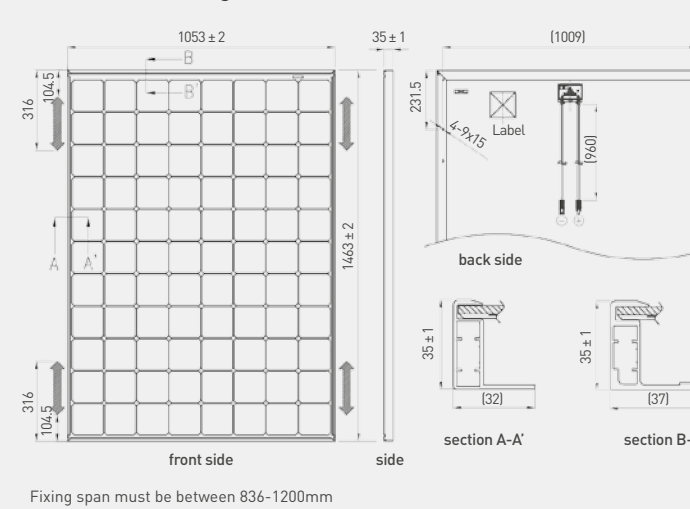

Dependence on irradiance

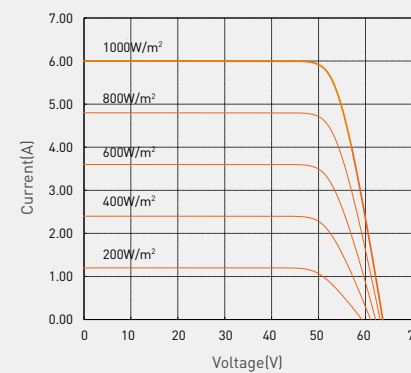

Reference data for model VBHN 295SJ46
(Cell temperature: 25°C)

Photovoltaic module HIT® N245

weight: 15 kg
weight/m²: 11.9 kg/m
unit: mm

Snow and Wind Load : 2400 Pa

Dimensions and weight

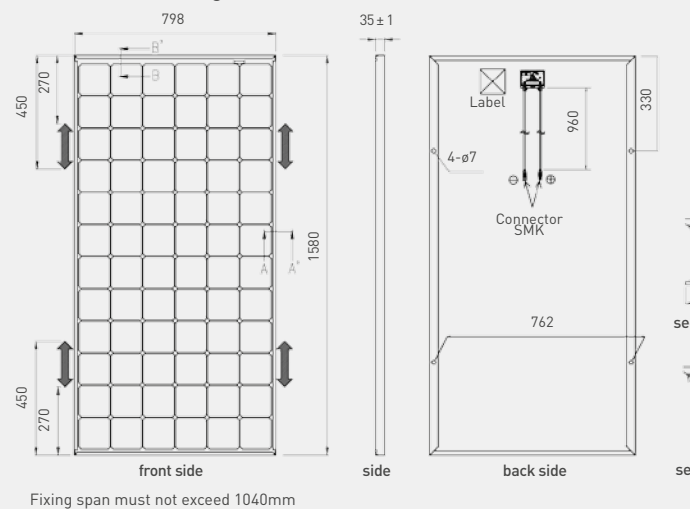

Dependence on irradiance

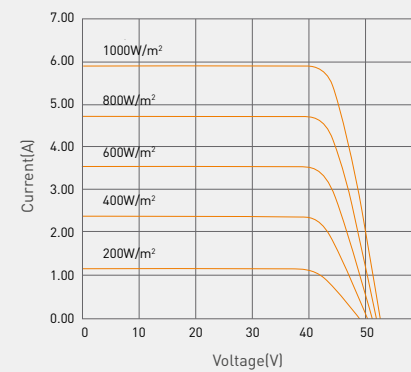

Reference data for model VBHN245SJ25
(Cell temperature: 25°C)

Electrical data (at STC)

	VBHN330SJ47	VBHN295SJ46	VBHN245SJ25
Max. power (Pmax) [W]	330	295	245
Max. power voltage (Vmp) [V]	58.0	52.7	44.3
Max. power current (Imp) [A]	5.70	5.60	5.54
Open circuit voltage (Voc) [V]	69.7	63.7	53.0
Short circuit current (Isc) [A]	6.07	6.00	5.86
Max. over current rating [A]	15	15	15
Power tolerance [%] *	+10/-0	+10/-0	+10/-0
Max. system voltage [V]	1000	1000	1000
Solar Panel efficiency [%]	19.7	19.1	19.4

Note: Standard Test Conditions: Air mass 1.5; Irradiance = 1000W/m²; cell temp. 25°C.
* Maximum power at delivery. For guarantee conditions, please check our guarantee document.

Temperature characteristics

	VBHN330SJ47	VBHN295SJ46	VBHN245SJ25
Temperature (NOCT) [°C]	44.0	44.0	44.0
Temp. coefficient of Pmax [%/°C]	-0.29	-0.29	-0.29
Temp. coefficient of Voc [V/°C]	-0.174	-0.159	-0.133
Temp. coefficient of Isc [mA/°C]	1.82	1.80	1.76

Note: Normal Operating Cell Temp.: Air mass 1.5; Irradiance = 800W/m²; Air temperature 20°C; wind speed 1 m/s

At NOCT (Normal Operating Conditions) (Tentative)

	VBHN330SJ47	VBHN295SJ46	VBHN245SJ25
Max. power (Pmax) [W]	251.9	224.3	187.4
Max. power voltage (Vmp) [V]	56.3	50.8	42.5
Max. power current (Imp) [A]	4.54	4.48	4.41
Open circuit voltage (Voc) [V]	65.8	60.2	50.3
Short circuit current (Isc) [A]	4.89	4.83	4.71

Note: Low irradiance: Air mass 1.5; Irradiance = 200W/m²; cell temp. = 25°C

At low irradiance (20%) (Tentative)

	VBHN330SJ47	VBHN295SJ46	VBHN245SJ25
Max. power (Pmax) [W]	63.5	56.8	47.0
Max. power voltage (Vmp) [V]	57.0	51.5	43.2
Max. power current (Imp) [A]	1.12	1.10	1.09
Open circuit voltage (Voc) [V]	65.6	59.7	49.6
Short circuit current (Isc) [A]	1.22	1.20	1.17

Guarantee

Power output: 10 years (90% of Pmin)
25 years (80% of Pmin)
Product workmanship: 25 years (online registration required: www.eu-solar.panasonic.net)

Materials

Cell material: 5 inch photovoltaic cells
Glass material: AR coated tempered glass
Frame materials: Black anodized aluminium
Connectors type: SMK

IEC61215
IEC61730-1
IEC61730-2



CLASS UNO
By TÜV Rheinland
UNI 8457
UNI 9174
UNI 9177

This catalogue ends. Our partnership continues.

Get a free quote at panasonic.ezzing.com!

Find a Panasonic Solar Premium Installer in your area:

www.eu-solar.panasonic.net/en/premium-installer-panasonic-map-search.htm

To become a Panasonic Solar Premium Installer at, please register here:

www.eu-solar.panasonic.net/en/premium-installer-register.htm

Panasonic[®]

Panasonic Eco Solutions Europe

Panasonic Electric Works Europe AG

Robert-Koch-Straße 100 · 85521 Ottobrunn · Germany

Tel. +49 89 45354-1000 · Fax +49 89 45354-2111

info.solar@eu.panasonic.com

www.eu-solar.panasonic.net

