

integrated fixing point **ROOFTRAK™**

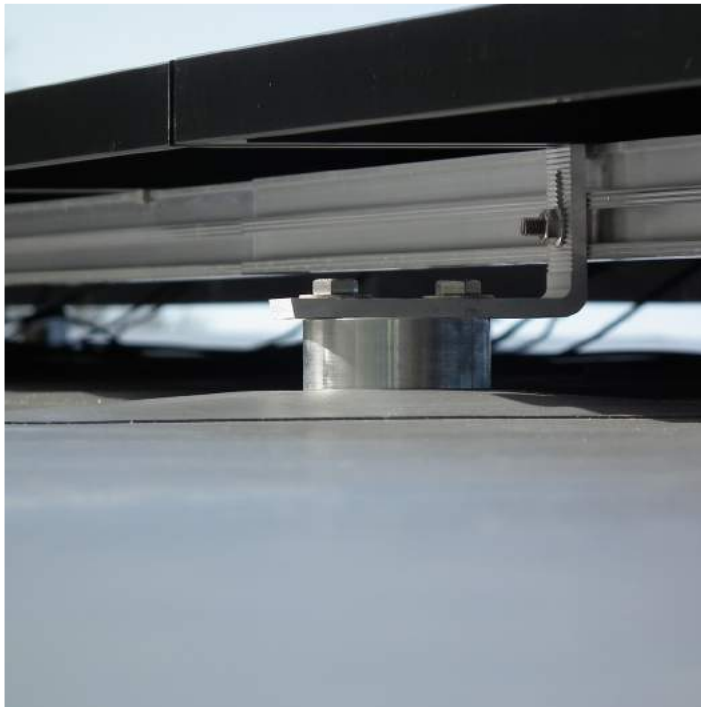



'The IFP is revolutionising the way we fix things to roofs.'

Technical Director of a leading UK roofing system manufacturer

The ROOFTRAK-IFP

A revolutionary solution to an old problem

Fixing anything to a roof always presents a challenge in a similar way to any other operation that involves making a penetration through a roof covering, especially flat roofs.

What if it leaks?

A roof is there to keep the elements outside, and increasingly, the warmth inside. The building owner and occupier alike need to know that the roof installation will continue this important function as expected and that no surprises await during the expected life span of the roof.

As a result, an increasing number of new and refurbished roof coverings are specified and installed with a manufacturers warranty giving peace of mind. Many of these manufacturers operate a strict installation routine with approved installers fitting approved materials to approved methods and practices. These measures are designed to control and eliminate as far as possible the risk of leaks and water ingress in the roof membrane.

The problem

The roof area is an ideal area to site many parts and components of the building's mechanical services equipment that are essential to the buildings use.

These components include air conditioning units, condensers, chillers, general roof plant, pipework and solar panels. Any effort to fix these items to the roof structure involves a potential threat to the integrity of the roof covering. Solar panels in particular, due to their size and location, are vulnerable to wind forces. In some case ballasted systems can be used to secure them in position but this depends upon the height of the building, it's location and the strength of the roof structure to be successful. Often the best solution is to mechanically fix them to the roof structure.

The IFP solution

The Integrated Fixing Point can be used with nearly all roof membranes including bituminous and single ply types such as SBS PVC, TPO, EPDM etc.

It is supplied as a factory assembled unit pre-fitted with the correct membrane enabling full integration with the roof system it is being installed on.

It provides a universal fixing offering two M10 x 20 female threaded anchor points for supporting and securing most types of rails and bars. Multiple fixings can be made directly to the roofing structure providing excellent pull out values into most substrates.

All the fixings are sealed under the flange of the IFP against water ingress using the same horizontal lap joint that the rest of the roof is installed with.

Compatibility

The IFP has been approved by leading roof system manufacturers for use with their roofing systems. Where a technical approval does not exist Nicholson can provide a supplementary warranty for the seal of the IFP. In most cases, the use of the IFP will not invalidate a manufacturers warranty - see Design Considerations on page 6 for further information.





integrated fixing point ROOFTRAK™

Flange

The flange material is factory fitted and the IFP is supplied as a complete unit including fixing point, flange and fixing plate.

The flange material fitted to the IFP must be the same as, or compatible with, the roof upon which the IFP is being fitted.

Fixing Point

A 76mm Ø stainless steel support patrice with 2 no female M10 x 20mm anchoring points

Fixing Plate

The coated steel fixing plate provides for multiple fixings which are covered by the flange material and effectively within the waterproof zone under the sealing layer of the roofing system.

There are both 7mm and 17mm Ø holes for direct and thermally broken fixing types.

The use of multiple fixings often means that it is not necessary to locate the IFP directly over a structural member such as a joist or purlin giving greater flexibility to the installer in siting and layout.

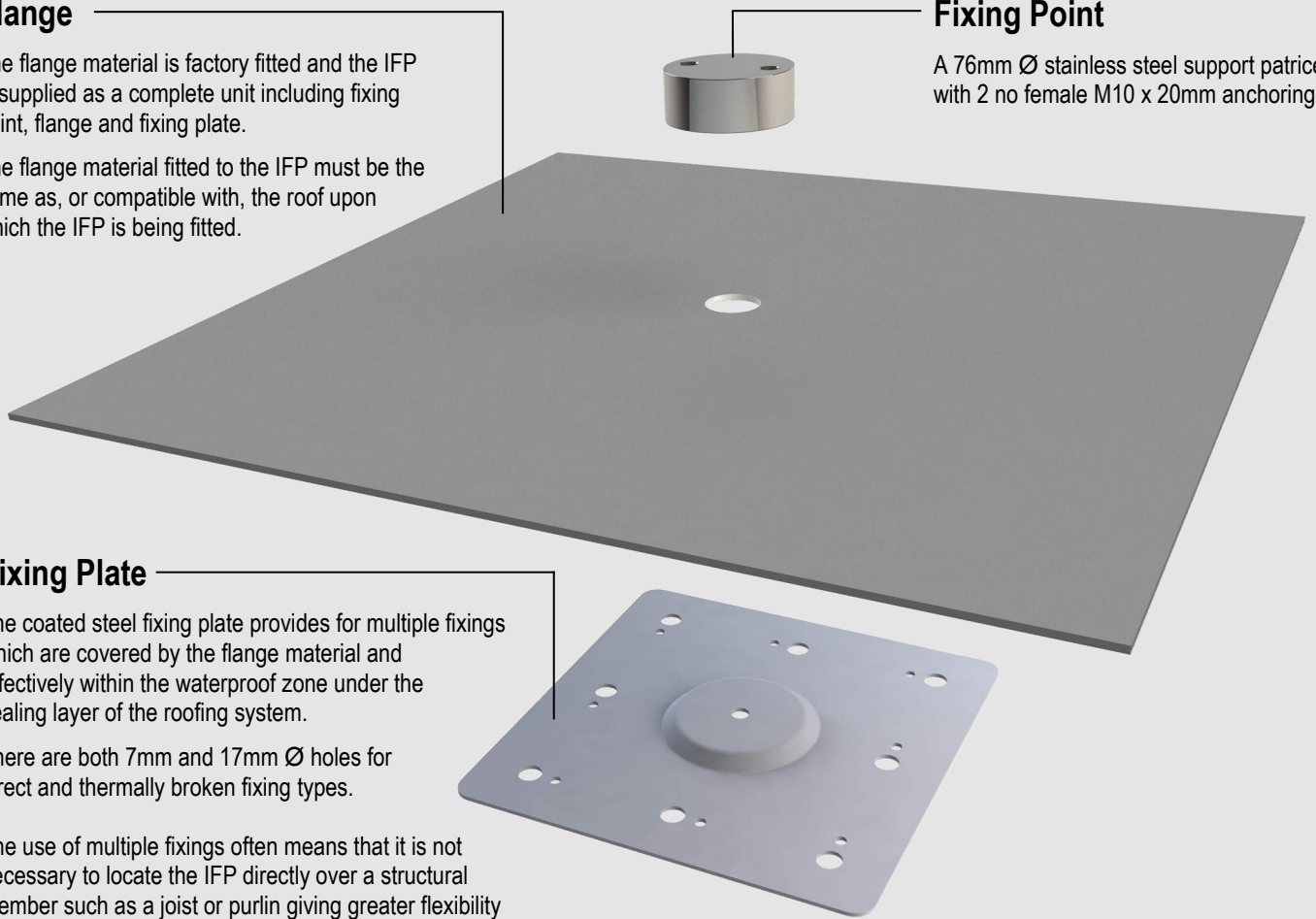

The seal and CPT™(Constant Pressure Technology)

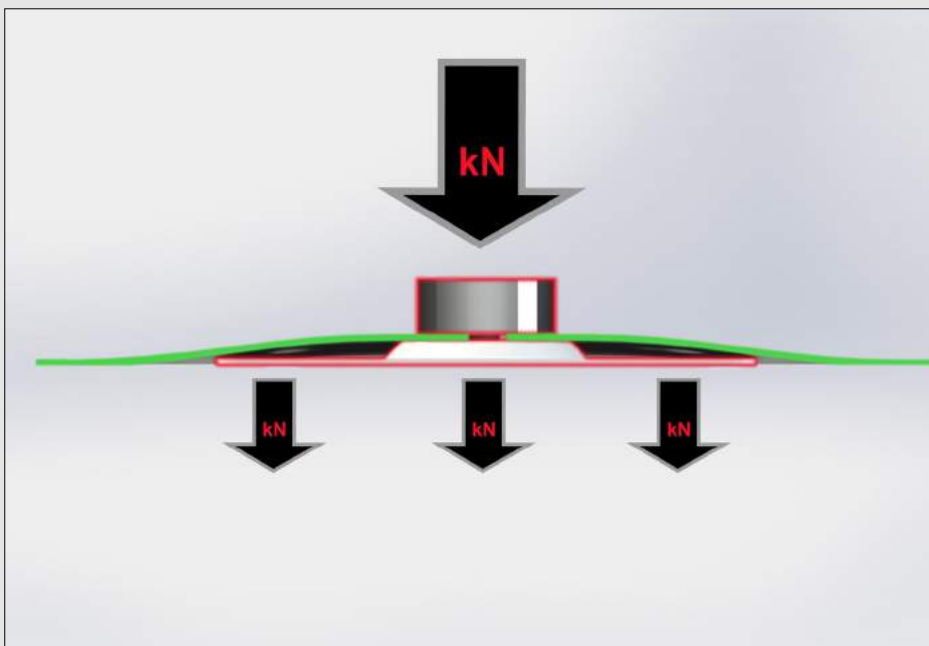

The IFP uses the simple principle of a washer to effect a mechanical seal to seal to the flange. The flange or roofing membrane becomes the washer meaning that there is no gasket, glue, sealant or other perishable part utilised and the seal will last as long as the membrane does. This principle has been tested by Nicholson to air pressures of 2 bar with zero drop.

Rather than an uncontrolled compression of the flange, Nicholson has developed CPT™ or Constant Pressure Technology.

This patented mechanism ensures that the membrane is sealed and subjected to a controlled compression which remains constant even when under loadings from roof plant, wind uplift and snow.

All forces applied to the fixing point are transferred directly to the fixing plate without affecting the roofing membrane flange.

The IFP is protected design and subject of a pending patent application - any design infringement will be addressed in the strongest manner appropriate.

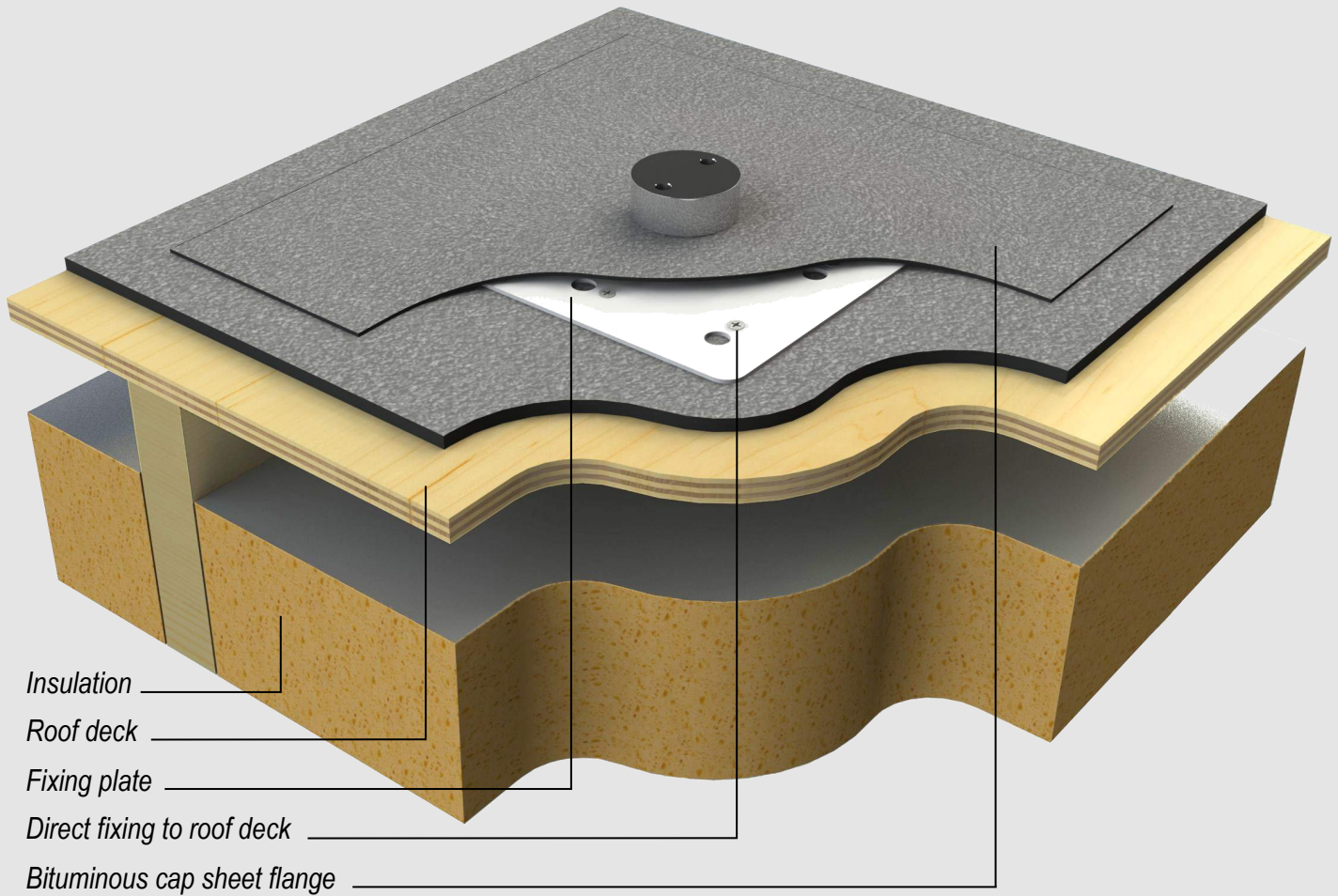

Cold Roof Constructions

The IFP can be fitted to cold roof constructions with either single ply or bituminous membranes and in new build or retrofit situations.

In cold roof constructions the IFP is normally fixed directly to the roof deck using the 7mm Ø holes in the fixing plate. It is suggested that all fixing holes are used to achieve the maximum uplift values.

Subject to calculations and testing it is often the case that the IFP units can be positioned with no reference to the structural supporting members within the roof construction eg joists or purlins.

Where used with bituminous roofing systems it is suggested that the IFP is fitted with cap sheet although underlay sheets can be used. In both cases, a reinforced sheet is required.

For fitting instructions see page 6 and for Technical Data see page 7.



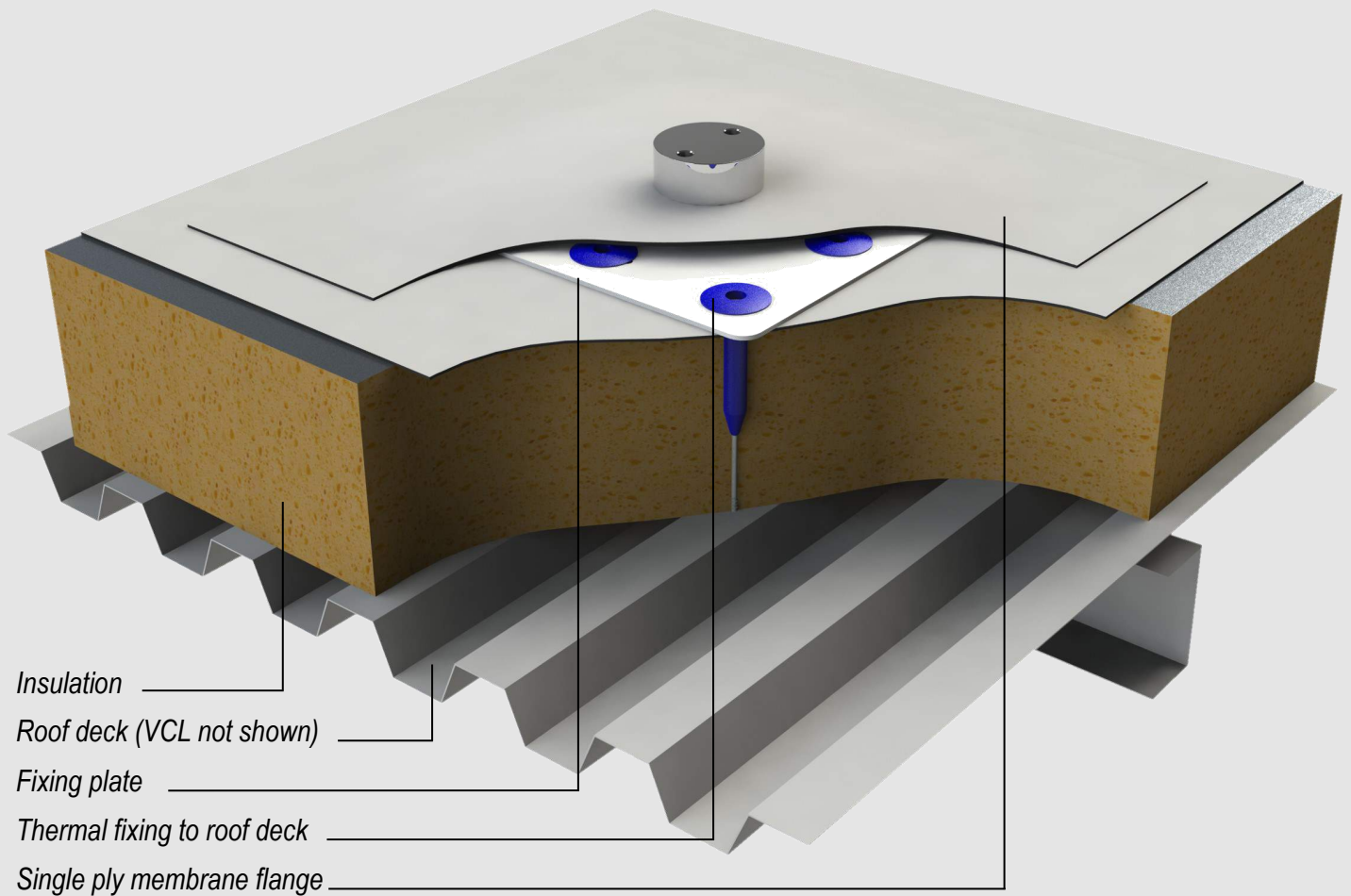

Warm Roof Constructions

The IFP can be fitted to warm roof constructions with either single ply or bituminous membranes and in new build or retrofit situations.

In warm roof constructions the IFP is normally fixed through the completed roof and insulation into the roof deck using either the 7mm Ø holes for direct type fixings or the 17mm Ø holes for thermally broken type fixings. It is suggested that as many as possible of the fixing holes are used to achieve the maximum uplift values.

Subject to calculations and testing it is often the case that the IFP units can be positioned with no reference to the structural supporting members within the roof construction eg joists or purlins.

Where used with single ply roofing systems it is important that the IFP is fitted with the same membrane that the main roof is weathered in to avoid any compatibility issues.

For fitting instructions see page 6 and for Technical Data see page 7.



Design Considerations

- 1) **Quantity** - the number of IFP's required for a particular application will be affected by various factors some of which are outlined below.
- 2) **Loading** - the IFP units will support varying downward loads depending upon the substrate they are mounted upon. For cold roof constructions calculations will be required to ensure that the proposed loadings can be supported by the roof or wall structure in question. The same applies for warm roof constructions except that the insulation manufacturers static load rating may affect the load bearing capacity of the IFP.
- 3) **Uplift** - the IFP units depend upon the type and number of fixings used to secure them in position. Where a profiled roof deck is used, the maximum number of fixings may be reduced - see Fitting Instructions below. The fixing manufacturers pull out values in various substrates are a guide but it is suggested that the actual pull out values are tested on site for accuracy.
- 4) **Supporting rails** - where supporting rails are fixed to the IFP units, consideration must be given to the strength of these rails and the centres at which they require supporting to perform in accordance with expectations.
- 5) **Location** - the geographical location, height and other physical constraints will need to be taken account of in any design involving the use IFP's.
- 6) **Minimum no** - a minimum no of 2 IFP's must be used for all applications
- 7) **Warranty for branded IFP's** - where a branded IFP is purchased as part of a roof system it will be covered by the warranty supplied by the roofing manufacturer.
- 8) **Warranty for IFP's purchased from Nicholson** - where the IFP is used on a roofing system and purchased from Nicholson the following is normally the case. The roofing manufacturers warranty is not rendered invalid by the inclusion of the IFP so long as a) the manufacturer's membrane is fitted to the IFP and b) it is weathered by a contractor approved by the roofing system manufacturer. If required, a warranty can be obtained from Nicholson to cover the seal between the membrane and the fixing point but excluding the lap joint seal. Conditions apply - further details upon request.

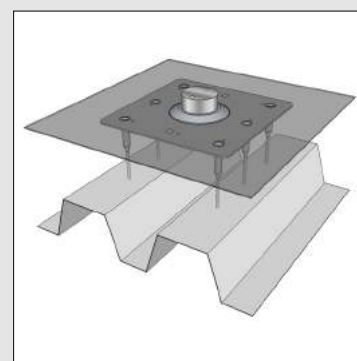

Fitting Instructions

- 1) **Sequence** - the IFPs are designed to be fitted over the completed weathering layer of the roof on which they are to be used.
- 2) **Inspection** - the IFP is supplied in packaging designed to protect it from damage. Prior to installation, the IFP should be checked for defects, especially damaged membrane. If a unit is damaged, do not install it but return to Nicholson for evaluation.
- 3) **Setting out** - where for loading purposes it has been established that the IFP's should be positioned over structural elements eg rafters or purlins, these should be identified and the IFP's set out and located accordingly.
- 4) **Framing** - in addition to 1) above the IFP's should be positioned on the roof taking into account the constraints of any framing system that will be fitted to them. Particular care should be taken to get the orientation of the two fixing points correct as this cannot be adjusted once the IFP has been installed.
- 5) **Fixing on cold roof constructions** - ensure that the fixings used will penetrate the roofing membrane or layer and the roof deck below in accordance with the manufacturers tolerances. Use all available fixing holes to achieve the maximum pull-out value.
- 6) **Fixing on warm roof constructions** - ensure that fixings of sufficient length to penetrate the insulation and the roof deck are used in accordance with the fixing manufacturers instructions. Use as many fixing points as possible to achieve the maximum pull-out value.
- 7) **Metal roof decks** - where the roof deck is a profiled metal deck, the fixings must only be into the crown of the profile. This means that a maximum of six fixings can be used - see diagram. care should be taken to identify and locate the positions of the crowns before fixing commences.
- 8) **Weathering** - the flange of the IFP should be sealed to the roof deck in accordance with the roofing system manufacturers recommendations for lap joints of their particular roof system.
- 9) **Health & Safety** - all regulations applicable to working at height and roof work in general should be followed. Once installed, the IFP can pose a trip hazard. Use the warning sign supplied with the fitting and position so that site operatives are warned before entering that particular area

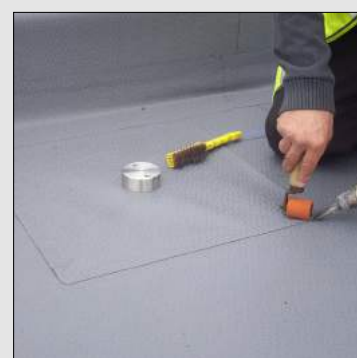
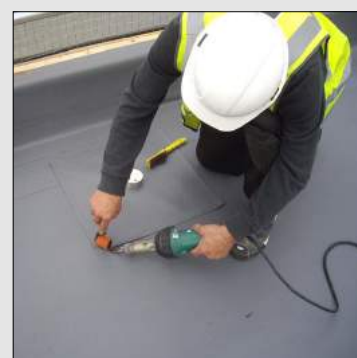

Technical Data

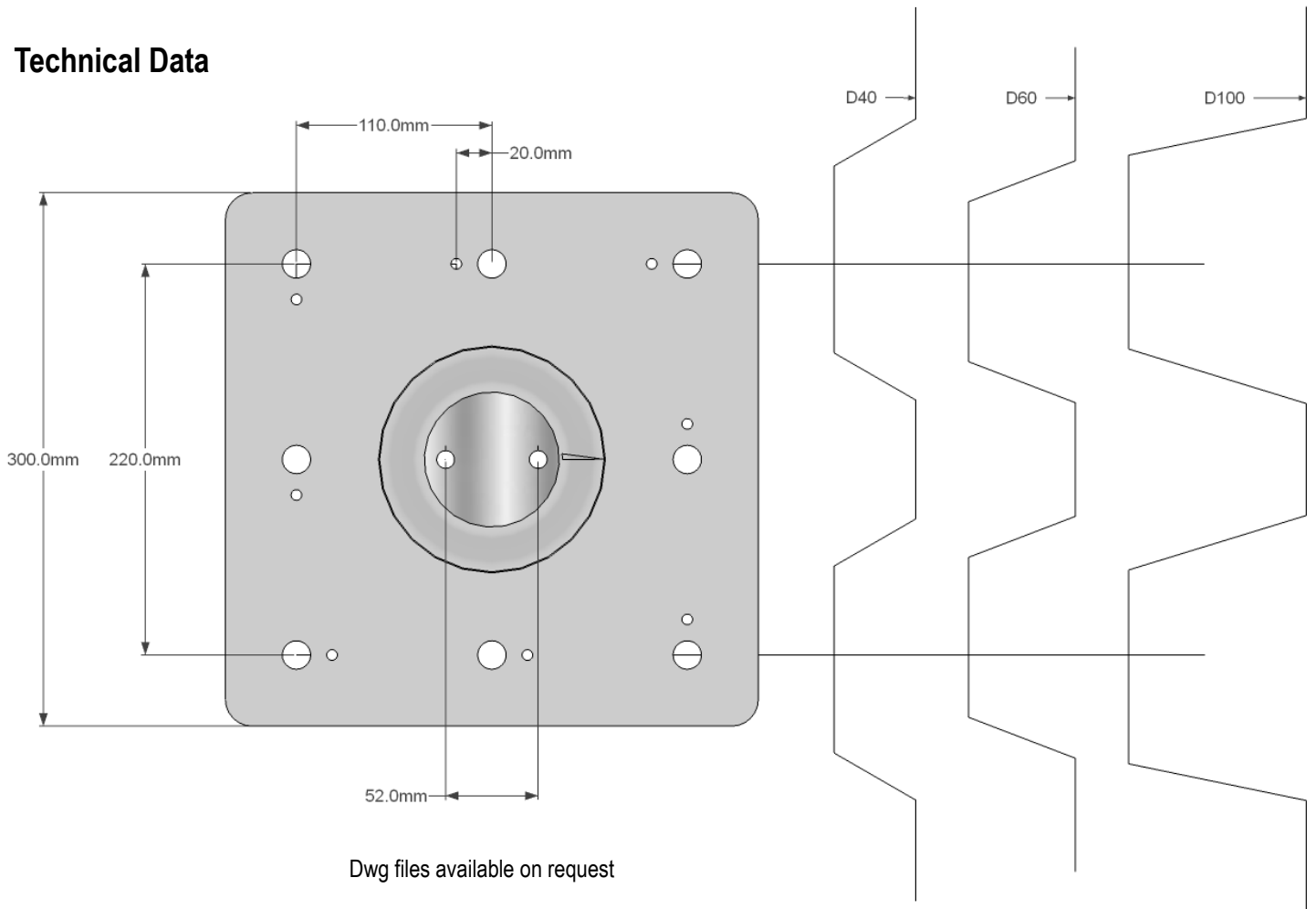

Static loadings in Kg					
Insulation manufacturers long term static load ratings*	20Kpa	30Kpa	40Kpa	50Kpa	60Kpa
IFP loading capacity per post in kg	125kg	187kg	250kg	312kg	375kg
Typical Uplift Values in kN**			No of fixings per unit (safety factor of 3)		
Substrate type	Thickness	kN per fixing	4 no fixings	6 no fixings	8 no fixings
Steel decking	0.7mm	1.6	2.1kN	3.2kN	4.2kN
	0.9mm	2.2	2.9kN	4.4kN	5.0kN
	1.2mm	2.7	3.6kN	5.0kN	5.0kN
	1.6mm	4.0	5.0kN	5.0kN	5.0kN
Plywood	18mm	2.2	2.9kN	4.4kN	5.0kN
OSB	18mm	2.2	2.9kN	4.4kN	5.0kN
Softwood boarding	25mm	3.4	4.5kN	5.0kN	5.0kN
Softwood joist	35mm embedment	4.1	5.0kN	5.0kN	5.0kN
Concrete	25mm embedment	4.1	5.0kN	5.0kN	5.0kN
Unit weight (approx)	Fitted with 1.5mm single ply 3.4 kg		Fitted with SBS torch on membrane 3.65 kg		
* Consult insulation manufacturer for static load rating					
** Based on the Fixfast HD-6.1 range of fasteners. The above values are typical test results and do not include safety factors and intended as a guide only. On-site pullout tests should be carried out to determine the actual uplift values.					
Please note that Nicholson do not undertake structural calculations.					



This brochure...

 integrated fixing point
ROOFTRAK™

Other Nicholson products...

 roof penetration fittings
ROOFPORT™

 roof cabinets
ROOFBOX™

 roof void ventilation
AIRTRAK™

 roof identification and signage
ROOFMARK™

Tel 0845 0098 980
Fax 0845 6588 980
Email info@nicholsonsts.com
Web www.nicholsonsts.com
Post Unit 2, Queens Road, Barnet, Hertfordshire. EN5 4DN

 roof products
NICHOLSON